

PADERNO[®]

WORLD CUISINE

PARTNER OF THE BEST CUISINE

HORECA PRICEBOOK
2025

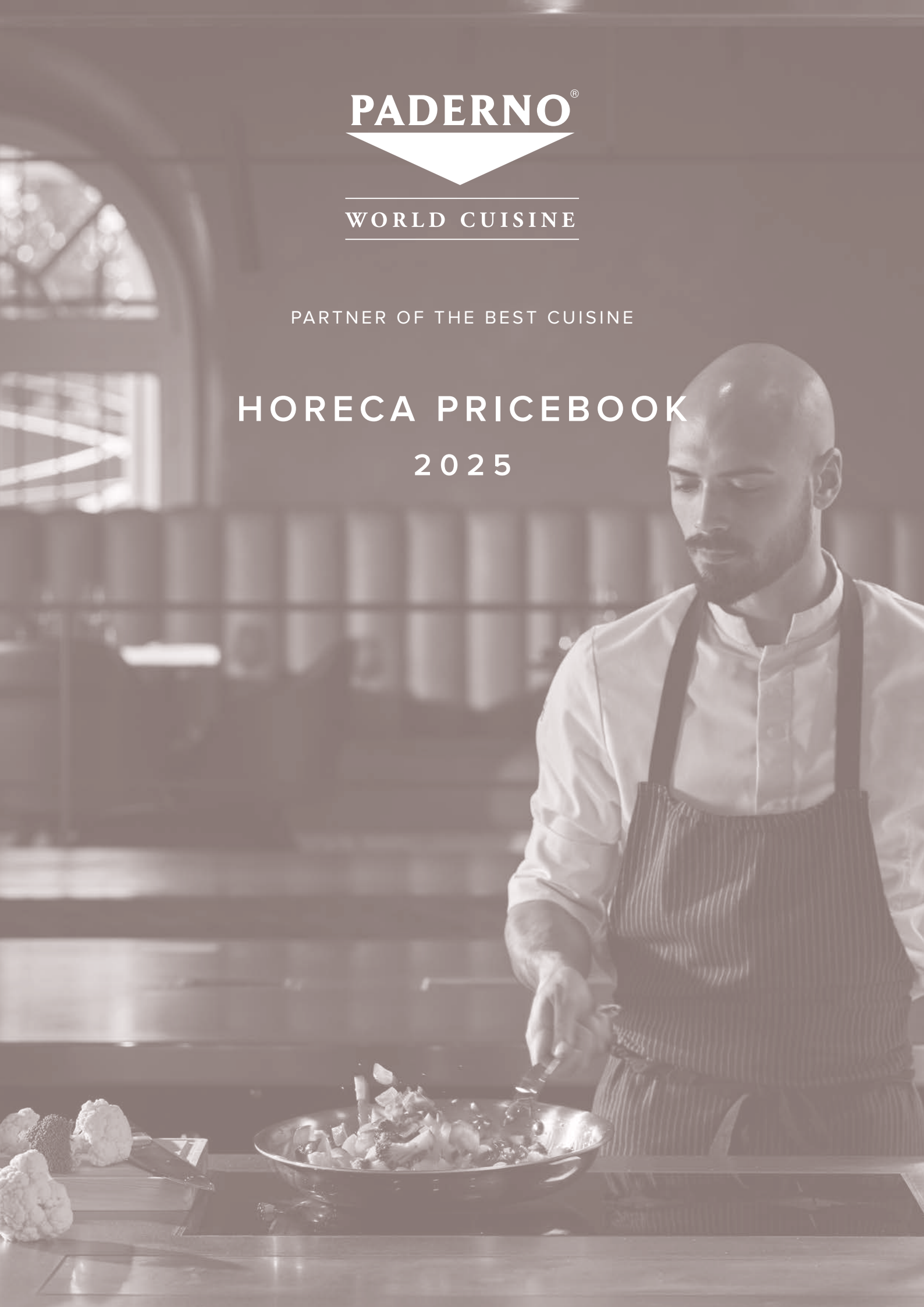



PARTNER OF THE BEST CUISINE

With over 90 years of history and a worldwide presence, Paderno is the benchmark for the professional catering industry and for every cooking enthusiast.

More than 10.000 items, **a complete range for every need in the kitchen**, dedicated to chefs and passionate gourmands. In addition to the production items, the brand offers a remarkable range of complementary articles, carefully selected, and crafted by highly qualified companies.

Forte di oltre 90 anni di storia e di una presenza capillare in tutto il mondo, Paderno è il punto di riferimento per il settore della ristorazione professionale e per ogni appassionato di cucina.

Oltre 10.000 prodotti, **una gamma completa per ogni esigenza in cucina**. Le linee di strumenti Paderno sono ideate per unire praticità d'utilizzo a efficienza e stile. Agli articoli di produzione il brand affianca un'importante gamma di prodotti complementari e affini, accuratamente selezionati e realizzati da ditte altamente qualificate.

PADERNO[®]



WORLD CUISINE

OUR HISTORY

1925

THE ESTABLISHMENT LA FONDAZIONE

The company was established in 1925 in Paderno Dugnano, a few kilometers from Milan. The brand, then known as Alluminio Paderno, specialized in **home cooking and aluminum cookware.**

Il brand trova le sue origini nel 1925 a Paderno Dugnano, a pochi km da Milano. L'azienda, allora nota come Alluminio Paderno, si specializza nel settore della **cucina casalinga e del pentolame in alluminio.**

Orfengo Headquarter, opened in 1997





1979

FOCUS ON PROFESSIONALS
AL SERVIZIO DEI PROFESSIONISTI

During the 1970s, the company was taken over by the entrepreneurial brothers Pierluigi and Franco Coppo. Improved production and quality standards ensured a wide and varied offer. The company is relaunched and **emerges in the hotel market** and catering supplies.

Durante gli anni '70 l'azienda viene acquisita dai fratelli imprenditori Pierluigi e Franco Coppo. Migliorando gli standard di produzione e qualitativi viene così garantita un'ampia e variegata offerta. L'azienda viene rilanciata ed **emerge nel mercato alberghiero** e delle forniture per la ristorazione collettiva.

Our partner Alfredo Russo, Michelin-starred chef



OUR HISTORY

1997

-

1999

THE NEW HEADQUARTER IL NUOVO QUARTIER GENERALE

In 1997, Paderno acquired Sambonet - a historic brand of cutlery and table accessories - and in 1999 the new headquarters and production plant was inaugurated. An **eco-friendly architecture**, harmoniously set in nature, designed by architect Enrico Frigerio.

Nel 1997 Paderno acquista Sambonet - storico marchio di posate e accessori tavola - e nel 1999 viene inaugurata la nuova sede e stabilimento produttivo. **Un'architettura ecocompatibile** inserita armoniosamente nella natura, disegnata dall'architetto Enrico Frigerio.



2006

AWARD FOR EXCELLENCE PREMIO ECCELLENZA

Sambonet Paderno Industrie S.p.A. received the **Award for Excellence for Innovation** by Confindustria (the main organization representing Italian manufacturing and services companies) with reference to the framework for innovation of the EFQM–European Foundation for Quality Management.

Sambonet Paderno Industrie S.p.A. è stata insignita dell'**Award for Excellence per l'innovazione**, rilasciato da Confindustria in riferimento al framework per l'innovazione dell'EFQM–European Foundation for Quality Management.



2009

-

2015

ARCTURUS GROUP
IL GRUPPO ARCTURUS

In 2009, Sambonet Paderno Industrie acquired the prestigious German porcelain brand Rosenthal, followed by the Bavarian Arzberg in 2013 and the French Ercuis and Raynaud in 2015. Thanks to the entrepreneurship of brothers Pierluigi and Franco Coppo, the **Arcturus group is now an international leader** in the dining, kitchen, and home living business.

Nel 2009 Sambonet Paderno Industrie acquisisce il prestigioso brand di porcellane tedesco Rosenthal, cui segue la bavarese Arzberg nel 2013 e le francesi Ercuis e Raynaud nel 2015. Grazie all'imprenditorialità dei fratelli Pierluigi e Franco Coppo, il **Gruppo Arcturus è oggi leader internazionale** nel mondo tavola, cucina e home living.

Pierluigi, Alessandra, Giovanni and Franco Coppo



GREEN & SUSTAINABILITY

SUSTAINABILITY, TRANSPARENCY AND AWARENESS ARE KEYWORDS OF OUR CORPORATE RESPONSIBILITY.

SOSTENIBILITÀ, TRASPARENZA E CONSAPEVOLEZZA SONO LE PAROLE CHIAVE DELLA NOSTRA POLITICA DI CORPORATE RESPONSIBILITY.

CLEAN ENERGY ENERGIA PULITA

In 2022 we activated the new zero-impact solar photovoltaic system, installed on the roof of our factory. **More than 3,000 panels on 6,000 sqm.** The plant can generate an average of 1,250 KW, equal to 30% of the company's annual needs. The plant cuts CO2 emissions into the environment consistently, **the equivalent of 7,500 planted trees in 5 years.** A small but significant contribution to our planet.

Nel 2022 abbiamo attivato il nuovo impianto fotovoltaico a energia solare a impatto zero, installato sulla copertura dello stabilimento. **Oltre 3.000 pannelli su una superficie di 6.000 m².** L'impianto è in grado di generare mediamente 1.250 KW, ossia il 30% del fabbisogno energetico annuo dell'azienda. Lo stabilimento diminuisce così le emissioni di CO2 nell'ambiente in maniera considerevole: **il corrispettivo di 7.500 alberi piantati nell'arco di soli 5 anni.** Un piccolo ma significativo contributo per il nostro pianeta.



10 YEARS OF SUSTAINABILITY REPORT 10 ANNI DI BILANCIO DI SOSTENIBILITÀ

Since 2012 we have published the Sustainability Report every year, a report on our performance through numbers and achieved targets, **a concrete proof of our commitment** and attention to sustainable development.

Dal 2012 pubblichiamo ogni anno il Bilancio di sostenibilità, un report delle nostre performance attraverso numeri e obiettivi raggiunti, **testimonianza concreta del nostro impegno** e attenzione verso uno sviluppo sostenibile.



RESPONSIBLE CONSUMPTION CONSUMO RESPONSABILE

We care about our planet and that is why we set our environmental policy on a responsible consumption and the use of clean and renewable energy sources. **A sustainable and respectful approach to nature** and our territory.

Abbiamo a cuore il nostro pianeta e per questo abbiamo impostato la nostra politica ambientale sul consumo responsabile e sull'utilizzo di fonti energetiche pulite e rinnovabili. **Un approccio sostenibile e rispettoso per la natura** e il nostro territorio.



OUR EFFORTS, EVERY DAY IL NOSTRO IMPEGNO, TUTTI I GIORNI

Beside monitoring water consumption and purification systems, we use energy-efficient LED lighting elements, twilight lamps throughout the plant and controlled thermostats in every office. We have reduced paper consumption by choosing digital archiving, using recyclable materials and separate waste collection in every room. **This is non-stop progress.**

Oltre al monitoraggio del consumo d'acqua e sistemi di purificazione, impieghiamo elementi di illuminazione LED ad alta efficienza energetica, crepuscolari in tutto lo stabilimento e termostati controllati in ogni ufficio. Abbiamo ridotto il consumo di carta scegliendo l'archiviazione digitale, impiegando materiali riciclabili e operando la raccolta differenziata in ogni ambiente. **Un miglioramento non-stop.**

FACTORY

NATURE meets DESIGN

ITALIAN HEADQUARTERS

In 2001, in 9 months, the new headquarter between Vercelli and Novara was built, amounting to 150,000 square meters - equivalent to more than 20 football fields - of which 19,000 square meters for production. In 2004, the new warehouse was expanded to 13,000 square meters, later still to 25,000 square meters. The building - which includes one of the largest galvanic plants in Europe - **meets all production and warehouse requirements, as well as logistics needs**. It is positioned exactly opposite the highway entrance for fast connections to the center of northern Italy.

Developed by the Frigerio Design Group, Slow Architecture is a progressive architecture, living in time and in its context. The parallelism created by the building establishes a geometric correspondence between the Po Valley and the linearity of the façade elevation, which is sensitive to the nuances of the sky and the land through an unprecedented play of colours, with a "screen" of gigantic colored pixels.

Nel 2001, in 9 mesi, viene costruito il nuovo headquarter tra Vercelli e Novara, pari a 150.000 m² - equivalenti a oltre 20 campi da calcio - di cui 19.000 m² di produzione. Nel 2004 viene ampliato il nuovo magazzino a 13.000 m², successivamente ancora a 25.000 m². Lo stabilimento - che include uno degli impianti galvanici più grandi d'Europa - **risponde a tutte le esigenze di produzione e stoccaggio, oltre che di logistica**, posizionato esattamente di fronte all'ingresso autostrale per rapidi collegamenti con il cuore nevralgico del Nord Italia.

Sviluppata dal Frigerio Design Group, la Slow Architecture è un'architettura progressiva, che vive nel tempo e nel contesto in cui s'inserisce. Il parallelismo creato dal nuovo edificio instaura una corrispondenza geometrica tra la Pianura Padana e la linearità del prospetto della facciata, sensibile alle sfumature del cielo e del territorio attraverso un inedito gioco cromatico, con uno "schermo" di enormi pixel colorati.

US HEADQUARTERS

In 2020, the new centralized logistics hub Sambonet Paderno in Randolph, New Jersey was opened. **A key distribution hub in North America**, covering over 6.000 square meters, with 40 employees, sales offices, and a state-of-the-art warehouse with more than 15.000 products.

Nel 2020 è stato inaugurato il nuovo polo logistico centralizzato Sambonet Paderno a Randolph, New Jersey. **Una struttura chiave per la distribuzione dal Nord America**, che si sviluppa su 6.000 m² e riunisce un organico di 40 dipendenti, uffici commerciali e un magazzino di ultima generazione che ospita oltre 15.000 prodotti.

90 EXPORT COUNTRIES

800 SHIPMENTS PER DAY

20.000 KG CHECKED PER DAY

3 CHECKS BEFORE EACH SHIPMENT

17.000 REFERENCES IN STOCK

87 SHIPMENTS WITHIN 48 HOURS FROM THE ORDER

20.000 PIECES PRODUCED PER DAY

40 MODELS OF CUTLERY

5.000 CUTLERY MOLDS

5.000 POTS PRODUCED PER DAY

CERTIFIED QUALITY

ENERGY & GREEN CERTIFICATIONS

Sustainable development and low environmental impact. We adopt **clean and renewable energy sources** such as methane and electricity – as the new photovoltaic system – and resources to be returned to the environment completely intact – as in the case of the groundwater used in our factory, which is constantly analysed and monitored by our in-house laboratory.

Uno sviluppo sostenibile e impatto ambientale contenuto. Adottiamo **fonti energetiche pulite e rinnovabili** quali metano ed elettricità – come per il nuovo impianto fotovoltaico – e risorse da restituire all'ambiente completamente integre – come nel caso dell'acqua di falda impiegata nel nostro stabilimento, analizzata e monitorata costantemente dal nostro laboratorio interno.

SISTEMI DI
GESTIONE CERTIFICATI



UNI EN ISO 9001:2015
UNI EN ISO 22000:2005

SISTEMA DI GESTIONE
AMBIENTALE CERTIFICATO



UNI EN ISO 14001:2015

SISTEMA DI GESTIONE
DELL'ENERGIA CERTIFICATO



UNI CEI EN ISO 50001:2018

HUMAN & SAFETY CERTIFICATIONS

We define and keep updated **high safety standards in favor of our employees** and the entire working environment, also going beyond the regulations, according to a long-term projection that is indispensable in our Group vision. This policy is widespread in all our production sites and in 2016 it let us earn a special mention from Confindustria and INAL Italia, for the promotion of "Total Safety Management".

Definiamo e aggiorniamo **elevati standard di sicurezza a favore dei nostri dipendenti** e dell'intero ambiente di lavoro, andando anche oltre alle normative vigenti in materia, secondo una proiezione di lungo termine indispensabile nella nostra visione di Gruppo. Questa politica è diffusa in tutti i nostri siti produttivi e già nel 2016 ci è valsa una gratificante menzione speciale da parte di Confindustria e INAL Italia, per la promozione del "Total Safety Management".

SISTEMA DI GESTIONE
SICUREZZA CERTIFICATO



UNI ISO 45001:2018

FOOD, PRODUCTION & SHIPPING CERTIFICATIONS

Our products are safe for food contact thanks to **quality requirements observed along the entire supply chain**. From the application of HACCP to the hygienic-sanitary regulations established by the highest international standard, up to packaging in compliance with customs standards, for **fast shipping and delivery**.

Ogni nostro prodotto è sicuro per il contatto alimentare grazie a **requisiti qualitativi tracciati lungo l'intera filiera**. Dall'applicazione dell'HACCP alle normative igienico-sanitarie stabilite dal più alto standard internazionale, fino anche all'imballaggio in rispetto agli standard doganali, per una **rapida spedizione e consegna**.

SISTEMI DI
GESTIONE CERTIFICATI



UNI EN ISO 9001:2015
UNI EN ISO 22000:2005



IT AEOF 09 0064



LAB CERTIFICATIONS



LABORATORIO DI ANALISI
INTERNO CERTIFICATO



LAB N°1407

Thanks to our certified Accredia laboratory, ASEC Lab – Alimentary Security Control, **we can guarantee the suitability and safety of each of our articles** placed on the market, both direct and distributed. We can also issue conformity declarations on steel, aluminum, porcelain, glass, plastic, and colorants internationally recognized. The ASEC Lab is also accredited to determine pH levels, solvents and metals in water discharge, a guarantee for the internal analysis of the wastewater quality.

Grazie al nostro laboratorio certificato Accredia, ASEC Lab – Alimentary Security Control, **siamo in grado di garantire l'idoneità e la sicurezza di ciascun nostro articolo** immesso sul mercato, sia di produzione diretta che distribuito. Siamo inoltre autonomi per il rilascio di dichiarazioni di conformità su acciaio, alluminio, porcellana, vetro, materiali plastici e coloranti, riconosciute a livello internazionale. ASEC Lab è inoltre accreditato per la determinazione di pH, solventi e metalli nelle acque scarico, una garanzia per le analisi interne sulla qualità delle proprie acque di scarico.

SR:10 SOCIAL RESPONSIBILITY



Thanks to the Corporate Social Responsibility requirements we have pursued over the years and the commitment required also from international suppliers and partners, we are now able to offer **guarantees to our stakeholders**, customers, employees, the market, the community, and the territory as well as institutions and authorities. It means further protection in respect of the common interests and in consideration of the principles of legality and protection of human rights.

Grazie ai requisiti perseguiti negli anni in ambito di Responsabilità Sociale d'Impresa e l'impegno richiesto anche a fornitori e intermediari con i quali lavoriamo in ambito internazionale, siamo oggi in grado di offrire **garanzie oggettive ai nostri stakeholder**, a clienti, dipendenti, al mercato, alla comunità e al territorio fino a enti e istituzioni. Una tutela ulteriore nel rispetto dei loro dell'interesse di tutti e in considerazione dei principi di legalità e salvaguardia dei diritti umani.

EMPLOYEE WELFARE BENESSERE DEI DIPENDENTI



Becoming one of the pioneers in the area, we have joined the European WHP Network (Workplace Health Promotion) to spread the importance of protecting the psychophysical health, through the **promotion of a wholesome lifestyle mentally, physically, and emotional**. We proactively work to offer our employees purchase agreements for goods and services and facilitations for reconciliation of professional and personal life.

Affermandoci tra i pionieri del territorio, siamo entrati a far parte della Rete Europea WHP (Workplace Health Promotion) per diffondere al nostro interno l'importanza e salvaguardia della salute psicofisica, con la **promozione di uno stile di vita corretto in ambito alimentare, sportivo ed emotivo**. Ci adoperiamo proattivamente per offrire ai nostri dipendenti convenzioni per acquisti di beni e servizi e agevolazioni per conciliazione tra vita professionale e personale.

FOLLOW US





M A D E T O S H I N E

Paderno has always been by professionals' side, so that the "star" in each of them can finally "shine". This is the philosophy behind the new brand communication campaign. Every day in the kitchen is a challenge, in which you must manage space, time and tools. **Paderno Made to Shine reveals the magic of those moments**, with a flawless cooking performance by a Michelin-starred chef or with the show by a flair bartender during a mixology event.

Paderno è da sempre al fianco di tutti professionisti, affinché la "stella" presente in ciascuno di loro possa finalmente "splendere". Questa la filosofia dalla quale prende vita la nuova campagna di comunicazione del marchio. In cucina ogni giorno è una sfida, nella quale occorre gestire spazi, tempi e strumenti. **Paderno Made to Shine svela la magia di quei momenti**, dalla rigorosa performance ai fornelli di uno chef stellato, allo spettacolare show di un barman acrobatico durante un evento mixology.

WINNER
INTERACTIVE KEY AWARD 2022
VIDEO "MADE TO SHINE" B2B

SCAN QR CODE



www.paderno.it



AT YOUR SERVICE



ITALIAN SHOWROOM

A new, functional, and welcoming showroom is open at the Orfengo site, Italy. Not only does it illustrate the product range at its best, it also provides inspiration on set-ups and allows you to 'touch' the quality of Sambonet Paderno Industrie. Ask for an appointment to schedule a visit.

Nella sede di Orfengo è attivo **un rinnovato spazio espositivo, funzionale e accogliente**. Ambienti che illustrano al meglio non solo la gamma di prodotti, ma offrono ispirazione sugli allestimenti e permettono di "toccare con mano" la qualità di Sambonet Paderno Industrie. Richiedi un appuntamento per fissare una visita.



ARCTURUS LAB IN MILAN

In November 2022, the Group inaugurated its new showroom in the Bovisa area, redeveloping the old Officine Coppo - the place where the roots of Arcturus' history lie. **A showroom intended to meet the international clientele**, and where professionals, designers and architects can give life to kitchen and table projects, especially for the Contract sector.

A novembre 2022 il gruppo inaugura il nuovo showroom in zona Bovisa, riqualificando le antiche Officine Coppo - luogo in cui risiedono le radici della storia di Arcturus. **Uno spazio espositivo destinato a ricevere la clientela internazionale**, e dove professionisti, designer e architetti possono dare vita a progetti cucina e tavola, in particolare destinato al Contract.

MIAMI SHOWROOM

Still in Novembre 2022 coinciding with Miami Design Week, the US subsidiary is inaugurating an exclusive showroom located in the 'Magic City', the heart of the State of Florida. Approximately 250 sqm where all the Arcturus brands are displayed by a wide selection of table and kitchen range. A vibrant place where chefs, food & beverage managers, architects and interior designers can create **new tailor-made projects, focused on Hospitality and Contract sector**. A reference point also for cruise lines and the Caribbean market.

Sempre a novembre 2022 in occasione della Miami Design Week, la filiale USA inaugura un esclusivo spazio espositivo situato nella cosiddetta "Magic City", cuore pulsante dello stato della Florida. Circa 250 mq dove tutti i brand di proprietà Arcturus sono rappresentati da una ampia selezione di prodotti tavola e cucina, un luogo dinamico nel quale chef, food & beverage manager, architetti e interior designer possono dare vita **a nuovi progetti su misura per l'intero settore dell'Ospitalità e del Contract**. Un punto di riferimento anche per le compagnie di crociera e il mercato caraibico.

CUSTOMER SERVICE

We share our experts' experience at your disposal to help you design and implement the solution you are looking for.

Our staff is highly trained to follow every business need. Contact us and our customer service department will support you at all stages of the purchasing, tracking and after-sales process.

Mettiamo a tua disposizione l'esperienza dei nostri esperti per aiutarti a progettare e realizzare la soluzione che stai cercando.

I nostri collaboratori sono altamente formati per seguire ogni esigenza commerciale. Contattaci e la nostra rete di assistenza ti supporterà al meglio in tutte le fasi del processo di acquisto, tracciabilità e post-vendita.

DIGITAL TRANSFORMATION

We adopted a technology infrastructure for enhanced product information management. Still and images, material description, size and product details: **a comprehensive database of content, accurate and ready for every channel.** Available to partners and customers through a quick and easy online search and download tool.

Abbiamo adottato un'infrastruttura tecnologica per una gestione delle informazioni sui prodotti sempre più performante. Immagini scontornate e ambientate, informazioni sui materiali, misure e dettagli di prodotto: **un database completo di contenuti, accurati e pronti per ogni canale.** A disposizione di partner e clienti attraverso uno strumento online di ricerca e download, semplice e veloce.

INDEX



COOKWARE, POTS & PANS

Pentolame
Kochgeschirr
Batteries de cuisine
Baterías de cocina

22



GN FOOD PANS

Contentitori GN
GN-Behälter
Bacs GN
Cubetas GN

74



KITCHEN UTENSILS

Utensili da cucina
Küchenzubehöre
Ustensiles de cuisine
Utensilios de cocina

101



KNIVES

Coltelleria
Kochmesser
Coutellerie
Cuchilleria

157



PASTRY UTENSILS

Pasticceria
Konditorei-Artikel
La pâtisserie
Pastelería

188



ETHNIC CUISINE

Cucina etnica
Ethnische Küche
Cuisine ethnique
Cocina étnica

276



BAR & ICE - CREAM

Bar e gelateria
Bar u. Eis-Artikel
Bar et glace
Bar y heladería

303



TABLE TOP SERVICE

Tavola
Tischservice
Service de table
Servicio de mesa

377



BUFFET DISPLAY & PRESENTATION

Buffet e presentazione
Buffet und Präsentation
Buffet et présentation
Presentación de buffet

462



CHAFING DISHES / TROLLEYS

Scaldavivande / Carrelli sala
Chafing dishes / Servicewagen
Chafing dishes / Chariots
Chafing dishes / Carros

501



STORAGE, TRANSPORT, CLEANING

Stoccaggio, trasporto, pulizia
Lagerung, Transport, Reinigung
Stockage, transport, nettoyage
Almacenamiento, transporte, limpieza

515



ELECTRIC APPLIANCES

Apparecchi elettrici
Elektrogeräte
Appareils électriques
Aparatos eléctricos

546

GLUTEN FREE - SPARE PARTS

Gluten Free - Ricambi
Glutenfrei - Ersatzteile
Gluten Free - Pièces de rechange
Gluten Free - Repuestos

567

INDEX & SALES TERMS

Indice e condizioni di vendita
Index und Verkaufsbedingungen
Index et conditions de vente
Índice y condiciones de venta

581

ICONS - SIMBOLOGIA - SYMBOLE - SYMBOLES - ICONOS

| | | | |
|---------------------------|---|---------------------------|---|
| ABS | Copolymer, acrylonitrile-butadiene-styrene Copolimero, acrilonitrile-butadiene-stirene | PA+ <i>plus</i> | Polyamide (nylon 6.6) with fiberglass Poliammide (nylon 6.6) con fibra di vetro |
| AG | Silverplated Argentato | PR | Porcelain Porcellana |
| AQ PVD | Antique PVD | PC | Polycarbonate Policarbonato |
| AR | Natural slate Ardesia naturale | PE | Polyethylene Polietilene |
| AY | Acrylic Acrilico | PMMA | Polymethylmethacrylate, plexiglass Polimetilmetacrilato, plexiglas |
| B | Bamboo | PPE | Phenylene ether-expanded polypropylene Etere di polifenilene-polipropilene espanso |
| BC | Bone china | PP | Polypropylene Polipropilene |
| BPA FREE | Without bisphenol A Senza bisfenolo A | PS | Polystyrene Polistirene/polistirolo |
| FE | Metal Metallo | PVD | Physical vapor deposition Deposizione fisica da vapore |
| HDPE | High-density polyethylene Polietilene ad alta densità | R | Natural rattan Rattan naturale |
| MF | Melamine Melamina | SAN | Acrylonitrile-styrene copolymer Copolimero acrilonitrile-stirene |
| MS | Methylstyrene Metilstirene | SMMA | Styrene Methyl Methacrylate Stirene-metilmetacrilato |
| NEW | New Novità | SS | Stainless steel Acciaio inox |
| NSF | NSF certified Certificato NSF | VG | Vintage |
| PA | Polyamide (nylon) Poliammide (nylon) | VG PVD | Vintage PVD |
| | | W | Wood Legno |

ICONS - SIMBOLOGIA - SYMBOLE - SYMBOLES - ICONOS

| | | | |
|---|---|---|--|
|  | Suitable for electric stoves Adatto per fornelli elettrici |  | GN size Misure GN |
|  | Suitable for glass-ceramic stoves Adatto per fornelli in vetroceramica |  | Battery powered Alimentato a batterie |
|  | Suitable for induction stoves Adatto per fornelli a induzione |  | Hand wash Lavare a mano |
|  | Suitable for gas stoves Adatto per fornelli a gas |  | Do not use sharp objects Non usare oggetti taglienti |
|  | For gluten free food Per alimenti senza glutine |  | Do not use on open flames Non utilizzare su fiamme libere |
|  | Coolable Refrigerabile |  | Dishwasher safe Lavabile in lavastoviglie |
|  | Heated Riscaldato |  | No dishwasher safe Non lavabile in lavastoviglie |
|  | Water resistant Resistente all'acqua |  | Microwave safe Idoneo a microonde |
|  | NO water resistant NON resistente all'acqua |  | Oven safe Idoneo a forno |
|  | With light Con luce |  | No microwave safe Non idoneo a microonde |
|  | Food safe Per alimenti |  | No oven safe Non idoneo a forno |
|  | Stackable Impilabile |  | Product that does not comply with the REACH Regulation Prodotto non conforme con la normativa REACH |







SERIES 12200 5-PLY

STAINLESS STEEL COOKWARE
PENTOLAME INOX



Professional and elegant. Stainless steel stay-cool handles, mirror finish, designed to provide a secure and ergonomic grip. Securely attached to the pan with stainless steel rivets. The integral multilaminated body ensures rapid and uniform heating. Interior in 18/10 stainless steel satin finish, 3-ply aluminum core, induction stainless steel mirror finish exterior. Average thickness 2,7 mm. Suitable for use on all cooking hobs including induction.

Professionale ed elegante. Manici in acciaio inox finitura lucida, resistenti al calore e progettati per fornire una presa sicura ed ergonomica. Sono fissati saldamente ai corpi con rivetti in acciaio inossidabile. I corpi integralmente in multilaminato garantiscono un riscaldamento rapido e uniforme. Interno in acciaio inossidabile 18/10 satinato, anima in alluminio trilaminato, esterno in acciaio inossidabile per induzione con finitura a specchio. Spessore medio 2,7 mm. Adatta per l'uso su tutti i piani cottura compresa l'induzione.



Saucepan

Casseruola alta
Stielkasserolle
Casserole haute
Cazo recto alto

| art. | Ø cm. | h. cm. | lt. | € |
|----------|-------|--------|-----|-------|
| 12206-16 | 16 | 8,0 | 1,4 | 68,34 |
| 12206-18 | 18 | 8,5 | 1,9 | 78,79 |
| 12206-20 | 20 | 10,0 | 2,8 | 89,75 |



Saucepot

Casseruola alta
Fleischtopf
Brasière
Cacerola alta

| art. | Ø cm. | h. cm. | lt. | € |
|----------|-------|--------|-----|--------|
| 12207-24 | 24 | 14 | 5,9 | 122,41 |
| 12207-28 | 28 | 14 | 7,8 | 144,42 |



Sauté pan

Casseruola bassa
Stielkasserolle
Plat à sauter
Cazo recto bajo

| art. | Ø cm. | h. cm. | lt. | € |
|-----------|-------|--------|-----|--------|
| 12208-16 | 16 | 5,5 | 0,9 | 62,31 |
| 12208-20 | 20 | 7,0 | 1,8 | 80,30 |
| 12208-24 | 24 | 7,5 | 2,9 | 106,13 |
| 12208-28* | 28 | 7,5 | 4,0 | 124,12 |

With loop handle. – Con contromaniglia.



Frypan

Padella
Bratpfanne
Poêle à frire
Sartén

| art. | Ø cm. | h. cm. | lt. | € |
|-----------|-------|--------|-----|--------|
| 12214-20 | 20 | 4,0 | 0,9 | 61,61 |
| 12214-26 | 26 | 4,5 | 1,7 | 80,70 |
| 12214-30 | 30 | 5,0 | 2,4 | 95,78 |
| 12214-36* | 36 | 5,5 | 3,8 | 149,54 |

With loop handle. – Con contromaniglia.



Frypan non stick coated

Padella antiaderente
Bratpfanne Antihafbeschichtet
Poêle anti-adhérente
Sartén antiadherente

| art. | Ø cm. | h. cm. | lt. | € |
|-----------|-------|--------|-----|--------|
| 12217-20 | 20 | 4,0 | 0,9 | 71,05 |
| 12217-26 | 26 | 4,5 | 1,7 | 91,96 |
| 12217-30 | 30 | 5,0 | 2,4 | 109,95 |
| 12217-36* | 36 | 5,5 | 3,8 | 170,25 |

With loop handle. – Con contromaniglia.



Oval baker

Tegame ovale
Ovaler Bräter
Plat ovale
Sartén ovalada

| art. | dim. cm. | h. cm. | lt. | € |
|----------|----------|--------|-----|--------|
| 12238-30 | 30x18 | 5 | 1,4 | 107,94 |
| 12238-35 | 35x23 | 5 | 2,3 | 124,82 |



Lid

Coperchio
Deckel
Couvercle
Tapa

| art. | Ø cm. | € |
|----------|-------|-------|
| 12261-16 | 16 | 16,88 |
| 12261-18 | 18 | 18,49 |
| 12261-20 | 20 | 20,20 |
| 12261-24 | 24 | 24,12 |
| 12261-28 | 28 | 28,34 |



SERIES 15600 3-PLY

COPPER COOKWARE
PENTOLAME RAME



Flagship show cooking tool and also ideal for cooking and serving from the kitchen to the table. Body made of three metals, copper, aluminum and steel. Thickness 2,5 mm. A mix for a homogenous and sweet thermal spread that ensures cooking without attacking the foods, preserving its nutritional properties and organoleptic characteristics. Inside stainless steel, practical and easy to clean. Middle layer aluminum, lightweight and a very good heat conductor. Exterior glossy copper finishing, a tradition in the kitchen, fascinating and beautiful to see. Cast stainless steel handles assembled with strong section stainless steel rivets. Suitable for use on all cooking hobs including induction.

Strumento di punta per lo show cooking e anche l'ideale per cucinare e servire dalla cucina alla tavola. Corpo formato da tre metalli, rame, alluminio e acciaio. Spessore 2,5 mm. Un mix per un'omogenea e dolce diffusione termica che assicura una cottura senza aggredire i cibi, preservandone le proprietà nutrizionali e le caratteristiche organolettiche. Lamina interna in acciaio inox, pratico e facile da pulire. Strato intermedio in alluminio, leggero e ottimo conduttore di calore. Esterno in rame finitura lucida, una tradizione in cucina, affascinante e bello da vedere. Manici e maniglie in acciaio inox assemblati con rivetti inox di forte sezione. Adatto ad uso su tutti i fuochi inclusa l'induzione.



Saucepan

Casseruola alta
Stielkasserolle, hoch
Casserole haute
Cazo recto alto

| art. | Ø cm. | h. cm. | lt. | € |
|-----------|-------|--------|-----|--------|
| 15606-16 | 16 | 8 | 1,6 | 81,41 |
| 15606-20 | 20 | 11 | 3,5 | 125,83 |
| 15606-24* | 24 | 14 | 6,3 | 170,25 |
| 15606-28* | 28 | 16 | 9,8 | 211,75 |

With loop handle. – Con contromaniglia.



Casserole pot

Casseruola bassa
Stielkasserolle, niedrig
Sautoir
Cacerola baja

| art. | Ø cm. | h. cm. | lt. | € |
|-----------|-------|--------|-----|--------|
| 15608-20 | 20 | 7 | 2,2 | 105,63 |
| 15608-24 | 24 | 8 | 3,6 | 133,97 |
| 15608-28* | 28 | 9 | 5,5 | 165,32 |

With loop handle. – Con contromaniglia.



Frypan

Padella
Bratpfanne
Poêle à frire
Sartén

| art. | Ø cm. | h. cm. | lt. | € |
|-----------|-------|--------|-----|--------|
| 15614-20 | 20 | 4,0 | 1,2 | 80,00 |
| 15614-24 | 24 | 4,5 | 2,0 | 106,03 |
| 15614-28 | 28 | 5,0 | 3,0 | 131,15 |
| 15614-32* | 32 | 5,5 | 4,4 | 160,70 |

With loop handle. – Con contromaniglia.



Saucepot

Casseruola alta
Fleischtopf
Brasière
Cacerola alta

| art. | Ø cm. | h. cm. | lt. | € |
|----------|-------|--------|-----|--------|
| 15607-16 | 16 | 8 | 1,6 | 92,76 |
| 15607-20 | 20 | 11 | 3,5 | 131,96 |
| 15607-24 | 24 | 14 | 6,3 | 175,77 |
| 15607-28 | 28 | 16 | 9,8 | 216,88 |



Casserole pot

Casseruola bassa
Bratentopf
Sautoir
Cacerola baja

| art. | Ø cm. | h. cm. | lt. | € |
|----------|-------|--------|-----|--------|
| 15609-20 | 20 | 7 | 2,2 | 111,76 |
| 15609-24 | 24 | 8 | 3,6 | 139,49 |
| 15609-28 | 28 | 9 | 5,5 | 170,45 |



French omelet pan

Tegame
Bratpfanne
Poêle à paella
Paellera

| art. | Ø cm. | h. cm. | lt. | € |
|----------|-------|--------|-----|--------|
| 15615-20 | 20 | 4,5 | 1,4 | 90,95 |
| 15615-24 | 24 | 4,5 | 2,0 | 111,86 |
| 15615-28 | 28 | 5,5 | 3,4 | 135,78 |
| 15615-32 | 32 | 6,0 | 4,8 | 165,32 |



Lid

Coperchio
Deckel
Couvercle
Tapa

| art. | Ø cm. | € |
|----------|-------|-------|
| 15661-20 | 20 | 38,99 |
| 15661-24 | 24 | 49,65 |
| 15661-28 | 28 | 63,32 |



COPPER/RAME SERIES 15300-15400
COMPLEMENTARY ITEMS - COMPLEMETARI

Complementary items in solid copper, thickness from 1,5 to 2,5 mm. The interiors are tinned over the fire by hand. Handles in highly polished solid brass, assembled with wide rivets. Suitable for use on any heating element (except on induction hob).

Articoli complementari in rame massiccio, spessore da 1,5 a 2,5 mm. Interno stagnato a mano sulla fiamma. Manici e maniglie in ottone massiccio lucidato a specchio ed assemblati con rivetti di forte sezione. Adatto ad uso su tutti i fuochi (eccetto induzione).



Oval saucepan
Casseruola ovale
Ovaler Bratentopf
Casserole ovale
Cacerola oval

| art. | dim. cm. | h. cm. | € |
|----------|----------|--------|--------|
| 15338-38 | 38x25 | 13 | 691,24 |



Bake roasting pan
Tegame rettangolare
Rechteckige Pfanne
Plat à four
Rustidera

| art. | dim. cm. | h. cm. | € |
|----------|----------|--------|--------|
| 15343-36 | 38x28 | 11 | 675,76 |



Oval pan
Tegame ovale
Ovale Bratpfanne
Plat ovale à poignées
Bandeja oval

| art. | dim. cm. | h. cm. | € |
|----------|----------|--------|--------|
| 15339-36 | 38x26 | 11 | 638,98 |



Fish kettle
Pesciera
Fischkochkessel
Poissonnière
Hervidor pescado

| art. | dim. cm. | h. cm. | € |
|----------|----------|--------|--------|
| 15438-50 | 50x18 | 11 | 775,16 |



Bain-marie with porcelain
Bagnomaria con porcellana
Wasserbadkasserolle mit Porzellan
Bain-marie avec porcelaine
Baño maría con porcelana

| art. | Ø cm. | h. cm. | € |
|----------|-------|--------|--------|
| 15403-16 | 16 | 17 | 495,87 |



Fondue set with porcelain
Set fonduta con porcellana
Fondue-Service mit Porzellan
Service à fondue avec porcelaine
Servicio fondue con porcelana

| art. | Ø cm. | h. cm. | € |
|----------|-------|--------|--------|
| 15430-11 | 16 | 26 | 474,66 |



Sugar saucepan
Casseruola per zucchero
Zuckerpfännchen
Poelon à sucre
Cacerola para azúcar

| art. | Ø cm. | h. cm. | € |
|----------|-------|--------|--------|
| 15406-16 | 16 | 9 | 189,04 |
| 15406-20 | 20 | 10 | 247,23 |



Zabaione bowl
Casseruola per zabaione
Zabaionekasserolle
Poelon à zabaione
Cacerola sabayón

| art. | Ø cm. | € |
|----------|-------|--------|
| 15407-16 | 16 | 189,54 |
| 15407-20 | 20 | 247,23 |



Mixing bowl frosted finishing
Bastardella semisferica smerigliata
Schnees Schlagkessel mattiert
Bassine hémispherique givrée
Caldero esmerilado

| art. | Ø cm. | € |
|----------|-------|--------|
| 15409-26 | 26 | 153,16 |
| 15409-30 | 30 | 214,57 |
| 15409-36 | 36 | 298,59 |



Set 3 pcs bordelais mould
Set 3 stampi scanalati
Bordelais-Kuchenform 3 Stk
Set 3 moules à cannelés Bordelais
Juego 3 moldes para bordelais

| art. | Ø cm. | h. mm. | € |
|----------|-------|--------|-------|
| 15415-03 | 5,5 | 5 | 49,95 |





MINI COOKWARE MINIATURE

COOKWARE
PENTOLAME



Small pots ideal for side dishes and individual servings, soufflés, baked pasta, rice creams, raclette, savory as well as sweet pastries, desserts, etc., etc.. Versatile, functional, ready to be served from the kitchen to the table. Original and yet traditional, they come from the world of haute cuisine, ideal for enhancing creations or the simplest recipes, for the sake of conviviality, to give a more playful aspect to our meals.

Una gamma di miniature ideali per contorni e singole porzioni, soufflé, pasta al forno, creme di riso, raclette, brioche salate e dolci, dessert, ecc., ecc.. Polivalenti, funzionali, pronte per essere servite dalla cucina alla tavola. Originali eppure tradizionali, provengono dal mondo dell'alta gastronomia, strumento ideale per valorizzare creazioni estrose o le più semplici ricette, per amore della convivialità, per donare un aspetto più ludico ai nostri pasti.



Paderno Serie 15600 3-ply, inside stainless steel satin polished, intermediate layer in aluminum, outside copper mirror polished. Thickness 2 mm. Stainless steel cast handles, stainless steel rivets. Suitable for use on any heating element (except on induction hob).

Serie Paderno 15600 3-ply, lamina interna in acciaio inox finitura satinata, strato intermedio in alluminio, esterno rame lucido. Spessore 2 mm. Manicatura in acciaio inox, rivetti inox. Adatte ad uso su tutti i fuochi (eccetto induzione).



Saucepan

Casseruola
Stielkasserolle
Casserole
Cazo recto alto

| art. | Ø cm. | h. | lt. | U. Pack | € |
|----------|-------|-----|------|---------|-------|
| 15606-09 | 9 | 4,7 | 0,30 | 2 | 36,28 |
| 15606-10 | 10 | 6,5 | 0,50 | 2 | 40,70 |



Butter warmer

Scalda burro
Butterpfännchen
Casserole à beurre
Cacerola mantequilla

| art. | Ø cm. | h. | lt. | U. Pack | € |
|----------|-------|----|------|---------|-------|
| 15606-12 | 12 | 7 | 0,70 | 1 | 53,67 |



Saucepot

Casseruola
Fleischtopf
Brasière
Cacerola alta

| art. | Ø cm. | h. | lt. | U. Pack | € |
|----------|-------|-----|------|---------|-------|
| 15607-10 | 10 | 6,5 | 0,50 | 2 | 48,14 |



Ramekin

Ramekin
Ramekin
Ramekin
Ramekin

| art. | Ø cm. | h. | lt. | U. Pack | € |
|----------|-------|----|------|---------|-------|
| 15611-12 | 12 | 6 | 0,60 | 2 | 53,87 |



Frypan

Padella
Bratpfanne
Poêle
Sartén

| art. | Ø cm. | h. | lt. | U. Pack | € |
|----------|-------|-----|------|---------|-------|
| 15614-12 | 12 | 3,0 | 0,35 | 2 | 37,39 |



Omelet pan

Tegame
Servierpfanne
Poêle à paella
Paellera

| art. | Ø cm. | h. | lt. | U. Pack | € |
|----------|-------|-----|------|---------|-------|
| 15615-12 | 12 | 3,0 | 0,35 | 2 | 44,02 |



Gratin

Gratin
Gratin-Pfanne
Gratin
Gratin

| art. | Ø cm. | h. | lt. | U. Pack | € |
|----------|-------|-----|------|---------|-------|
| 15615-16 | 16 | 3,5 | 0,50 | 2 | 53,06 |



Oval baker

Tegame ovale
Oval-Pfanne
Casserole ovale
Sartén ovalada

| art. | cm. | h. | lt. | U. Pack | € |
|----------|-------|-----|------|---------|-------|
| 15638-17 | 17x13 | 3,5 | 0,48 | 2 | 74,27 |



Rectangular baker

Tegame rettangolare
Röster
Plat à four
Sartén rectangular

| art. | cm. | h. | U. Pack | € |
|----------|-------|----|---------|-------|
| 15643-12 | 12x10 | 4 | 2 | 56,88 |



Lid

Coperchio
Deckel
Couvercle
Tapa

| art. | Ø cm. | U. Pack | € |
|----------|-------|---------|-------|
| 15661-10 | 10 | 1 | 22,11 |
| 15661-12 | 12 | 1 | 26,33 |





Paderno Serie 12200 3-ply, inside stainless steel satin polished, intermediate layer in aluminum, outside stainless steel mirror polished. Thickness 2 mm. Stainless steel cast handles, stainless steel rivets. Suitable for use on any heating element.

Serie Paderno 12200 3-ply, lamina interna in acciaio inox finitura satinata, strato intermedio in alluminio, esterno inox lucido. Spessore 2 mm. Manicatura in acciaio inox, rivetti inox. Adatte ad uso su tutti i fuochi.



Saucepan

Casseruola
Stielkasserolle
Casserole
Cazo recto alto

| art. | Ø cm. | h. | lt. | U. Pack | € |
|----------|-------|-----|------|---------|-------|
| 12206-09 | 9 | 4,7 | 0,30 | 2 | 30,25 |
| 12206-10 | 10 | 6,5 | 0,50 | 2 | 32,26 |



Butter warmer

Scalda burro
Butterpfännchen
Casserole à beurre
Cacerola mantequilla

| art. | Ø cm. | h. | lt. | U. Pack | € |
|----------|-------|----|------|---------|-------|
| 12206-12 | 12 | 7 | 0,70 | 1 | 38,69 |



Saucepot

Casseruola
Fleischtopf
Brasière
Cacerola alta

| art. | Ø cm. | h. | lt. | U. Pack | € |
|----------|-------|-----|------|---------|-------|
| 12207-10 | 10 | 6,5 | 0,50 | 2 | 39,20 |



Ramekin

Ramekin
Ramekin
Ramekin
Ramekin

| art. | Ø cm. | h. | lt. | U. Pack | € |
|----------|-------|----|------|---------|-------|
| 12211-12 | 12 | 6 | 0,60 | 2 | 40,20 |



Frypan

Padella
Bratpfanne
Poêle
Sartén

| art. | Ø cm. | h. | lt. | U. Pack | € |
|----------|-------|-----|------|---------|-------|
| 12214-12 | 12 | 3,0 | 0,35 | 2 | 28,74 |



Omelet pan

Tegamino
Servierpfanne
Poêle à paella
Paellera

| art. | Ø cm. | h. | lt. | U. Pack | € |
|----------|-------|-----|------|---------|-------|
| 12215-12 | 12 | 3,0 | 0,35 | 2 | 35,68 |



Gratin

Gratin
Gratin-Pfanne
Gratin
Gratin

| art. | Ø cm. | h. | lt. | U. Pack | € |
|----------|-------|-----|------|---------|-------|
| 12215-16 | 16 | 3,5 | 0,50 | 2 | 40,70 |



Oval baker

Tegame ovale
Oval-Pfanne
Casserole ovale
Sartén ovalada

| art. | cm. | h. | lt. | U. Pack | € |
|----------|-------|-----|------|---------|-------|
| 12238-17 | 17x13 | 3,5 | 0,48 | 2 | 52,86 |



Rectangular baker

Tegame rettangolare
Röster
Plat à four
Sartén rectangular

| art. | cm. | h. | U. Pack | € |
|----------|-------|----|---------|-------|
| 12243-12 | 12x10 | 4 | 2 | 44,32 |



Lid

Coperchio
Deckel
Couvercle
Tapa

| art. | Ø cm. | U. Pack | € |
|----------|-------|---------|-------|
| 12261-10 | 10 | 1 | 18,09 |
| 12261-12 | 12 | 1 | 19,30 |





Aluminum body non-stick coated, brass handles. To add a touch of originality to any dish.

Corpo in alluminio con rivestimento antiaderente, manichatura in ottone. Per aggiungere un tocco di originalità a qualsiasi piatto.



Saucepan

Casseruola alta
Stielkasserole, hoch
Casserole haute
Cazo recto alto

| art. | Ø cm. | h. | lt. | € |
|----------|-------|----|------|-------|
| 16136-10 | 10 | 6 | 0,45 | 27,14 |



Sauté pan

Casseruola bassa
Stielkasserole, niedrig
Plat à sauter
Cazo recto bajo

| art. | Ø cm. | h. | lt. | € |
|----------|-------|----|-----|-------|
| 16138-10 | 10 | 4 | 0,3 | 27,14 |



Frypan

Padella
Bratpfanne
Poêle à frir
Sartén

| art. | Ø cm. | h. | lt. | € |
|----------|-------|----|-----|-------|
| 16134-12 | 12 | 4 | 0,4 | 28,04 |



Saucepan

Casseruola alta
Fleischtopf
Casserole haute
Cazo recto alto

| art. | Ø cm. | h. | lt. | € |
|----------|-------|----|------|-------|
| 16137-10 | 10 | 6 | 0,45 | 29,65 |



Casserole pot

Casseruola bassa
Bratentopf
Sautoir
Cacerola baja

| art. | Ø cm. | h. | lt. | € |
|----------|-------|----|-----|-------|
| 16139-10 | 10 | 4 | 0,3 | 28,44 |



French omelet pan

Tegamino
Servierpfanne
Poêle à paella
Paellera

| art. | Ø cm. | h. | lt. | € |
|----------|-------|----|-----|-------|
| 16135-12 | 12 | 4 | 0,4 | 28,44 |

ALUMINUM SERIES 16140
ALLUMINIO SERIE 16140



Ideal for serving from stovetop to table. Aluminum 99,5%. Thickness 3 mm. HP Dylan internal and external non-stick coating. Handle and rivets in stainless steel. Although the product can be washed in the dishwasher, we recommend hand washing to ensure beauty and performance over time.

Ideali per servire dal piano di cottura alla tavola. Alluminio 99,5%. Spessore 3 mm. Rivestimento antiaderente interno ed esterno HP Dylan. Manicatura e rivetti in acciaio inox. Anche se il prodotto può essere lavato in lavastoviglie, consigliamo di lavare a mano per conservare nel tempo bellezza e performance.



Mussel pot

Cocotte per molluschi
Muscheltopf
Casserole coquillage
Cacerola para mejillones

| art. | Ø cm. | h. | lt. | € |
|----------|-------|----|-----|-------|
| 16140-01 | 16 | 12 | 2,2 | 38,59 |



Sauce pot

Casseruola
Kasserolle
Brasière
Cacerola

| art. | Ø cm. | h. | lt. | € |
|----------|-------|-----|-----|-------|
| 16140-02 | 16 | 7,5 | 1,4 | 33,97 |



Frypan

Padella
Bratpfanne
Poêle
Sartén

| art. | Ø cm. | h. | lt. | € |
|----------|-------|----|-----|-------|
| 16140-03 | 16 | 4 | 0,6 | 26,63 |



Low sauce pot

Casseruola bassa
Flache Kasserolle
Faitout bas
Cacerola baja

| art. | Ø cm. | h. | lt. | € |
|----------|-------|-----|-----|-------|
| 16140-04 | 16 | 4,5 | 0,8 | 31,86 |



Wok pan

Wok
Wok-Pfanne
Poêle chinoise
Wok

| art. | Ø cm. | h. | lt. | € |
|----------|-------|----|-----|-------|
| 16140-05 | 16 | 6 | 0,9 | 29,35 |

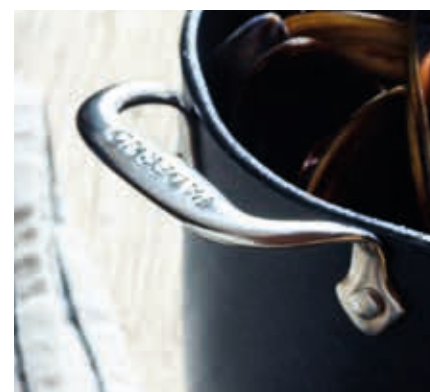

STONEWARE SERIES 41210



The stoneware gives a rustic and informal tone but can also create an atmosphere with an antique flavor in the most modern environments. Similar to porcelain, it can be used in the oven and in the microwave. Suitable for storing food in the freezer. Avoid thermal shocks. Stoneware retains heat very well and distributes it evenly. Perfect for serving from the oven to the table, keeping food warm during meals. Moreover the water absorption is equal to 0%, a feature that allows to keep the flavors of the food served unchanged. Easy to clean, dishwasher safe.

Lo stoneware regala un tono rustico ed informale, ma può anche creare un'atmosfera dal sapore antico negli ambienti più moderni. Simile alla porcellana, può essere utilizzato in forno e nel microonde. Adatto alla conservazione dei cibi nel congelatore. Evitare shock termici. I pezzi in stoneware trattengono molto bene il calore e lo distribuiscono in modo uniforme. Perfetto per servire dal forno alla tavola, mantenendo il cibo caldo durante i pasti. Facile da utilizzare e pulire, inoltre l'assorbimento di acqua è pari allo 0%, caratteristica che consente di mantenere invariati i sapori dei cibi serviti. Lavabile in lavastoviglie.



Oval saucepan
Casseruola ovale
Kasserolle oval
Casserole, ovale
Cacerola oval

| art. | cm. | h. | € |
|----------|--------|-----|------|
| 41210-03 | 13x8,2 | 3,9 | 6,33 |



Saucepan
Tegamimo
Pfännchen
Sautoir
Fuente huevo

| art. | Ø cm. | h. | € |
|----------|-------|----|-------|
| 41210-12 | 13 | 5 | 8,24 |
| 41210-13 | 15 | 5 | 11,36 |
| 41210-14 | 17 | 5 | 13,97 |



Rectangular saucepan
Casseruola rettangolare
Kasserolle rechteckig
Casserole, rectangulaire
Cacerola rectangular

| art. | cm. | h. | € |
|----------|--------|-----|------|
| 41210-05 | 13x8,2 | 3,9 | 6,73 |



Piepan
Tortiera
Kuchenform
Ramequin
Molde tarta

| art. | Ø cm. | h. | € |
|----------|-------|-----|------|
| 41210-10 | 11 | 3,9 | 6,03 |



Saucepan, round
Casseruola tonda
Kasserolle rund
Casserole, ronde
Cacerola redonda

| art. | Ø cm. | h. | € |
|----------|-------|-----|------|
| 41210-01 | 13 | 3,9 | 7,14 |



Saucepan with lid
Casseruola con coperchio
Kasserolle mit Deckel
Casserole avec couvercle
Cacerola con tapa

| art. | Ø cm. | h. | € |
|----------|-------|-----|-------|
| 41210-07 | 11,5 | 5,5 | 15,78 |
| 41210-08 | 13,0 | 7,5 | 17,99 |

ENAMELLED CAST IRON
GHISA SMALTATA



Manufactured in Turkey from cast iron and liquid enamel with high standards and advanced technology. Three layers of beautiful porcelain enamel fired twice for maximum beauty, durability and cooking performance. Beautiful design and individual serving size offers delightful presentation options for your entrées, appetizers or tempting desserts.

Prodotte in Turchia da ghisa e smalto liquido di elevati standard e tecnologia all'avanguardia. Tre strati di ottimo smalto porcellanato cotti due volte per il massimo in bellezza, durata e prestazioni al top. Un bel design e porzioni individuali offrono deliziose opzioni di presentazione per gustosi antipasti, contorni e dessert.



Saucepot round with lid

Casseruola tonda con coperchio
Fleischtopf, rund mit Deckel
Brasière avec couvercle
Cacerola redonda con tapa

| art. | Ø cm. | lt. | col. | € |
|----------|-------|------|------|-------|
| 44201R10 | 10 | 0,35 | ● | 46,43 |
| 44201V10 | 10 | 0,35 | ● | 46,43 |
| 44201B10 | 10 | 0,35 | ● | 46,43 |
| 44201O10 | 10 | 0,35 | ● | 46,43 |
| 44201N10 | 10 | 0,35 | ● | 46,43 |

Portion: – Porzioni: 1



Saucepot round with lid

Casseruola tonda con coperchio
Fleischtopf, rund mit Deckel
Brasière avec couvercle
Cacerola redonda con tapa

| art. | Ø cm. | lt. | col. | € |
|----------|-------|------|------|-------|
| 44201R12 | 12 | 0,55 | ● | 56,78 |
| 44201V12 | 12 | 0,55 | ● | 56,78 |
| 44201B12 | 12 | 0,55 | ● | 56,78 |
| 44201O12 | 12 | 0,55 | ● | 56,78 |
| 44201N12 | 12 | 0,55 | ● | 56,78 |

Portion: – Porzioni: 1



Oval saucepan with lid

Casseruola ovale con coperchio
Ovaler Bratentopf mit Deckel
Casserole ovale avec couvercle
Cacerola oval con tapa

| art. | cm. | col. | € |
|----------|--------|------|-------|
| 44202R12 | 12x9x6 | ● | 46,43 |
| 44202N12 | 12x9x6 | ● | 46,43 |

Portion: – Porzioni: 1



W

Saucepot stand

Supporto casseruolina
Fleischtopf-Träger
Support pour braisière
Soporte para cacerola

| art. | Ø cm. | € |
|----------|-------|-------|
| 44201-01 | 10 | 24,72 |



W

Saucepot stand

Supporto casseruolina
Fleischtopf-Träger
Support pour braisière
Soporte para cacerola

| art. | Ø cm. | € |
|----------|-------|-------|
| 44201-03 | 10 | 40,30 |



W

Saucepot platter

Sottopentola
Fleischtopfbrett
Planche à casserole
Tabla para cacerola

| art. | Ø cm. | € |
|----------|-------|-------|
| 44201-10 | 10-12 | 15,58 |



W

Saucepot platter

Sottopentola
Fleischtopfbrett
Planche à casserole
Tabla para cacerola

| art. | cm. | € |
|----------|------|-------|
| 44202-10 | 12x9 | 16,08 |



NEW

Mini wok

Mini wok
Mini-Wok
Mini wok
Mini wok

| art. | Ø cm. | h. | lt. | Por. | € |
|----------|-------|----|------|------|-------|
| 44270-16 | 16 | 8 | 0,75 | 1 | 53,87 |



Pan with wooden platter

Tegame con tagliere legno
Pfanne mit Holzbrett
Poêle avec plaque bois
Paellera con tabla madera

| art. | Ø cm. | lt. | Por. | € |
|----------|-------|------|------|-------|
| 44247S16 | 16 | 0,44 | 1-2 | 71,36 |

Beechwood. – Faggio.



Round pan

Padella tonda
Pfanne, rund
Poêle ronde
Sartén grill redonda

| art. | Ø cm. | Por. | € |
|----------|-------|------|-------|
| 44234-12 | 12 | 1 | 36,38 |
| 44234-16 | 16 | 1-2 | 46,73 |



Blinis pan, non-stick aluminum

Padella blini, alluminio antiaderente
Blinis-Pfännchen, Alu-Nichttafend
Poêle à blinis, alu anti-adhérente
Sartén blinis, aluminio antiadherente

| art. | Ø cm. | h. | € |
|----------|-------|----|-------|
| 16719-12 | 12 | 2 | 20,70 |



Blinis pan, steel

Padella blini, ferro
Blinis-Pfännchen, Eisen
Poêle à blinis, acier
Sartén blinis, hierro

| art. | Ø cm. | h. | € |
|----------|-------|----|-------|
| 11715-12 | 12 | 2 | 12,06 |



SERIES 1100

STAINLESS STEEL COOKWARE
PENTOLAME INOX



Outside and inside satin polished. Top edges mirror polished. Hollow tubular stay cool handles in stainless steel, ergonomically shaped. Extra thick edges. Double thick bottom. Sandwich thermoradiant bottom (stainless steel-aluminum-stainless steel). Concave bottom when cold and flat when hot (100% heat exploiting). Perfect for use on any type of stove, whether gas, electric, glass ceramic cooking surface or induction stove. All items have an induction suited sandwich bottom.

Finitura esterna ed interna satinata, bordo lucido. Manicatura tubolare in acciaio inox, anatomica, resistente al calore. Bordo rinforzato. Doppio spessore del fondo. Fondo termodiffusore sandwich (inox-alluminio-inox). Concavo a freddo e piano a caldo (sfruttamento del calore al 100%). Ideali per ogni tipo di cottura, gas, elettrica, vetroceramica e induzione. Tutti gli articoli sono dotati di speciale fondo termodiffusore adatto anche per piastre ad induzione.



Stock pot

Pentola
Hoher Suppentopf
Marmite traiteur
Olla recta

| art. | Ø cm. | h. | lt. | € |
|----------|-------|----|-------|--------|
| 11101-16 | 16 | 16 | 3,2 | 71,05 |
| 11101-20 | 20 | 20 | 6,2 | 94,27 |
| 11101-24 | 24 | 24 | 10,0 | 125,83 |
| 11101-28 | 28 | 28 | 16,5 | 167,73 |
| 11101-32 | 32 | 32 | 24,0 | 204,82 |
| 11101-36 | 36 | 36 | 36,0 | 294,77 |
| 11101-40 | 40 | 40 | 50,0 | 369,44 |
| 11101-45 | 45 | 45 | 70,0 | 483,00 |
| 11101-50 | 50 | 50 | 100,0 | 643,90 |



Low stock pot

Pentola bassa
Gemüsetopf
Faitout
Olla recta baja

| art. | Ø cm. | h. | lt. | € |
|----------|-------|----|------|---|
| 11105-20 | 20 | 17 | 5,0 | - |
| 11105-24 | 24 | 21 | 8,5 | - |
| 11105-28 | 28 | 23 | 14,5 | - |
| 11105-36 | 36 | 28 | 29,0 | - |



Saucepot

Casseruola alta
Fleischtopf
Brasière
Cacerola alta

| art. | Ø cm. | h. | lt. | € |
|----------|-------|------|------|--------|
| 11107-16 | 16 | 11,0 | 2,1 | 69,35 |
| 11107-20 | 20 | 13,0 | 4,0 | 83,92 |
| 11107-24 | 24 | 15,0 | 6,5 | 111,05 |
| 11107-28 | 28 | 17,5 | 10,8 | 140,90 |
| 11107-32 | 32 | 19,5 | 15,7 | 173,76 |
| 11107-36 | 36 | 21,5 | 22,0 | 220,20 |
| 11107-40 | 40 | 24,5 | 30,8 | 316,68 |
| 11107-45 | 45 | 27,5 | 44,0 | 418,98 |
| 11107-50 | 50 | 32,0 | 63,0 | 497,58 |



Casserole pot

Casseruola bassa
Bratentopf
Sautoir
Cacerola baja

| art. | Ø cm. | h. | lt. | € |
|----------|-------|------|------|--------|
| 11109-16 | 16 | 7,5 | 1,3 | 64,72 |
| 11109-20 | 20 | 8,0 | 2,5 | 79,09 |
| 11109-24 | 24 | 9,5 | 4,3 | 100,50 |
| 11109-28 | 28 | 11,0 | 6,7 | 124,72 |
| 11109-32 | 32 | 12,5 | 10,0 | 157,08 |
| 11109-36 | 36 | 14,0 | 14,2 | 190,85 |
| 11109-40 | 40 | 15,5 | 19,5 | 276,48 |
| 11109-45 | 45 | 17,0 | 27,0 | 356,98 |
| 11109-50 | 50 | 19,0 | 37,0 | 441,70 |



Colander for stock pot

Colapasta per pentola
Seiher für Suppentopf
Passoire pour marmite
Colador para olla recta

| art. | Ø cm. | h. | € |
|----------|-------|------|-------|
| 11123-20 | 20 | 22,0 | 93,47 |
| 11123-24 | 24 | 26,5 | - |
| 11123-28 | 28 | 29,5 | - |

Suitable for both item 11105 and 11101.
Per art. 11105 e art. 11101.



Stock pot with tap

Pentola con rubinetto
Hochtopf mit Hahn
Marmite avec robinet
Olla con grifo

| art. | Ø cm. | h. | lt. | € |
|----------|-------|----|-------|--------|
| 11102-28 | 28 | 28 | 16,5 | 399,59 |
| 11102-32 | 32 | 32 | 24,0 | 440,79 |
| 11102-36 | 36 | 36 | 36,0 | 510,54 |
| 11102-40 | 40 | 40 | 50,0 | 605,01 |
| 11102-45 | 45 | 45 | 70,0 | 728,22 |
| 11102-50 | 50 | 50 | 100,0 | 874,65 |



Steamer pot, perforated bottom

Inserto a vapore, fondo forato
Dampf-Siebeinsatz
Casserole à vapeur, perforée
Cacerola base perforada

| art. | Ø cm. | h. | € |
|----------|-------|------|-------|
| 11119-20 | 20 | 12,5 | 62,31 |
| 11119-28 | 28 | 17,0 | - |



Saucepan

Casseruola alta
Stielkasserolle, hoch
Casserole haute
Cazo recto alto

| art. | Ø cm. | h. | lt. | € |
|-----------|-------|------|------|--------|
| 11106-14 | 14 | 8,0 | 1,2 | 64,52 |
| 11106-16 | 16 | 11,0 | 2,1 | 71,76 |
| 11106-20 | 20 | 13,0 | 4,0 | 87,84 |
| 11106-24 | 24 | 15,0 | 6,5 | 112,76 |
| 11106-28* | 28 | 17,5 | 10,8 | 146,63 |
| 11106-32* | 32 | 19,5 | 15,7 | 187,23 |
| 11106-36* | 36 | 21,5 | 22,0 | 236,88 |

*With loop handle. – Con contromaniglia.



Sauté pan

Casseruola bassa
Stielkasserolle, niedrig
Plat à sauter
Cazo recto bajo

| art. | Ø cm. | h. | lt. | € |
|-----------|-------|------|------|--------|
| 11108-16 | 16 | 6,5 | 1,3 | 66,73 |
| 11108-20 | 20 | 8,0 | 2,5 | 81,91 |
| 11108-24 | 24 | 9,5 | 4,3 | 111,25 |
| 11108-28* | 28 | 11,0 | 6,7 | 138,79 |
| 11108-32* | 32 | 12,5 | 10,0 | 172,76 |
| 11108-36* | 36 | 14,0 | 14,2 | 214,67 |

*With loop handle. – Con contromaniglia.



NSF

Sauté pan

Casseruola conica
Sauteuse
Sauteuse
Cazo cónico

| art. | Ø cm. | h. | lt. | € |
|----------|-------|-----|-----|-------|
| 11112-16 | 16 | 6,0 | 1,0 | 61,31 |
| 11112-18 | 18 | 6,0 | 1,2 | 67,54 |
| 11112-20 | 20 | 6,5 | 1,6 | 73,47 |
| 11112-24 | 24 | 7,5 | 2,7 | 87,44 |



NSF

Curved sauté pan

Casseruola "bombé"
Sauteuse mit Schütterand
Sauteuse bombé
Cazo bombeado

| art. | Ø cm. | h. | lt. | € |
|----------|-------|-----|-----|--------|
| 11113-18 | 18 | 7,0 | 1,7 | 74,37 |
| 11113-20 | 20 | 7,5 | 2,2 | 83,42 |
| 11113-24 | 24 | 8,5 | 3,3 | 97,49 |
| 11113-26 | 26 | 9,0 | 4,2 | 111,86 |



NSF

Frypan

Padella
Bratpfanne
Poêle à frire
Sartén

| art. | Ø cm. | h. | € |
|-----------|-------|-----|--------|
| 11114-20 | 20 | 5,0 | 63,01 |
| 11114-24 | 24 | 5,0 | 79,09 |
| 11114-28 | 28 | 5,5 | 101,81 |
| 11114-32 | 32 | 6,0 | 122,11 |
| 11114-36* | 36 | 6,0 | 159,80 |
| 11114-40* | 40 | 6,0 | 200,80 |
| 11114-45* | 45 | 6,5 | 298,49 |

*With loop handle. – Con contromaniglia.



NSF

Frypan, non stick coating

Padella, antiaderente
Bratpfanne mit Antihafbeschichtung
Poêle avec revêtement anti-adhésif
Sartén antiaderente

| art. | Ø cm. | h. | € |
|----------|-------|-----|--------|
| 11117-20 | 20 | 5,0 | 94,57 |
| 11117-24 | 24 | 5,0 | 110,75 |
| 11117-28 | 28 | 5,5 | 133,97 |
| 11117-32 | 32 | 6,0 | 162,21 |
| 11117-36 | 36 | 6,0 | 208,94 |
| 11117-40 | 40 | 6,0 | 257,28 |



NSF

French omelet pan

Tegame
Servierpfanne
Poêle à paella
Paellera

| art. | Ø cm. | h. | € |
|----------|-------|-----|--------|
| 11115-20 | 20 | 5,0 | 52,36 |
| 11115-24 | 24 | 5,0 | 63,82 |
| 11115-28 | 28 | 5,5 | 86,33 |
| 11115-32 | 32 | 6,0 | 111,35 |
| 11115-36 | 36 | 6,0 | 145,73 |
| 11115-40 | 40 | 6,0 | 182,01 |
| 11115-45 | 45 | 6,5 | 277,78 |
| 11115-50 | 50 | 8,0 | 388,13 |



NSF

Cover, reinforced edge

Coperchio, bordo rinforzato
Deckel mit Randverstärkung
Couvercle, bord renforcé
Tapa, borde reforzado

| art. | Ø cm. | € |
|----------|-------|--------|
| 11161-12 | 12 | 12,46 |
| 11161-14 | 14 | 14,47 |
| 11161-16 | 16 | 16,68 |
| 11161-18 | 18 | 17,99 |
| 11161-20 | 20 | 19,10 |
| 11161-22 | 22 | 20,40 |
| 11161-24 | 24 | 22,01 |
| 11161-28 | 28 | 26,03 |
| 11161-32 | 32 | 33,97 |
| 11161-36 | 36 | 38,29 |
| 11161-40 | 40 | 45,33 |
| 11161-45 | 45 | 51,76 |
| 11161-50 | 50 | 63,11 |
| 11161-60 | 60 | 151,55 |



SERIES 2100

STAINLESS STEEL COOKWARE
PENTOLAME INOX



The serie 2100 has the same characteristics of the serie 1100. It varies only for the shape of the handles of 2 handles items. Perfect for use on any type of stove, whether gas, electric, glass ceramic cooking surface or induction stove. All items have an induction suited sandwich bottom.

La serie 2100 ha le stesse caratteristiche della serie 1100. Differisce solo per una diversa manicatura sugli articoli a 2 maniglie. Ideali per ogni tipo di cottura, gas, elettrica, vetroceramica e induzione. Tutti gli articoli sono dotati di speciale fondo termodiffusore adatto anche per piastre ad induzione.



Stock pot

Pentola
Hoher Suppentopf
Marmite traiteur
Olla recta

| art. | Ø cm. | h. | lt. | € |
|----------|-------|----|-------|--------|
| 12101-16 | 16 | 16 | 3,2 | 71,05 |
| 12101-20 | 20 | 20 | 6,2 | 94,27 |
| 12101-24 | 24 | 24 | 10,0 | 125,83 |
| 12101-28 | 28 | 28 | 16,5 | 167,73 |
| 12101-32 | 32 | 32 | 24,0 | 204,82 |
| 12101-36 | 36 | 36 | 36,0 | 294,77 |
| 12101-40 | 40 | 40 | 50,0 | 369,44 |
| 12101-45 | 45 | 45 | 70,0 | 483,00 |
| 12101-50 | 50 | 50 | 100,0 | 643,90 |



Saucepot

Casseruola alta
Fleischtopf
Brasière
Cacerola alta

| art. | Ø cm. | h. | lt. | € |
|----------|-------|------|------|--------|
| 12107-16 | 16 | 11,0 | 2,1 | 69,35 |
| 12107-20 | 20 | 13,0 | 4,0 | 83,92 |
| 12107-24 | 24 | 15,0 | 6,5 | 111,05 |
| 12107-28 | 28 | 17,5 | 10,8 | 140,90 |
| 12107-32 | 32 | 19,5 | 15,7 | 173,76 |
| 12107-36 | 36 | 21,5 | 22,0 | 220,20 |
| 12107-40 | 40 | 24,5 | 30,8 | 316,68 |
| 12107-45 | 45 | 27,5 | 44,0 | 418,98 |
| 12107-50 | 50 | 32,0 | 63,0 | 497,58 |



Casserole pot

Casseruola bassa
Bratentopf
Sautoir
Cacerola baja

| art. | Ø cm. | h. | lt. | € |
|----------|-------|------|------|--------|
| 12109-16 | 16 | 7,5 | 1,3 | 64,72 |
| 12109-20 | 20 | 8,0 | 2,5 | 79,09 |
| 12109-24 | 24 | 9,5 | 4,3 | 100,50 |
| 12109-28 | 28 | 11,0 | 6,7 | 124,72 |
| 12109-32 | 32 | 12,5 | 10,0 | 157,08 |
| 12109-36 | 36 | 14,0 | 14,2 | 190,85 |
| 12109-40 | 40 | 15,5 | 19,5 | 276,48 |
| 12109-45 | 45 | 17,0 | 27,0 | 356,98 |
| 12109-50 | 50 | 19,0 | 37,0 | 441,70 |



SERIES 1000

STAINLESS STEEL COOKWARE
PENTOLAME INOX



Outside and inside satin polished. Non-drip edge. Hollow tubular stay cool handles in stainless steel, ergonomically shaped. Uniform thickness in sides and bottoms. Sandwich thermoradiant bottom (stainless steel-aluminum-stainless steel). Concave bottom when cold and flat when hot (100% heat exploiting). Perfect for use on any type of stove, whether gas, electric, glass ceramic cooking surface or induction stove. All items have an induction suited sandwich bottom.

Finitura esterna ed interna satinata. Bordo a versare. Manicatura tubolare in acciaio inox, anatomica, resistente al calore. Parete e fondo a spessore uniforme. Fondo termodiffusore sandwich (inox-alluminio-inox). Concavo a freddo e piano a caldo (sfruttamento del calore al 100%). Ideali per ogni tipo di cottura, gas, elettrica, vetroceramica e induzione. Tutti gli articoli sono dotati di speciale fondo termodiffusore adatto anche per piastre ad induzione.



Stock pot

Pentola
Hoher Suppentopf
Marmite traiteur
Olla recta

| art. | Ø cm. | h. | lt. | € |
|----------|-------|------|-------|--------|
| 11001-16 | 16 | 16,0 | 3,2 | 45,63 |
| 11001-18 | 18 | 16,0 | 4,0 | 53,67 |
| 11001-20 | 20 | 18,0 | 5,5 | 56,68 |
| 11001-22 | 22 | 22,0 | 8,3 | 64,02 |
| 11001-24 | 24 | 24,0 | 10,5 | 67,44 |
| 11001-28 | 28 | 28,0 | 17,0 | 97,99 |
| 11001-32 | 32 | 27,5 | 20,4 | 119,39 |
| 11001-36 | 36 | 36,0 | 36,5 | 162,11 |
| 11001-40 | 40 | 40,0 | 50,0 | 204,32 |
| 11001-45 | 45 | 40,0 | 63,5 | 299,99 |
| 11001-50 | 50 | 50,0 | 98,0 | 458,68 |
| 11001-60 | 60 | 55,0 | 150,0 | 881,28 |



Saucepot

Casseruola alta
Fleischtopf
Brasière
Cacerola alta

| art. | Ø cm. | h. | lt. | € |
|----------|-------|------|------|--------|
| 11007-16 | 16 | 9,5 | 1,9 | 41,51 |
| 11007-18 | 18 | 10,8 | 2,7 | 44,82 |
| 11007-20 | 20 | 12,0 | 3,8 | 49,95 |
| 11007-22 | 22 | 13,0 | 5,0 | 55,17 |
| 11007-24 | 24 | 14,5 | 6,5 | 60,70 |
| 11007-28 | 28 | 16,0 | 9,8 | 81,41 |
| 11007-32 | 32 | 19,5 | 15,4 | 103,31 |
| 11007-36 | 36 | 21,5 | 20,5 | 128,34 |
| 11007-40 | 40 | 24,0 | 30,1 | 172,66 |
| 11007-45 | 45 | 27,0 | 42,9 | 255,37 |
| 11007-50 | 50 | 30,0 | 58,0 | 345,72 |
| 11007-60 | 60 | 35,0 | 99,0 | 687,92 |



Casserole pot

Casseruola bassa
Bratentopf
Sautoir
Cacerola baja

| art. | Ø cm. | h. | lt. | € |
|----------|-------|------|------|--------|
| 11009-16 | 16 | 6,5 | 1,3 | 38,79 |
| 11009-18 | 18 | 7,0 | 1,8 | 42,91 |
| 11009-20 | 20 | 7,5 | 2,5 | 47,13 |
| 11009-24 | 24 | 8,0 | 3,7 | 53,97 |
| 11009-28 | 28 | 9,5 | 5,8 | 73,67 |
| 11009-32 | 32 | 11,0 | 9,2 | 94,97 |
| 11009-36 | 36 | 13,0 | 13,0 | 119,39 |
| 11009-40 | 40 | 14,5 | 18,0 | 148,04 |
| 11009-45 | 45 | 15,5 | 24,6 | 221,20 |
| 11009-50 | 50 | 19,0 | 37,0 | 299,39 |
| 11009-60 | 60 | 25,0 | 70,7 | 563,91 |



Saucepan

Casseruola mezza alta
Bratentopf, mittelhoch
Casserole
Cacerola francés

| art. | Ø cm. | h. | lt. | € |
|----------|-------|----|-----|-------|
| 11010-16 | 16 | 8 | 1,6 | 41,51 |
| 11010-18 | 18 | 9 | 2,3 | 44,82 |
| 11010-20 | 20 | 10 | 3,1 | 50,05 |
| 11010-24 | 24 | 12 | 5,4 | 60,70 |



Sauté pan

Casseruola conica
Sauteuse
Sauteuse
Cazo cónico

| art. | Ø cm. | h. | lt. | € |
|----------|-------|-----|-----|-------|
| 11012-16 | 16 | 6,0 | 1,0 | 40,20 |
| 11012-18 | 18 | 6,0 | 1,2 | 44,62 |
| 11012-20 | 20 | 6,5 | 1,6 | 48,94 |
| 11012-24 | 24 | 7,5 | 2,7 | 58,59 |



Curved sauté pan

Casseruola bombé
Sauteuse mit Schütterand
Sauteuse bombé
Cazo bombeado

| art. | Ø cm. | h. | lt. | € |
|----------|-------|-----|-----|-------|
| 11013-18 | 18 | 7,0 | 1,7 | 46,43 |
| 11013-20 | 20 | 7,5 | 2,2 | 51,66 |
| 11013-24 | 24 | 8,5 | 3,3 | 61,61 |
| 11013-26 | 26 | 9,0 | 4,2 | 68,44 |





Saucepan

Casseruola alta
Stielkasserolle, hoch
Casserole haute
Cazo recto alto

| art. | Ø cm. | h. | lt. | € |
|-----------|-------|------|------|--------|
| 11006-12 | 12 | 7,0 | 0,8 | 27,64 |
| 11006-14 | 14 | 8,0 | 1,2 | 32,26 |
| 11006-16 | 16 | 9,5 | 1,9 | 36,98 |
| 11006-18 | 18 | 10,8 | 2,7 | 40,90 |
| 11006-20 | 20 | 12,0 | 3,8 | 43,92 |
| 11006-22 | 22 | 13,0 | 5,0 | 52,66 |
| 11006-24 | 24 | 14,5 | 6,5 | 57,89 |
| 11006-28* | 28 | 16,0 | 9,8 | 83,01 |
| 11006-32* | 32 | 19,5 | 15,4 | 109,65 |
| 11006-36* | 36 | 21,5 | 20,5 | 143,41 |

*With loop handle. – Con contromaniglia.



Saucepan

Casseruola mezza alta
Stielkasserolle, mittelhoch
Casserole
Cazo recto francés

| art. | Ø cm. | h. | lt. | € |
|----------|-------|----|-----|-------|
| 11011-16 | 16 | 8 | 1,6 | 35,38 |
| 11011-18 | 18 | 9 | 2,3 | 38,69 |
| 11011-20 | 20 | 10 | 3,1 | 41,91 |
| 11011-24 | 24 | 12 | 5,4 | 54,67 |



Sauté pan

Casseruola bassa
Stielkasserolle, niedrig
Plat à sauter
Cazo recto bajo

| art. | Ø cm. | h. | lt. | € |
|-----------|-------|------|------|--------|
| 11008-16 | 16 | 6,5 | 1,3 | 35,38 |
| 11008-18 | 18 | 7,0 | 1,8 | 39,09 |
| 11008-20 | 20 | 7,5 | 2,5 | 41,00 |
| 11008-24 | 24 | 8,0 | 3,7 | 50,75 |
| 11008-28* | 28 | 9,5 | 5,8 | 75,27 |
| 11008-32* | 32 | 11,0 | 9,2 | 101,00 |
| 11008-36* | 36 | 13,0 | 13,0 | 133,97 |

*With loop handle. – Con contromaniglia.



Frypan

Padella
Bratpfanne
Poêle à frire
Sartén

| art. | Ø cm. | h. | € |
|-----------|-------|-----|--------|
| 11014-20 | 20 | 5,0 | 38,39 |
| 11014-24 | 24 | 5,0 | 46,23 |
| 11014-28 | 28 | 5,5 | 62,21 |
| 11014-32 | 32 | 6,0 | 81,61 |
| 11014-36* | 36 | 6,0 | 107,03 |
| 11014-40* | 40 | 6,0 | 134,17 |
| 11114-45* | 45 | 6,5 | 298,49 |

*With loop handle. – Con contromaniglia.



Frypan, non stick

Padella, antiaderente
Bratpfanne, nichttaftend
Poêle, anti-adhérente
Sartén antiadherente

| art. | Ø cm. | h. | € |
|----------|-------|-----|--------|
| 11117-20 | 20 | 5,0 | 94,57 |
| 11117-24 | 24 | 5,0 | 110,75 |
| 11117-28 | 28 | 5,5 | 133,97 |
| 11117-32 | 32 | 6,0 | 162,21 |
| 11117-36 | 36 | 6,0 | 208,94 |
| 11117-40 | 40 | 6,0 | 257,28 |



French omelet pan

Tegame
Servierpfanne
Poêle à paella
Paellera

| art. | Ø cm. | h. | € |
|----------|-------|-----|--------|
| 11115-20 | 20 | 5,0 | 52,36 |
| 11115-24 | 24 | 5,0 | 63,82 |
| 11115-28 | 28 | 5,5 | 86,33 |
| 11115-32 | 32 | 6,0 | 111,35 |
| 11115-36 | 36 | 6,0 | 145,73 |
| 11115-40 | 40 | 6,0 | 182,01 |
| 11115-45 | 45 | 6,5 | 277,78 |
| 11115-50 | 50 | 8,0 | 388,13 |



Cover

Coperchio
Deckel
Couvercle
Tapa

| art. | Ø cm. | € |
|----------|-------|--------|
| 11061-12 | 12 | 8,24 |
| 11061-16 | 16 | 11,46 |
| 11061-18 | 18 | 12,26 |
| 11061-20 | 20 | 13,47 |
| 11061-22 | 22 | 13,97 |
| 11061-24 | 24 | 16,28 |
| 11061-28 | 28 | 19,20 |
| 11061-32 | 32 | 23,92 |
| 11061-36 | 36 | 28,14 |
| 11061-40 | 40 | 34,57 |
| 11061-45 | 45 | 40,00 |
| 11061-50 | 50 | 47,13 |
| 11161-60 | 60 | 151,55 |



SERIES 2000

STAINLESS STEEL COOKWARE
PENTOLAME INOX



The serie 2000 has the same characteristics of the serie 1000. It varies only for the shape of the handles of 2 handles items. Perfect for use on any type of stove, whether gas, electric, glass ceramic cooking surface or induction stove. All items have an induction suited sandwich bottom.

La serie 2000 ha le stesse caratteristiche della serie 1000. Differisce solo per una diversa manicatura sugli articoli a 2 maniglie. Ideali per ogni tipo di cottura, gas, elettrica, vetroceramica e induzione. Tutti gli articoli sono dotati di speciale fondo termodiffusore adatto anche per piastre ad induzione.



Stock pot
Pentola
Hoher Suppentopf
Marmite traiteur
Olla recta

| art. | Ø cm. | h. | lt. | € |
|----------|-------|------|-------|--------|
| 12001-16 | 16 | 16,0 | 3,2 | 45,43 |
| 12001-18 | 18 | 16,0 | 4,0 | 53,67 |
| 12001-20 | 20 | 18,0 | 5,5 | 56,68 |
| 12001-22 | 22 | 22,0 | 8,3 | 64,02 |
| 12001-24 | 24 | 24,0 | 10,5 | 67,44 |
| 12001-28 | 28 | 28,0 | 17,0 | 97,99 |
| 12001-32 | 32 | 27,5 | 20,4 | 119,39 |
| 12001-36 | 36 | 36,0 | 36,5 | 162,11 |
| 12001-40 | 40 | 40,0 | 50,0 | 204,32 |
| 12001-45 | 45 | 40,0 | 63,5 | 299,99 |
| 12001-50 | 50 | 50,0 | 98,0 | 458,68 |
| 12001-60 | 60 | 55,0 | 150,0 | 881,28 |



Saucepot
Casseruola alta
Fleischtopf
Brasière
Cacerola alta

| art. | Ø cm. | h. | lt. | € |
|----------|-------|------|------|--------|
| 12007-16 | 16 | 9,5 | 1,9 | 41,51 |
| 12007-18 | 18 | 10,8 | 2,7 | 44,82 |
| 12007-20 | 20 | 12,0 | 3,8 | 49,95 |
| 12007-22 | 22 | 13,0 | 5,0 | 55,17 |
| 12007-24 | 24 | 14,5 | 6,5 | 60,70 |
| 12007-28 | 28 | 16,0 | 9,8 | 81,41 |
| 12007-32 | 32 | 19,5 | 15,4 | 103,31 |
| 12007-36 | 36 | 21,5 | 20,5 | 128,34 |
| 12007-40 | 40 | 24,0 | 30,1 | 172,66 |
| 12007-45 | 45 | 27,0 | 42,9 | 255,37 |
| 12007-50 | 50 | 30,0 | 58,0 | 345,72 |
| 12007-60 | 60 | 35,0 | 99,0 | 687,92 |



Casserole pot
Casseruola bassa
Bratentopf
Sautoir
Cacerola baja

| art. | Ø cm. | h. | lt. | € |
|----------|-------|------|------|--------|
| 12009-16 | 16 | 6,5 | 1,3 | 38,79 |
| 12009-18 | 18 | 7,0 | 1,8 | 42,91 |
| 12009-20 | 20 | 7,5 | 2,5 | 47,13 |
| 12009-24 | 24 | 8,0 | 3,7 | 53,97 |
| 12009-28 | 28 | 9,5 | 5,8 | 73,67 |
| 12009-32 | 32 | 11,0 | 9,2 | 95,07 |
| 12009-36 | 36 | 13,0 | 13,0 | 119,39 |
| 12009-40 | 40 | 14,5 | 18,0 | 148,04 |
| 12009-45 | 45 | 15,5 | 24,6 | 221,20 |
| 12009-50 | 50 | 19,0 | 37,0 | 299,39 |
| 12009-60 | 60 | 25,0 | 70,7 | 563,91 |



Sauté pan
Casseruola conica
Sauteuse
Sauteuse
Cazo cónico

| art. | Ø cm. | h. | lt. | € |
|----------|-------|-----|-----|-------|
| 11012-16 | 16 | 6,0 | 1,0 | 40,20 |
| 11012-18 | 18 | 6,0 | 1,2 | 44,62 |
| 11012-20 | 20 | 6,5 | 1,6 | 48,94 |
| 11012-24 | 24 | 7,5 | 2,7 | 58,59 |



Curved sauté pan
Casseruola bombé
Sauteuse mit Schüttrand
Sauteuse bombé
Cazo bombeado

| art. | Ø cm. | h. | lt. | € |
|----------|-------|-----|-----|-------|
| 11013-18 | 18 | 7,0 | 1,7 | 46,43 |
| 11013-20 | 20 | 7,5 | 2,2 | 51,66 |
| 11013-24 | 24 | 8,5 | 3,3 | 61,61 |
| 11013-26 | 26 | 9,0 | 4,2 | 68,44 |



Saucepan
Casseruola mezza alta
Stielkasserolle, mittelhoch
Casserole
Cazo recto francés

| art. | Ø cm. | h. | lt. | € |
|----------|-------|------|-----|-------|
| 11011-16 | 16 | 8,0 | 1,6 | 35,38 |
| 11011-18 | 18 | 9,0 | 2,3 | 38,69 |
| 11011-20 | 20 | 10,0 | 3,1 | 41,91 |
| 11011-24 | 24 | 12,0 | 5,4 | 54,67 |





Asparagus-pot with lid

Pentola cuociasparagi con coperchio
Spargeltopf mit Deckel
Cuit-asperges avec couvercle
Olla espárragos con tapa

| art. | Ø cm. | h. | lt. | € |
|----------|-------|------|-----|-------|
| 12037-16 | 16 | 24,0 | 4,8 | 94,27 |



Saucepan

Casseruola alta
Stielkasserolle, hoch
Casserole haute
Cazo recto alto

| art. | Ø cm. | h. | lt. | € |
|-----------|-------|------|------|--------|
| 11006-12 | 12 | 7,0 | 0,8 | 27,64 |
| 11006-14 | 14 | 8,0 | 1,2 | 32,26 |
| 11006-16 | 16 | 9,5 | 1,9 | 36,98 |
| 11006-18 | 18 | 10,8 | 2,7 | 40,90 |
| 11006-20 | 20 | 12,0 | 3,8 | 43,92 |
| 11006-22 | 22 | 13,0 | 5,0 | 52,66 |
| 11006-24 | 24 | 14,5 | 6,5 | 57,89 |
| 11006-28* | 28 | 16,0 | 9,8 | 83,01 |
| 11006-32* | 32 | 19,5 | 15,4 | 109,65 |
| 11006-36* | 36 | 21,5 | 20,5 | 143,41 |

*With loop handle. – Con contromaniglia.



Sauté pan

Casseruola bassa
Stielkasserolle, niedrig
Plat à sauter
Cazo recto bajo

| art. | Ø cm. | h. | lt. | € |
|-----------|-------|------|------|--------|
| 11008-16 | 16 | 6,5 | 1,3 | 35,38 |
| 11008-18 | 18 | 7,0 | 1,8 | 39,09 |
| 11008-20 | 20 | 7,5 | 2,5 | 41,00 |
| 11008-24 | 24 | 8,0 | 3,7 | 50,75 |
| 11008-28* | 28 | 9,5 | 5,8 | 75,27 |
| 11008-32* | 32 | 11,0 | 9,2 | 101,00 |
| 11008-36* | 36 | 13,0 | 13,0 | 133,97 |

*With loop handle. – Con contromaniglia.



Frypan

Padella
Bratpfanne
Poêle à frire
Sartén

| art. | Ø cm. | h. | € |
|-----------|-------|-----|--------|
| 11014-20 | 20 | 5,0 | 38,39 |
| 11014-24 | 24 | 5,0 | 46,23 |
| 11014-28 | 28 | 5,5 | 62,21 |
| 11014-32 | 32 | 6,0 | 81,61 |
| 11014-36* | 36 | 6,0 | 107,03 |
| 11014-40* | 40 | 6,0 | 134,17 |
| 11114-45* | 45 | 6,5 | 298,49 |

*With loop handle. – Con contromaniglia.



Frypan, non stick

Padella, antiaderente
Bratpfanne, nichtaftend
Poêle, anti-adhérente
Sartén antiaderente

| art. | Ø cm. | h. | € |
|----------|-------|-----|--------|
| 11117-20 | 20 | 5,0 | 94,57 |
| 11117-24 | 24 | 5,0 | 110,75 |
| 11117-28 | 28 | 5,5 | 133,97 |
| 11117-32 | 32 | 6,0 | 162,21 |
| 11117-36 | 36 | 6,0 | 208,94 |
| 11117-40 | 40 | 6,0 | 257,28 |



French omelet pan

Tegame
Servierpfanne
Poêle à paella
Paellera

| art. | Ø cm. | h. | € |
|----------|-------|-----|--------|
| 11115-20 | 20 | 5,0 | 52,36 |
| 11115-24 | 24 | 5,0 | 63,82 |
| 11115-28 | 28 | 5,5 | 86,33 |
| 11115-32 | 32 | 6,0 | 111,35 |
| 11115-36 | 36 | 6,0 | 145,73 |
| 11115-40 | 40 | 6,0 | 182,01 |
| 11115-45 | 45 | 6,5 | 277,78 |
| 11115-50 | 50 | 8,0 | 388,13 |



Cover

Coperchio
Deckel
Couvercle
Tapa

| art. | Ø cm. | € |
|----------|-------|--------|
| 11061-16 | 16 | 11,46 |
| 11061-18 | 18 | 12,26 |
| 11061-20 | 20 | 13,47 |
| 11061-22 | 22 | 13,97 |
| 11061-24 | 24 | 16,28 |
| 11061-28 | 28 | 19,20 |
| 11061-32 | 32 | 23,92 |
| 11061-36 | 36 | 28,14 |
| 11061-40 | 40 | 34,57 |
| 11061-45 | 45 | 40,00 |
| 11061-50 | 50 | 47,13 |
| 11161-60 | 60 | 151,55 |



FOR **GLUTEN-FREE** COOKING



AL SERVIZIO DELLA CUCINA SENZA GLUTINE

FOR PRODUCT # LIST SEE PAGES AFTER SECTION "ELECTRIC APPLIANCES"
PER L'ELENCO PRODOTTI VEDI PAGINE DOPO LA SEZIONE "APPARECCHI ELETTRICI"



Consistently with the functional approach, which has always marked the brand, Paderno offers a complete product line and professional tools, easily recognizable in the kitchen, which can reduce possible mistakes during their use to protect people affected by celiac disease. Developed and realized in 2013 in collaboration with Associazione Italiana Celiachia Lombardia ONLUS (Italian Society for the Celiac Disease – Lombardy Section), this project makes Sambonet Paderno Industrie S.p.A. the first company in its market that offers to the HoReCa channel a complete line of items intended for gluten-free cooking.

Some distinguished special features, such as golden PVD handles for pans and pots and a special customised logo for utensils, will allow professionals to easily identify all these items in the kitchen.

This product line aims at:

- Reducing the risk of accidental food cross-contamination;
- Making it easier for professionals to work and provide services to clients with food intolerances;
- Raising awareness on the gluten-free diet issue in the industry so as to respond to the new needs of consumers.

Coerentemente all'ottica di servizio che contraddistingue da sempre il marchio, Paderno propone una linea completa di articoli e strumenti professionali facilmente identificabili in cucina, in grado di abbattere eventuali errori durante il loro utilizzo a salvaguardia del cliente celiaco e di tutti gli intolleranti. Sviluppato e concretizzato nel 2013 in collaborazione con l'Associazione Italiana Celiachia Lombardia ONLUS, questo progetto colloca Sambonet Paderno Industrie come prima azienda del settore a offrire al canale Ho.Re.Ca una linea completa di articoli da destinare alla preparazione di pietanze senza glutine.

Attraverso alcuni elementi distintivi e differenzianti, come manici in PVD oro per pentole e padelle e personalizzazione con un logo specifico per utensili, tutti gli strumenti saranno facilmente identificabili in cucina.

Questa gamma contribuisce a:

- Diminuire il rischio di accidentali contaminazioni crociate degli alimenti;
- Facilitare il professionista nell'operare e nell'offrire un servizio a favore del cliente con intolleranze alimentari;
- Sensibilizzare il settore sul tema "gluten free" di fronte alle nuove esigenze dei consumatori.

SERIES 2500 3-PLY

STAINLESS STEEL COOKWARE
PENTOLAME INOX

**INDUCTION
READY!**



Paderno serie 2500 3-ply is especially designed for professional kitchens, features super heat-conductive multi-layer construction that distributes heat from bottom to rim quickly and evenly. Outside and inside satin polished. Non-drip edge. Stainless steel handles, ergonomically shaped. Uniform thickness in sides and bottoms. Energy saving on all types of cookers. Suitable for use on all cooking hobs including induction.

La serie Paderno 2500 3-ply concepita per l'utilizzo nelle cucine professionali è costruita in materiale multistrato che assicura una distribuzione rapida ed uniforme del calore su tutta la superficie dell'utensile. Finitura esterna ed interna satinata. Bordo a versare. Manicatura anatomica in acciaio inox. Parete e fondo a spessore uniforme. Risparmio di energia. Adatta per l'uso su tutti i piani cottura compresa l'induzione.



Saucepot

Casseruola alta
Fleischtopf
Brazière
Cacerola alta

| art. | Ø cm. | h. cm. | lt. | € |
|----------|-------|--------|-----|-------|
| 12507-24 | 24 | 11,5 | 5,0 | 63,01 |
| 12507-28 | 28 | 14,0 | 8,5 | 81,41 |



Casserole pot

Casseruola bassa
Bratentopf
Sautoir
Cacerola baja

| art. | Ø cm. | h. cm. | lt. | € |
|----------|-------|--------|-----|-------|
| 12509-20 | 20 | 9,5 | 2,8 | 44,82 |
| 12509-24 | 24 | 10,5 | 4,7 | 60,30 |
| 12509-28 | 28 | 11,0 | 6,5 | 74,27 |



Saucepan

Casseruola mezza alta
Stielkasserolle, mittelhoch
Casserole
Cazo recto francés

| art. | Ø cm. | h. cm. | lt. | € |
|----------|-------|--------|-----|-------|
| 12511-16 | 16 | 7,5 | 1,5 | 37,29 |
| 12511-18 | 18 | 8,0 | 2,0 | 40,40 |
| 12511-20 | 20 | 8,8 | 2,5 | 46,63 |
| 12511-24 | 24 | 10,5 | 4,6 | 63,72 |



Sauté pan

Casseruola bassa
Stielkasserolle, niedrig
Plat à sauter
Cazo recto bajo

| art. | Ø cm. | h. cm. | lt. | € |
|----------|-------|--------|-----|-------|
| 12508-24 | 24 | 5,0 | 2,0 | 51,36 |



Wok with grid and cover

Wok c/griglia e coperchio
Wok mit Rost und Deckel
Wok avec grille et couvercle
Wok con rejilla y tapa

| art. | Ø cm. | h. cm. | € |
|----------|-------|--------|--------|
| 12529-32 | 32 | 8 | 118,39 |



Curved sauté pan

Casseruola bombé
Sauteuse mit Schüttrand
Sauteuse bombé
Cazo bombeado

| art. | Ø cm. | h. cm. | lt. | € |
|----------|-------|--------|-----|-------|
| 12513-16 | 16 | 6,0 | 1,2 | 34,77 |
| 12513-18 | 18 | 6,5 | 1,6 | 38,79 |
| 12513-20 | 20 | 7,0 | 2,0 | - |
| 12513-24 | 24 | 8,5 | 3,8 | 56,78 |



Frypan

Padella
Bratpfanne
Poêle à frire
Sartén

| art. | Ø cm. | h. cm. | € |
|----------|-------|--------|-------|
| 12514-24 | 24 | 5,5 | 33,06 |
| 12514-26 | 26 | 5,5 | 51,36 |
| 12514-28 | 28 | 5,5 | 40,10 |
| 12514-32 | 32 | 4,0 | 54,37 |
| 12514-36 | 36 | 4,0 | 61,10 |



Frypan, non stick coating

Padella, antiaderente
Bratpfanne mit Antihafbeschichtung
Poêle avec revêtement anti-adhésif
Sartén antiadherente

| art. | Ø cm. | h. cm. | € |
|----------|-------|--------|-------|
| 12517-24 | 24 | 5,5 | 42,71 |
| 12517-26 | 26 | 5,5 | 66,33 |
| 12517-28 | 28 | 5,5 | 53,97 |
| 12517-32 | 32 | 5,5 | 69,65 |
| 12517-36 | 36 | 5,5 | 79,50 |



Lid

Coperchio
Deckel
Couvercle
Tapa

| art. | Ø cm. | € |
|----------|-------|-------|
| 12561-16 | 16 | 14,17 |
| 12561-18 | 18 | 15,58 |
| 12561-20 | 20 | 16,98 |
| 12561-24 | 24 | 21,31 |
| 12561-26 | 26 | 23,82 |
| 12561-28 | 28 | 26,63 |



SERIES 12300 3-PLY

STAINLESS STEEL COOKWARE
PENTOLAME INOX



Paderno serie 2300 3-ply is especially designed for front cooking and live cooking stations. Features super heat-conductive multi-layer construction that distributes heat from bottom to rim quickly and evenly. An attractive, multifunctional and colored line available in white, yellow, green, blue and orange. External finish with special heat-resistant paint (Whitford technology). Ideal for all types of cooking including induction. The lid equipped with a steam release device can be hooked to the side of the pan.

La serie Paderno 2300 3-ply è concepita per il "front cooking" e per le "live cooking stations". Costruita in materiale multistrato, assicura una distribuzione rapida ed uniforme del calore su tutta la superficie dell'utensile. Una linea attrattiva, multifunzionale e colorata disponibile nelle varianti bianco, giallo, verde, blu e arancio. Finitura esterna con speciale vernice (tecnologia Whitford) resistente al calore. Ideale per ogni tipo di cottura inclusa l'induzione. Il coperchio dotato di dispositivo di rilascio del vapore, può essere agganciato a lato della casseruola.



Stew pan with lid

Casseruola con coperchio
 Brattpf mit Deckel
 Sautoir avec couvercle
 Sartén con tapa

| art. | Ø cm. | h. cm. | lt. | € |
|----------|-------|--------|-----|--------|
| 12303W16 | 16 | 8 | 1,6 | 95,07 |
| 12303W20 | 20 | 10 | 3,1 | 118,59 |
| 12303W24 | 24 | 12 | 5,4 | 148,94 |



Stew pan with lid

Casseruola con coperchio
 Brattpf mit Deckel
 Sautoir avec couvercle
 Sartén con tapa

| art. | Ø cm. | h. cm. | lt. | € |
|----------|-------|--------|-----|--------|
| 12303Y16 | 16 | 8 | 1,6 | 95,07 |
| 12303Y20 | 20 | 10 | 3,1 | 118,59 |
| 12303Y24 | 24 | 12 | 5,4 | 148,94 |



Stew pan with lid

Casseruola con coperchio
 Brattpf mit Deckel
 Sautoir avec couvercle
 Sartén con tapa

| art. | Ø cm. | h. cm. | lt. | € |
|----------|-------|--------|-----|--------|
| 12303G16 | 16 | 8 | 1,6 | 95,07 |
| 12303G20 | 20 | 10 | 3,1 | 118,59 |
| 12303G24 | 24 | 12 | 5,4 | 148,94 |



Stew pan with lid

Casseruola con coperchio
 Brattpf mit Deckel
 Sautoir avec couvercle
 Sartén con tapa

| art. | Ø cm. | h. cm. | lt. | € |
|----------|-------|--------|-----|--------|
| 12303B16 | 16 | 8 | 1,6 | 95,07 |
| 12303B20 | 20 | 10 | 3,1 | 118,59 |
| 12303B24 | 24 | 12 | 5,4 | 148,94 |



Stew pan with lid

Casseruola con coperchio
 Brattpf mit Deckel
 Sautoir avec couvercle
 Sartén con tapa

| art. | Ø cm. | h. cm. | lt. | € |
|----------|-------|--------|-----|--------|
| 12303O16 | 16 | 8 | 1,6 | 95,07 |
| 12303O20 | 20 | 10 | 3,1 | 118,59 |
| 12303O24 | 24 | 12 | 5,4 | 148,94 |



Roasting pan with lid

Casseruola carrè con coperchio
 Bräter mit Deckel
 Rôtissoire avec couvercle
 Asadera con tapa

| art. | cm. | h. cm. | lt. | € |
|----------|-------|--------|-----|--------|
| 12304W26 | 27x27 | 7 | 4 | 176,68 |



Roasting pan with lid

Casseruola carrè con coperchio
 Bräter mit Deckel
 Rôtissoire avec couvercle
 Asadera con tapa

| art. | cm. | h. cm. | lt. | € |
|----------|-------|--------|-----|--------|
| 12304Y26 | 27x27 | 7 | 4 | 176,68 |



Roasting pan with lid

Casseruola carrè con coperchio
 Bräter mit Deckel
 Rôtissoire avec couvercle
 Asadera con tapa

| art. | cm. | h. cm. | lt. | € |
|----------|-------|--------|-----|--------|
| 12304G26 | 27x27 | 7 | 4 | 176,68 |



Roasting pan with lid

Casseruola carrè con coperchio
 Bräter mit Deckel
 Rôtissoire avec couvercle
 Asadera con tapa

| art. | cm. | h. cm. | lt. | € |
|----------|-------|--------|-----|--------|
| 12304B26 | 27x27 | 7 | 4 | 176,68 |



Roasting pan with lid

Casseruola carrè con coperchio
 Bräter mit Deckel
 Rôtissoire avec couvercle
 Asadera con tapa

| art. | cm. | h. cm. | lt. | € |
|----------|-------|--------|-----|--------|
| 12304O26 | 27x27 | 7 | 4 | 176,68 |





Induction station
Stazione induzione
Induktionsstation
Station d'induction
Estación inducción

| art. | Ø cm. | cm. | h. cm. | scala | range | € |
|----------|-------|-----------|--------|---------|-------|--------|
| 49999-04 | 24 | 35,4x32,5 | 19 | 220-240 | 900 | 354,36 |

Induction plate with temperature regulator 60>140°C. Black metal support, walnut wood insert and stainless steel frame. – Piastra a induzione con regolatore di temperatura 60>140°C. Supporto in metallo nero, inserto in legno di noce e cornice inox.



Bowl double wall
Ciotola doppia parete
Schüssel, doppelwandig
Bol à double paroi
Tazón doble pared

| art. | Ø cm. | h. cm. | € |
|----------|-------|--------|-------|
| 12300-18 | 18 | 14,0 | 39,30 |
| 12300-24 | 24 | 18,2 | 57,79 |



Bowl double wall
Ciotola doppia parete
Schüssel, doppelwandig
Bol à double paroi
Tazón doble pared

| art. | Ø cm. | h. cm. | € |
|----------|-------|--------|-------|
| 12300W18 | 18 | 14,0 | 52,36 |
| 12300W24 | 24 | 18,2 | 78,79 |



Bowl double wall
Ciotola doppia parete
Schüssel, doppelwandig
Bol à double paroi
Tazón doble pared

| art. | Ø cm. | h. cm. | € |
|----------|-------|--------|-------|
| 12300Y18 | 18 | 14,0 | 52,36 |
| 12300Y24 | 24 | 18,2 | 78,79 |



Bowl double wall
Ciotola doppia parete
Schüssel, doppelwandig
Bol à double paroi
Tazón doble pared

| art. | Ø cm. | h. cm. | € |
|----------|-------|--------|-------|
| 12300G18 | 18 | 14,0 | 52,36 |
| 12300G24 | 24 | 18,2 | 78,79 |



Bowl double wall
Ciotola doppia parete
Schüssel, doppelwandig
Bol à double paroi
Tazón doble pared

| art. | Ø cm. | h. cm. | € |
|----------|-------|--------|-------|
| 12300B18 | 18 | 14,0 | 52,36 |
| 12300B24 | 24 | 18,2 | 78,79 |



Bowl double wall
Ciotola doppia parete
Schüssel, doppelwandig
Bol à double paroi
Tazón doble pared

| art. | Ø cm. | h. cm. | € |
|----------|-------|--------|-------|
| 12300O18 | 18 | 14,0 | 52,36 |
| 12300O24 | 24 | 18,2 | 78,79 |





SERIES 6100

ALUMINUM COOKWARE
PENTOLAME ALLUMINIO



Made in heavy duty aluminum.
Hollow tubular handles in stainless steel 18/10, stay cool.
Rounded corners provide easy cleanup.
Thickness from mm 2 to mm 5,5.

Esecuzione in alluminio pesante.
Manicatura tubolare in acciaio inossidabile 18/10, resistente al calore.
Ampio raggio di raccordo fondo-parete, igienico e facile da pulire.
Spessore da mm 2 a mm 5,5.



Stock pot

Pentola
Hoher Suppentopf
Marmite traiteur
Olla recta

| art. | Ø cm. | h. cm. | lt. | € |
|----------|-------|--------|-------|--------|
| 16101-16 | 16 | 16,0 | 3,2 | 52,56 |
| 16101-20 | 20 | 20,0 | 6,2 | 58,09 |
| 16101-24 | 24 | 24,0 | 10,0 | 68,04 |
| 16101-28 | 28 | 28,0 | 16,5 | 92,96 |
| 16101-32 | 32 | 29,5 | 22,0 | 120,50 |
| 16101-36 | 36 | 36,0 | 36,0 | 147,94 |
| 16101-40 | 40 | 40,0 | 50,0 | 180,50 |
| 16101-45 | 45 | 45,0 | 70,0 | 205,52 |
| 16101-50 | 50 | 50,0 | 100,0 | 236,48 |



Saucepot

Casseruola alta
Fleischtopf
Braising
Cacerola alta

| art. | Ø cm. | h. cm. | lt. | € |
|----------|-------|--------|------|--------|
| 16107-16 | 16 | 11,0 | 2,1 | 39,60 |
| 16107-20 | 20 | 13,0 | 4,0 | 43,82 |
| 16107-28 | 28 | 17,5 | 10,8 | - |
| 16107-32 | 32 | 19,5 | 15,7 | 93,36 |
| 16107-36 | 36 | 21,0 | 21,5 | 108,84 |
| 16107-40 | 40 | 24,0 | 30,0 | 133,97 |
| 16107-45 | 45 | 27,0 | 43,0 | 158,09 |
| 16107-50 | 50 | 30,0 | 59,0 | 191,55 |



Casserole pot

Casseruola bassa
Bratentopf
Sautoir
Cacerola baja

| art. | Ø cm. | h. cm. | lt. | € |
|----------|-------|--------|------|--------|
| 16109-24 | 24 | 9,5 | 4,3 | 46,33 |
| 16109-28 | 28 | 11,0 | 6,7 | - |
| 16109-32 | 32 | 12,5 | 10,0 | - |
| 16109-36 | 36 | 14,0 | 14,0 | 94,17 |
| 16109-40 | 40 | 16,0 | 20,0 | - |
| 16109-45 | 45 | 18,0 | 28,5 | 130,95 |
| 16109-50 | 50 | 19,0 | 37,0 | 162,41 |



Saucepot

Casseruola
Gemüsetopf
Braising
Cacerola

| art. | Ø cm. | h. cm. | lt. | € |
|----------|-------|--------|------|-------|
| 16929-36 | 36 | 17 | 17,0 | 72,36 |
| 16929-40 | 40 | 18 | 22,5 | 87,23 |



Oval saucepan with cover

Casseruola ovale con coperchio
Ovale Kasserolle mit Deckel
Casserole ovale avec couvercle
Cacerola oval con tapa

| art. | Ø cm. | h. cm. | lt. | € |
|----------|-------|--------|-----|--------|
| 16938-36 | 36 | 14,5 | 10 | 113,87 |
| 16938-40 | 40 | 16,0 | 14 | 128,04 |
| 16938-45 | 45 | 17,0 | 19 | 155,47 |



Saucepan

Casseruola alta
Stielkasserolle, hoch
Casserole haute
Cazo recto alto

| art. | Ø cm. | h. cm. | lt. | € |
|----------|-------|--------|------|-------|
| 16106-16 | 16 | 11,0 | 2,1 | 38,99 |
| 16106-20 | 20 | 13,0 | 4,0 | 43,72 |
| 16106-24 | 24 | 15,0 | 6,5 | - |
| 16106-28 | 28 | 17,5 | 10,8 | 64,72 |



Casserole pot

Casseruola bassa
Stielkasserolle, niedrig
Sautoir
Cacerola baja

| art. | Ø cm. | h. cm. | lt. | € |
|----------|-------|--------|-----|---|
| 16108-24 | 24 | 9,5 | 4,3 | - |
| 16108-28 | 28 | 11,0 | 6,7 | - |



Frypan

Padella
Bratpfanne
Poêle à frir
Sartén

| art. | Ø cm. | h. cm. | € |
|----------|-------|--------|-------|
| 16114-20 | 20 | 4,0 | 25,33 |
| 16114-24 | 24 | 5,0 | 30,65 |
| 16114-28 | 28 | 5,0 | 38,29 |
| 16114-32 | 32 | 5,3 | 45,43 |
| 16114-36 | 36 | 6,0 | 55,17 |
| 16114-40 | 40 | 7,0 | 66,03 |



French omelet pan

Tegame
Servierpfanne
Poêle à paella
Paellera

| art. | Ø cm. | h. cm. | € |
|----------|-------|--------|-------|
| 16115-36 | 36 | 7,0 | 61,61 |
| 16115-40 | 40 | 7,5 | - |
| 16115-45 | 45 | 7,5 | 90,35 |



Lid
Coperchio
Deckel
Couvercle
Tapa

| art. | Ø cm. | € |
|----------|-------|--------|
| 16961-16 | 16 | 10,45 |
| 16961-20 | 20 | 10,85 |
| 16961-24 | 24 | 11,76 |
| 16961-28 | 28 | 17,79 |
| 16961-32 | 32 | 20,80 |
| 16961-36 | 36 | 24,02 |
| 16961-40 | 40 | 31,26 |
| 16961-45 | 45 | 35,38 |
| 16961-50 | 50 | 43,62 |
| 16961-60 | 60 | 102,61 |



Casserole pot, non stick
Casseruola alta, antiaderente
Fleischtopf, nichttaftend
Brasière, anti-adhérente
Cacerola alta, antiadherente

| art. | Ø cm. | h. cm. | lt. | € |
|----------|-------|--------|------|--------|
| 16127-16 | 16 | 11,0 | 2,1 | 62,61 |
| 16127-20 | 20 | 13,0 | 4,0 | 78,29 |
| 16127-32 | 32 | 19,5 | 15,7 | 164,82 |
| 16127-36 | 36 | 21,0 | 21,5 | 197,08 |
| 16127-40 | 40 | 24,0 | 30,0 | 247,63 |



Casserole pot, non stick
Casseruola bassa, antiaderente
Bratentopf, nichttaftend
Sautoir, anti-adhérente
Cacerola baja, antiadherente

| art. | Ø cm. | h. cm. | lt. | € |
|----------|-------|--------|------|--------|
| 16120-24 | 24 | 9,5 | 4,3 | 73,47 |
| 16120-28 | 28 | 11,0 | 6,7 | 88,74 |
| 16120-32 | 32 | 12,5 | 10,0 | 112,16 |
| 16120-36 | 36 | 14,0 | 14,0 | 147,74 |
| 16120-40 | 40 | 16,0 | 20,0 | 207,13 |





French omelet pan, non stick
Tegame, antiaderente
Servierpfanne, nichttaftend
Poêle à paella, anti-adhérente
Paellera antiaderente

| art. | Ø cm. | h. cm. | € |
|----------|-------|--------|-------|
| 16116-28 | 28 | 6,5 | - |
| 16116-32 | 32 | 6,5 | 80,60 |
| 16116-36 | 36 | 7,0 | 95,68 |
| 16116-40 | 40 | 7,5 | - |



Frypan, non stick
Padella, antiaderente
Bratpfanne, nichttaftend
Poêle, anti-adhérente
Sartén antiaderente

| art. | Ø cm. | h. cm. | € |
|----------|-------|--------|-------|
| 41720-18 | 18 | 3,8 | 14,67 |
| 41720-20 | 20 | 3,8 | 16,78 |
| 41720-24 | 24 | 4,5 | 20,60 |
| 41720-28 | 28 | 5,4 | 24,42 |
| 41720-30 | 30 | 5,4 | 27,34 |
| 41720-32 | 32 | 5,6 | 28,54 |



Frypan, non stick
Padella, antiaderente
Bratpfanne, nichttaftend
Poêle, anti-adhérente
Sartén antiaderente

| art. | Ø cm. | h. cm. | € |
|----------|-------|--------|--------|
| 16117-20 | 20 | 4,0 | 38,49 |
| 16117-24 | 24 | 5,0 | 47,84 |
| 16117-28 | 28 | 5,0 | 58,69 |
| 16117-32 | 32 | 5,3 | 71,66 |
| 16117-36 | 36 | 6,0 | 86,53 |
| 16117-40 | 40 | 7,0 | 102,01 |



Frypan, non stick
Padella, antiaderente
Bratpfanne, nichttaftend
Poêle, anti-adhérente
Sartén antiaderente

| art. | Ø cm. | h. cm. | - | € |
|----------|-------|--------|-----|-------|
| 11617-20 | 20 | 4,7 | - | 36,48 |
| 11617-24 | 24 | 4,7 | - | 42,61 |
| 11617-28 | 28 | 5,5 | - | 49,75 |
| 11617-32 | 32 | 5,5 | - | 57,69 |
| 11617-36 | 36 | 5,7 | NEW | 68,14 |
| 11617-40 | 40 | 6,0 | NEW | 75,07 |

An innovative surface characterized by very hard reliefs that protect the coating with 3 times higher scratch resistance. The rough shape increases the heat exchange surface and thermal conductivity, allowing uniform cooking and energy saving. Perfect non-stick: excellent release of food during cooking and easy to clean even in the dishwasher.

Un'innovativa superficie caratterizzata da rilievi durissimi che proteggono il rivestimento con resistenza ai graffi 3 volte superiore. La conformazione rugosa aumenta la superficie di scambio e la conducibilità termica, permettendo cotture uniformi e risparmio di energia. Perfetta antiaderenza: ottimo rilascio del cibo in cottura e facile da pulire anche in lavastoviglie.



Frypan, non stick, cast iron handle
Padella bombata antiaderente, manico ferro
Bratpfanne, nichttaftend, Gusseisen-Stiel
Poêle bombé, anti-adhérente, queue fonte
Sartén antiaderente, mango hierro

| art. | Ø cm. | h. cm. | € |
|----------|-------|--------|-------|
| 16113-20 | 20 | 5,5 | 30,15 |
| 16113-24 | 24 | 6,5 | 34,57 |
| 16113-28 | 28 | 7,0 | 41,91 |
| 16113-32 | 32 | 7,5 | 51,05 |
| 16113-36 | 36 | 8,0 | 64,62 |
| 16113-40 | 40 | 8,5 | 80,10 |



Frypan, non stick, cast iron handle
Padella antiaderente, manico ferro
Bratpfanne, nichttaftend, Gusseisen-Stiel
Poêle, anti-adhérente, queue fonte
Sartén antiaderente, mango hierro

| art. | Ø cm. | h. cm. | € |
|----------|-------|--------|-------|
| 16717-20 | 20 | 4,0 | 21,51 |
| 16717-24 | 24 | 5,0 | 28,44 |
| 16717-28 | 28 | 5,0 | 35,68 |
| 16717-32 | 32 | 5,3 | 45,33 |
| 16717-36 | 36 | 6,0 | 58,49 |
| 16717-40 | 40 | 7,0 | 76,68 |



Crêpes pan, non stick
Padella crêpes, antiaderente
Crêpepfanne, nichttaftend
Poêle à crêpes, anti-adhérente
Sartén crêpes antiaderente

| art. | Ø cm. | € |
|----------|-------|-------|
| 16118-24 | 24 | 48,04 |



Non-stick blinis pan
Padella per blini, antiaderente
Blinis-Pfännchen, nichttaftend
Poêle à blinis, anti-adhérente
Sartén blinis, antiaderente

| art. | Ø cm. | h. cm. | € |
|----------|-------|--------|-------|
| 16719-12 | 12 | 2 | 20,70 |



Crêpes pan, non-stick

Padella crêpes antiaderente
Crêpes-Pfanne, nichtaftend
Tuile à crêpes anti-adhérente
Sartén para crêpes, antiadherente

| art. | Ø cm. | € |
|----------|-------|-------|
| 16712-22 | 22 | 29,55 |
| 16712-26 | 26 | 33,77 |
| 16712-30 | 30 | 40,60 |



Bake roasting pan

Tegame
Pfanne
Plat à four
Rustidera

| art. | cm. | h. cm. | € |
|-----------|-------|--------|-------|
| 16941-40 | 40x26 | 7,5 | 61,91 |
| 16941-45 | 45x30 | 7,5 | 66,53 |
| 16941-50 | 50x30 | 8,0 | - |
| 16941-61* | 61x43 | 9,0 | - |

*For 2/1 GN ovens. – Per forno GN 2/1.



Bake roasting pan

Tegame
Pfanne
Plat à four
Rustidera

| art. | cm. | h. cm. | € |
|-----------|-------|--------|--------|
| 16943-40 | 40x26 | 7,5 | 69,95 |
| 16943-45 | 45x30 | 7,5 | 78,79 |
| 16943-50 | 50x30 | 8,0 | 90,15 |
| 16943-60 | 60x35 | 9,0 | 124,72 |
| 16943-61* | 61x43 | 9,0 | 136,68 |

*For 2/1 GN ovens. – Per forno GN 2/1.



Bake roasting, non stick

Tegame, antiaderente
Pfanne, nichtaftend
Plat à four, anti-adhérente
Rustidera antiadherente

| art. | cm. | h. cm. | € |
|-----------|-------|--------|--------|
| 16947-50 | 50x30 | 8,0 | - |
| 16947-60 | 60x35 | 9,0 | 206,73 |
| 16947-61* | 61x43 | 9,0 | - |

*For 2/1 GN ovens. – Per forno GN 2/1.



Lid for roasting pans

Coperchio per tegami
Deckel für Bräter
Couvercle pour plaques à rôtir
Tapa para rustidera

| art. | cm. | € |
|----------|-------|-------|
| 16948-40 | 40x26 | 26,93 |
| 16948-45 | 45x30 | 28,94 |
| 16948-50 | 50x30 | 32,06 |
| 16948-60 | 60x35 | 40,10 |
| 16948-61 | 61x43 | 43,11 |



Bake roasting pan

Tegame basso
Pfanne, flach
Plat à four bas
Bandeja horno

| art. | cm. | h. cm. | € |
|----------|-------|--------|-------|
| 16944-45 | 45x30 | 4 | 48,74 |
| 16944-50 | 50x30 | 4 | 54,17 |
| 16944-60 | 60x35 | 4 | 69,35 |



Roasting pan with cover

Brasiera con coperchio
Brasiere mit Deckel
Braisière avec couvercle
Rustidera alta con tapa

| art. | cm. | h. cm. | lt. | € |
|----------|-------|--------|-----|---|
| 16965-40 | 40x26 | 15 | 14 | - |
| 16965-50 | 50x30 | 15 | 21 | - |



Fish kettle

Pesciera
Fisch-Kochkessel
Poissonnière
Hervidor pescado

| art. | cm. | h. cm. | lt. | € |
|----------|-------|--------|-----|--------|
| 16939-50 | 50x15 | 12 | 9 | 137,58 |
| 16939-60 | 60x17 | 13 | 13 | 153,77 |
| 16939-70 | 70x19 | 14 | 18 | 194,67 |
| 16939-80 | 80x24 | 17 | 30 | 283,81 |

Equipped with grid and cover.
Fornita con griglia e coperchio.



Bain-marie pot

Bagnomaria
Wasserbadkasserolle
Casserole bain-marie
Baño maria

| art. | Ø cm. | h. cm. | lt. | € |
|----------|-------|--------|-----|-------|
| 16910-14 | 14 | 16 | 2,5 | - |
| 16910-16 | 16 | 18 | 3,7 | 35,07 |
| 16910-18 | 18 | 20 | 5,0 | - |
| 16910-20 | 20 | 22 | 7,0 | - |

STEEL FRYING PANS PADELLE FERRO



Iron is ideal for cooking at high temperatures because its low capacity of heat transmission prevents temperature leaps. As it is non-stick, food does not stick to it. It withstands very high temperatures and improves its performance with use. Iron pans are perfect for fried food, omelettes or fine crêpes. Wash the black iron pan in water as little as possible and always keep it greased. Iron pans are ideal also for cooking on induction hobs.

Il ferro è ottimo per le cotture a fuoco molto vivo perché, non avendo un'alta capacità di trasmettere calore, evita improvvisi sbalzi di temperatura. Essendo un materiale antiaderente, evita l'attaccamento dei cibi. Sopporta temperature elevatissime e col tempo migliora il suo rendimento. I recipienti in ferro sono i più adatti per frittture, omelette o sottili crêpes. La padella in ferro nera va lavata con acqua il meno possibile e mantenuta sempre unta. Il ferro è il materiale ideale anche per cotture a induzione.



Blacksteel fish pan
Padella ovale
Fischeisenpfanne, oval
Coupe ovale
Sartén oval

| art. | cm. | h. cm. | € |
|----------|-------|--------|--------|
| 41719-36 | 36x26 | 5,0 | 76,68 |
| 41719-40 | 40x28 | 5,5 | 100,90 |



Blacksteel crêpes pan
Padella crêpes
Crêpes Eisenpfanne
Coupe lyonnaise à crêpes
Sartén crêpes

| art. | Ø cm. | h. cm. | € |
|----------|-------|--------|-------|
| 11718-20 | 20 | 2 | 14,47 |
| 11718-22 | 22 | 2 | 17,19 |
| 11718-24 | 24 | 2 | 17,99 |



Blinis pan
Padella per blini
Blinis-Eisenpfännchen
Poêle à blinis
Sartén blinis

| art. | Ø cm. | h. cm. | € |
|----------|-------|--------|-------|
| 11715-12 | 12 | 2 | 12,06 |



Heavy blacksteel frypan
Padella lionese, pesante
Schwere Eisenpfanne
Coupe lyonnaise extra-forte
Sartén honda pesada

| art. | Ø cm. | h. cm. | € |
|----------|-------|--------|--------|
| 11714-20 | 20 | 3,8 | 24,42 |
| 11714-22 | 22 | 4,0 | 28,54 |
| 11714-24 | 24 | 4,5 | 31,56 |
| 11714-26 | 26 | 4,5 | 35,98 |
| 11714-28 | 28 | 4,5 | 39,20 |
| 11714-32 | 32 | 5,0 | 49,35 |
| 11714-36 | 36 | 5,5 | 59,19 |
| 11714-40 | 40 | 5,5 | 70,35 |
| 11714-45 | 45 | 5,5 | 99,29 |
| 11714-50 | 50 | 6,0 | 114,27 |



Blacksteel frypan
Padella lionese
Eisenpfanne
Coupe lyonnaise
Sartén honda

| art. | Ø cm. | h. cm. | € |
|----------|-------|--------|-------|
| 11716-16 | 16 | 4,0 | 11,66 |
| 11716-20 | 20 | 4,5 | 13,57 |
| 11716-22 | 22 | 4,5 | 15,48 |
| 11716-24 | 24 | 5,0 | 17,49 |
| 11716-26 | 26 | 5,5 | 19,20 |
| 11716-28 | 28 | 5,5 | 21,31 |
| 11716-32 | 32 | 6,0 | 26,73 |
| 11716-36 | 36 | 6,5 | 39,60 |
| 11716-40 | 40 | 7,0 | 46,03 |
| 11716-45 | 45 | 8,0 | 60,00 |



Blacksteel paella pan
Padella per paella
Paella Eisenpfanne
Coupe lyonnaise à paella
Paellera

| art. | Ø cm. | h. cm. | € |
|----------|-------|--------|--------|
| 11717-34 | 34 | 5,0 | 36,98 |
| 11717-37 | 37 | 5,5 | 40,20 |
| 11717-42 | 42 | 6,0 | 46,23 |
| 11717-47 | 47 | 6,5 | 58,29 |
| 41717-60 | 60 | 6,5 | 139,49 |



Blacksteel fish pan
Padella ovale
Fischeisenpfanne, oval
Coupe ovale
Sartén oval

| art. | cm. | € |
|----------|-------|--------|
| 41703-38 | 38x26 | 119,39 |



Wok pan
Wok
Wok-Pfanne
Poêle chinoise
Wok

| art. | Ø cm. | h. cm. | € |
|----------|-------|--------|-------|
| 11713-32 | 32 | 10 | 41,10 |
| 11713-40 | 40 | 11 | 56,28 |



Silicone sleeve
Coprimanico silicone
Silikon-Stielhülle
Revêtement manche en silicone
Cubre mango silicona

| art. | Ø cm. | col. | € |
|----------|-------|------|------|
| 11710-AA | 20-36 | ● | 5,03 |
| 11710-AB | 40-50 | ● | 5,03 |

Heat resistant up to 230°C. Resistenza al calore fino a 230°C. Suits items! Per art: 16717, 16113, 16712, 11714, 11716, 11718, 11713, 11721.



Fry pan
Padella per friggere
Frittier-Pfanne
Tuile à frire
Sartén freidora

| art. | Ø cm. | h. cm. | lt. | € |
|----------|-------|--------|------|--------|
| 41707-32 | 32 | 9,8 | 6,0 | 54,67 |
| 41707-36 | 36 | 11,0 | 8,8 | 69,45 |
| 41707-40 | 40 | 13,4 | 12,2 | 83,82 |
| 41707-45 | 45 | 15,0 | 17,3 | 111,76 |
| 41707-50 | 50 | 17,6 | 23,5 | 146,83 |



Wire basket
Cestello per friggere
Frittier-Rost
Grille à frire
Cesta escurrefrito

| art. | Ø cm. | h. cm. | € |
|----------|-------|--------|--------|
| 41708-32 | 29,5 | 8,7 | 56,58 |
| 41708-36 | 32,6 | 9,3 | 73,26 |
| 41708-40 | 39,0 | 12,4 | 96,38 |
| 41708-45 | 43,0 | 15,0 | 136,88 |
| 41708-50 | 46,5 | 17,0 | - |

ENAMELLED CAST IRON GHISA SMALTATA

COOKWARE
PENTOLAME



Suitable for use on all cooking hobs (gas, electric, ceramic, induction) and ovens (gas, oil, coal or wood) except microwave. A perfect harmony of cast iron, enamel and high quality. Designed and constructed to absorb and spread the heat evenly. Cast iron is suitable for all cooking techniques, for soups, roasts, rice, desserts, for braise that require a long cooking and likewise ideal for meats and grilled vegetables as it enhances flavors and aromas like barbecue style. Cast iron also features non-stick. The high temperature of the pan sears the meat surface. All the flavor, water and nutritional values remain sealed in the food. When cooking in casseroles, the steam generated thanks to the special design of the cover condenses falling back into the food not only retaining flavors and aromas but providing the best protection for nutrients and contributing to a healthy diet. Cast iron is a material 100% recyclable and therefore environmentally friendly. Moreover, thanks to its ability to retain heat for a long time it allows a considerable saving of energy. With closed lid on the table, the pot will preserve the temperature for a second serving. Cast iron retains the heat but as well the cold... can be used to keep the food fresh. Stored for a short time in the refrigerator, keeps food cool during hot summer days, ideal for serving pasta or rice salads, etc. Practical and easy to clean. These cast iron pots and pans are dishwasher safe thanks to the special technology applied to their enameling method. Ergonomic knobs and handles made of cast iron and stainless steel, suitable for use on all heat sources and ovens except microwave. Be careful, they heat up during cooking, it is recommended to handle with a dry thick cloth.

Idonee all'uso su tutte le fonti di cottura (gas, elettriche, vetroceramica, induzione) e forni (gas, petrolio, carbone o legna) ad esclusione di microonde. Una perfetta armonia tra ghisa, smalto e alta qualità. Progettate e costruite per assorbire e diffondere il calore in modo uniforme. La ghisa è adatta a tutte le tecniche di cottura, per zuppe, arrostiti, risotti, dolci, per piatti che richiedono una lunga cottura tipo brasati e allo stesso modo ideale per carni e verdure alla griglia in quanto ne esalta sapori ed aromi in stile barbecue. La ghisa ha anche caratteristiche di antiaderenza. La temperatura elevata della padella cauterizza la superficie della carne. Tutto il sapore, l'acqua e i valori nutrizionali rimangono sigillati nel cibo. Nella cottura in casseruole, il vapore generato grazie al particolare design del coperchio si condensa ricadendo e mescolandosi nuovamente nel cibo non solo trattenendo sapori e aromi ma fornendo la miglior protezione alle sostanze nutrienti e contribuendo ad una dieta sana. La ghisa è un materiale riciclabile al 100% e quindi ecologico. Inoltre, grazie alla sua capacità di mantenere il calore per lungo tempo consente un notevole risparmio di energia permettendo di cuocere a fuoco basso. Anche a tavola mantengono in cibi in temperatura. La ghisa mantiene però il caldo come pure il freddo... può essere usata per mantenere il cibo fresco. Riposta per un breve periodo in frigorifero, mantiene il cibo fresco nelle calde giornate estive e ideale per servire insalate di pasta, riso, farro, ecc., ecc. Pratica e facile da pulire. Queste casseruole e padelle in ghisa sono lavabili in lavastoviglie, per merito della speciale tecnologia applicata al metodo di smaltatura. Manicatura e pomoli dal design ergonomico sono in ghisa e inox. Durante la cottura si raccomanda di maneggiare con un panno consistente e asciutto per evitare di scottarsi.

SERIES ANATOLIA



Enamelled cast iron 3 coats, 2 fires.
Material thickness: bottom 4 mm, edges 3,5 mm.

Ghisa smaltata 3 strati di rivestimento antiaderente, doppia cottura.
Spessore materiale: fondo 4 mm, bordi 3,5 mm.



NEW

Saucepot with lid
Casseruola alta con coperchio
Fleischtopf mit Deckel
Brasière avec couvercle
Cacerola alta con tapa

| art. | Ø cm. | h. cm. | lt. | Por. | € |
|----------|-------|--------|------|------|--------|
| 44275B26 | 26 | 11,5 | 4,35 | 4-6 | 170,25 |



NEW

Saucepot with lid
Casseruola alta con coperchio
Fleischtopf mit Deckel
Brasière avec couvercle
Cacerola alta con tapa

| art. | Ø cm. | h. cm. | lt. | Por. | € |
|----------|-------|--------|------|------|--------|
| 44275A26 | 26 | 11,5 | 4,35 | 4-6 | 170,25 |



NEW

Saucepot with lid
Casseruola alta con coperchio
Fleischtopf mit Deckel
Brasière avec couvercle
Cacerola alta con tapa

| art. | Ø cm. | h. cm. | lt. | Por. | € |
|----------|-------|--------|------|------|--------|
| 44275G26 | 26 | 11,5 | 4,35 | 4-6 | 170,25 |



Saucepot with lid

Casseruola alta con coperchio
Fleischtopf mit Deckel
Brasière avec couvercle
Cacerola alta con tapa

| art. | Ø cm. | lt. | Por. | € |
|----------|-------|------|-------|--------|
| 44201R16 | 16 | 1,0 | 1-2 | 92,86 |
| 44201R20 | 20 | 2,6 | 2-3 | 130,85 |
| 44201R24 | 24 | 4,5 | 4-5 | 146,73 |
| 44201R28 | 28 | 6,7 | 6-8 | 179,29 |
| 44201R32 | 32 | 10,0 | 12-16 | 219,29 |



Saucepot with lid

Casseruola alta con coperchio
Fleischtopf mit Deckel
Brasière avec couvercle
Cacerola alta con tapa

| art. | Ø cm. | lt. | Por. | € |
|----------|-------|------|-------|--------|
| 44201N16 | 16 | 1,0 | 1-2 | 92,86 |
| 44201N20 | 20 | 2,6 | 2-3 | 130,85 |
| 44201N24 | 24 | 4,5 | 4-5 | 146,73 |
| 44201N28 | 28 | 6,7 | 6-8 | 179,29 |
| 44201N32 | 32 | 10,0 | 12-16 | 219,29 |



W

Platter with magnetic feature

Sottopentola magnetico
Untersetzer, magnetisch
Sous-plat magnétique
Posavasos magnético

| art. | Ø cm. | € |
|----------|-------|-------|
| 44207-20 | 20 | 27,64 |

Beechwood. – Faggio.



Casserole pot with glass lid

Casseruola bassa coperchio vetro
Bratentopf mit Glasdeckel
Sautoir avec couvercle verre
Cacerola baja con tapa vidrio

| art. | Ø cm. | lt. | Por. | € |
|----------|-------|-----|------|--------|
| 44204R24 | 24 | 2,4 | 4 | 134,07 |
| 44204R28 | 28 | 3,4 | 4-6 | 141,91 |



NEW

Casserole pot with lid

Casseruola bassa coperchio
Bratentopf mit Deckel
Sautoir avec couvercle
Cacerola baja con tapa

| art. | Ø cm. | h. cm. | lt. | Por. | € |
|----------|-------|--------|-----|------|--------|
| 44204R32 | 32 | 9 | 5,7 | 6-8 | 201,20 |



NEW

Mini wok

Mini wok
Mini-Wok
Mini wok
Mini wok

| art. | Ø cm. | h. cm. | lt. | Por. | € |
|----------|-------|--------|------|------|-------|
| 44270-16 | 16 | 8 | 0,75 | 1 | 53,87 |



Oval saucepan with lid

Casseruola ovale con coperchio
Ovaler Bratentopf mit Deckel
Casserole ovale avec couvercle
Cacerola oval con tapa

| art. | Ø cm. | lt. | Por. | € |
|----------|-------|-----|------|--------|
| 44202R29 | 29 | 4,8 | 6 | 158,79 |



Oval saucepan with lid

Casseruola ovale con coperchio
Ovaler Bratentopf mit Deckel
Casserole ovale avec couvercle
Cacerola oval con tapa

| art. | Ø cm. | lt. | Por. | € |
|----------|-------|-----|------|--------|
| 44202N25 | 25 | 3,3 | 4 | 147,63 |
| 44202N29 | 29 | 4,8 | 6 | 158,79 |





Terrine pot
Terrina
Pasteten-Pfanne
Terrine rectangle
Fuente rectangular

| art. | cm. | lt. | Por. | € |
|----------|----------|------|------|-------|
| 44219R26 | 11x33x10 | 1,05 | 2-4 | 92,06 |



Bread pot
Teglia pane
Brottopf
Terrina à pain
Olla para pan

| art. | cm. | lt. | Por. | € |
|----------|----------|------|------|--------|
| 44219R31 | 13x31x10 | 2,13 | 2-4 | 154,57 |



NEW

Bread pot
Teglia pane
Brottopf
Terrina à pain
Olla para pan

| art. | Ø cm. | h. cm. | lt. | Por. | € |
|----------|-------|--------|------|------|--------|
| 44219R24 | 24 | 10,8 | 3,56 | 4-6 | 179,59 |



NEW

Baking tray
Teglia
Backblech
Plat à four
Plato horno

| art. | Ø cm. | h. cm. | lt. | € |
|----------|-------|--------|------|--------|
| 44253-30 | 30 | 5 | 2,72 | 102,21 |



Grill pan
Padella grill
Grill-Pfanne
Poêle grill
Sartén grill

| art. | cm. | lt. | Por. | € |
|----------|-------|-----|------|--------|
| 44209R26 | 26x26 | 2,2 | 4 | 99,80 |
| 44209R32 | 26x32 | 2,6 | 6 | 121,91 |



NEW

Grill pan divided
Padella grill divisa
Grill-Pfanne geteilt
Poêle grill divisée
Sartén grill dividida

| art. | cm. | h. cm. | lt. | Por. | € |
|----------|-------|--------|------|------|--------|
| 44211R03 | 26x30 | 5,5 | 2,38 | 2 | 112,26 |



NEW

Grill pan
Padella grill
Grill-Pfanne
Poêle grill
Sartén grill

| art. | cm. | h. cm. | lt. | Por. | € |
|----------|-------|--------|------|------|-------|
| 44211R01 | 26x26 | 5,5 | 2,51 | 4-6 | 91,46 |



NEW

Grill pan divided

Padella grill divisa
Grill-Pfanne geteilt
Poêle grill divisée
Sartén grill dividida

| art. | cm. | h. cm. | lt. | Por. | € |
|----------|-------|--------|------|------|-------|
| 44211R02 | 26x30 | 5,5 | 2,68 | 4-6 | 97,28 |



Grill pan

Padella grill
Grill-Pfanne
Poêle grill
Sartén grill

| art. | cm. | lt. | Por. | € |
|----------|-------|------|------|-------|
| 44210-26 | 26x26 | 2,20 | 4 | 70,65 |
| 44210-32 | 26x32 | 2,75 | 6 | 74,17 |

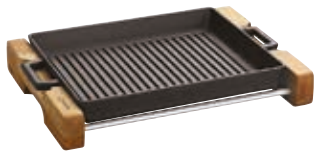

Grill pan with wooden service stand

Padella grill con tagliere a servire legno
Grill-Pfanne mit Service-Holzbrett
Poêle grill avec support à servir bois
Sartén grill con tabla madera

| art. | cm. | lt. | Por. | € |
|----------|-------|------|------|--------|
| 44210S32 | 26x32 | 2,75 | 6 | 115,68 |

Beechwood. – Faggio.



Grill pan

Padella grill
Grill-Pfanne
Poêle grill
Sartén grill

| art. | cm. | lt. | Por. | € |
|----------|-------|-----|------|-------|
| 44210-42 | 31x42 | 4,5 | 8 | 89,85 |



Bake roasting dish

Tegame rettangolare
Pfanne, rechteckig
Plat rectangulaire
Rustidera

| art. | cm. | Por. | € |
|----------|-------|------|--------|
| 44218R30 | 22x30 | 6-8 | 100,70 |
| 44218R40 | 26x40 | 8-12 | 124,52 |



Grill pan

Bistecchiera
Grill-Pfanne
Poêle grill
Sartén grill

| art. | Ø cm. | lt. | Por. | € |
|----------|-------|------|------|-------|
| 44212-30 | 30 | 2,35 | 4-6 | 70,35 |



Grill pan

Bistecchiera
Grill-Pfanne
Poêle grill
Sartén grill

| art. | Ø cm. | Por. | € |
|----------|-------|------|-------|
| 44214-25 | 25 | 2-3 | 38,89 |



NEW

Grill pan

Padella grill
Grill-Pfanne
Poêle grill
Sartén grill

| art. | Ø cm. | h. cm. | Por. | € |
|----------|-------|--------|------|--------|
| 44252-32 | 32 | 6 | 6-8 | 122,21 |

Silicone sleeve. – Coprimanico silicone.



Grill pan

Bistecchiera
Grill-Pfanne
Poêle grill
Sartén grill

| art. | cm. | Por. | € |
|----------|-------|------|-------|
| 44213-24 | 24x24 | 1-2 | 43,72 |
| 44213-36 | 21x36 | 2-4 | 47,54 |



Griddle plate, dual side, reversible

Griglia reversibile
Grill-Platte, zweiseitig, reversible
Grill rectangle, reversible
Parrilla reversible

| art. | cm. | Por. | € |
|----------|-------|------|-------|
| 44224-22 | 22x15 | 1-2 | 44,62 |



Griddle plate, dual side, reversible

Griglia reversibile
Grill-Platte, zweiseitig, reversible
Grill rectangle, reversible
Parrilla reversible

| art. | cm. | Por. | € |
|----------|-------|------|-------|
| 44217-45 | 26x47 | 6-8 | 83,31 |



Grill plate and wooden platter

Griglia reversibile con tagliere legno
Grill-Platte mit Service-Holzbrett
Grill avec plaque à servir bois
Parrilla con tabla madera

| art. | cm. | Por. | € |
|----------|-------|------|--------|
| 44224S22 | 22x15 | 1-2 | 103,31 |

Beechwood. – Faggio.

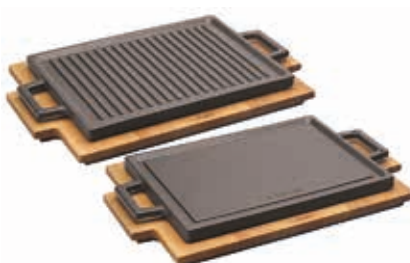

Griddle with wooden platter

Griglia con tagliere legno
Grill-Platte mit Holzbrett
Grill rectangle avec planche bois
Parrilla con tabla madera

| art. | cm. | Por. | € |
|----------|-------|------|--------|
| 44226S30 | 22x30 | 2-3 | 136,28 |

Beechwood. – Faggio.



Table barbecue

Barbecue da tavola
Tischgrillplatte
Barbecue de table
Parrilla de mesa

| art. | cm. | Por. | € |
|----------|-------|------|--------|
| 44225-22 | 22x15 | 1-2 | 162,81 |

Fuel holder not included. See item 44220-AA.
Portacombustibile non incluso. Vedi codice 44220-AA.



Table barbecue

Barbecue da tavola
Tischgrillplatte
Barbecue de table
Parrilla de mesa

| art. | cm. | Por. | € |
|----------|-------|------|--------|
| 44227-30 | 22x30 | 2-3 | 145,93 |

Fuel holder not included. See item 44220-AA.
Portacombustibile non incluso. Vedi codice 44220-AA.





Grill pan and wooden service stand
Padella grill con tagliere a servire legno
Grill-Pfanne mit Service-Holzbrett
Poêle grill avec plache à servir bois
Sartén grill con tabla madera

| art. | cm. | Por. | € |
|----------|-------|------|--------|
| 44216S16 | 16x16 | 1 | 105,22 |

Cups not included. – Ciotoline non incluse.



Grill pan with wooden platter
Padella grill con tagliere legno
Grill-Pfanne mit Holzbrett
Poêle grill avec plache bois
Sartén grill con tabla madera

| art. | cm. | Por. | € |
|----------|-------|------|-------|
| 44215S16 | 16x16 | 1 | 71,25 |

Beechwood. – Faggio.



Fajita plate with wooden platter
Piatto fajita con tagliere legno
Fajitaplatte mit Holzbrett
Plat à fajitas avec planche bois
Fuente fajitas con tabla madera

| art. | cm. | Por. | € |
|----------|-------|------|-------|
| 44228S23 | 17x23 | 1 | 81,81 |

Beechwood. – Faggio.



Fish plate with wooden platter
Piatto pesce con tagliere legno
Fischplatte mit Holzbrett
Plat à poisson avec planche bois
Fuente pescado con tabla madera

| art. | cm. | Por. | € |
|----------|-------|------|-------|
| 44220S24 | 15x24 | 1-2 | 80,80 |

Beechwood. – Faggio.



Fish plate with wooden platter
Piatto pesce con tagliere legno
Fischplatte mit Holzbrett
Plat à poisson avec planche bois
Fuente pescado con tabla madera

| art. | cm. | Por. | € |
|----------|-----------|------|-------|
| 44221S30 | 15,5x29,5 | 1-2 | 70,85 |

Beechwood. – Faggio.



Pizza pan with wooden platter
Piatto pizza con tagliere legno
Pizza-Platte mit Holzbrett
Plat à pizza avec planche bois
Fuente para pizza con tabla madera

| art. | Ø cm. | Por. | € |
|----------|-------|------|--------|
| 44222S20 | 20 | 1 | 92,26 |
| 44222S28 | 28 | 1 | 130,05 |

Beechwood. – Faggio.



Oval plate with wooden platter
Piatto ovale con tagliere legno
Ovalplatte mit Holzbrett
Plat oval avec planche bois
Fuente ovale con tabla madera

| art. | cm. | Por. | € |
|----------|-----------|------|-------|
| 44230S14 | 21x14x2,5 | 1-2 | 76,58 |

Beechwood. – Faggio.



Round plate with wooden platter
Piatto tondo con tagliere legno
Platte mit Holzbrett, rund
Plat rond avec planche bois
Fuente redonda con tabla madera

| art. | Ø cm. | Por. | € |
|----------|-------|------|-------|
| 44232S16 | 16 | 1-2 | 70,25 |
| 44232S20 | 20 | 2-3 | 98,09 |

Beechwood. – Faggio.



Round plate with wooden platter
Piatto tondo con tagliere legno
Platte mit Holzbrett, rund
Plat rond avec planche bois
Fuente redonda con tabla madera

| art. | Ø cm. | lt. | Por. | € |
|----------|-------|------|------|--------|
| 44233-20 | 20 | 0,74 | 3-4 | 100,60 |

Cups not included. – Ciotoline non incluse.



Rectangular pan with wooden service stand

Tegame con tagliere a servire legno
Pfanne mit Service-Holzbrett
Poêle avec support à servir bois
Sartén con tabla madera

| art. | cm. | Por. | € |
|----------|-------|------|-------|
| 44237S15 | 12x15 | 1-2 | 66,13 |

Beechwood. – Faggio.



Service dish with wooden stand

Piatto servire con tagliere legno
Servierplatte mit Holzbrett
Plat à servir avec support en bois
Plato para servir con tabla madera

| art. | cm. | Por. | € |
|----------|-------|------|--------|
| 44245S32 | 32x20 | 1 | 129,44 |

Beechwood. – Faggio.



Service dish with wooden stand

Piatto servire con tagliere legno
Servierplatte mit Holzbrett
Plat à servir avec support en bois
Plato para servir con tabla madera

| art. | cm. | Por. | € |
|----------|-------|------|--------|
| 44244S36 | 36x24 | 4-6 | 166,03 |

Beechwood. – Faggio.



Round pan

Padella tonda
Pfanne, rund
Poêle ronde

Sartén grill redonda

| art. | Ø cm. | Por. | € |
|----------|-------|------|-------|
| 44234-12 | 12 | 1 | 36,38 |
| 44234-16 | 16 | 1-2 | 46,73 |



Pan and wooden platter

Padella con tagliere legno
Pfanne mit Holzbrett
Poêle avec plache bois
Sartén grill con tabla madera

| art. | Ø cm. | lt. | Por. | € |
|----------|-------|------|------|-------|
| 44234S16 | 16 | 0,45 | 1-2 | 75,07 |

Beechwood. – Faggio.



Hot pot with wooden stand

Casseroola con tagliere legno
Schüssel mit Holzbrett
Bol avec support en bois
Bol con tabla madera

| art. | Ø cm. | h. cm. | lt. | Por. | € |
|----------|-------|--------|------|------|-------|
| 44246S14 | 14 | 4 | 0,32 | 1 | 63,62 |
| 44246S17 | 17 | 4 | 0,59 | 1 | 76,78 |

Beechwood. – Faggio.



NEW

Three divided dish

Piatto tre scomparti
Platte 3 Fächer
Assiette 3 compartiments
Plato tres compartimentos

| art. | cm. | h. cm. | lt. | Por. | € |
|----------|-------|--------|------|------|-------|
| 44271-33 | 12x33 | 4,5 | 0,75 | 3 | 90,35 |

Beechwood. – Faggio.



NEW

Serving dish

Piatto servire
Servierplatte
Plat à servir
Plato para servir

| art. | cm. | h. cm. | lt. | Por. | € |
|----------|-------|--------|------|------|-------|
| 44220S15 | 15x26 | 3,8 | 0,29 | 1 | 56,58 |

Beechwood. – Faggio.



Pan with wooden platter

Tegame con tagliere legno
Pfanne mit Holzbrett
Poêle avec plaque bois
Paellera con tabla madera

| art. | Ø cm. | cm. | lt. | Por. | € |
|----------|-------|-----------|------|------|-------|
| 44247S16 | 16 | 23,5x18,5 | 0,44 | 1-2 | 71,36 |

Beechwood. – Faggio.



Soufflé pot with wooden platter

Coppa soufflé con supporto legno
Ramekin mit Holzbrett
Ramequin avec planche bois
Fuente soufflé con tabla madera

| art. | Ø cm. | lt. | Por. | € |
|----------|-------|------|------|-------|
| 44240S08 | 8 | 0,15 | 1 | 40,00 |

Beechwood. – Faggio.



Soufflé pot

Coppa soufflé
Ramekin
Ramequin
Fuente soufflé

| art. | Ø cm. | h. cm. | lt. | € |
|----------|-------|--------|------|-------|
| 44240-08 | 8 | 4,5 | 0,15 | 20,60 |

Enamelled cast iron. – Ghisa smaltata.



W

Tortillas cup

Ciotola tortillas
Tortillas-Schale
Coupe-tortillas
Copa tortillas

| art. | Ø cm. | € |
|----------|-------|-------|
| 44241-19 | 19 | 84,22 |

Iroko wood. – Legno iroko.



PR

Sauce bowl

Coppa salsa
Saucentasse
Bol à sauce
Copa para salsa

| art. | Ø cm. | h. cm. | € |
|----------|-------|--------|---|
| 44242-00 | 6 | 2,7 | - |

Porcelain. – Porcellana.



MF

Sauce bowl

Coppa salsa
Saucentasse
Bol à sauce
Copa para salsa

| art. | Ø cm. | h. cm. | € |
|----------|-------|--------|------|
| 44243-00 | 7,1 | 3,5 | 3,12 |

Melamine. – Melamina.



Silicone sleeves

Coprimaniglia silicone
Silikon-Griffhüllen
Revêtement en silicone pour poignées
Cubre asas de silicona

| art. | col. | € |
|----------|------|------|
| 44208G00 | ● | 7,74 |
| 44208R00 | ● | 7,74 |



SS

Fuel holder

Portacombustibile
Brennstoffhalterung
Porte Brûleur
Contenedor de combustible

| art. | cm. | h. cm. | € |
|----------|----------|--------|-------|
| 44220-AA | 9,3x14,9 | 4,8 | 18,99 |



NEW

Hot pot with wooden stand

Casseruola con tagliere legno
Schüssel mit Holzbrett
Bol avec support en bois
Bol con tabla madera

| art. | Ø cm. | h. cm. | lt. | Por. | € |
|----------|-------|--------|------|------|-------|
| 44272-11 | 11 | 5,5 | 0,22 | 1 | 64,12 |
| 44272-14 | 14 | 5,5 | 0,36 | 1 | 80,90 |
| 44272-17 | 17 | 5,5 | 0,44 | 1-2 | 93,26 |

Beechwood. – Faggio.



NEW

Fish plate with wooden platter

Piatto pesce con tagliere legno
Fischplatte mit Holzbrett
Plat à poisson avec planche bois
Fuente pescado con tabla madera

| art. | cm. | h. cm. | lt. | Por. | € |
|----------|-------|--------|------|------|--------|
| 44273-24 | 15x24 | 5 | 0,44 | 1-2 | 96,18 |
| 44273-32 | 20x32 | 5 | 1,10 | 2 | 120,60 |

Beechwood. – Faggio.



NEW

Fajita plate with wooden platter

Piatto fajita con tagliere legno
Fajitaplatte mit Holzbrett
Plat à fajitas avec planche bois
Fuente fajitas con tabla madera

| art. | cm. | h. cm. | lt. | Por. | € |
|----------|-------|--------|------|------|-------|
| 44274-24 | 18x24 | 4 | 0,55 | 1 | 92,86 |

Beechwood. – Faggio.



MISCELLANEOUS COMPLEMENTI

STAINLESS STEEL COOKWARE
PENTOLAME INOX

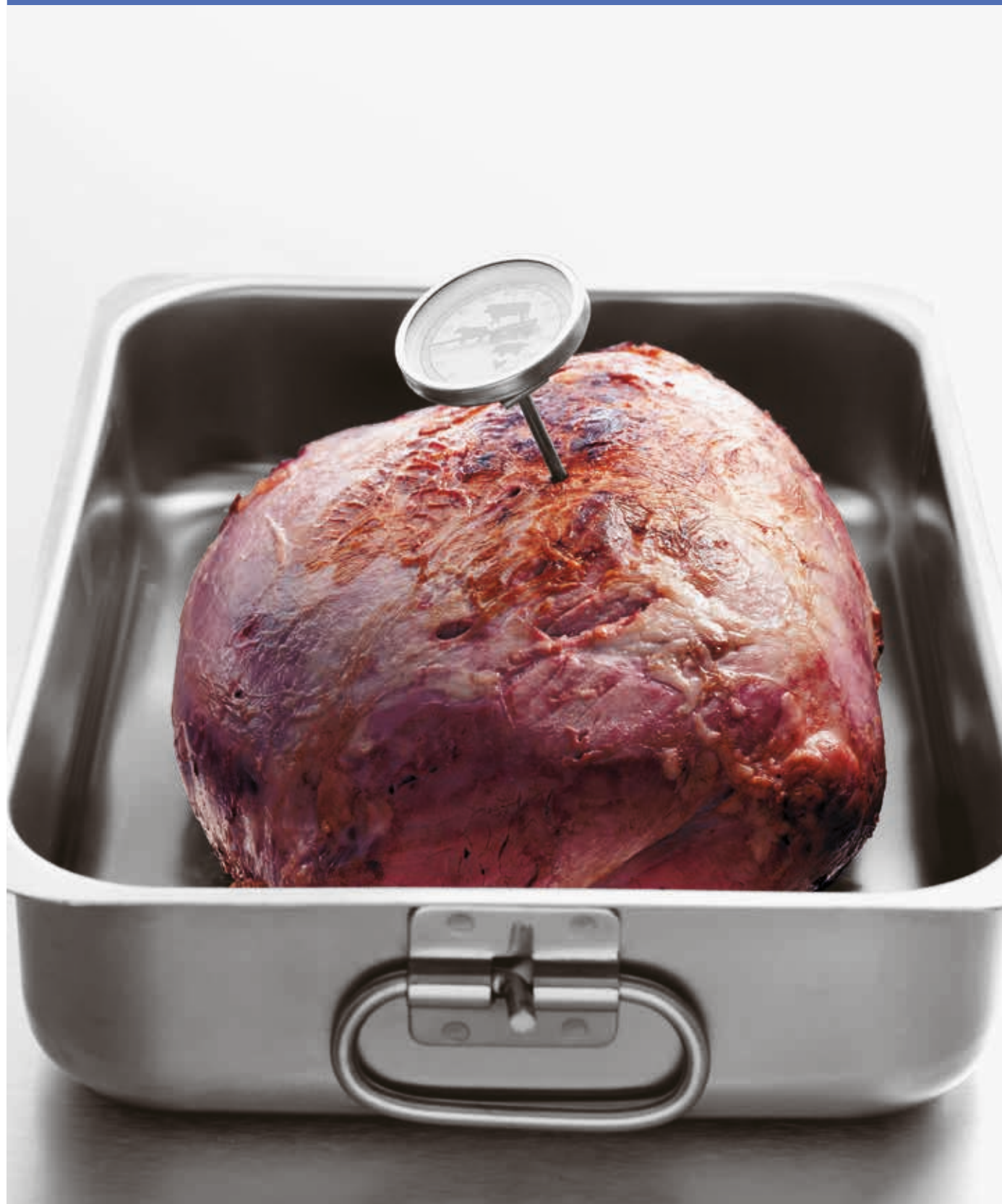



Roasting pan

Tegame
Bräter
Plaque à rôtir
Rustidera

| art. | cm. | h. cm. | € |
|----------|-------|--------|--------|
| 11941-35 | 35x25 | 8 | 91,96 |
| 11941-40 | 40x26 | 9 | 131,25 |
| 11941-45 | 45x30 | 9 | 143,41 |
| 11941-50 | 50x30 | 9 | 174,77 |
| 11941-60 | 60x35 | 9 | 218,59 |



Heavy roasting pan

Tegame pesante
Bräter, Schwerausführung
Plaque à rôtir lourde
Rustidera pesada

| art. | cm. | h. cm. | € |
|-----------|-------|--------|--------|
| 11943-40 | 40x26 | 9 | 170,15 |
| 11943-45 | 45x30 | 9 | 190,85 |
| 11943-50 | 50x30 | 9 | 218,59 |
| 11943-60 | 60x35 | 9 | 253,26 |
| 11943-61* | 61x43 | 9 | 261,30 |

***For 2/1 GN ovens. – Per forno GN 2/1.**



Heavy roasting pan

Tegame pesante
Bräter, Schwerausführung
Plaque à rôtir lourde
Rustidera pesada

| art. | cm. | h. cm. | € |
|-----------|-------|--------|--------|
| 11944-40 | 40x26 | 9 | 170,15 |
| 11944-45 | 45x30 | 9 | 190,85 |
| 11944-50 | 50x30 | 9 | 228,94 |
| 11944-60 | 60x35 | 9 | 265,42 |
| 11944-61* | 61x43 | 9 | 273,66 |

***For 2/1 GN ovens. – Per forno GN 2/1.**



Lid

Coperchio
Deckel
Couvercle
Tapa

| art. | cm. | € |
|-----------|-------|--------|
| 11948-40 | 40x26 | 59,30 |
| 11948-45 | 45x30 | 73,16 |
| 11948-50 | 50x30 | 88,54 |
| 11948-60 | 60x35 | 105,42 |
| 11948-61* | 61x43 | 115,88 |

***For 2/1 GN ovens. – Per forno GN 2/1.**



Roasting pan with lid

Brasiera con coperchio
Brasiere mit Deckel
Braisière avec couvercle
Rustidera alta con tapa

| art. | cm. | h. cm. | € |
|-----------|-------|--------|--------|
| 11965-50 | 50x30 | 15 | 341,60 |
| 11965-60 | 60x35 | 15 | 427,02 |
| 11965-61* | 61x43 | 15 | 473,76 |

***For 2/1 GN ovens. – Per forno GN 2/1.**



Fry dripping tray, stainless steel

Colafrritto, inox
Pommes-Frites-Seiher, Edelstahl Rostfrei
Egouttoir à friture, inox
Escurridor para fritura, inox

| art. | Ø cm. | h. cm. | € |
|----------|-------|--------|-------|
| 41930-39 | 41 | 14 | 95,07 |

Detachable drip tray.

Vassoio raccogli liquidi removibile.



**INDUCTION
READY!**

Fish kettle

Pesciera
Fischkochkessel
Poissonnière
Hervidor pescado

| art. | cm. | h. cm. | € |
|----------|-----------|--------|-------|
| 41964-45 | 46x15,5 | 10,5 | 68,04 |
| 41964-60 | 61,5x18,5 | 11,0 | 97,49 |

Equipped with grid and cover.

Fornita con griglia e coperchio.





Whistling kettle
Bollitore
Kocher
Bouilloire à sifflet
Pava

| art. | Ø cm. | h. cm. | lt. | € |
|----------|-------|--------|-----|-------|
| 41914-03 | 20 | 18 | 2,8 | 42,41 |



Canister
Contentitore cilindrico
Behälter
Bahut
Contenedor cilíndrico

| art. | Ø cm. | h. cm. | lt. | € |
|----------|-------|--------|------|-------|
| 11913-16 | 16 | 12 | 2,4 | 51,56 |
| 11913-20 | 20 | 16 | 5,0 | 62,21 |
| 11913-24 | 24 | 20 | 9,0 | 76,48 |
| 11913-28 | 28 | 24 | 14,5 | 96,48 |



Bain-marie pot
Casseruola bagnomaria
Wasserbadkasserolle
Casserole bain-marie
Baño maria

| art. | Ø cm. | h. cm. | lt. | € |
|----------|-------|--------|-----|-------|
| 11910-12 | 12 | 14 | 1,4 | 46,13 |
| 11910-14 | 14 | 16 | 2,5 | 53,27 |
| 11910-16 | 16 | 18 | 3,6 | 60,30 |
| 11910-18 | 18 | 20 | 5,0 | 66,53 |
| 11910-20 | 20 | 22 | 7,0 | 77,28 |



Bain-marie pot
Bagnomaria
Behälter
Casserole bain-marie
Baño maria

| art. | Ø cm. | h. cm. | lt. | € |
|----------|-------|--------|-----|-------|
| 11911-12 | 12 | 14 | 1,4 | 47,74 |
| 11911-14 | 14 | 16 | 2,5 | 54,07 |
| 11911-16 | 16 | 18 | 3,6 | 61,31 |
| 11911-18 | 18 | 20 | 5,0 | 67,84 |
| 11911-20 | 20 | 22 | 7,0 | 77,79 |



Bain-marie, stackable
Bagno-maria impilabili
Bain-Marie, stapelbar
Bain-marie, empilables
Baño maria, apilable

| art. | cm. | h. cm. | lt. | € |
|----------|-------|--------|------|--------|
| 44501-01 | 24x24 | 23,5 | 13,0 | 259,59 |
| 44501-02 | 24x24 | 16,0 | 9,0 | 202,21 |
| 44501-03 | 24x24 | 7,5 | 4,0 | 145,93 |



Bain-marie, stackable
Bagno-maria impilabili
Bain-Marie, stapelbar
Bain-marie, empilables
Baño maria, apilable

| art. | cm. | h. cm. | lt. | € |
|----------|-----------|--------|-----|--------|
| 44502-01 | 15,5x15,5 | 23,5 | 5,0 | 169,85 |
| 44502-02 | 15,5x15,5 | 16,0 | 3,5 | 146,43 |
| 44502-03 | 15,5x15,5 | 7,5 | 1,5 | 108,54 |



Bain-marie, stackable
Bagno-maria impilabili
Bain-Marie, stapelbar
Bain-marie, empilables
Baño maria, apilable

| art. | cm. | h. cm. | lt. | € |
|----------|-----------|--------|-----|--------|
| 44503-01 | 15,5x10,5 | 16,0 | 2,5 | 122,01 |
| 44503-02 | 15,5x10,5 | 7,5 | 1,0 | 93,26 |
| 44503-03 | 15,5x10,5 | 5,5 | 0,5 | 89,55 |



Bain-marie lid
Coperchio bagnomaria
Wasserbadkasserolle-Deckel
Couverture pour bain-marie
Tapa para baño maria

| art. | cm. | € |
|----------|-----------|-------|
| 44501-04 | 24x24 | 48,44 |
| 44502-04 | 15,5x15,5 | 38,09 |
| 44503-04 | 15,5x10,5 | 34,67 |



1/4-Segment colander
Colapasta 1/4
1/4 Seiber-Einsatz
Passoire cuit-pâtes, 1/4
Colador 1/4

| art. | Ø cm. | h. cm. | lt. | € |
|----------|-------|--------|-----|-------|
| 11922-36 | 36 | 23 | 5,5 | 54,97 |
| 11922-40 | 40 | 26 | 7,5 | 67,13 |

For items/Per art.:
11007-11107-12007-12107-16929.

OVEN COOKING DISHES PIROFILE FORNO

PORCELAIN
PORCELLANA



Only use in the oven or microwave oven, do not place on direct flame.

Per uso in forni tradizionali e microonde, non mettere le porcellane a diretto contatto con la fiamma.



Oval dish, fluted

Pirofila ovale cordonata
Schale, oval, gerippt
Plat ovale, cannelé
Fuente oval borderizata

| art. | cm. | € |
|----------|-------------|-------|
| 44371-24 | 24x14x4 | 17,99 |
| 44371-28 | 28x16x4,5 | 23,52 |
| 44371-32 | 32,5x18x5 | 31,16 |
| 44371-36 | 36,5x19,5x5 | 39,20 |
| 44371-40 | 41x23x5,5 | 47,94 |
| 44371-44 | 44x26,5x5,7 | 64,12 |
| 44371-48 | 48x28,5x6,5 | 80,40 |



Round dish, fluted

Pirofila rotonda cordonata
Schale, rund, gerippt
Plat rond, cannelé
Fuente redonda borderizata

| art. | Ø cm. | € |
|----------|-------|--------|
| 44372-26 | 26,5 | 46,23 |
| 44372-32 | 32,0 | 57,89 |
| 44372-36 | 36,0 | 72,96 |
| 44372-40 | 40,0 | 119,80 |



Rectangular dish, fluted

Pirofila rettangolare cordonata
Schale, rechteckig, gerippt
Plat rectangulaire, cannelé
Fuente rectangular borderizata

| art. | cm. | € |
|----------|---------|--------|
| 44374-22 | 22x16x6 | 30,55 |
| 44374-25 | 25x20x7 | 36,78 |
| 44374-32 | 32x22x6 | 39,30 |
| 44374-36 | 36x24x6 | 48,94 |
| 44374-40 | 40x26x6 | 53,47 |
| 44374-44 | 44x32x6 | 108,84 |



Rectangular dish, low, fluted

Rettangolare cordonata, bassa
Schale, rechteckig, flach, gerippt
Plat rectangulaire, cannelé
Fuente rect. borderizata, baja

| art. | cm. | € |
|----------|---------|-------|
| 44376-40 | 40x30x4 | 65,12 |



Square dish, fluted

Pirofila quadra cordonata
Schale, quadratisch, gerippt
Plat carré, cannelé
Fuente cuadrada borderizata

| art. | cm. | € |
|----------|---------|-------|
| 44375-25 | 25x25x6 | 40,20 |



Soup bowl with cover

Casseruola con coperchio
Kasserolle mit Deckel
Casserole avec couvercle
Cacerola con tapa

| art. | cm. | lt. | € |
|----------|-------|-----|---|
| 44397-18 | 14x18 | 0,5 | - |



Escargot dish

Tegame lumache
Schneckenplatte
Plat à escargots
Plato caracoles

| art. | Ø cm. | € |
|----------|-------|-------|
| 44378-06 | 19 | 15,98 |



Egg dish, fluted

Tegamino cordonato
Schale, gerippt
Plat à oeufs, cannelé
Fuente huevo borderizata

| art. | cm. | € |
|----------|---------|-------|
| 44394-18 | 18x21,0 | 14,57 |
| 44394-21 | 21x24,5 | 21,41 |



Egg dish, high, fluted

Tegamino fondo, cordonato
Schale, tief, gerippt
Plat oeuf, creux, cannelé
Fuente soufflé borderizata, alta

| art. | cm. | € |
|----------|-------|-------|
| 44395-18 | 18x20 | 14,57 |



Creme broulée bowl

Coppetta creme broulée
Crème broulée Schale
Coupelle broulée à crème
Bol creme broulée

| art. | Ø cm. | h. cm. | € |
|----------|-------|--------|------|
| 44391-12 | 11,6 | 3 | 8,94 |



Ramekin, fluted

Soufflé cordonato
Ramekin, gerippt
Ramequin, cannelé
Fuente soufflé borderizata

| art. | Ø cm. | h. cm. | € |
|----------|-------|--------|-------|
| 44390-07 | 7 | 4,0 | 6,73 |
| 44390-09 | 9 | 4,5 | 7,74 |
| 44390-11 | 11 | 6,0 | 16,08 |



Ramekin, fluted

Soufflé cordonato
Ramekin, gerippt
Ramequin, cannelé
Fuente soufflé borderizata

| art. | Ø cm. | h. cm. | € |
|----------|-------|--------|-------|
| 44390-15 | 15 | 5,0 | 21,41 |
| 44390-18 | 18 | 7,5 | 26,93 |
| 44390-23 | 23 | 8,0 | 34,27 |

GN FOOD PANS CONTENITORI GN

STAINLESS STEEL, ALUMINUM, POLYCARBONATE, POLYPROPYLENE, MELAMINE AND PORCELAIN
INOX, ALLUMINIO, POLICARBONATO, POLIPROPILENE, MELAMINA E PORCELLANA

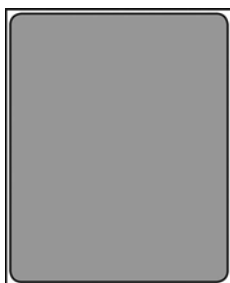

FOOD PANS, STAINLESS STEEL
BACINELLE GASTRONORM, INOX

GN-containers

 GN bacinelle
 GN-Behälter
 GN bacs
 GN cubetas



| art. | GN | dim. mm. | h. mm. | lt. | € |
|----------|-----|----------|--------|-----|--------|
| 14101-02 | 2/1 | 650x530 | 20 | - | 38,29 |
| 14101-04 | 2/1 | 650x530 | 40 | - | 42,51 |
| 14101-06 | 2/1 | 650x530 | 65 | 19 | 48,34 |
| 14101-10 | 2/1 | 650x530 | 100 | 31 | 58,89 |
| 14101-15 | 2/1 | 650x530 | 150 | 46 | 84,92 |
| 14101-20 | 2/1 | 650x530 | 200 | 56 | 101,40 |

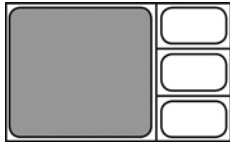

| art. | GN | dim. mm. | h. mm. | lt. | € |
|----------|-----|----------|--------|-----|-------|
| 14102-02 | 1/1 | 530x325 | 20 | - | 17,79 |
| 14102-04 | 1/1 | 530x325 | 40 | - | 20,90 |
| 14102-06 | 1/1 | 530x325 | 65 | 9 | 25,23 |
| 14102-10 | 1/1 | 530x325 | 100 | 14 | 29,45 |
| 14102-15 | 1/1 | 530x325 | 150 | 21 | 41,51 |
| 14102-20 | 1/1 | 530x325 | 200 | 28 | 50,35 |

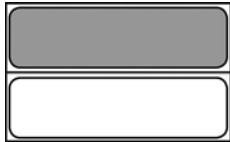

| art. | GN | dim. mm. | h. mm. | lt. | € |
|----------|-----|----------|--------|------|-------|
| 14103-02 | 2/3 | 353x320 | 20 | - | 12,36 |
| 14103-04 | 2/3 | 353x320 | 40 | - | 16,78 |
| 14103-06 | 2/3 | 353x320 | 65 | 5,5 | 18,89 |
| 14103-10 | 2/3 | 353x320 | 100 | 9,0 | 23,82 |
| 14103-15 | 2/3 | 353x320 | 150 | 13,0 | 30,85 |
| 14103-20 | 2/3 | 353x320 | 200 | 18,0 | 48,84 |



| art. | GN | dim. mm. | h. mm. | lt. | € |
|----------|-----|----------|--------|-----|-------|
| 14104-06 | 2/4 | 162x530 | 65 | 4,0 | 20,00 |
| 14104-10 | 2/4 | 162x530 | 100 | 5,6 | 24,32 |
| 14104-15 | 2/4 | 162x530 | 150 | 8,7 | 38,09 |



| art. | GN | dim. mm. | h. mm. | lt. | € |
|----------|-----|----------|--------|------|-------|
| 14105-02 | 1/2 | 325x265 | 20 | - | 10,55 |
| 14105-04 | 1/2 | 325x265 | 40 | - | 12,26 |
| 14105-06 | 1/2 | 325x265 | 65 | 4,0 | 15,28 |
| 14105-10 | 1/2 | 325x265 | 100 | 6,5 | 18,59 |
| 14105-15 | 1/2 | 325x265 | 150 | 9,5 | 24,42 |
| 14105-20 | 1/2 | 325x265 | 200 | 12,5 | 29,85 |

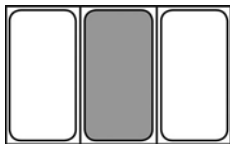

| art. | GN | dim. mm. | h. mm. | lt. | € |
|----------|-----|----------|--------|-----|-------|
| 14107-06 | 1/3 | 325x180 | 65 | 2,5 | 12,16 |
| 14107-10 | 1/3 | 325x180 | 100 | 4,0 | 14,07 |
| 14107-15 | 1/3 | 325x180 | 150 | 5,7 | 18,89 |
| 14107-20 | 1/3 | 325x180 | 200 | 7,8 | 24,32 |



| art. | GN | dim. mm. | h. mm. | lt. | € |
|----------|-----|----------|--------|-----|-------|
| 14108-06 | 1/4 | 265x160 | 65 | 1,8 | 10,35 |
| 14108-10 | 1/4 | 265x160 | 100 | 2,8 | 12,66 |
| 14108-15 | 1/4 | 265x160 | 150 | 4,0 | 15,68 |
| 14108-20 | 1/4 | 265x160 | 200 | 5,5 | 22,61 |



| art. | GN | dim. mm. | h. mm. | lt. | € |
|----------|-----|----------|--------|-----|-------|
| 14109-06 | 1/6 | 176x160 | 65 | 1,0 | 9,15 |
| 14109-10 | 1/6 | 176x160 | 100 | 1,6 | 10,35 |
| 14109-15 | 1/6 | 176x160 | 150 | 2,4 | 13,57 |
| 14109-20 | 1/6 | 176x160 | 200 | 3,4 | 25,33 |



| art. | GN | dim. mm. | h. mm. | lt. | € |
|----------|-----|----------|--------|-----|-------|
| 14110-06 | 1/9 | 176x110 | 65 | 0,6 | 9,45 |
| 14110-10 | 1/9 | 176x110 | 100 | 1,0 | 12,36 |



GN-containers, fixed handles

GN bacinelle, maniglie fisse

GN-Behälter mit festen Griffen

GN bacs, anses fixes

GN cubetas, asas fijas



| art. | GN | dim. mm. | h. mm. | lt. | € |
|----------|-----|----------|--------|------|-------|
| 14112-10 | 1/1 | 530x325 | 100 | 14,0 | 43,92 |
| 14112-15 | 1/1 | 530x325 | 150 | 21,0 | 61,20 |
| 14112-20 | 1/1 | 530x325 | 200 | 28,0 | 73,26 |



| art. | GN | dim. mm. | h. mm. | lt. | € |
|----------|-----|----------|--------|------|-------|
| 14115-10 | 1/2 | 325x265 | 100 | 6,5 | 29,25 |
| 14115-15 | 1/2 | 325x265 | 150 | 9,5 | 37,49 |
| 14115-20 | 1/2 | 325x265 | 200 | 12,5 | 44,82 |

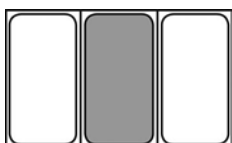

| art. | GN | dim. mm. | h. mm. | lt. | € |
|----------|-----|----------|--------|-----|-------|
| 14117-10 | 1/3 | 325x180 | 100 | 4,0 | 21,51 |
| 14117-15 | 1/3 | 325x180 | 150 | 5,7 | 29,45 |
| 14117-20 | 1/3 | 325x180 | 200 | 7,8 | 34,97 |



| art. | GN | dim. mm. | h. mm. | lt. | € |
|----------|-----|----------|--------|-----|-------|
| 14118-10 | 1/4 | 265x160 | 100 | 2,8 | 19,60 |
| 14118-15 | 1/4 | 265x160 | 150 | 4,0 | 25,02 |
| 14118-20 | 1/4 | 265x160 | 200 | 5,5 | 30,05 |



| art. | GN | dim. mm. | h. mm. | lt. | € |
|----------|-----|----------|--------|-----|-------|
| 14119-10 | 1/6 | 176x160 | 100 | 1,6 | 16,68 |
| 14119-15 | 1/6 | 176x160 | 150 | 2,4 | 21,61 |



| art. | GN | dim. mm. | h. mm. | lt. | € |
|----------|-----|----------|--------|------|---|
| 14142-20 | 1/1 | 530x325 | 200 | 28,0 | - |



| art. | GN | dim. mm. | h. mm. | lt. | € |
|----------|-----|----------|--------|------|---|
| 14145-10 | 1/2 | 325x265 | 100 | 6,5 | - |
| 14145-15 | 1/2 | 325x265 | 150 | 9,5 | - |
| 14145-20 | 1/2 | 325x265 | 200 | 12,5 | - |

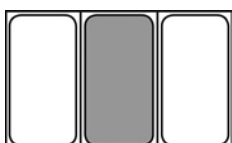

| art. | GN | dim. mm. | h. mm. | lt. | € |
|----------|-----|----------|--------|-----|---|
| 14147-15 | 1/3 | 325x180 | 150 | 5,7 | - |
| 14147-20 | 1/3 | 325x180 | 200 | 7,8 | - |



| art. | GN | dim. mm. | h. mm. | lt. | € |
|----------|-----|----------|--------|-----|---|
| 14148-10 | 1/4 | 265x160 | 100 | 2,8 | - |
| 14148-15 | 1/4 | 265x160 | 150 | 4,0 | - |
| 14148-20 | 1/4 | 265x160 | 200 | 5,5 | - |

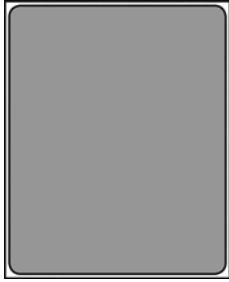

GN-containers, falling handles
GN bacinelle, maniglie rientranti
GN-Behälter mit versenkbaren Griffen
GN bacs, anses escamotables
GN cubetas, asas móviles



| art. | GN | dim. mm. | h. mm. | lt. | € |
|----------|-----|----------|--------|------|--------|
| 14151-10 | 2/1 | 650x530 | 100 | 31,0 | 81,71 |
| 14151-15 | 2/1 | 650x530 | 150 | 46,0 | 114,97 |
| 14151-20 | 2/1 | 650x530 | 200 | 56,0 | 124,42 |



| art. | GN | dim. mm. | h. mm. | lt. | € |
|----------|-----|----------|--------|------|-------|
| 14152-06 | 1/1 | 530x325 | 65 | 9,0 | 40,80 |
| 14152-10 | 1/1 | 530x325 | 100 | 14,0 | 46,33 |
| 14152-15 | 1/1 | 530x325 | 150 | 21,0 | 63,72 |
| 14152-20 | 1/1 | 530x325 | 200 | 28,0 | 75,88 |



| art. | GN | dim. mm. | h. mm. | lt. | € |
|----------|-----|----------|--------|------|-------|
| 14155-10 | 1/2 | 325x265 | 100 | 6,5 | 31,76 |
| 14155-15 | 1/2 | 325x265 | 150 | 9,5 | 40,10 |
| 14155-20 | 1/2 | 325x265 | 200 | 12,5 | 47,34 |

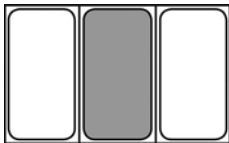

| art. | GN | dim. mm. | h. mm. | lt. | € |
|----------|-----|----------|--------|-----|-------|
| 14157-10 | 1/3 | 325x180 | 100 | 4,0 | 24,12 |
| 14157-15 | 1/3 | 325x180 | 150 | 5,7 | 31,96 |
| 14157-20 | 1/3 | 325x180 | 200 | 7,8 | 37,59 |



| art. | GN | dim. mm. | h. mm. | lt. | € |
|----------|-----|----------|--------|-----|-------|
| 14158-10 | 1/4 | 265x160 | 100 | 2,8 | 22,01 |
| 14158-15 | 1/4 | 265x160 | 150 | 4,0 | 27,54 |
| 14158-20 | 1/4 | 265x160 | 200 | 5,5 | 33,77 |



| art. | GN | dim. mm. | h. mm. | lt. | € |
|----------|-----|----------|--------|-----|-------|
| 14159-10 | 1/6 | 176x160 | 100 | 1,6 | 18,79 |
| 14159-15 | 1/6 | 176x160 | 150 | 2,4 | 23,12 |
| 14159-20 | 1/6 | 176x160 | 200 | 3,4 | 38,09 |



GN-containers non stick coated
GN bacinelle antiaderenti
GN-Behälter mit Antihafbeschichtung
GN-bacs avec revêtement anti-adhésif
GN-cubetas con cobertura antiadherente



| art. | GN | dim. mm. | h. mm. | € |
|----------|-----|----------|--------|-------|
| 14162-02 | 1/1 | 530x325 | 20 | 79,09 |
| 14162-04 | 1/1 | 530x325 | 40 | 86,03 |
| 14162-06 | 1/1 | 530x325 | 65 | 95,88 |



| art. | GN | dim. mm. | h. mm. | € |
|----------|-----|----------|--------|-------|
| 14165-02 | 1/2 | 325x265 | 20 | 57,39 |
| 14165-04 | 1/2 | 325x265 | 40 | 61,41 |
| 14165-06 | 1/2 | 325x265 | 65 | 68,94 |

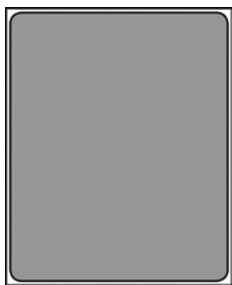

Perforated GN-containers

GN bacinelle forate
Gelochte GN-Behälter
GN bacs perforés
GN cubetas perforados



| art. | GN | dim. mm. | h. mm. | € |
|----------|-----|----------|--------|--------|
| 14201-02 | 2/1 | 650x530 | 20 | 59,19 |
| 14201-04 | 2/1 | 650x530 | 40 | 65,33 |
| 14201-06 | 2/1 | 650x530 | 65 | 68,34 |
| 14201-10 | 2/1 | 650x530 | 100 | 91,56 |
| 14201-15 | 2/1 | 650x530 | 150 | 138,09 |
| 14201-20 | 2/1 | 650x530 | 200 | 156,18 |

Containers depth mm 20 and 40 only bottom perforated. – Bacinelle profondità mm 20 e 40 forate solo sul fondo.



| art. | GN | dim. mm. | h. mm. | € |
|----------|-----|----------|--------|-------|
| 14202-02 | 1/1 | 530x325 | 20 | 24,22 |
| 14202-04 | 1/1 | 530x325 | 40 | 27,94 |
| 14202-06 | 1/1 | 530x325 | 65 | 35,18 |
| 14202-10 | 1/1 | 530x325 | 100 | 43,72 |
| 14202-15 | 1/1 | 530x325 | 150 | 58,19 |
| 14202-20 | 1/1 | 530x325 | 200 | 69,85 |

Containers depth mm 20 and 40 only bottom perforated. – Bacinelle profondità mm 20 e 40 forate solo sul fondo.



| art. | GN | dim. mm. | h. mm. | € |
|----------|-----|----------|--------|-------|
| 14203-06 | 2/3 | 353x320 | 65 | 26,63 |
| 14203-10 | 2/3 | 353x320 | 100 | 35,58 |
| 14203-15 | 2/3 | 353x320 | 150 | 50,35 |
| 14203-20 | 2/3 | 353x320 | 200 | 61,31 |

Containers depth mm 20 and 40 only bottom perforated. – Bacinelle profondità mm 20 e 40 forate solo sul fondo.



| art. | GN | dim. mm. | h. mm. | € |
|----------|-----|----------|--------|-------|
| 14205-02 | 1/2 | 325x265 | 20 | 17,09 |
| 14205-04 | 1/2 | 325x265 | 40 | 15,98 |
| 14205-06 | 1/2 | 325x265 | 65 | 20,10 |
| 14205-10 | 1/2 | 325x265 | 100 | 25,33 |
| 14205-15 | 1/2 | 325x265 | 150 | 35,38 |
| 14205-20 | 1/2 | 325x265 | 200 | 53,87 |

Containers depth mm 20 and 40 only bottom perforated. – Bacinelle profondità mm 20 e 40 forate solo sul fondo.



Perforated GN-containers, folding handles

GN bacinelle forate, maniglie snodate
Gelochte GN-Behälter mit Fallgriffen
GN bacs perforés, anses pliantes
GN cubetas perforados, asas plegables



| art. | GN | dim. mm. | h. mm. | € |
|----------|-----|----------|--------|-------|
| 14252-06 | 1/1 | 530x325 | 65 | 44,72 |
| 14252-10 | 1/1 | 530x325 | 100 | 53,87 |
| 14252-15 | 1/1 | 530x325 | 150 | 80,30 |
| 14252-20 | 1/1 | 530x325 | 200 | 97,18 |



| art. | GN | dim. mm. | h. mm. | € |
|----------|-----|----------|--------|---|
| 14255-06 | 1/2 | 325x265 | 65 | - |
| 14255-10 | 1/2 | 325x265 | 100 | - |
| 14255-15 | 1/2 | 325x265 | 150 | - |
| 14255-20 | 1/2 | 325x265 | 200 | - |



GN-lids
GN coperchi
GN-Deckel
GN couvercles
GN tapas

| art. | GN | dim. mm. | € |
|----------|-----|----------|-------|
| 14502-00 | 1/1 | 530x325 | 17,49 |
| 14503-00 | 2/3 | 353x320 | 13,37 |
| 14504-00 | 2/4 | 162x530 | 12,86 |
| 14505-00 | 1/2 | 325x265 | 9,55 |
| 14507-00 | 1/3 | 325x180 | 7,74 |
| 14508-00 | 1/4 | 265x160 | 6,23 |
| 14509-00 | 1/6 | 176x160 | 5,73 |
| 14510-00 | 1/9 | 176x110 | 4,72 |



GN-lids with notched edge for handles
GN coperchi con spacco maniglie
GN-Deckel mit Griffen-Ausschnitt
GN couvercles avec encoche pour anses
GN tapas con orificio asas

| art. | GN | dim. mm. | € |
|----------|-----|----------|-------|
| 14512-00 | 1/1 | 530x325 | 25,33 |
| 14515-00 | 1/2 | 325x265 | 15,28 |
| 14517-00 | 1/3 | 325x180 | 11,66 |
| 14518-00 | 1/4 | 265x160 | 10,35 |
| 14519-00 | 1/6 | 176x160 | 8,44 |



GN-lids with notched edge for ladle
GN coperchi con spacco mestolo
GN-Deckel mit Löffel-Ausschnitt
GN couvercles avec encoche pour louche
GN tapas con orificio cacillo

| art. | GN | dim. mm. | € |
|----------|-----|----------|-------|
| 14522-00 | 1/1 | 530x325 | 24,22 |
| 14523-00 | 2/3 | 353x320 | 18,29 |
| 14525-00 | 1/2 | 325x265 | 14,17 |
| 14527-00 | 1/3 | 325x180 | 10,55 |
| 14528-00 | 1/4 | 265x160 | 9,25 |
| 14529-00 | 1/6 | 176x160 | 7,44 |



GN-lids with notched edge for handles/ladle
GN coperchi con spacco maniglie/mestolo
GN-Deckel mit Griffen u. Löffel-Ausschnitt
GN couvercles avec encoche pour anses/louche
GN tapas con orificio asas/cacillo

| art. | GN | dim. mm. | € |
|----------|-----|----------|-------|
| 14532-00 | 1/1 | 530x325 | 26,43 |
| 14535-00 | 1/2 | 325x265 | 16,38 |
| 14537-00 | 1/3 | 325x180 | 12,86 |
| 14538-00 | 1/4 | 265x160 | 12,66 |
| 14539-00 | 1/6 | 176x160 | 9,65 |



GN-lids with silicone seal
GN coperchi con guarnizione silicone
GN-Deckel mit Silikondichtung
GN couvercles avec joint silicone
GN tapas con junta de silicona

| art. | GN | dim. mm. | € |
|----------|-----|----------|-------|
| 14542-00 | 1/1 | 530x325 | 46,93 |
| 14543-00 | 2/3 | 353x320 | 44,82 |
| 14545-00 | 1/2 | 325x265 | 32,66 |
| 14547-00 | 1/3 | 325x180 | 27,54 |
| 14548-00 | 1/4 | 265x160 | 25,02 |
| 14549-00 | 1/6 | 176x160 | 23,12 |





GN-lids with notched edge for handles and seal
GN coperchi con spacco maniglie e guarnizione
GN-Deckel mit Griffen-Ausschnitt u. Silikondichtung
GN couvercles avec encoche pour anses et joint
GN tapas con orificio asas y junta

| art. | GN | dim. mm. | € |
|----------|-----|----------|-------|
| 14552-00 | 1/1 | 530x325 | 89,14 |
| 14555-00 | 1/2 | 325x265 | - |

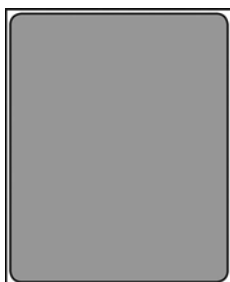

GN-baking sheets
GN-teglie
GN-Backbleche
GN-plaques
GN-bandejas

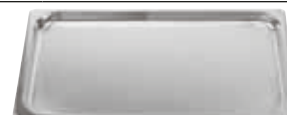

| art. | GN | dim. mm. | h. mm. | € |
|----------|-----|----------|--------|-------|
| 14301-02 | 2/1 | 650x530 | 20 | 38,19 |
| 14301-04 | 2/1 | 650x530 | 40 | 42,91 |
| 14301-06 | 2/1 | 650x530 | 65 | 48,44 |



| art. | GN | dim. mm. | h. mm. | € |
|----------|-----|----------|--------|-------|
| 14302-02 | 1/1 | 530x325 | 20 | 17,79 |
| 14302-04 | 1/1 | 530x325 | 40 | 20,90 |
| 14302-06 | 1/1 | 530x325 | 65 | 25,23 |



| art. | GN | dim. mm. | h. mm. | € |
|----------|-----|----------|--------|-------|
| 14303-02 | 2/3 | 353x320 | 20 | 12,46 |
| 14303-04 | 2/3 | 353x320 | 40 | 22,91 |
| 14303-06 | 2/3 | 353x320 | 65 | 26,13 |



| art. | GN | dim. mm. | h. mm. | € |
|----------|-----|----------|--------|-------|
| 14305-02 | 1/2 | 325x265 | 20 | 10,65 |
| 14305-04 | 1/2 | 325x265 | 40 | 12,26 |
| 14305-06 | 1/2 | 325x265 | 65 | 15,38 |



GN-baking sheets non stick coated
GN-teglie con rivestimento antiaderente
GN-Backbleche mit Antihafbeschichtung
GN-plaques avec revêtement anti-adhésif
GN-bandejas con cobertura antiadherente



| art. | GN | dim. mm. | h. mm. | € |
|----------|-----|----------|--------|-------|
| 14362-02 | 1/1 | 530x325 | 20 | 36,68 |
| 14362-04 | 1/1 | 530x325 | 40 | 41,10 |
| 14362-06 | 1/1 | 530x325 | 65 | 45,73 |



| art. | GN | dim. mm. | h. mm. | € |
|----------|-----|----------|--------|-------|
| 14365-02 | 1/2 | 325x265 | 20 | 24,02 |
| 14365-04 | 1/2 | 325x265 | 40 | 25,63 |
| 14365-06 | 1/2 | 325x265 | 65 | 30,05 |



GN-baking sheets, ALUMINUM

GN-teglie, ALLUMINIO
GN-Backbleche, ALUMINIUM
GN-plaques, ALUMINIUM
GN-bandejas, ALUMINIO



| art. | GN | dim. mm. | h. mm. | € |
|----------|-----|----------|--------|---|
| 16302-02 | 1/1 | 530x325 | 20 | - |
| 16302-04 | 1/1 | 530x325 | 40 | - |
| 16302-06 | 1/1 | 530x325 | 65 | - |

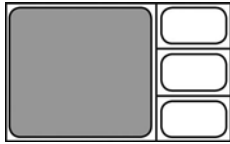

| art. | GN | dim. mm. | h. mm. | € |
|----------|-----|----------|--------|-------|
| 16303-02 | 2/3 | 353x320 | 20 | 15,48 |
| 16303-04 | 2/3 | 353x320 | 40 | 22,21 |
| 16303-06 | 2/3 | 353x320 | 65 | 24,52 |



| art. | GN | dim. mm. | h. mm. | € |
|----------|-----|----------|--------|-------|
| 16305-02 | 1/2 | 325x265 | 20 | 13,77 |
| 16305-04 | 1/2 | 325x265 | 40 | 17,99 |
| 16305-06 | 1/2 | 325x265 | 65 | 20,90 |



GN-baking sheets, ALUMINUM non stick coated

GN-teglie, ALLUMINIO antiaderente
GN-Backbleche, ALUMINIUM mit Antihafbeschichtung
GN-plaques, ALUMINIUM avec revêtement anti-adhésif
GN-bandejas, ALUMINIO con cobertura antiaderente



| art. | GN | dim. mm. | h. mm. | € |
|----------|-----|----------|--------|---|
| 16362-02 | 1/1 | 530x325 | 20 | - |
| 16362-04 | 1/1 | 530x325 | 40 | - |
| 16362-06 | 1/1 | 530x325 | 65 | - |

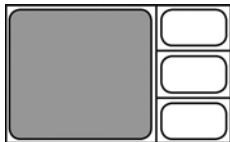

| art. | GN | dim. mm. | h. mm. | € |
|----------|-----|----------|--------|-------|
| 16363-02 | 2/3 | 353x320 | 20 | - |
| 16363-04 | 2/3 | 353x320 | 40 | 27,14 |
| 16363-06 | 2/3 | 353x320 | 65 | 30,75 |



| art. | GN | dim. mm. | h. mm. | € |
|----------|-----|----------|--------|-------|
| 16365-02 | 1/2 | 325x265 | 20 | 21,51 |
| 16365-04 | 1/2 | 325x265 | 40 | 22,61 |
| 16365-06 | 1/2 | 325x265 | 65 | 26,23 |





Drainer plate
Falso fondo forato
Abtropfplatte
Plateau double fond perforé
Fondo perforado

| art. | GN | € |
|----------|-----|-------|
| 14402-00 | 1/1 | 24,52 |
| 14405-00 | 1/2 | 13,37 |
| 14407-00 | 1/3 | 9,95 |



Adaptor bar
Separatore
StegeAdapter/Zwischensteg
Barrette de composition
Adaptador

| art. | GN | dim. mm. | € |
|----------|-----|----------|------|
| 14409-01 | 1/1 | 325 | 4,52 |
| 14409-02 | 2/1 | 530 | 6,03 |

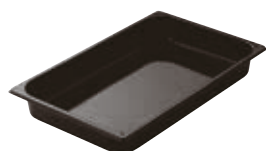

Pan, enameled
Teglia smaltata
Ofenblech, emalliert
Bac émaillé
Cubeta esmaltada

| art. | GN | dim. mm. | h. mm. | lt. | € |
|----------|-----|----------|--------|-----|-------|
| 44322-02 | 1/1 | 530x325 | 20 | 2,5 | 24,72 |
| 44322-04 | 1/1 | 530x325 | 40 | 5,0 | 26,43 |
| 44322-06 | 1/1 | 530x325 | 65 | 9,0 | 30,35 |

Not stackable. – Non impilabili.

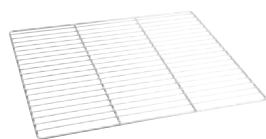

Wire grid
Griglia in filo
Gastronormrost
Grille
Rejilla

| art. | GN | dim. mm. | € |
|----------|-----|----------|-------|
| 44412-00 | 1/2 | 325x265 | 19,80 |
| 44423-00 | 2/3 | 353x320 | 24,62 |
| 44421-00 | 2/1 | 650x530 | 43,22 |



Wire grid
Griglia in filo
Gastronormrost
Grille
Rejilla

| art. | GN | dim. mm. | € |
|----------|-----|----------|-------|
| 44422-00 | 1/1 | 530x325 | 25,63 |

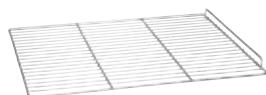

Wire grid with edge
Griglia in filo con sponda
Gastronormrost mit Seitenwand
Grille avec arrêt
Rejilla con borde

| art. | GN | dim. mm. | € |
|----------|-----|----------|-------|
| 44432-21 | 2/1 | 650x530 | 52,46 |



Grid enameled
Griglia smaltata
Rost, emalliert
Grille émaillé
Rejilla esmaltada

| art. | GN | dim. mm. | € |
|----------|-----|----------|--------|
| 11760-11 | 1/1 | 530x325 | 112,46 |

POLYCARBONATE POLICARBONATO

GN FOOD PANS
CONTENITORI GN

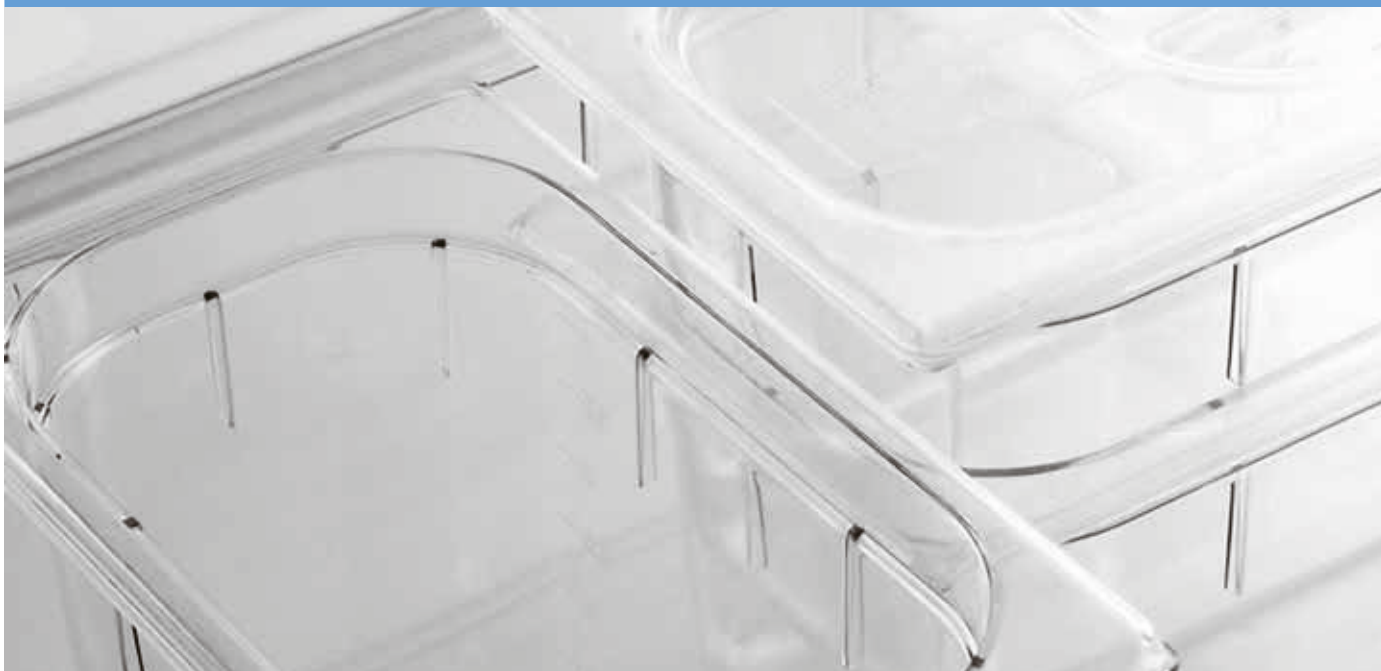

Withstands temperatures from **-40°C to + 100°C**. With metric graduation.
Stackable, ideal for storage, transportation and serving display.

Termoresistenti da **-40°C a +100°C**. Con scala graduata in litri. Impilabili, sono ideali per la conservazione, trasporto ed esposizione.

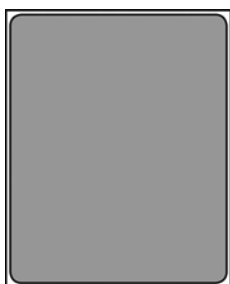

GN-containers

GN bacinelle
GN-Behälter
GN bacs
GN cubetas

| art. | GN | dim. mm. | h. mm. | lt. | € |
|----------|-----|----------|--------|-----|-------|
| 14561-15 | 2/1 | 650x530 | 150 | 42 | 85,02 |
| 14561-20 | 2/1 | 650x530 | 200 | 52 | 88,74 |



| art. | GN | dim. mm. | h. mm. | lt. | € |
|----------|-----|----------|--------|------|-------|
| 14562-06 | 1/1 | 530x325 | 65 | 8,5 | 14,17 |
| 14562-10 | 1/1 | 530x325 | 100 | 13,0 | 17,59 |
| 14562-15 | 1/1 | 530x325 | 150 | 19,5 | 21,91 |
| 14562-20 | 1/1 | 530x325 | 200 | 26,0 | 26,03 |



| art. | GN | dim. mm. | h. mm. | lt. | € |
|----------|-----|----------|--------|------|-------|
| 14565-06 | 1/2 | 325x265 | 65 | 3,9 | 8,14 |
| 14565-10 | 1/2 | 325x265 | 100 | 5,9 | 10,35 |
| 14565-15 | 1/2 | 325x265 | 150 | 8,9 | 13,07 |
| 14565-20 | 1/2 | 325x265 | 200 | 11,8 | 16,18 |

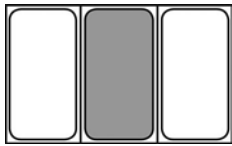

| art. | GN | dim. mm. | h. mm. | lt. | € |
|----------|-----|----------|--------|-----|-------|
| 14567-06 | 1/3 | 325x180 | 65 | 2,4 | 7,04 |
| 14567-10 | 1/3 | 325x180 | 100 | 3,6 | 8,24 |
| 14567-15 | 1/3 | 325x180 | 150 | 5,3 | 10,35 |
| 14567-20 | 1/3 | 325x180 | 200 | 7,0 | 12,86 |



| art. | GN | dim. mm. | h. mm. | lt. | € |
|----------|-----|----------|--------|-----|-------|
| 14568-06 | 1/4 | 265x160 | 65 | 1,7 | 5,53 |
| 14568-10 | 1/4 | 265x160 | 100 | 2,5 | 6,73 |
| 14568-15 | 1/4 | 265x160 | 150 | 3,7 | 8,84 |
| 14568-20 | 1/4 | 265x160 | 200 | 5,5 | 11,76 |



| art. | GN | dim. mm. | h. mm. | lt. | € |
|----------|-----|----------|--------|-----|------|
| 14569-06 | 1/6 | 176x160 | 65 | 1,0 | 4,42 |
| 14569-10 | 1/6 | 176x160 | 100 | 1,5 | 4,82 |
| 14569-15 | 1/6 | 176x160 | 150 | 2,2 | 6,53 |
| 14569-20 | 1/6 | 176x160 | 200 | 3,4 | 7,44 |



| art. | GN | dim. mm. | h. mm. | lt. | € |
|----------|-----|----------|--------|-----|------|
| 14570-06 | 1/9 | 176x110 | 65 | 0,6 | 3,62 |
| 14570-10 | 1/9 | 176x110 | 100 | 1,0 | 3,92 |



GN-lid without handle
GN coperchio senza traversino
GN-Deckel ohne Griff
GN couvercle sans poignée
GN tapa sin asa

| art. | GN | dim. mm. | € |
|----------|-----|----------|-------|
| 14571-00 | 2/1 | 650x530 | 50,45 |



GN-lids with handle
GN coperchi con traversino
GN-Deckel mit Griff
GN couvercles avec poignée
GN tapas con asa

| art. | GN | dim. mm. | € |
|----------|-----|----------|-------|
| 14572-00 | 1/1 | 530x325 | 11,46 |
| 14575-00 | 1/2 | 325x265 | 6,53 |
| 14577-00 | 1/3 | 325x180 | 4,82 |
| 14578-00 | 1/4 | 265x160 | 3,72 |
| 14579-00 | 1/6 | 176x160 | 2,71 |
| 14580-00 | 1/9 | 176x110 | 2,51 |



GN-lid with silicone seal
GN coperchio con guarnizione silicone
GN-Deckel mit Silikondichtung
GN couvercle avec joint silicone
GN tapa con junta de silicona

| art. | GN | dim. mm. | € |
|----------|-----|----------|-------|
| 14585-00 | 1/2 | 325x265 | 13,77 |



Drainer plate
Falso fondo forato
Abtropfplatte
Plateau double fond perforé
Fondo perforado

| art. | GN | dim. mm. | € |
|----------|-----|----------|-------|
| 14591-00 | 2/1 | 650x530 | 42,11 |
| 14592-00 | 1/1 | 530x325 | 8,24 |
| 14595-00 | 1/2 | 325x265 | 4,32 |
| 14597-00 | 1/3 | 325x180 | 3,02 |
| 14598-00 | 1/4 | 265x160 | 2,61 |
| 14599-00 | 1/6 | 176x160 | 2,51 |

TRITAN BPA FREE

GN FOOD PANS
CONTENITORI GN



TRITAN - COPOLYMER - BPA FREE -40°C+90°C.

Can be used in microwave ovens but not for prolonged times. The lids of the series 14800 polycarbonate and 14600 Tritan are interchangeable.

Hermetic lids, NOT water-tight.

TRITAN COPOLIMERO - BPA FREE -40°C+90°C.

Utilizzabili nel microonde ma non per tempi prolungati. I coperchi della serie 14800 policarbonato e 14600 Tritan sono intercambiabili.

Coperchi ermetici, NON a tenuta stagna.

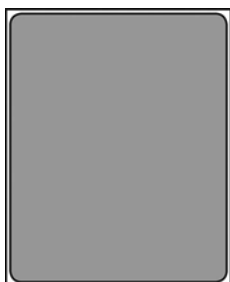

GN-containers

GN bacinelle
GN-Behälter
GN bacs
GN cubetas

| art. | GN | dim. mm. | h. mm. | lt. | € |
|----------|-----|----------|--------|------|--------|
| 14661-20 | 2/1 | 650x530 | 200 | 55,5 | 104,62 |



| art. | GN | dim. mm. | h. mm. | lt. | € |
|----------|-----|----------|--------|------|-------|
| 14662-06 | 1/1 | 530x325 | 65 | 9,0 | 33,87 |
| 14662-10 | 1/1 | 530x325 | 100 | 13,3 | 38,79 |
| 14662-15 | 1/1 | 530x325 | 150 | 20,0 | 47,54 |
| 14662-20 | 1/1 | 530x325 | 200 | 26,4 | 59,50 |



| art. | GN | dim. mm. | h. mm. | lt. | € |
|----------|-----|----------|--------|------|-------|
| 14665-06 | 1/2 | 325x265 | 65 | 4,0 | 17,09 |
| 14665-10 | 1/2 | 325x265 | 100 | 6,1 | 18,19 |
| 14665-15 | 1/2 | 325x265 | 150 | 9,0 | 24,22 |
| 14665-20 | 1/2 | 325x265 | 200 | 11,9 | 27,44 |

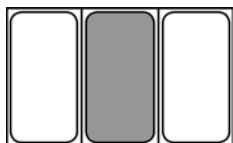

| art. | GN | dim. mm. | h. mm. | lt. | € |
|----------|-----|----------|--------|-----|-------|
| 14667-06 | 1/3 | 325x175 | 65 | 2,5 | 12,36 |
| 14667-10 | 1/3 | 325x175 | 100 | 3,8 | 14,57 |
| 14667-15 | 1/3 | 325x175 | 150 | 5,5 | 19,10 |
| 14667-20 | 1/3 | 325x175 | 200 | 7,1 | 22,81 |



| art. | GN | dim. mm. | h. mm. | lt. | € |
|----------|-----|----------|--------|-----|-------|
| 14668-06 | 1/4 | 264x162 | 65 | 1,7 | 9,55 |
| 14668-10 | 1/4 | 264x162 | 100 | 2,6 | 11,26 |
| 14668-15 | 1/4 | 264x162 | 150 | 3,8 | 15,28 |
| 14668-20 | 1/4 | 264x162 | 200 | 4,8 | 19,30 |



| art. | GN | dim. mm. | h. mm. | lt. | € |
|----------|-----|----------|--------|-----|-------|
| 14669-06 | 1/6 | 176x162 | 65 | 1,0 | 7,44 |
| 14669-10 | 1/6 | 176x162 | 100 | 1,6 | 8,94 |
| 14669-15 | 1/6 | 176x162 | 150 | 2,3 | 11,76 |
| 14669-20 | 1/6 | 176x162 | 200 | 2,8 | 13,27 |



| art. | GN | dim. mm. | h. mm. | lt. | € |
|----------|-----|----------|--------|-----|------|
| 14670-06 | 1/9 | 176x108 | 65 | 0,6 | 5,63 |
| 14670-10 | 1/9 | 176x108 | 100 | 0,9 | 6,83 |



GN-lids
GN-coperchi
GN-Deckel
GN couvercles
GN tapas

| art. | GN | dim. mm. | € |
|----------|-----|----------|-------|
| 14671-00 | 2/1 | 650x530 | 61,10 |
| 14672-00 | 1/1 | 530x325 | 23,12 |
| 14675-00 | 1/2 | 325x265 | 12,96 |
| 14677-00 | 1/3 | 325x175 | 8,74 |
| 14678-00 | 1/4 | 264x162 | 7,44 |
| 14679-00 | 1/6 | 176x162 | 5,93 |
| 14680-00 | 1/9 | 176x108 | 4,42 |

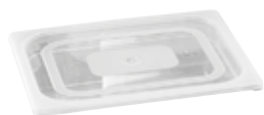

GN-lids, hermetic
GN coperchi ermetici
GN-Deckel, hermetisch
GN couvercles hermétiques
GN tapas herméticas

| art. | GN | dim. mm. | € |
|----------|-----|----------|-------|
| 14682-00 | 1/1 | 530x325 | 20,50 |
| 14685-00 | 1/2 | 325x265 | 10,95 |
| 14687-00 | 1/3 | 325x175 | 8,84 |
| 14688-00 | 1/4 | 264x162 | 7,14 |
| 14689-00 | 1/6 | 176x162 | 5,63 |
| 14690-00 | 1/9 | 176x108 | 4,02 |



Drainer plate
Falso fondo forato
Abtropfplatte
Plateau double fond perforé
Fondo perforado

| art. | GN | dim. mm. | € |
|----------|-----|----------|-------|
| 14691-00 | 2/1 | 650x530 | 35,68 |
| 14692-00 | 1/1 | 530x325 | 14,27 |
| 14695-00 | 1/2 | 325x265 | 7,64 |

POLYPROPYLENE POLIPROPILENE

GN FOOD PANS
CONTENITORI GN



Transparent and stackable. Dish-washer safe. Do not use abrasive sponges and substances. Recommended for use from -40°C to $+70^{\circ}\text{C}$. Graduation scale in liters. Lids tightly fitting.

Traslucide e impilabili. Lavabili in lavastoviglie con normali detersivi. Non utilizzare pagliette e sostanze abrasive. Consigliato l'utilizzo da -40°C a $+70^{\circ}\text{C}$. Scala di graduazione in litri. Coperchio resistente per una perfetta chiusura stagna.



GN-containers

GN bacinelle
GN-Behälter
GN bacs
GN cubetas

| art. | GN | dim. mm. | h. mm. | lt. | € |
|----------|-----|----------|--------|------|-------|
| 14702-06 | 1/1 | 530x325 | 65 | 8,5 | 8,24 |
| 14702-10 | 1/1 | 530x325 | 100 | 13,0 | 10,05 |
| 14702-15 | 1/1 | 530x325 | 150 | 19,5 | 12,96 |
| 14702-20 | 1/1 | 530x325 | 200 | 26,0 | 15,78 |



| art. | GN | dim. mm. | h. mm. | lt. | € |
|----------|-----|----------|--------|------|------|
| 14705-06 | 1/2 | 325x265 | 65 | 3,9 | 4,72 |
| 14705-10 | 1/2 | 325x265 | 100 | 5,9 | 6,13 |
| 14705-15 | 1/2 | 325x265 | 150 | 8,9 | 6,63 |
| 14705-20 | 1/2 | 325x265 | 200 | 11,8 | 7,14 |

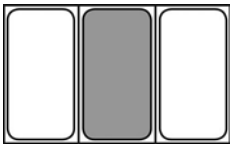

| art. | GN | dim. mm. | h. mm. | lt. | € |
|----------|-----|----------|--------|-----|------|
| 14707-06 | 1/3 | 325x180 | 65 | 2,4 | 4,22 |
| 14707-10 | 1/3 | 325x180 | 100 | 3,6 | 4,52 |
| 14707-15 | 1/3 | 325x180 | 150 | 5,3 | 5,03 |
| 14707-20 | 1/3 | 325x180 | 200 | 7,0 | 6,33 |



| art. | GN | dim. mm. | h. mm. | lt. | € |
|----------|-----|----------|--------|-----|------|
| 14708-06 | 1/4 | 265x160 | 65 | 1,7 | 3,42 |
| 14708-10 | 1/4 | 265x160 | 100 | 2,5 | 3,82 |
| 14708-15 | 1/4 | 265x160 | 150 | 3,7 | 4,52 |
| 14708-20 | 1/4 | 265x160 | 200 | 5,5 | 8,84 |



| art. | GN | dim. mm. | h. mm. | lt. | € |
|----------|-----|----------|--------|-----|------|
| 14709-06 | 1/6 | 176x160 | 65 | 1,0 | 2,91 |
| 14709-10 | 1/6 | 176x160 | 100 | 1,5 | 3,02 |
| 14709-15 | 1/6 | 176x160 | 150 | 2,2 | 3,42 |
| 14709-20 | 1/6 | 176x160 | 200 | 3,4 | 6,23 |



| art. | GN | dim. mm. | h. mm. | lt. | € |
|----------|-----|----------|--------|-----|------|
| 14710-06 | 1/9 | 176x110 | 65 | 1,3 | 2,61 |
| 14710-10 | 1/9 | 176x110 | 100 | 0,8 | 2,71 |



Drainer plate

Falso fondo forato
Abtropfplatte
Plateau double fond perforé
Fondo perforado

| art. | GN | dim. mm. | h. mm. | € |
|----------|-----|----------|--------|------|
| 14712-00 | 1/1 | 471x266 | 16 | 4,52 |
| 14715-00 | 1/2 | 266x206 | 16 | 2,81 |
| 14717-00 | 1/3 | 266x117 | 16 | 2,61 |
| 14718-00 | 1/4 | 207x103 | 16 | 2,11 |
| 14719-00 | 1/6 | 117x103 | 16 | 2,11 |





GN-lids
GN-coperchi
GN-Deckel
GN couvercles
GN tapas

| art. | GN | dim. mm. | col. | € |
|----------|-----|----------|------|------|
| 14722-00 | 1/1 | 530x325 | ● | 4,82 |
| 14722-11 | 1/1 | 530x325 | ● | 4,82 |
| 14722-22 | 1/1 | 530x325 | ● | 4,82 |
| 14722-33 | 1/1 | 530x325 | ● | 4,82 |
| 14722-99 | 1/1 | 530x325 | ○ | 4,82 |



| art. | GN | dim. mm. | col. | € |
|----------|-----|----------|------|------|
| 14725-00 | 1/2 | 325x265 | ● | 3,02 |
| 14725-11 | 1/2 | 325x265 | ● | 3,02 |
| 14725-22 | 1/2 | 325x265 | ● | 3,02 |
| 14725-33 | 1/2 | 325x265 | ● | 3,02 |
| 14725-99 | 1/2 | 325x265 | ○ | 3,02 |



| art. | GN | dim. mm. | col. | € |
|----------|-----|----------|------|------|
| 14727-00 | 1/3 | 325x180 | ● | 2,71 |
| 14727-11 | 1/3 | 325x180 | ● | 2,71 |
| 14727-22 | 1/3 | 325x180 | ● | 2,71 |
| 14727-33 | 1/3 | 325x180 | ● | 2,71 |
| 14727-99 | 1/3 | 325x180 | ○ | 2,71 |



| art. | GN | dim. mm. | col. | € |
|----------|-----|----------|------|------|
| 14728-00 | 1/4 | 265x160 | ● | 2,31 |
| 14728-11 | 1/4 | 265x160 | ● | 2,31 |
| 14728-22 | 1/4 | 265x160 | ● | 2,31 |
| 14728-33 | 1/4 | 265x160 | ● | 2,31 |
| 14728-99 | 1/4 | 265x160 | ○ | 2,31 |



| art. | GN | dim. mm. | col. | € |
|----------|-----|----------|------|------|
| 14729-00 | 1/6 | 176x160 | ● | 2,21 |
| 14729-11 | 1/6 | 176x160 | ● | 2,21 |
| 14729-22 | 1/6 | 176x160 | ● | 2,21 |
| 14729-33 | 1/6 | 176x160 | ● | 2,21 |
| 14729-99 | 1/6 | 176x160 | ○ | 2,21 |



| art. | GN | dim. mm. | col. | € |
|----------|-----|----------|------|------|
| 14730-00 | 1/9 | 176x110 | ● | 2,21 |
| 14730-11 | 1/9 | 176x110 | ● | 2,21 |
| 14730-22 | 1/9 | 176x110 | ● | 2,21 |
| 14730-33 | 1/9 | 176x110 | ● | 2,21 |
| 14730-99 | 1/9 | 176x110 | ○ | 2,21 |

IML POLYPROPYLENE POLIPROPILENE IML

GN FOOD PANS
CONTENITORI GN



With permanent in molded label. To write on the label there is a specific marker that can be removed by simply washing in the dishwasher. Withstand temperatures from -40°C to $+80^{\circ}\text{C}$. With both metric and American graduated scale. **WARNING:** polypropylene containers are not suitable for use on steam tables.

Con etichetta permanente costampata. Per scrivere sull'etichetta è disponibile un pennarello specifico che viene rimosso con il semplice lavaggio in lavastoviglie. Termoresistenti da -40°C a $+80^{\circ}\text{C}$. Scala graduata sia secondo sistema metrico che americano. **AVVERTENZE:** i contenitori in polipropilene non sono indicati per l'uso su tavole a vapore.



GN-containers

GN bacinelle
GN-Behälter
GN bacs
GN cubetas

| art. | GN | dim. mm. | h. mm. | lt. | € |
|----------|-----|----------|--------|------|-------|
| 15101-06 | 1/1 | 530x325 | 65 | 9,0 | 13,17 |
| 15101-10 | 1/1 | 530x325 | 100 | 13,3 | 15,08 |
| 15101-15 | 1/1 | 530x325 | 150 | 20,0 | 17,09 |
| 15101-20 | 1/1 | 530x325 | 200 | 26,4 | 22,11 |



| art. | GN | dim. mm. | h. mm. | lt. | € |
|----------|-----|----------|--------|------|-------|
| 15105-06 | 1/2 | 325x265 | 65 | 4,0 | 7,84 |
| 15105-10 | 1/2 | 325x265 | 100 | 6,1 | 8,44 |
| 15105-15 | 1/2 | 325x265 | 150 | 9,0 | 10,45 |
| 15105-20 | 1/2 | 325x265 | 200 | 11,9 | 12,26 |

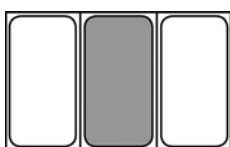

| art. | GN | dim. mm. | h. mm. | lt. | € |
|----------|-----|----------|--------|-----|-------|
| 15107-06 | 1/3 | 325x175 | 65 | 2,5 | 6,33 |
| 15107-10 | 1/3 | 325x175 | 100 | 3,8 | 7,14 |
| 15107-15 | 1/3 | 325x175 | 150 | 5,5 | 8,94 |
| 15107-20 | 1/3 | 325x175 | 200 | 7,1 | 10,65 |



| art. | GN | dim. mm. | h. mm. | lt. | € |
|----------|-----|----------|--------|-----|------|
| 15108-06 | 1/4 | 264x162 | 65 | 1,7 | 5,33 |
| 15108-10 | 1/4 | 264x162 | 100 | 2,6 | 5,93 |
| 15108-15 | 1/4 | 264x162 | 150 | 3,8 | 7,84 |
| 15108-20 | 1/4 | 264x162 | 200 | 4,8 | 9,45 |



| art. | GN | dim. mm. | h. mm. | lt. | € |
|----------|-----|----------|--------|-----|------|
| 15109-06 | 1/6 | 176x162 | 65 | 1,0 | 4,62 |
| 15109-10 | 1/6 | 176x162 | 100 | 1,6 | 5,23 |
| 15109-15 | 1/6 | 176x162 | 150 | 2,3 | 6,53 |
| 15109-20 | 1/6 | 176x162 | 200 | 2,8 | 6,93 |



| art. | GN | dim. mm. | h. mm. | lt. | € |
|----------|-----|----------|--------|-----|------|
| 15110-06 | 1/9 | 176x108 | 65 | 0,6 | 3,92 |
| 15110-10 | 1/9 | 176x108 | 100 | 0,9 | 4,32 |



Drainer plate

Falso fondo forato
Abtropfplatte
Plateau double fond perforé
Fondo perforado

| art. | GN | dim. mm. | € |
|----------|-----|----------|------|
| 14912-00 | 1/1 | 530x325 | 5,93 |
| 14915-00 | 1/2 | 325x265 | 3,62 |



GN hermetic lids with overmolded GASKET

Coperchi GN ermetici con GUARNIZIONE sovrastampata
GN hermetische Deckel mit umspritzter DICHUNG
Couvercles GN hermétiques avec JOINT surmoulé
Tapas GN herméticas con JUNTA sobremoldeada

| art. | GN | dim. mm. | € |
|----------|-----|----------|-------|
| 14942-99 | 1/1 | 530x325 | 15,98 |
| 14945-99 | 1/2 | 325x265 | 11,86 |
| 14947-99 | 1/3 | 325x175 | 8,14 |

GN-lids

GN coperchi
GN-Deckel
GN couvercles
GN tapas



| art. | GN | dim. mm. | col. | € |
|----------|-----|----------|------|------|
| 14922-00 | 1/1 | 530x325 | ● | 7,14 |
| 14922-11 | 1/1 | 530x325 | ● | 7,14 |
| 14922-22 | 1/1 | 530x325 | ● | 7,14 |
| 14922-33 | 1/1 | 530x325 | ● | 7,14 |
| 14922-77 | 1/1 | 530x325 | ● | 7,14 |
| 14922-99 | 1/1 | 530x325 | ○ | 7,14 |



| art. | GN | dim. mm. | col. | € |
|----------|-----|----------|------|------|
| 14925-00 | 1/2 | 325x265 | ● | 3,72 |
| 14925-11 | 1/2 | 325x265 | ● | 3,72 |
| 14925-22 | 1/2 | 325x265 | ● | 3,72 |
| 14925-33 | 1/2 | 325x265 | ● | 3,72 |
| 14925-77 | 1/2 | 325x265 | ● | 3,72 |
| 14925-99 | 1/2 | 325x265 | ○ | 3,72 |



| art. | GN | dim. mm. | col. | € |
|----------|-----|----------|------|------|
| 14927-00 | 1/3 | 325x175 | ● | 3,12 |
| 14927-11 | 1/3 | 325x175 | ● | 3,12 |
| 14927-22 | 1/3 | 325x175 | ● | 3,12 |
| 14927-33 | 1/3 | 325x175 | ● | 3,12 |
| 14927-77 | 1/3 | 325x175 | ● | 3,12 |
| 14927-99 | 1/3 | 325x175 | ○ | 3,12 |



| art. | GN | dim. mm. | col. | € |
|----------|-----|----------|------|------|
| 14928-00 | 1/4 | 264x162 | ● | 3,72 |
| 14928-11 | 1/4 | 264x162 | ● | 3,72 |
| 14928-22 | 1/4 | 264x162 | ● | 3,72 |
| 14928-33 | 1/4 | 264x162 | ● | 3,72 |
| 14928-77 | 1/4 | 264x162 | ● | 3,72 |
| 14928-99 | 1/4 | 264x162 | ○ | 3,72 |



| art. | GN | dim. mm. | col. | € |
|----------|-----|----------|------|------|
| 14929-00 | 1/6 | 176x162 | ● | 2,51 |
| 14929-11 | 1/6 | 176x162 | ● | 2,51 |
| 14929-22 | 1/6 | 176x162 | ● | 2,51 |
| 14929-33 | 1/6 | 176x162 | ● | 2,51 |
| 14929-77 | 1/6 | 176x162 | ● | 2,51 |
| 14929-99 | 1/6 | 176x162 | ○ | 2,51 |



| art. | GN | dim. mm. | col. | € |
|----------|-----|----------|------|------|
| 14930-00 | 1/9 | 176x108 | ● | 2,41 |
| 14930-11 | 1/9 | 176x108 | ● | 2,41 |
| 14930-22 | 1/9 | 176x108 | ● | 2,41 |
| 14930-33 | 1/9 | 176x108 | ● | 2,41 |
| 14930-77 | 1/9 | 176x108 | ● | 2,41 |
| 14930-99 | 1/9 | 176x108 | ○ | 2,41 |





Clips for lids
Clips per coperchi
Clips für Deckel
Clips pour couvercles
Clips para tapas

| art. | U. Pack | col. | € |
|----------|---------|------|------|
| 15100-01 | 12 | ● | 6,43 |
| 15100-02 | 12 | ● | 6,43 |
| 15100-03 | 12 | ● | 6,43 |
| 15100-04 | 12 | ● | 6,43 |
| 15100-07 | 12 | ● | 6,43 |



Kit 2 markers
Set 2 pennarelli
Satz 2 Marker
Set 2 marqueurs
Juego 2 marcadores

| art. | € |
|----------|-------|
| 15100-AA | 11,96 |

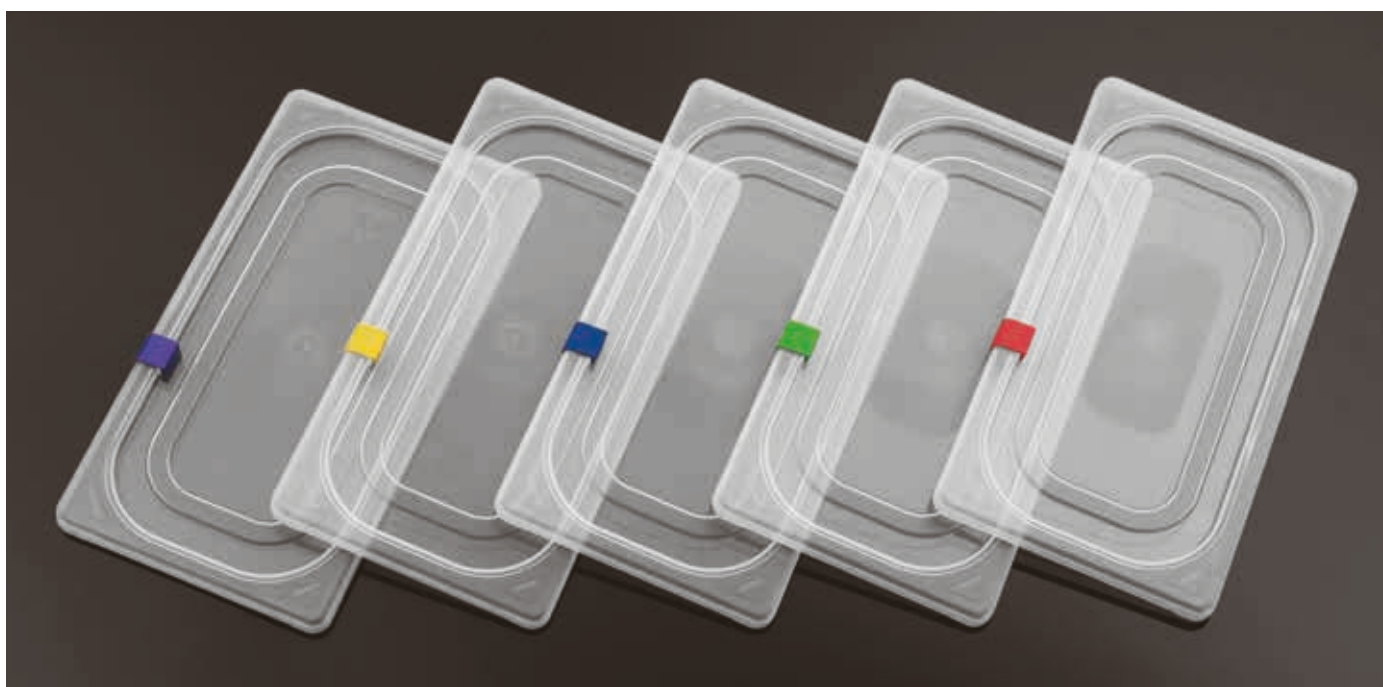



Melamine is suitable for hot and cold food use. Melamine is suitable for food storage at ambient or chilled temperatures for up to 24 hours. Melamine is not suitable for hot counters, displays, or heated cabinets. Do not expose melamine to direct flame or heat, including heat lamps and plate warmers. Temperature rating is between -20°C and 70°C (-4°F +158°F).

La melamina è adatta per l'uso sia con cibi caldi che freddi. La melamina è adatta per la conservazione degli alimenti a temperatura ambiente o refrigerata fino a 24 ore. La melamina non è adatta per piani caldi, espositori o armadi riscaldati. Non esporre a calore e fiamme dirette, incluse lampade alogene e scaldapiatti. Non esporre gli oggetti in melamina a temperature superiori a 70°C (-20°C +70°C).

GN-containers / Bacinelle / Behälter / Bacs / Cubetas



| art. | GN | dim. mm. | h. mm. | lt. | col. | € |
|----------|-----|----------|--------|------|------|-------|
| 44877-11 | 1/1 | 530X325 | 65 | 7,1 | ○ | 58,39 |
| 44877B11 | 1/1 | 530X325 | 100 | 10,6 | ○ | 68,84 |
| 44878-11 | 1/1 | 530X325 | 65 | 7,1 | ● | 58,39 |
| 44878B11 | 1/1 | 530X325 | 100 | 10,6 | ● | 68,84 |



| art. | GN | dim. mm. | h. mm. | lt. | col. | € |
|----------|-----|----------|--------|-----|------|-------|
| 44877-24 | 2/4 | 160x530 | 65 | 3,0 | ○ | 39,40 |
| 44877B24 | 2/4 | 160x530 | 100 | 4,3 | ○ | 48,74 |
| 44878-24 | 2/4 | 160x530 | 65 | 3,0 | ● | 39,40 |
| 44878B24 | 2/4 | 160x530 | 100 | 4,3 | ● | 48,74 |



| art. | GN | dim. mm. | h. mm. | lt. | col. | € |
|----------|-----|----------|--------|-----|------|-------|
| 44877-12 | 1/2 | 325X265 | 65 | 3,4 | ○ | 33,06 |
| 44877B12 | 1/2 | 325X265 | 100 | 4,7 | ○ | 40,10 |
| 44878-12 | 1/2 | 325X265 | 65 | 3,4 | ● | 33,06 |
| 44878B12 | 1/2 | 325X265 | 100 | 4,7 | ● | 40,10 |

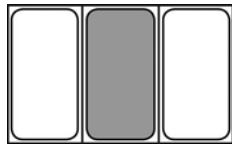

| art. | GN | dim. mm. | h. mm. | lt. | col. | € |
|----------|-----|----------|--------|-----|------|-------|
| 44877-13 | 1/3 | 325X175 | 65 | 2,0 | ○ | 28,24 |
| 44877B13 | 1/3 | 325X175 | 100 | 2,7 | ○ | 32,76 |
| 44878-13 | 1/3 | 325X175 | 65 | 2,0 | ● | 28,34 |
| 44878B13 | 1/3 | 325X175 | 100 | 2,7 | ● | 32,76 |



| art. | GN | dim. mm. | h. mm. | lt. | col. | € |
|----------|-----|----------|--------|-----|------|-------|
| 44877-14 | 1/4 | 265X160 | 65 | 1,4 | ○ | 25,33 |
| 44877B14 | 1/4 | 265X160 | 100 | 1,9 | ○ | 28,34 |
| 44878-14 | 1/4 | 265X160 | 65 | 1,4 | ● | 25,33 |
| 44878B14 | 1/4 | 265X160 | 100 | 1,9 | ● | 28,34 |



| art. | GN | dim. mm. | h. mm. | lt. | col. | € |
|----------|-----|----------|--------|-----|------|-------|
| 44877-16 | 1/6 | 175X160 | 65 | 0,8 | ○ | 20,10 |
| 44877B16 | 1/6 | 175X160 | 100 | 1,0 | ○ | 21,81 |
| 44878-16 | 1/6 | 175X160 | 65 | 0,8 | ● | 20,10 |
| 44878B16 | 1/6 | 175X160 | 100 | 1,0 | ● | 21,81 |



GN-lids, POLICARBONATE
GN-coperchi, POLICARBONATO
GN-Deckel, POLIKARBONAT
GN couvercles, POLICARBONATE
GN tapas, POLICARBONATO

PC

| art. | GN | dim. mm. | € |
|----------|-----|----------|-------|
| 44818-11 | 1/1 | 530X325 | 18,69 |
| 44818-12 | 1/2 | 325X265 | 10,85 |
| 44818-13 | 1/3 | 325X175 | 8,54 |
| 44818-14 | 1/4 | 265X160 | 6,93 |
| 44818-16 | 1/6 | 175X160 | 5,33 |



Buffet ladder, chrome plated
Espositore buffet, cromato
Büffet-Leiter, verchromt
Escalier à buffet, chromé
Escalera para buffet, cromada

GN

| art. | GN | dim. mm. | € |
|----------|-----|--------------|--------|
| 41403-01 | 1/3 | 31,5x32x48 | 131,66 |
| 41403-02 | 1/2 | 31,5x41,5x48 | 165,42 |
| 41403-03 | 1/2 | 31,5x56x66 | 269,94 |
| 41403-04 | 1/1 | 52x59x66 | 269,94 |



PORCELAIN PORCELLANA

GN FOOD PANS
CONTENITORI GN



GN-containers

GN bacinelle

GN-Behälter

GN bacs

GN cubetas

| art. | GN | dim. mm. | h. mm. | col. | € |
|----------|-----|----------|--------|------|--------|
| 44332-03 | 1/1 | 530x325 | 20 | ○ | 119,09 |
| 44332-06 | 1/1 | 530x325 | 65 | ○ | 126,83 |
| 44333-03 | 2/3 | 353x320 | 20 | ○ | - |
| 44333-06 | 2/3 | 353x320 | 65 | ○ | 66,13 |
| 44334-03 | 2/4 | 162x530 | 20 | ○ | 77,18 |
| 44334-06 | 2/4 | 162x530 | 65 | ○ | 83,11 |
| 44335-03 | 1/2 | 325x265 | 20 | ○ | 44,12 |
| 44335-06 | 1/2 | 325x265 | 65 | ○ | 48,74 |
| 44337-03 | 1/3 | 325x175 | 20 | ○ | 28,84 |
| 44337-06 | 1/3 | 325x175 | 65 | ○ | 33,97 |
| 44338-03 | 1/4 | 265x160 | 20 | ○ | 30,25 |
| 44338-06 | 1/4 | 265x160 | 65 | ○ | 32,16 |
| 44339-03 | 1/6 | 176x160 | 20 | ○ | 21,61 |
| 44339-06 | 1/6 | 176x160 | 65 | ○ | 23,82 |



| art. | GN | dim. mm. | h. mm. | col. | € |
|----------|-----|----------|--------|------|--------|
| 44332B06 | 1/1 | 530x325 | 65 | ● | 182,41 |
| 44333B06 | 2/3 | 353x320 | 65 | ● | 104,72 |
| 44335B06 | 1/2 | 325x265 | 65 | ● | 70,25 |
| 44337B06 | 1/3 | 325x175 | 65 | ● | 48,74 |



| art. | GN | dim. mm. | h. mm. | col. | € |
|----------|-----|----------|--------|------|--------|
| 44382A06 | 1/1 | 530x325 | 65 | ● | 178,79 |
| 44384A06 | 2/4 | 162x530 | 65 | ● | 117,18 |
| 44385A06 | 1/2 | 325x265 | 65 | ● | 68,74 |
| 44387A06 | 1/3 | 325x175 | 65 | ● | 47,84 |



| art. | GN | dim. mm. | h. mm. | col. | € |
|----------|-----|----------|--------|------|--------|
| 44382B06 | 1/1 | 530x325 | 65 | ● | 178,79 |
| 44385B06 | 1/2 | 325x265 | 65 | ● | 68,74 |
| 44387B06 | 1/3 | 325x175 | 65 | ● | 47,84 |



| art. | GN | dim. mm. | h. mm. | col. | € |
|----------|-----|----------|--------|------|--------|
| 44382G06 | 1/1 | 530x325 | 65 | ● | 178,79 |
| 44385G06 | 1/2 | 325x265 | 65 | ● | 68,74 |
| 44387G06 | 1/3 | 325x175 | 65 | ● | 47,84 |



| art. | GN | dim. mm. | h. mm. | col. | € |
|----------|-----|----------|--------|------|--------|
| 44382O06 | 1/1 | 530x325 | 65 | ● | 178,79 |
| 44383O06 | 2/3 | 353x320 | 65 | ● | 102,71 |
| 44384O06 | 2/4 | 162x530 | 65 | ● | 117,18 |
| 44385O06 | 1/2 | 325x265 | 65 | ● | 68,74 |
| 44387O06 | 1/3 | 325x175 | 65 | ● | 47,84 |



| art. | GN | dim. mm. | h. mm. | col. | € |
|----------|-----|----------|--------|------|--------|
| 44382Y06 | 1/1 | 530x325 | 65 | ● | 178,79 |
| 44383Y06 | 2/3 | 353x320 | 65 | ● | 102,71 |
| 44384Y06 | 2/4 | 162x530 | 65 | ● | 117,18 |
| 44385Y06 | 1/2 | 325x265 | 65 | ● | 68,74 |
| 44387Y06 | 1/3 | 325x175 | 65 | ● | 47,84 |

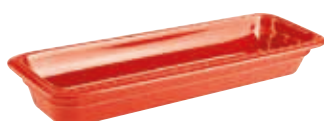

| art. | GN | dim. mm. | h. mm. | col. | € |
|----------|-----|----------|--------|------|--------|
| 44384R06 | 2/4 | 162x530 | 65 | ● | 117,18 |
| 44385R06 | 1/2 | 325x265 | 65 | ● | 68,74 |
| 44387R06 | 1/3 | 325x175 | 65 | ● | 47,84 |

INDUCTION PORCELAIN PORCELLANA INDUZIONE

GN FOOD PANS
CONTENITORI GN



INDUCTION
READY!





GN-containers

GN bacinelle

GN-Behälter

GN bacs

GN cubetas

| art. | GN | dim. mm. | h. mm. | col. | € |
|----------|-----|----------|--------|------|--------|
| 44342-06 | 1/1 | 530x325 | 65 | ○ | 308,64 |
| 44343-06 | 2/3 | 353x320 | 65 | ○ | 166,43 |
| 44344-06 | 2/4 | 162x530 | 65 | ○ | 193,06 |
| 44345-06 | 1/2 | 325x265 | 65 | ○ | 157,68 |
| 44347-06 | 1/3 | 325x175 | 65 | ○ | 77,89 |
| 44346-06 | 1/4 | 265x160 | 65 | ○ | 67,03 |



| art. | GN | dim. mm. | h. mm. | col. | € |
|----------|-----|----------|--------|------|--------|
| 44312A06 | 1/1 | 530x325 | 65 | ● | 371,65 |
| 44314A06 | 2/3 | 162x530 | 65 | ● | 233,86 |
| 44315A06 | 1/2 | 325x265 | 65 | ● | 183,92 |
| 44317A06 | 1/3 | 325x175 | 65 | ● | 94,57 |



| art. | GN | dim. mm. | h. mm. | col. | € |
|----------|-----|----------|--------|------|--------|
| 44312B06 | 1/1 | 530x325 | 65 | ● | 371,65 |
| 44313B06 | 2/3 | 353x320 | 65 | ● | 194,17 |
| 44314B06 | 2/4 | 162x530 | 65 | ● | 233,86 |
| 44315B06 | 1/2 | 325x265 | 65 | ● | 183,92 |
| 44317B06 | 1/3 | 325x175 | 65 | ● | 94,57 |



| art. | GN | dim. mm. | h. mm. | col. | € |
|----------|-----|----------|--------|------|--------|
| 44312G06 | 1/1 | 530x325 | 65 | ● | 371,65 |
| 44313G06 | 2/3 | 353x320 | 65 | ● | 194,17 |
| 44314G06 | 2/4 | 162x530 | 65 | ● | 233,86 |
| 44315G06 | 1/2 | 325x265 | 65 | ● | 183,92 |
| 44317G06 | 1/3 | 325x175 | 65 | ● | 94,57 |



| art. | GN | dim. mm. | h. mm. | col. | € |
|----------|-----|----------|--------|------|--------|
| 44312O06 | 1/1 | 530x325 | 65 | ● | 371,65 |
| 44313O06 | 2/3 | 353x320 | 65 | ● | 194,17 |
| 44314O06 | 2/4 | 162x530 | 65 | ● | 233,86 |
| 44315O06 | 1/2 | 325x265 | 65 | ● | 183,92 |
| 44317O06 | 1/3 | 325x175 | 65 | ● | 94,57 |



| art. | GN | dim. mm. | h. mm. | col. | € |
|----------|-----|----------|--------|------|--------|
| 44312R06 | 1/1 | 530x325 | 65 | ● | 371,65 |
| 44313R06 | 2/3 | 353x320 | 65 | ● | 194,17 |
| 44314R06 | 2/4 | 162x530 | 65 | ● | 233,86 |
| 44315R06 | 1/2 | 325x265 | 65 | ● | 183,92 |
| 44317R06 | 1/3 | 325x175 | 65 | ● | 94,57 |



| art. | GN | dim. mm. | h. mm. | col. | € |
|----------|-----|----------|--------|------|--------|
| 44312Y06 | 1/1 | 530x325 | 65 | ● | 371,65 |
| 44313Y06 | 2/3 | 353x320 | 65 | ● | 194,17 |
| 44314Y06 | 2/4 | 162x530 | 65 | ● | 233,86 |
| 44315Y06 | 1/2 | 325x265 | 65 | ● | 183,92 |
| 44317Y06 | 1/3 | 325x175 | 65 | ● | 94,57 |

SERIES 12900

KITCHEN UTENSILS
UTENSILI DA CUCINA

PA+
plus



A wide range of professional kitchen utensils in composite material, polyamide (nylon 6.6) with fiberglass. Dishwasher safe, can be sterilized, heat resistant up to 220°C. Safe for non-stick cookware.

Un'ampia gamma di utensili professionali per la cucina in materiale composito, poliammide (nylon 6.6) con fibra di vetro. Lavabili in lavastoviglie, sterilizzabili, resistenti fino a 220°C. Ideali per l'uso con antiaderenti.



PA+
plus

Spoon
Cucchiaione
Löffel
Mouvette
Cuchara

| art. | l. cm. | € |
|----------|--------|------|
| 12903-30 | 30 | 6,73 |
| 12903-40 | 38 | 7,44 |
| 12903-45 | 45 | 9,85 |



PA+
plus

Spatula
Spatola
Teigschäber
Spatule
Espátula

| art. | l. cm. | € |
|----------|--------|------|
| 12905-25 | 25 | 1,91 |
| 12905-30 | 30 | 2,61 |
| 12905-35 | 35 | 3,42 |
| 12905-40 | 40 | 5,13 |
| 12905-45 | 45 | 5,43 |
| 12905-50 | 50 | 6,53 |



PA+
plus

Stirring ladle
Spatola per stemperare
Rühr-u. Temperierlöffel
Spatule à délayer
Espátula para diluir

| art. | l. cm. | € |
|----------|--------|------|
| 12907-07 | 35 | 4,32 |
| 12907-08 | 35 | 3,92 |



PA+
plus

Spatula
Spatola
Stielschäber
Spatule
Espátula

| art. | l. cm. | € |
|----------|--------|-------|
| 12915-25 | 25 | 7,34 |
| 12915-26 | 28 | 8,34 |
| 12915-35 | 35 | 8,74 |
| 12915-45 | 45 | 10,35 |



PA+
plus

Spatula
Spatola
Teigschäber
Spatule
Espátula

| art. | l. cm. | € |
|----------|--------|------|
| 12916-25 | 25 | 8,34 |
| 12916-33 | 33 | 8,64 |



PA+
plus

Bevelled spatula
Spatola smussata
Teigschäber
Spatule plate biseautée
Espátula blanda

| art. | l. cm. | € |
|----------|--------|------|
| 12906-35 | 35 | 6,93 |



PA+
plus

Spatula
Spatola
Teigschäber
Spatule
Espátula

| art. | l. cm. | € |
|----------|--------|------|
| 12908-30 | 30 | 3,82 |
| 12908-35 | 35 | 5,03 |
| 12908-40 | 40 | 6,33 |



PA+
plus

Angular spatula
Paletta angolare
Winkelpalette
Spatule angulaire
Espátula

| art. | l. cm. | € |
|----------|--------|------|
| 12909-12 | 12 | 4,72 |
| 12909-23 | 23 | 5,03 |



PA+
plus

Spatula, perforated
Paletta forata
Teigschäber, perforiert
Spatule ajourée
Espátula perforada

| art. | l. cm. | € |
|----------|--------|------|
| 12921-01 | 30 | 3,32 |



PA+
plus

Spatula, perforated
Paletta forata
Teigschäber, perforiert
Spatule ajourée
Espátula perforada

| art. | l. cm. | € |
|----------|--------|------|
| 12921-05 | 30 | 3,62 |



PA+
plus

Spatula
Paletta
Teigschäber
Spatule
Espátula

| art. | l. cm. | € |
|----------|--------|------|
| 12921-10 | 32 | 5,03 |



PA+
plus

Fish & chips spatula
Paletta fritti
Fischheber
Pelle à friture
Espátula fritura

| art. | l. cm. | € |
|----------|--------|------|
| 12921-15 | 35 | 8,74 |



PA+
plus

Ladle
Mestolo
Schöpflöffel
Louche
Cacillo

| art. | Ø cm. | l. cm. | € |
|----------|-------|--------|------|
| 12920-01 | 9 | 31 | 5,63 |



PA+
plus

Skimmer
Schiumarola
Schaumlöffel
Ecumoire
Espumadera

| art. | Ø cm. | l. cm. | € |
|----------|-------|--------|------|
| 12920-05 | 11 | 35 | 5,33 |



PA+
plus

Spatula
Paletta
Teigschäber
Spatule
Espátula

| art. | cm. | l. cm. | € |
|----------|------|--------|------|
| 12920-10 | 9x10 | 35 | 5,33 |



PA+
plus

Fish & chips spatula
Paletta fritti
Fischheber
Pelle à friture
Espátula fritura

| art. | cm. | l. cm. | € |
|----------|------|--------|------|
| 12920-11 | 9x10 | 35 | 5,73 |



PA+
plus

Spoon
Cucchiaione
Giesslöffel
Cuillère
Cucharón

| art. | l. cm. | € |
|----------|--------|------|
| 12920-15 | 35 | 5,13 |



PA+
plus

Perforated spoon
Cucchiaione forato
Giesslöffel, perforiert
Cuillère perforée
Cucharón perforado

| art. | l. cm. | € |
|----------|--------|------|
| 12920-16 | 35 | 4,82 |



PA+
plus

Salad tongs
Molla insalata
Salatzange
Pince à salade
Pinza ensalada

| art. | l. cm. | € |
|----------|--------|------|
| 12930-51 | 25 | 4,02 |
| 12930-52 | 32 | 5,63 |



PA+
plus

Bread and pastry tongs
Molla per pane e pasticceria
Brot-/Gebäckzange
Pince à pain et pâtisserie
Pinza para pan y pasteleria

| art. | l. cm. | € |
|----------|--------|------|
| 12930-62 | 18 | 3,42 |
| 12930-63 | 23 | 4,62 |



PA+
plus

Serving tongs
Molla tutto servire
Servierzange
Pince à servir
Pinza servir

| art. | l. cm. | € |
|----------|--------|------|
| 12930-68 | 20 | 3,72 |
| 12930-69 | 25 | 5,93 |



PA+
plus

Spaghetti tongs
Molla spaghetti
Spaghettizange
Pince à spaghetti
Pinza espagueti

| art. | l. cm. | € |
|----------|--------|------|
| 12930-74 | 24 | 5,03 |



PA+
plus

Toast and pastry tongs
Molla per toast e dolci
Toast-/Gebäckzange
Pince à toast et tarte
Pinza para tostadas y dulces

| art. | l. cm. | € |
|----------|--------|------|
| 12930-77 | 21 | 3,82 |
| 12930-78 | 25 | 6,73 |



PA+
plus

Meat ball plier
Forbice per polpette
Fleischkugelzange
Pince à boulettes
Pinza albóndigas

| art. | l. cm. | € |
|----------|--------|------|
| 12931-51 | 17 | 3,92 |



PA+
plus

Quenelle plier
Forbice per chenelle
Quenellezange
Pince à quenelles
Pinza quenelles

| art. | l. cm. | € |
|----------|--------|------|
| 12931-53 | 19 | 5,63 |



PA+
plus

Perforated ladle
Mestolo forato
Schöpflöffel, gelocht
Louche perforée
Cacillo perforado

| art. | Ø cm. | l. cm. | € |
|----------|-------|--------|------|
| 12967-06 | 6,5 | 30 | 4,62 |
| 12967-10 | 10,0 | 37,5 | 9,55 |



PA+
plus

Ladle
Mestolo
Schöpflöffel
Louche
Cacillo

| art. | Ø cm. | l. cm. | € |
|-----------|-------|--------|-------|
| 12970-06* | 6,5 | 30,0 | 4,62 |
| 12970-08 | 8,0 | 33,5 | 6,33 |
| 12970-10 | 10,0 | 37,5 | 9,55 |
| 12970-12 | 12,0 | 40,0 | 11,86 |

*With spout. – Con becco.



PA+
plus

Pizza ladle, flat bottom
Mestolo pizza, fondo piatto
Schöpflöffel
Louche
Cacillo

| art. | Ø cm. | l. cm. | € |
|----------|-------|--------|------|
| 12968-10 | 10 | 27 | 9,55 |



PA+
plus

Ladle, short handle
Mestolo, manico corto
Schöpflöffel mit kurzen Stiel
Louche, manche court
Cacillo, mango corto

| art. | Ø cm. | l. cm. | € |
|----------|-------|--------|------|
| 12969-10 | 10 | 27 | 8,34 |



PA+
plus

Ladle, short handle
Mestolo, manico corto
Schöpflöffel mit kurzen Stiel
Louche, manche court
Cacillo, mango corto

| art. | Ø cm. | l. cm. | € |
|----------|-------|--------|------|
| 12969-06 | 6,5 | 24 | 3,92 |



PA+
plus

Spoon
Cucchiaione
Löffel
Cuillère
Cuchara

| art. | l. cm. | € |
|----------|--------|------|
| 12986-38 | 37,5 | 7,94 |



PA+
plus

Spoon, short handle
Cucchiaione, manico corto
Löffel mit kurzen Stiel
Cuillère, manche court
Cuchara, mango corto

| art. | l. cm. | € |
|----------|--------|------|
| 12986-01 | 23 | 5,63 |



PA+
plus

Skimmer
Schiumarola
Schaumlöffel
Ecumoire
Espumadera

| art. | Ø cm. | l. cm. | € |
|----------|-------|--------|------|
| 12971-10 | 10 | 31 | 4,32 |
| 12971-12 | 12 | 37 | 8,74 |



PA+
plus

Spatula
Paletta liscia
Backschaufel
Spatule
Espátula lisa

| art. | cm. | l. cm. | € |
|----------|-----|--------|-------|
| 12972-10 | 10 | 36,5 | 6,63 |
| 12972-12 | 12 | 38,0 | 10,75 |



PA+
plus

Perforated spatula
Paletta forata
Backschaufel, perforiert
Spatule perforée
Espátula perforada

| art. | cm. | l. cm. | € |
|----------|-----|--------|-------|
| 12973-10 | 10 | 36,5 | 6,53 |
| 12973-12 | 12 | 38 | 10,45 |



SS
PA+
plus

Wire whip, 8 silicone wires
Frusta, 8 fili silicone
Rührbesen, 8 Drähte aus Silikon
Fouet, 8 fils en silicone
Batidor, 8 varillas de siliconea

| art. | l. cm. | € |
|----------|--------|-------|
| 12926-35 | 35 | 29,95 |



SS
PA+
plus

Wire whip, 8 wires
Frusta, 8 fili
Rührbesen, 8 Drähte
Fouet, 8 fils
Batidor, 8 varillas

| art. | l. cm. | € |
|----------|--------|-------|
| 12928-25 | 25 | 15,98 |
| 12928-30 | 30 | 16,28 |
| 12928-35 | 35 | 19,80 |
| 12928-40 | 40 | 20,60 |
| 12928-45 | 45 | 21,41 |
| 12928-50 | 50 | 23,42 |
| 12928-55 | 55 | 25,93 |
| 12928-60 | 60 | 29,04 |



SS
PA+
plus

Egg whisk, 11 wires
Frusta media, 11 fili
Schneebesen, 11 Drähte
Fouet, 11 fils
Batidor, 11 varillas

| art. | l. cm. | € |
|----------|--------|-------|
| 12929-25 | 25 | 14,07 |
| 12929-30 | 30 | 16,28 |
| 12929-35 | 35 | 17,89 |
| 12929-40 | 40 | 18,89 |
| 12929-45 | 45 | 19,20 |

Water-tight, dishwasher safe.
Perfetta tenuta stagna, lavabile in lavastoviglie.



SS
PA+
plus

Balloon whisk
Frusta balloon
Schneebesen
Fouet à blancs
Batidor tipo globo

| art. | l. cm. | € |
|----------|--------|-------|
| 12927-35 | 35 | 17,59 |
| 12927-45 | 45 | 21,00 |

Water-tight, dishwasher safe.
Perfetta tenuta stagna, lavabile in lavastoviglie.

SERIES 48280 - 48278

KITCHEN UTENSILS
UTENSILI DA CUCINA



A wide range of professional kitchen utensils. These are essential tools to make original decorations as well as to ease the preparation of your recipes. All items are made of 18/10 stainless steel while their ergonomic handles are available both in stainless steel and Polypropylene. They are all hangable and can be cleaned in dishwasher. They boast a modern, functional design and are very easy to use.

Un'ampia gamma di utensili professionali per la cucina, indispensabili per creare decorazioni originali e fantasiose, ma utili anche per svolgere le più semplici operazioni in modo preciso e veloce. Tutti i pezzi sono realizzati in acciaio inox 18/10, mentre la manicatura ergonomica è prevista nella versione acciaio inox o polipropilene. Tutti gli articoli sono dotati di un foro sul manico per essere appesi. Lavabili in lavastoviglie. Il design è moderno e funzionale per il massimo comfort d'utilizzo.



Pizza chef knife

Coltello pizzaiolo
Messer für Pizzakoch
Couteau à chef de pizza
Cuchillo para chef de pizza

| art. | l. cm. | € |
|----------|--------|------|
| 48280-45 | 23,5 | 7,44 |



Pizza wheel

Rotella tagliapizza
Pizzaschneider
Roulette à pizza
Ruedecilla cortapizzas

| art. | Ø cm. | l. cm. | € |
|----------|-------|--------|-------|
| 18324-10 | 10 | 24 | 10,85 |



Pastry wheel

Rotella tagliapasta
Teigrädchen
Roulette à pâte
Ruedecilla para pasta

| art. | Ø cm. | l. cm. | € |
|----------|-------|--------|------|
| 48280-32 | 4 | 18 | 5,63 |



Double pastry wheel

Rotella tagliapasta doppia
Doppel-Teigrädchen
Roulette a pâte double
Ruedecilla para pasta doble

| art. | Ø cm. | l. cm. | € |
|----------|-------|--------|-------|
| 48280-39 | 4 | 18 | 11,16 |



Vegetable knife

Coltello verdure
Gemüsemesser
Couteau à légumes
Cuchillo para verduras

| art. | l. cm. | € |
|----------|--------|------|
| 48280-48 | 19 | 8,44 |



One-hand mincing knife

Falcetta prezzemolo
Einhandwiegemesser
Hachinette persil
Cuchillo para perejil

| art. | Ø cm. | l. cm. | € |
|----------|-------|--------|------|
| 48280-20 | 11 | 17 | 6,23 |



Parmesan cheese knife

Coltello grana
Parmesanmesser
Couteau à Parmesan
Cuchillo queso parmenso

| art. | l. cm. | € |
|----------|--------|------|
| 48280-04 | 20 | 9,35 |



Oyster knife

Coltello apriostriche
Austernmesser
Couteau à huîtres
Cuchillo ostras

| art. | l. cm. | € |
|----------|--------|------|
| 48280-05 | 20,5 | 9,35 |



Chestnut knife

Coltello castagne
Kastanienmesser
Couteau à châtaignes
Cuchillo castañas

| art. | l. cm. | € |
|----------|--------|------|
| 48280-21 | 16 | 2,21 |



Fish scaler

Squamapesce
Fischentschupper
Ecailleur
Raspador de escamas

| art. | l. cm. | € |
|----------|--------|-------|
| 48280-38 | 23,5 | 11,16 |



Double fish scaler

Squamapesce doppio
Fischentschupper
Ecailleur double
Raspador de escamas doble

| art. | cm. | € |
|----------|----------|-------|
| 48280-37 | 22,5x3,5 | 10,95 |



Cheese cleaver

Mannaietta per formaggio
Käsemesser
Couperet à fromage
Hachita para queso

| art. | cm. | € |
|----------|------|-------|
| 48280-49 | 21x4 | 11,16 |



Parmesan cheese knife

Coltello parmigiano
Parmesankäsemesser
Couteau à Parmesan
Cuchillo para queso parmesano

| art. | l. cm. | € |
|----------|--------|-------|
| 48280-46 | 24 | 10,15 |



Vegetable sharpener

Temperino per verdure
Spiralschneider
Taille crayon légumes
Afilador para vegetales

| art. | Ø cm. | € |
|----------|-------|------|
| 48280-12 | 4,5 | 5,13 |
| 48280-13 | 7,0 | 6,53 |



Basting brush

Pennello
Backpinsel
Pinceau
Pincel pastelería

| art. | cm. | € |
|----------|----------|------|
| 48280-94 | 22,5x3,5 | 5,33 |



Cheese slicer

Affetta formaggio
Käsehobel
Coupe-fromage
Cortador de queso

| art. | cm. | € |
|----------|--------|------|
| 48280-41 | 25x7,6 | 9,35 |



Cheese knife

Coltello formaggio
Käsemesser
Couteau à fromage
Cuchillo para queso

| art. | l. cm. | € |
|----------|--------|-------|
| 48280-59 | 27 | 12,76 |



Butter spreader

Spalmburro
Butterstreicher
Tartineur
Cuchillo mantequilla

| art. | l. cm. | € |
|----------|--------|------|
| 48280-75 | 21,5 | 5,43 |



Silicone basting brush

Pennello in silicone
Backpinsel, Silikon
Pinceau, silicone
Pincel pastelería, silicona

| art. | cm. | € |
|----------|--------|------|
| 48280-09 | 25,5x4 | 6,83 |

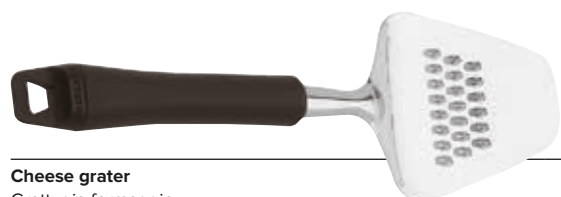

Cheese grater

Grattugia formaggio
Käseraffel
Râpe à fromage
Rallador de queso

| art. | l. cm. | € |
|----------|--------|---|
| 48280-06 | 24 | - |



Bottle opener

Levacapsule
Flaschenöffner
Décapsuleur
Abrebotellas

| art. | l. cm. | € |
|----------|--------|------|
| 48280-02 | 19 | 8,24 |



Can opener

Apriscatole
Flügel Dosenöffner
Ouvre-boîtes
Abrelatas

| art. | cm. | € |
|----------|--------|-------|
| 48280-03 | 22x4,6 | 17,29 |



Melon baller

Scavino
Kugelausstecher
Moule à pomme
Vaciador

| art. | Ø cm. | l. cm. | € |
|----------|-------|--------|------|
| 48280-24 | 1,0 | 19,0 | 6,33 |
| 48280-30 | 1,5 | 19,0 | 6,73 |
| 48280-31 | 2,0 | 19,0 | 7,34 |
| 48280-35 | 2,3 | 19,5 | 8,04 |
| 48280-36 | 3,0 | 19,5 | 8,54 |



Double melon baller

Scavino doppio
Kugelausstecher, doppel
Moule à pomme, double
Vaciador doble

| art. | Ø cm. | l. cm. | € |
|----------|---------|--------|------|
| 48286-67 | 2,2-3,0 | 17 | 7,94 |



Oval melon baller

Scavino ovale
Kugelausstecher, oval
Moule à pomme, ovale
Vciador oval

| art. | Ø cm. | l. cm. | € |
|----------|-------|--------|------|
| 48280-26 | 1,9 | 19,5 | 7,44 |



Zucchini corer, dented

Svuota zucchini
Zucchini-Entkerner
Vide-courgettes
Vaciador de zucchini

| art. | l. cm. | € |
|----------|--------|------|
| 48280-54 | 24,5 | 5,83 |



Pineapple coring tool

Svuota ananas
Ananasausstecher
Vide-ananas
Descorazonador de piña

| art. | l. cm. | € |
|----------|--------|------|
| 48280-10 | 25 | 7,54 |



Asparagus peeler

Pela asparagi
Spargelschäler
Éplucheur à asperges
Pelador de espárragos

| art. | l. cm. | € |
|----------|--------|-------|
| 48280-85 | 23,5 | 11,36 |



Tomato peeler

Pela pomodori
Tomatenschäler
Éplucheur à tomates
Pelador de tomates

| art. | l. cm. | € |
|----------|--------|------|
| 48280-08 | 18 | 8,94 |



Y-shaped swivel peeler

Sbucciatore a lama mobile
Pendelschäler
Éplucheur à lame pivotante
Pelador oscilante

| art. | l. cm. | € |
|----------|--------|------|
| 48280-53 | 18,5 | 8,54 |
| 48280-52 | 21,0 | 8,54 |



Melon peeler

Sbuccia melone
Melonenschäler
Éplucheur à melon
Pelador de melon

| art. | Ø cm. | l. cm. | € |
|----------|-------|--------|-------|
| 48280-60 | 8,0 | 20 | 17,49 |
| 48280-61 | 9,0 | 21 | 18,89 |
| 48280-62 | 10,5 | 22 | 21,00 |
| 48280-63 | 12,0 | 23 | 21,61 |



Potato peeler

Pelapatate
Kartoffelschäler
Éplucheur
Pelador de patatas

| art. | l. cm. | € |
|----------|--------|------|
| 48280-34 | 19,5 | 4,22 |



Orange peeler

Pelorange
Orangenschäler
Éplucheur à orange
Pelador de naranjas

| art. | l. cm. | € |
|----------|--------|------|
| 48280-96 | 20 | 9,05 |



Grapefruit knife

Coltello per pompelmo
Grapefruitmesser
Couteau à pamplemousse
Cuchillo para pomelo

| art. | l. cm. | € |
|----------|--------|------|
| 48280-47 | 21,5 | 6,93 |



Citrus bar knife

Coltello bar
Bar Messer
Couteau bar
Cuchillo bar

| art. | l. cm. | € |
|----------|--------|------|
| 48280-97 | 23 | 8,44 |



Fruit scoop

Cucchiaio scavino frutta
Fruchtlöffel
Cuillère à évider pour fruits
Cuchara ahueca frutas

| art. | l. cm. | € |
|----------|--------|------|
| 48280-15 | 20 | 6,13 |



Butter curler

Arricciaburro
Butterroller
Coquilleur à beurre
Rizador de mantequilla

| art. | l. cm. | € |
|----------|--------|------|
| 48280-11 | 22,5 | 7,34 |



Fruit decorator knife

Coltello decora frutta
Fruchtdekoriermesser
Couteau denteleur
Cuchillo para decorar fruta

| art. | l. cm. | € |
|----------|--------|------|
| 48280-91 | 23 | 7,04 |



Citrus stripper

Decoratore
Ziseliermesser
Canneleur
Rallador de cítricos

| art. | l. cm. | € |
|----------|--------|------|
| 48280-95 | 16,5 | 6,03 |



Citrus zester stripper

Rigalimoni decoratore
Zester Ziseliermesser
Zesteur canneleur
Acanalador rallador cítricos

| art. | l. cm. | € |
|----------|--------|------|
| 48280-92 | 17 | 8,04 |



Citrus zester

Rigalimoni
Zester
Zesteur
Acanalador de cítricos

| art. | l. cm. | € |
|----------|--------|------|
| 48280-90 | 17 | 6,53 |



Apple corer

Levatorsoli
Entkerner
Vide-pomme
Descorazonador

| art. | Ø cm. | l. cm. | € |
|----------|-------|--------|------|
| 48280-25 | 1,2 | 21 | 6,73 |



Wavy vegetable cutter

Tagliaverdure ondulato
Wellenschneider
Coupe-légumes ondulé
Cortador de verduras ondulado

| art. | l. cm. | € |
|----------|--------|------|
| 48280-23 | 11,5 | 5,93 |



Coil whisk

Frusta a spirale
Spiral Schneebesen
Fouet à spirale
Batidor espiral

| art. | Ø cm. | l. cm. | € |
|----------|-------|--------|-------|
| 48278-24 | 5 | 26,5 | 15,38 |



Pizza wheel

Rotella tagliapizza
Pizzaschneider
Roulette à pizza
Ruedecilla pizza

| art. | Ø cm. | l. cm. | € |
|----------|-------|--------|-------|
| 48278-33 | 7 | 21 | 14,47 |



Pastry wheel

Rotella tagliapasta
Teigrädchen
Roulette à pâte
Ruedecilla para pasta

| art. | Ø cm. | l. cm. | € |
|----------|-------|--------|-------|
| 48278-32 | 4 | 18 | 12,26 |



Double pastry wheel

Rotella tagliapasta doppia
Doppel-Teigrädchen
Roulette à pâte double
Ruedecilla para pasta doble

| art. | Ø cm. | l. cm. | € |
|----------|-------|--------|-------|
| 48278-39 | 4 | 18 | 16,68 |



Fish scaler

Squamapesce
Fischentschupper
Ecailleur
Quita escamas

| art. | l. cm. | € |
|----------|--------|-------|
| 48278-38 | 22 | 16,48 |



Paring knife

Spelucchino
Spickmesser
Couteau d'office
Cuchillo mondador

| art. | l. cm. | € |
|----------|--------|-------|
| 48278-55 | 22,5 | 13,37 |



Conical colander

Colino conico
Spitzsieb
Passoire chinois
Colador cónico

| art. | Ø cm. | l. cm. | € |
|----------|-------|--------|-------|
| 48278-13 | 16 | 35 | 34,77 |



Strainer

Colino
Sieb
Passoire
Colador

| art. | Ø cm. | l. cm. | € |
|----------|-------|--------|-------|
| 48278-12 | 8 | 27 | 18,49 |



Vegetable knife

Coltello verdure
Gemüsemesser
Couteau à légumes
Cuchillo para verduras

| art. | l. cm. | € |
|----------|--------|-------|
| 48278-48 | 19 | 13,77 |



Soft cheese slicer

Affetta formaggio tenero
Weichkäsehobel
Coupe-fromage à pâte molle
Cortador de queso blando

| art. | cm. | € |
|----------|--------|-------|
| 48278-42 | 20x7,5 | 14,57 |



Cheese cleaver

Mannaietta per formaggio
Käsemesser
Couperet à fromage
Hachita para queso

| art. | cm. | € |
|----------|------|-------|
| 48278-49 | 21x4 | 18,19 |



Parmesan cheese knife

Coltello parmigiano
Parmesankäsemesser
Coutau à Parmesan
Cuchillo queso parmeso

| art. | l. cm. | € |
|----------|--------|-------|
| 48278-46 | 23,5 | 17,09 |



Cheese slicer

Affetta formaggio
Käsehobel
Coupe-fromage
Cortador de queso

| art. | l. cm. | € |
|----------|--------|-------|
| 48278-41 | 25 | 15,38 |



Potato masher

Pressapatate
Kartoffelstampfer
Presse-purée
Prensador de patatas

| art. | cm. | l. cm. | € |
|----------|-----|--------|-------|
| 48278-87 | 8x7 | 27 | 18,59 |



Potato masher

Pressapatate
Kartoffelstampfer
Presse-purée
Prensador de patatas

| art. | cm. | € |
|----------|------|-------|
| 48278-31 | 27x8 | 22,21 |



Butter spreader

Spalmaburro
Butterstreicher
Tartineur
Cuchillo mantequilla

| art. | l. cm. | € |
|----------|--------|-------|
| 48278-75 | 21 | 12,26 |



Grater

Grattugia
Raffel
Râpe
Rallador

| art. | cm. | € |
|----------|----------|-------|
| 48278-20 | 25,5x5,5 | 13,77 |



Grater

Grattugia
Raffel
Râpe
Rallador

| art. | cm. | € |
|----------|----------|-------|
| 48278-21 | 25,5x5,5 | 13,87 |



Oyster knife

Coltello apriostriche
Austernmesser
Couteau à huîtres
Cuchillo para ostras

| art. | l. cm. | € |
|----------|--------|-------|
| 48278-45 | 20 | 14,57 |



Straight icing spatula

Spatola per glassa
Glasurpalette
Spatule glaçage plate
Espátula pastelera

| art. | l. cm. | € |
|----------|--------|-------|
| 48278-77 | 27,5 | 16,18 |



Basting brush

Pennello
Backpinsel
Pinceau cuisine
Pincel pastelería

| art. | l. cm. | € |
|----------|--------|-------|
| 48278-94 | 22 | 11,66 |



Garlic press

Spremiaglio
Knoblauchpresse
Presse-ail
Prensador de ajo

| art. | cm. | € |
|----------|------|-------|
| 48278-37 | 19x5 | 38,49 |



Jar opener

Apribarattoli
Einmachglasöffner
Ouvre-bocal
Abridor de tarros

| art. | cm. | € |
|----------|----------|-------|
| 48278-01 | 25,5x8,5 | 27,64 |



Bottle opener

Levacapsule
Flaschenöffner
Ouvre-bouteille
Abrebotellas

| art. | cm. | € |
|----------|--------|-------|
| 48278-02 | 19x3,7 | 12,76 |



Zucchini corer

Svuota zucchine
Zucchini-Entkerner
Vide-courgettes
Vaciador de zucchini

| art. | l. cm. | € |
|----------|--------|-------|
| 48278-54 | 25 | 11,76 |



Swivel peeler

Sbucciatore a lama mobile
Pendelschäler
Éplucheur à lame pivotante
Pelador oscilante

| art. | l. cm. | € |
|----------|--------|-------|
| 48278-52 | 21 | 12,26 |



Y-shaped swivel peeler

Sbucciatore a Y
Y-Pendelschäler
Éplucheur
Pelador Y

| art. | l. cm. | € |
|----------|--------|-------|
| 48278-53 | 18,5 | 13,47 |



Apple corer

Levatoroli
Apfelentkerner
Vide-pomme
Descorazonador de manzana

| art. | Ø cm. | l. cm. | € |
|----------|-------|--------|-------|
| 48278-25 | 1,6 | 21,5 | 13,57 |



Potato fork 3 prongs

Forchettina patate 3 punte
Pellkartoffelgabel 3 Zinken
Fourchette à pommes de terre
Tenedor tridente para patatas

| art. | l. cm. | € |
|----------|--------|-------|
| 48278-17 | 16,5 | 10,15 |



Can opener

Apriscatole
Flügeldosenöffner
Ouvre-boîte
Abrelatas

| art. | cm. | € |
|----------|--------|-------|
| 48278-03 | 22x4,6 | 32,26 |



Potato peeler

Pelapatate
Kartoffelschäler
Éplucheur
Pelador de patatas

| art. | l. cm. | € |
|----------|--------|------|
| 48278-34 | 19,5 | 9,55 |



Melon baller

Scavino
Kugelausstecher
Moule à pomme
Vaciador

| art. | Ø cm. | l. cm. | € |
|----------|-------|--------|-------|
| 48278-35 | 3 | 18 | 13,47 |



Orange peeler

Pelaranca
Orangenschäler
Éplucheur à orange
Pelador de naranja

| art. | l. cm. | € |
|----------|--------|-------|
| 48278-96 | 20 | 13,77 |



Grapefruit knife

Coltello per pompelmo
Grapefruitmesser
Couteau à pamplemousse
Cuchillo para pomelo

| art. | l. cm. | € |
|----------|--------|---|
| 48278-47 | 21,5 | - |



Ice cream scoop

Porzionatore gelato
Eisportionierer
Cuillère à glace
Porcionador para helado

| art. | Ø cm. | l. cm. | € |
|----------|-------|--------|-------|
| 48278-95 | 4 | 21 | 16,48 |



Coffee measuring spoon

Dosacaffè
Kaffeedosierlöffel
Cuillère doaseuse à café
Cuchara dosificador de café

| art. | Ø cm. | l. cm. | € |
|----------|-------|--------|-------|
| 48278-16 | 3,5 | 20 | 14,97 |



Egg separator

Separauova
Eiertrenner
Séparateur d'oeuf
Separador de huevos

| art. | Ø cm. | l. cm. | € |
|----------|-------|--------|-------|
| 48278-36 | 5,5 | 20,5 | 16,88 |



Fruit decorator knife

Coltello decora frutta
Fruchtdekoriermesser
Couteau denteleur
Cuchillo para decorar frutas

| art. | l. cm. | € |
|----------|--------|-------|
| 48278-91 | 22,5 | 12,16 |



Cocktail spoon

Cucchiaio cocktail
Cocktaillöffel
Cuiller à cocktail
Cuchara cóctel

| art. | Ø cm. | l. cm. | € |
|----------|-------|--------|-------|
| 48278-15 | 6 | 28 | 14,07 |



Citrus zester stripper

Rigalimoni decoratore
Zester Ziseliermesser
Zesteur canneléur
Acanalador rallador cítricos

| art. | l. cm. | € |
|----------|--------|-------|
| 48278-92 | 16,5 | 13,37 |



Butter curler

Arricciaburro
Butterroller
Coquilleur à beurre
Rizador de mantequilla

| art. | l. cm. | € |
|----------|--------|-------|
| 48278-11 | 21,5 | 13,57 |



Odor eliminator soap bar

Saponetta togli odori
Geruch Entferner Seife
Savonette enlève odeurs
Jabón quita odores

| art. | cm. | € |
|----------|---------|-------|
| 48278-99 | 7,5x5,5 | 15,78 |



Sauce ladle

Mestolino salsa
Saucenlöffel
Louche à sauce
Cacillo salsas

| art. | Ø cm. | l. cm. | € |
|----------|-------|--------|-------|
| 48278-68 | 7 | 29 | 21,51 |



Soup ladle

Mestolo
Schöpflöffel
Louche à soupe
Cazo sopa

| art. | Ø cm. | l. cm. | € |
|----------|-------|--------|-------|
| 48278-69 | 9 | 32 | 22,21 |
| 48278-66 | 6 | 29 | 19,50 |



Salad serving fork

Forchetta servire insalata
Salatserviergabel
Fourchette à servir salade
Tenedor servir ensalada

| art. | Ø cm. | l. cm. | € |
|----------|-------|--------|-------|
| 48278-64 | 5 | 25,5 | 18,09 |



Salad spoon

Cucchiaio per insalata
Salatlöffel
Cuillère à salade
Cucharón ensalada

| art. | Ø cm. | l. cm. | € |
|----------|-------|--------|-------|
| 48278-62 | 5 | 25 | 18,09 |



Perforated spoon

Cucchiaio forato
Giesslöffel, perforiert
Cuillère percée
Cuchara perforada

| art. | cm. | € |
|----------|------|-------|
| 48278-61 | 34x6 | 18,69 |



Slotted turner

Paletta forata
Küchenwender, perforiert
Pelle ajourée
Espátula perforada

| art. | cm. | € |
|----------|----------|-------|
| 48278-71 | 34,5x8,5 | 17,89 |



Skimmer

Schiumarola
Schaumlöffel
Ecumoire
Espumadera

| art. | Ø cm. | l. cm. | € |
|----------|-------|--------|-------|
| 48278-73 | 11 | 37 | 22,71 |



Spatula

Spatola
Spachtel
Spatule
Espátula

| art. | cm. | € |
|----------|----------|-------|
| 48278-76 | 28,5x5,6 | 13,77 |



Cake server

Pala torta
Tortenheber
Pelle à tarte
Pala tarta

| art. | cm. | € |
|----------|--------|-------|
| 48278-93 | 26x5,8 | 15,38 |



Spaghetti server

Servispaghetti
Spaghettilöffel
Cuillère à spaghetti
Servidor para espagueti

| art. | Ø cm. | l. cm. | € |
|----------|-------|--------|-------|
| 48278-74 | 7 | 30,5 | 20,90 |



Meat fork

Forchettone
Fleischgabel
Fourchette à viande
Tenedor trinchar

| art. | l. cm. | € |
|----------|--------|-------|
| 48278-65 | 32,5 | 16,58 |



Rice spoon

Cucchiaio risotto
Reislöffel
Cuillère de service à riz
Cuchara arroz

| art. | l. cm. | € |
|----------|--------|-------|
| 48278-63 | 27 | 17,29 |



Spatula

Spatola lasagne
Lasagne Spatel
Palette
Espátula lasaña

| art. | cm. | € |
|----------|--------|-------|
| 48278-27 | 29x4,5 | 16,78 |



Skimmer

Schiumarola
Schaumlöffel
Ecumoire
Espumadera

| art. | Ø cm. | l. cm. | € |
|----------|-------|--------|-------|
| 48278-88 | 11 | 36,5 | 14,97 |



Soup ladle

Mestolo
Schöpflöffel
Louche à soupe
Cazo sopa

| art. | Ø cm. | l. cm. | € |
|----------|-------|--------|-------|
| 48278-84 | 9,5 | 32,5 | 14,87 |



Rice spoon

Cucchiaio riso
Reislöffel
Cuillère de service à riz
Cuchara arroz

| art. | cm. | € |
|----------|--------|-------|
| 48278-82 | 33x6,5 | 13,77 |



Perforated spoon

Cucchiaio forato
Gießlöffel, perforiert
Cuillère percée
Cuchara perforada

| art. | cm. | € |
|----------|--------|-------|
| 48278-81 | 33x6,5 | 13,77 |



Spaghetti server

Servispaghetti
Spaghettillöffel
Cuillère à spaghetti
Servidor para espagueti

| art. | cm. | € |
|----------|--------|-------|
| 48278-89 | 32x6,5 | 13,87 |



Meat fork

Forchettone
Fleischgabel
Fourchette à viande
Tenedor trinchar

| art. | l. cm. | € |
|----------|--------|-------|
| 48278-83 | 32,5 | 13,97 |



Silicone basting spoon

Cucchiaione in silicone
Gießlöffel aus Silikon
Cuillère de service en silicone
Cuchara para servir de silicona

| art. | cm. | l. cm. | € |
|----------|-------|--------|-------|
| 48278-14 | 5,5x8 | 26,5 | 17,69 |



Perforated spatule

Paletta forata
Küchenwender, perforiert
Pelle ajourée
Pala perforada

| art. | cm. | € |
|----------|--------|-------|
| 48278-85 | 33x8,5 | 13,87 |



Silicone dough scraper

Spatola in silicone
Teigschaber aus Silikon
Pelle en silicone
Paleta de silicona

| art. | cm. | l. cm. | € |
|----------|-----|--------|-------|
| 48278-28 | 5x9 | 28,5 | 15,28 |



Whisk

Frusta
Schneebeesen
Fouet
Batidor

| art. | l. cm. | € |
|----------|--------|-------|
| 48278-18 | 24,5 | 9,75 |
| 48278-19 | 29,5 | 11,16 |

TURNERS SPATOLE

KITCHEN UTENSILS
UTENSILI DA CUCINA

SS PP



Stainless steel turners with polypropylene handle.

Spatole in acciaio inox con manico in polipropilene.



Pizza server
Spatola per pasticcio e pizza
Pizzawender
Pelle à pizza
Espátula pizza

| art. | cm. | € |
|----------|----------|------|
| 18511-15 | 15,5x8,7 | 9,65 |



Hamburger turner
Spatola hamburger
Hamburgerspachtel
Pelle à hamburger
Espátula hamburguesa

| art. | cm. | € |
|----------|---------|-------|
| 18512-15 | 19x13,8 | 13,67 |



Lasagne spatula
Spatola lasagne
Lasagneheber
Pelle à lasagne
Espátula lasaña

| art. | cm. | € |
|----------|----------|------|
| 18515-16 | 16,8x7,2 | 7,64 |



Triangular spatula
Spatola triangolare
Dreieckiger Spachtel
Spatule triangulaire
Espátula triangular

| art. | cm. | € |
|----------|-------|------|
| 18520-04 | 12x4 | 5,23 |
| 18520-06 | 12x6 | 5,73 |
| 18520-08 | 12x8 | 6,43 |
| 18520-10 | 12x10 | 7,74 |
| 18520-12 | 12x12 | 8,24 |



Hamburger turner
Spatola hamburger
Pfannenwender
Grand palette à hamburger
Espátula hamburguesa

| art. | cm. | € |
|----------|--------|------|
| 18516-24 | 24x7,2 | 7,94 |



Perforated hamburger turner
Spatola hamburger, forata
Pfannenwender, gelocht
Grand palette perforée
Espátula hamburguesa, perforada

| art. | cm. | € |
|----------|--------|------|
| 18517-24 | 24x7,2 | 8,14 |



Perforated turner
Paletta forata
Kuchenpalette, geschlitzt
Palette perforée
espátula perforada

| art. | cm. | € |
|----------|--------|------|
| 18510-07 | 13,5x7 | 7,04 |



Slotted spatula
Spatola forata
Pfannenwender, geschlitzt
Palette ajourée
espátula perforada

| art. | cm. | € |
|----------|--------|------|
| 18509-01 | 16x7,5 | 5,83 |



Slotted spatula
Spatola forata
Pfannenwender, geschlitzt
Palette ajourée
espátula perforada

| art. | cm. | € |
|----------|--------|------|
| 18509-02 | 15,6x5 | 5,33 |



Slotted spatula, flexible
Paletta forata, flessibile
Pfannenwender, geschlitzt, flexibel
Palette ajourée flexible
espátula perforada flexible

| art. | cm. | € |
|----------|----------|------|
| 18509-03 | 15,6x8,7 | 6,43 |



Bent icing spatula
Spatola cuoco con scalino
Confiseriepalette
Palette coudée
Espátula pastelera acodada

| art. | cm. | € |
|----------|--------|------|
| 18518-22 | 22x3,4 | 7,04 |
| 18518-26 | 25x3,7 | 7,34 |
| 18518-30 | 30x4,3 | 8,54 |



Straight icing spatula
Spatola cuoco
Back- und Glasurpalette
Spatule glaçage plate
Espátula pastelera lisa

| art. | cm. | € |
|----------|--------|------|
| 18519-15 | 15,5x3 | 4,32 |
| 18519-22 | 22x3,4 | 4,82 |
| 18519-26 | 26x3,7 | 5,33 |
| 18519-30 | 31x4,3 | 6,33 |
| 18519-35 | 36x5 | 6,93 |



Pie server
Paletta dolci
Gebäckpalette
Palette à gâteau
Espátula pasteles

| art. | cm. | € |
|----------|----------|------|
| 18513-14 | 14,5x6,5 | 5,23 |



Pie server serrated edge
Pala torta seghettata
Kuchenschaufel gezackte Kante
Pelle à gâteau côté dentelé
Pala pasteles filo dentado

| art. | cm. | € |
|----------|----------|------|
| 18514-17 | 16,3x5,8 | 6,03 |



Pie server serrated edge
Pala torta seghettata
Kuchenschaufel gezackte Kante
Pelle à gâteau côté dentelé
Pala pasteles filo dentado

| art. | cm. | € |
|----------|----------|------|
| 18514-18 | 17,3x5,8 | 6,33 |

Bent. – Con scalino.

LADLES MESTOLI

KITCHEN UTENSILS
UTENSILI DA CUCINA



The PADERNO ladle.
Handle-cup connection (one piece ladle). Thicker handle with rounded border.
Diameter and capacity stamped on the handle.

Il mestolo PADERNO.
Accoppiamento manico-coppa (mestolo unipezzo). Manico con spessore maggiorato con bordi arrotondati. Indicazione sul manico del diametro e della capacità.



NSF
SS

One piece ladle
Mestolo unipezzo
Schöpflöffel, fugenlos
Louche monobloc
Cacillo monobloc

| art. | Ø cm. | l. cm. | lt. | € |
|----------|-------|--------|------|-------|
| 11970-06 | 6,5 | 30 | 0,07 | 9,45 |
| 11970-08 | 8,0 | 32 | 0,12 | 10,95 |
| 11970-09 | 9,0 | 33 | 0,20 | 11,56 |
| 11970-10 | 10,0 | 37 | 0,25 | 14,57 |
| 11970-11 | 11,0 | 38 | 0,33 | 16,18 |
| 11970-12 | 12,0 | 40 | 0,50 | 18,29 |
| 11970-14 | 14,0 | 44 | 0,75 | 32,96 |
| 11970-16 | 16,0 | 47 | 1,00 | 37,89 |



NSF
SS

Ladle, tube handle
Mestolo con manico a tubo
Schöpflöffel mit Rohrstiel
Louche avec manche tubulaire
Cacillo con mango tubular

| art. | Ø cm. | l. cm. | lt. | € |
|----------|-------|--------|-----|-------|
| 11968-18 | 18 | 75 | 1,5 | 43,82 |
| 11968-20 | 20 | 75 | 2,0 | 51,66 |
| 11968-24 | 24 | 75 | 4,0 | 66,73 |



NSF
SS

One piece perforated ladle
Mestolo forato unipezzo
Gelochter Schöpflöffel, fugenlos
Louche monobloc perforée
Cacillo monobloc perforado

| art. | Ø cm. | l. cm. | lt. | € |
|----------|-------|--------|------|-------|
| 11967-06 | 6,5 | 30 | 0,07 | 13,67 |
| 11967-08 | 8 | 32 | 0,12 | 15,38 |
| 11967-09 | 9 | 33 | 0,20 | 16,48 |
| 11967-10 | 10 | 37 | 0,25 | 18,89 |
| 11967-12 | 12 | 40 | 0,50 | 21,31 |
| 11967-14 | 14 | 44 | 0,75 | 38,79 |
| 11967-16 | 16 | 47 | 1,00 | 42,01 |



NSF
SS

Perforated ladle, tube handle
Mestolo forato con manico a tubo
Schöpflöffel, gelocht mit Rohrstiel
Louche perforée, manche tubulaire
Cacillo perforado mango tubular

| art. | Ø cm. | l. cm. | lt. | € |
|----------|-------|--------|-----|-------|
| 11967-18 | 18 | 75 | 1,5 | 53,06 |
| 11967-20 | 20 | 75 | 2,0 | 55,88 |
| 11967-24 | 24 | 75 | 4,0 | 71,36 |



NSF
SS

One piece side basting spoon
Mestolo becco a versare unipezzo
Saucenkelle quer, fugenlos
Cuillère à arroser monobloc
Cacillo monobloc para versar

| art. | Ø cm. | l. cm. | lt. | € |
|-----------|-------|--------|------|-------|
| 11969-06 | 6,5 | 30 | 0,07 | 12,16 |
| 11969-37* | 6,5 | 30 | 0,07 | 12,16 |

*Left handed. – Per mancini.



NSF
SS

One piece basting spoon
Cucchiaione unipezzo
Giesslöffel, fugenlos
Cuillère monobloc
Cucharón monobloc

| art. | l. cm. | € |
|----------|--------|-------|
| 11982-38 | 38 | 12,56 |



NSF
SS

One piece perforated spoon
Cucchiaione forato unipezzo
Giesslöffel perforiert, fugenlos
Cuillère perforée monobloc
Cucharón perforado monobloc

| art. | l. cm. | € |
|----------|--------|-------|
| 11984-38 | 38 | 12,96 |



NSF
SS

One piece spoon, crosswise
Cucchiaione obliquo unipezzo
Giesslöffel quer, fugenlos
Cuillère oblique monobloc
Cucharón obliquo monobloc

| art. | l. cm. | € |
|-----------|--------|-------|
| 11983-38 | 38 | 12,56 |
| 11983-37* | 38 | 12,56 |

*Left handed. – Per mancini.



NSF
SS

One piece meat fork, 3 prongs
Forchettone 3 denti unipezzo
Fleischgabel 3 Zacken, fugenlos
Fourchette 3 dents, monobloc
Tenedor 3 dientes, monobloc

| art. | l. cm. | € |
|----------|--------|-------|
| 11974-50 | 50 | 27,03 |
| 11974-70 | 70 | 30,35 |



NSF
SS

One piece meat fork, 2 prongs
Forchettone 2 denti unipezzo
Fleischgabel 2 Zacken, fugenlos
Fourchette 2 dents, monobloc
Tenedor 2 dientes, monobloc

| art. | l. cm. | € |
|----------|--------|-------|
| 11975-50 | 50 | 25,73 |
| 11975-99 | 100 | 33,57 |



NSF
SS

One piece spatula
Paletta liscia unipezzo
Backschaufel, fugenlos
Spatule monobloc
Espátula lisa monobloc

| art. | cm. | l. cm. | € |
|----------|-----|--------|-------|
| 11972-10 | 10 | 36 | 11,16 |
| 11972-12 | 12 | 39 | 12,96 |



NSF
SS

One piece perforated spatula
Paletta forata unipezzo
Backschaufel perforiert, fugenlos
Spatule perforée monobloc
Espátula perforada monobloc

| art. | cm. | l. cm. | € |
|----------|-----|--------|-------|
| 11973-10 | 10 | 36 | 12,36 |
| 11973-12 | 12 | 39 | 13,47 |



NSF
SS

Perforated slice
Pala a ridurre
Reduzierspatel
Spatule à réduire
Espátula para reducir

| art. | cm. | l. cm. | € |
|----------|-------|--------|-------|
| 11976-50 | 12x15 | 50 | 30,55 |
| 11976-99 | 12x15 | 100 | 42,71 |



NSF
SS

One piece fish spatula
Paletta pesce unipezzo, forata
Fischwender, fugenlos
Pelle à poisson monobloc
Pala pescado, monobloc

| art. | cm. | l. cm. | € |
|----------|-------|--------|-------|
| 11985-34 | 15x20 | 42 | 14,77 |



NSF
SS

One piece skimmer
Schiumarola unipezzo
Schaumlöffel, fugenlos
Ecumoire monobloc
Espumadera monobloc

| art. | Ø cm. | l. cm. | € |
|----------|-------|--------|-------|
| 11971-08 | 8 | 29,0 | 9,55 |
| 11971-10 | 10 | 32,0 | 10,35 |
| 11971-12 | 12 | 35,0 | 12,56 |
| 11971-14 | 14 | 38,0 | 25,33 |
| 11971-16 | 16 | 41,0 | 28,94 |
| 11971-18 | 18 | 42,5 | 34,57 |
| 11971-20 | 20 | 44,5 | 37,29 |



NSF
SS

One piece skimmer, tube handle
Schiumarola unipezzo, manico a tubo
Schaumlöffel, fugenlos, mit Rohrstiel
Ecumoire monobloc, manche tubulaire
Espumadera monobloc, mango tubular

| art. | Ø cm. | l. cm. | € |
|----------|-------|--------|-------|
| 11971-25 | 25 | 75 | 61,91 |



NSF
SS

One piece ladle
Mestolo unipezzo
Schöpflöffel, fugenlos
Louche monobloc
Cacillo monobloc

| art. | Ø cm. | l. cm. | lt. | € |
|----------|-------|--------|------|-------|
| 11970-01 | 8 | 23 | 0,12 | 11,66 |

Short handle. – Manico corto.



NSF
SS

Side basting spoon
Mestolo con becco a versare
Saucenkelle mit seitlichem Ausguß
Cuillère à arroser
Cacillo para versar

| art. | Ø cm. | l. cm. | lt. | € |
|----------|-------|--------|------|-------|
| 11969-02 | 6,5 | 23 | 0,07 | 11,66 |

Short handle. – Manico corto.



NSF
SS

One piece spoon
Cucchiaione unipezzo
Giesslöffel, fugenlos
Cuillère monobloc
Cuchara monobloc

| art. | l. cm. | € |
|----------|--------|-------|
| 11982-01 | 23,5 | 13,37 |

Short handle. – Manico corto.



NSF
SS

One piece meat fork
Forchettone unipezzo
Fleischgabel, fugenlos
Fourchette monobloc
Tenedor monobloc

| art. | l. cm. | € |
|----------|--------|-------|
| 11975-01 | 26 | 14,07 |

Short handle. – Manico corto.



NSF
SS

One piece perforated spatula
Paletta forata unipezzo
Backschaufel perforiert, fugenlos
Spatule perforée monobloc
Espátula perforada monobloc

| art. | cm. | l. cm. | € |
|----------|-------|--------|-------|
| 11973-01 | 8x9,5 | 24 | 12,26 |

Short handle. – Manico corto.



NSF

SS

One piece skimmer
Schiumarola unipezzo
Schaumlöffel, fugenlos
Ecumoire monobloc
Espumadera monobloc

| art. | Ø cm. | l. cm. | € |
|----------|-------|--------|-------|
| 11971-01 | 9 | 26 | 10,55 |

Short handle. – Manico corto.



SS

Ladle
Mestolo
Schöpflöffel
Louche
Cacillo

| art. | Ø cm. | l. cm. | lt. | € |
|----------|-------|--------|------|-------|
| 41670-06 | 6 | 30 | 0,03 | 15,38 |
| 41670-09 | 9 | 32 | 0,13 | 19,90 |



SS

Skimmer
Schiumarola
Schaumlöffel
Ecumoire
Espumadera

| art. | Ø cm. | l. cm. | € |
|----------|-------|--------|-------|
| 41671-11 | 11 | 32 | 18,29 |



SS

Slotted turner
Paletta forata
Küchenwender, geschlitzt
Pelle ajourée
Espátula perforada

| art. | l. cm. | € |
|----------|--------|-------|
| 41672-00 | 32 | 15,08 |



SS

Spaghetti spoon
Cucchiaio per spaghetti
Spaghettilöffel
Cuillère à spaghetti
Tenedor espaguetis

| art. | l. cm. | € |
|----------|--------|-------|
| 41673-00 | 32 | 17,69 |



SS

Meat fork
Forchettone
Fleischgabel
Fourchette
Tenedor

| art. | l. cm. | € |
|----------|--------|-------|
| 41674-00 | 32 | 12,86 |



SS

Basting spoon
Cucchiaione
Giesslöffel
Cuillère
Cuchara

| art. | l. cm. | € |
|----------|--------|-------|
| 41675-00 | 32 | 14,37 |



SS

Perforated spoon
Cucchiaione forato
Schöpfkelle, gelocht
Cuillère percée
Cuchara perforada

| art. | l. cm. | € |
|----------|--------|-------|
| 41676-00 | 32 | 14,47 |



SS

Sauce ladle
Cucchiaione salse
Saucenkelle
Cuillère à sauce
Cuchara salsas

| art. | l. cm. | € |
|----------|--------|-------|
| 41677-00 | 32 | 16,78 |



SS

Whisk
Frusta
Schneebeesen
Fouet
Batidor

| art. | l. cm. | € |
|----------|--------|---|
| 41678-00 | 30 | - |



SS

Wall rack
Asta
Aufhängungstange
Tringle de cuisine
Asta para utensilios

| art. | l. cm. | € |
|----------|--------|-------|
| 41670-AA | 40 | 20,20 |
| 41670-AB | 60 | 28,94 |



SS

Mesh skimmer
Schiumarola a rete stirata
Schaumlöffel
Ecumoire
Espumadera

| art. | Ø cm. | l. cm. | € |
|----------|-------|--------|-------|
| 11990-16 | 16 | 40 | 20,70 |



SS

Mesh skimmer
Schiumarola a rete passabrodo
Schaumlöffel
Ecumoire
Espumadera

| art. | Ø cm. | l. cm. | € |
|----------|-------|--------|-------|
| 11991-16 | 16 | 40 | 24,52 |



SS

Bird nest fryer
Colafritto
Nestbacklöffel
Nid à friture
Molde nido

| art. | Ø cm. | l. cm. | € |
|----------|-------|--------|-------|
| 42623-10 | 10 | 26 | 16,18 |



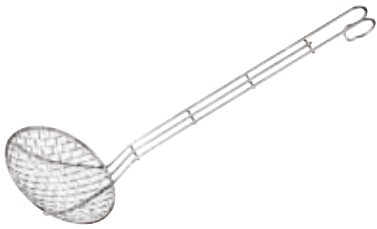

SS

Wire skimmer
Schiumarola a filo
Drahtlöffel
Araignée
Araña

| art. | Ø cm. | l. cm. | € |
|----------|-------|--------|-------|
| 12640-14 | 14 | 40 | 15,38 |
| 12640-16 | 16 | 40 | 16,68 |
| 12640-18 | 18 | 40 | 18,49 |
| 12640-20 | 20 | 50 | 24,42 |
| 12640-24 | 24 | 50 | 28,74 |
| 12640-28 | 28 | 50 | 32,76 |

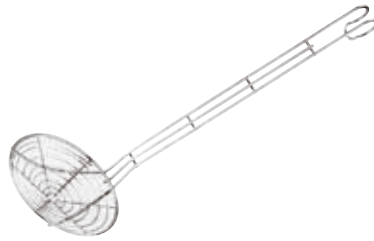

SS

Wire skimmer
Schiumarola a filo
Drahtlöffel
Araignée
Araña

| art. | Ø cm. | l. cm. | € |
|----------|-------|--------|-------|
| 12641-14 | 14 | 40 | 15,88 |
| 12641-16 | 16 | 40 | 16,78 |
| 12641-18 | 18 | 40 | 18,69 |
| 12641-20 | 20 | 50 | 24,52 |
| 12641-24 | 24 | 50 | 26,03 |
| 12641-28 | 28 | 50 | 29,15 |

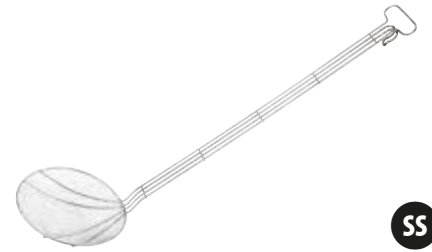

SS

Wire skimmer
Schiumarola a filo
Drahtlöffel
Araignée
Araña

| art. | Ø cm. | l. cm. | € |
|----------|-------|--------|-------|
| 12642-28 | 28 | 85 | 57,18 |



SS

French fry scoop
Pala per patate fritte
Frittenschaufel
Pelle à frites
Pala chips

| art. | cm. | € |
|----------|-----------|-------|
| 41929-00 | 20x19x6,5 | 29,85 |



ABS

French fry scoop
Pala per patate fritte
Frittenschaufel
Pelle à frites
Pala chips

| art. | cm. | € |
|----------|---------|------|
| 41929-02 | 23x20x5 | 5,13 |

Ambidextrous. – Ambidestro.



W

Spatula
Spatola
Schäber
Spatule
Espátula

| art. | l. cm. | € |
|----------|--------|-------|
| 42907-01 | 25 | 4,12 |
| 42907-02 | 30 | 4,62 |
| 42907-03 | 35 | 5,73 |
| 42907-04 | 40 | 5,93 |
| 42907-06 | 50 | 8,54 |
| 42907-07 | 60 | 10,25 |
| 42907-08 | 80 | 22,31 |
| 42907-09 | 100 | 37,19 |
| 42907-10 | 120 | 45,73 |



W

Mixing spoon
Cucchiaione
Löffel
Cuillère
Cuchara

| art. | l. cm. | € |
|----------|--------|------|
| 42901-20 | 20 | 2,41 |
| 42901-25 | 25 | 2,61 |
| 42901-30 | 30 | 3,32 |
| 42901-35 | 35 | 3,62 |
| 42901-40 | 40 | 4,22 |



W

Spatula
Spatola
Schäber
Spatule
Espátula

| art. | l. cm. | € |
|----------|--------|------|
| 42907-30 | 30 | 2,81 |
| 42907-35 | 35 | 3,22 |
| 42907-40 | 40 | 3,52 |



W

Crepe spreader, 5 pcs
Spatole crêpes, 5 pz
Crêpe-Paletten, 5 Stk
Rateau à crêpes/raclettes, 5 pcs
Espátula crêpes, 5 pz

| art. | cm. | € |
|----------|---------|-------|
| 42900-15 | 16,5x20 | 10,05 |
| 42900-24 | 18x24 | 12,26 |

Beech wood. – Faggio.



SS

Baster tube
Pompetta per sugo
Soft-Spritze
Pompe à jus
Bomba para jugo

| art. | l. cm. | € |
|----------|--------|-------|
| 42863-00 | 20 | 31,96 |



SS
PP
PS

Marinating syringe, graduated
Siringa per marinata, graduata
Marinierspritze, graduert
Seringue à marinade, graduée
Jeringa para marinar, graduada

| art. | Ø cm. | l. cm. | ml. | € |
|----------|-------|--------|-----|------|
| 42862-00 | 3,5 | 24 | 30 | 4,52 |



SS

Fish-bone remover
Pinza toglie lische
Grätenentkerner
Pince à arêtes
Pinza para espinas

| art. | l. cm. | € |
|----------|--------|-------|
| 42592-02 | 12 | 14,87 |



SS

Cooking tongs
Pinza
Kochzange
Pince
Pinza

| art. | l. cm. | € |
|----------|--------|------|
| 42904-01 | 16 | 2,71 |



SS

Cooking tongs
Pinza
Kochzange
Pince
Pinza

| art. | l. cm. | € |
|----------|--------|------|
| 42904-02 | 16 | 3,32 |



SS

Cooking tongs
Pinza
Kochzange
Pince
Pinza

| art. | l. cm. | € |
|----------|--------|------|
| 42904-03 | 15 | 3,92 |



SS

Sausage tongs
Pinza per grill
Grill-und Wurstzange
Pince à saucisses
Pinza para barbacoa

| art. | l. cm. | € |
|----------|--------|------|
| 41697-00 | 38 | 5,93 |



SS

Cooking tongs
Pinza
Kochzange
Pince
Pinza

| art. | l. cm. | € |
|----------|--------|------|
| 42902-31 | 30 | 8,64 |



SS

Cooking tongs
Pinza
Kochzange
Pince
Pinza

| art. | l. cm. | € |
|----------|--------|------|
| 42902-30 | 30 | 7,94 |





SS

Grill tweezer

Molla per grill
Grillzange
Pince à grill
Pinza para barbaçoa

| art. | l. cm. | € |
|----------|--------|------|
| 41698-22 | 22,5 | 6,53 |
| 41698-30 | 30,0 | 8,24 |
| 41698-40 | 40,0 | 8,34 |



SS

Serving tongs

Pinza a servire
Pinza a servire
Servierzange
Pince à servir
Pinza para servir

| art. | l. cm. | col. | € |
|----------|--------|------|-------|
| 42854C25 | 25 | ● | 9,15 |
| 42854C30 | 30 | ● | 10,95 |



SS

Serving tongs

Pinza a servire
Pinza a servire
Servierzange
Pince à servir
Pinza para servir

| art. | l. cm. | col. | € |
|----------|--------|------|-------|
| 42854B25 | 25 | ● | 9,15 |
| 42854B30 | 30 | ● | 10,95 |



SS

Serving tongs

Pinza a servire
Pinza a servire
Servierzange
Pince à servir
Pinza para servir

| art. | l. cm. | col. | € |
|----------|--------|------|-------|
| 42854Y25 | 25 | ○ | 9,15 |
| 42854Y30 | 30 | ○ | 10,95 |



SS

Serving tongs

Pinza a servire
Pinza a servire
Servierzange
Pince à servir
Pinza para servir

| art. | l. cm. | col. | € |
|----------|--------|------|-------|
| 42854K25 | 25 | ● | 9,15 |
| 42854K30 | 30 | ● | 10,95 |



SS

Serving tongs

Pinza a servire
Pinza a servire
Servierzange
Pince à servir
Pinza para servir

| art. | l. cm. | col. | € |
|----------|--------|------|-------|
| 42854R25 | 25 | ● | 9,15 |
| 42854R30 | 30 | ● | 10,95 |



SS

Serving tongs

Pinza a servire
Pinza a servire
Servierzange
Pince à servir
Pinza para servir

| art. | l. cm. | col. | € |
|----------|--------|------|-------|
| 42854G25 | 25 | ● | 9,15 |
| 42854G30 | 30 | ● | 10,95 |



Cooking tongs, silicone

Pinza, silicone
Kochzange aus Silikon
Pince en silicone
Pinza de silicona

| art. | l. cm. | € |
|----------|--------|------|
| 42903-29 | 29 | 6,23 |



Barbecue brush

Spazzola grill
Grill-Bürste
Brosse à grille
Cepillo para barbaçoa

| art. | cm. | l. cm. | € |
|----------|--------|--------|-------|
| 41773-00 | 5,5x11 | 27 | 12,56 |

Brass bristles. – Setole in ottone.



SS

Whisk for basin

Frusta gigante
Kesselbesen
Fouet à bassine
Batidor gigante

| art. | l. cm. | € |
|----------|--------|-------|
| 41980-99 | 125 | 90,05 |



Food-grade resin spatula

Spatola in resina alimentare
Rührspaten für Speisenzubereitung
Spatule en résine pour aliments
Espátula de resina para alimentos

| art. | cm. | l. cm. | € |
|----------|-----------|--------|--------|
| 44061-08 | 15,7x10,8 | 80 | 217,38 |
| 44061-09 | 23,5x10,8 | 90 | 220,70 |
| 44061-12 | 23,5x10,8 | 117 | 267,53 |
| 44061-14 | 23,5x10,8 | 137 | 302,71 |



SS

Speed rack

Rastrelliera
Flaschenregal
Rack à bouteilles
Rack de botellas

| art. | cm. | h. | bot. | € |
|----------|---------|------|------|-------|
| 44060-50 | 56x10,5 | 15,5 | 6 | 56,38 |
| 44060-80 | 81x10,5 | 15,5 | 8 | 88,84 |



SS

Bill spike
Spillone portascontrini
Kassenscheine-Aufstecknadel
Pique-addition
Pincha papeles

| art. | Ø cm. | h. | € |
|----------|-------|----|-------|
| 12504-20 | 9 | 20 | 15,68 |



W

Bill spike
Spillone portascontrini
Kassenscheine-Aufstecknadel
Pique-addition
Pincha papeles

| art. | cm. | l. cm. | € |
|----------|-------|--------|------|
| 42504-09 | 9x5,5 | 10,5 | 6,43 |



SS

Tickets-holder
Asta portascontrini
Bons-/Zettelhalter
Porte-fiches à billes
Barra de notas

| art. | l. cm. | € |
|----------|--------|-------|
| 42509-25 | 25 | 16,48 |
| 42509-50 | 50 | 23,22 |



SS

Tab-grabber
Asta porta scontrini
Bons-/Zettelhalter
Porte-fiches
Barra de notas

| art. | l. cm. | € |
|----------|--------|-------|
| 42509-60 | 60 | 42,11 |
| 42509-99 | 100 | 63,42 |



SS

Roll holder
Porta rotolo
Rollenhalter
Derouleur papier
Portarollos

| art. | l. cm. | € |
|----------|--------|---|
| 42512-35 | 30 | - |



SS

Wall film box
Supporto murale, porta pellicola
Wand-Folien-Abreißgerät
Dérouleur de film mural
Soporte de pared para film

| art. | l. cm. | € |
|----------|--------|--------|
| 42513-30 | 30 | 212,36 |
| 42513-45 | 45 | 253,06 |

Roll max ø cm 13. – Rotolo ø max. cm 13.



PP

Additional plate stand
Anello distanziatore
Gestell für Zusatzteller
Support assiette supplémentaire
Soporte distanciador

| art. | Ø cm. | h. | € |
|----------|-------|----|------|
| 47605-23 | 19-21 | 6 | 1,81 |



PP

Plate cover
Copripiatto
Tellerglocke
Cloche
Cubreplatos

| art. | Ø cm. | h. | € |
|----------|-------|-----|------|
| 47603-25 | 25 | 6,5 | 4,62 |
| 47603-27 | 27 | 6,5 | 5,83 |
| 44998-31 | 31 | 6,5 | 6,73 |



PC

Plate cover
Copripiatto
Tellerglocke
Cloche
Cubreplatos

| art. | Ø cm. | h. | € |
|----------|-------|-----|------|
| 44997-22 | 21 | 6,8 | 7,54 |
| 44997-24 | 23 | 6,8 | 7,84 |
| 44997-26 | 26 | 6,8 | 8,44 |
| 44997-28 | 28 | 6,8 | 8,84 |



SAN

Plate cover
Copripiatto
Tellerglocke
Cloche
Cubreplatos

| art. | Ø cm. | h. | for/per Ø | € |
|----------|-------|-----|-----------|-------|
| 44991-22 | 22,0 | 7,0 | 21,5 | - |
| 44991-24 | 24,0 | 7,5 | 22,5-23 | - |
| 44991-28 | 28,0 | 6,5 | 26-26,5 | 11,46 |
| 44991-29 | 28,5 | 6,5 | 27-27,5 | 12,56 |



SS

Plate cover
Copripiatto
Tellerglocke
Cloche
Cubreplatos

| art. | Ø cm. | h. | € |
|----------|-------|-----|-------|
| 41683-26 | 26,5 | 4,3 | 47,44 |



SS

Funnel
Imbuto
Trichter
Entonnoir
Embudo

| art. | Ø cm. | € |
|----------|-------|-------|
| 42562-12 | 12 | 19,40 |
| 42562-14 | 14 | 24,02 |
| 42562-16 | 16 | 28,84 |
| 42562-18 | 18 | 32,06 |
| 42562-20 | 20 | 38,79 |
| 42562-25 | 25 | 48,54 |
| 42562-30 | 30 | 62,51 |



PP

Funnel
Imbuto
Trichter
Entonnoir
Embudo

| art. | Ø cm. | € |
|----------|-------|------|
| 47604-08 | 8 | 1,31 |
| 47604-10 | 10 | 1,61 |
| 47604-12 | 12 | 1,91 |
| 47604-15 | 15 | 2,21 |
| 47604-18 | 18 | 4,02 |
| 47604-20 | 20 | 4,32 |
| 47604-24 | 24 | 4,82 |
| 47604-30 | 30 | 5,23 |



PP

Measuring jug
Caraffa graduata
Messbecher
Pichet gradué
Jarra de medidas

| art. | Ø cm. | h. | lt. | € |
|----------|-------|----|-----|-------|
| 47608-02 | 19 | 12 | 2,2 | 16,18 |



PP

Measuring jug
Caraffa graduata
Messbecher
Pichet gradué
Jarra de medidas

| art. | Ø cm. | h. | lt. | € |
|----------|-------|------|------|-------|
| 47606-02 | 8,5 | 10,0 | 0,25 | - |
| 47606-05 | 10,5 | 10,5 | 0,50 | 4,12 |
| 47606-10 | 12,5 | 14,5 | 1,00 | 6,03 |
| 47606-20 | 13,5 | 17,0 | 2,00 | 9,55 |
| 47606-30 | 17,0 | 23,5 | 3,00 | 12,06 |
| 47606-50 | 20,0 | 25,5 | 5,00 | 12,76 |



PP

Measuring jug
Caraffa graduata
Messbecher
Pichet gradué
Jarra de medidas

| art. | Ø cm. | h. | lt. | - | € |
|----------|-------|------|------|-----|-------|
| 47607-02 | 7 | 12,0 | 0,25 | NEW | 3,62 |
| 47607-05 | 9 | 14,0 | 0,50 | NEW | 3,92 |
| 47607-10 | 12 | 16,5 | 1 | - | 6,53 |
| 47607-20 | 15 | 20,5 | 2 | - | 12,16 |

Lt. and ml. scale. Heat resistant up to 95°C.
Scala in lt e ml. Resistente fino a 95°C.



SS

Graduated measure jug
Misurino graduato
Messbecher, graduert
Mesure graduée
Jarra de medidas

| art. | Ø cm. | h. | lt. | € |
|----------|-------|----|------|-------|
| 42581-01 | 7,5 | 5 | 0,10 | 4,72 |
| 42581-03 | 10,0 | 7 | 0,25 | 7,64 |
| 42581-05 | 11,5 | 11 | 0,50 | 12,76 |
| 42581-10 | 15,0 | 13 | 1,00 | 17,69 |
| 42581-15 | 15,5 | 15 | 1,50 | 29,55 |
| 42581-20 | 17 | 19 | 2,00 | 33,97 |



SS

Measuring spoons, 4 pcs
Misurini set 4 pz
Messlöffel Set 4-tlg.
Cuillères à mesurer 4 pcs
Cucharas medidoras 4 pz

| art. | ml. | € |
|----------|------------|-------|
| 42615-04 | 1-2,5-5-15 | 11,16 |



SS

Measuring cups, 4 pcs
Misurini set 4 pz
Messlöffel Set 4-tlg.
Cuillères à mesurer 4 pcs
Cucharas medidoras 4 pz

| art. | ml. | € |
|----------|---------------|-------|
| 42616-04 | 60-80-125-250 | 26,53 |



SS

Lever dispenser
 Dosatore
 Hebeldosierspender
 Distributeur à manette
 Dispensador

| art. | Ø cm. | h. | € |
|----------|-------|------|--------|
| 41528-21 | 21 | 22,5 | 216,18 |
| 41528-22 | 22 | 18,0 | 216,18 |

Suitable for 5 kg bucket. – Per bidone da kg 5.



AY

Dispenser
 Dosatore
 Dosierspender
 Doseur
 Dispensador

| art. | ml. | € |
|----------|------|-------|
| 47609-02 | 250 | 31,36 |
| 47609-03 | 350 | 33,17 |
| 47609-09 | 950 | 47,03 |
| 47609-13 | 1350 | 52,36 |



AY

Dispenser
 Dosatore
 Dosierspender
 Doseur
 Dispensador

| art. | ml. | € |
|----------|------|-------|
| 47609-04 | 375 | - |
| 47609-07 | 750 | - |
| 47609-12 | 1250 | 49,95 |
| 47609-16 | 1650 | 59,40 |



PE

Squeeze bottle
 Flacone dosatore
 Quetschflasche
 Flacon doseur
 Frasco dosificador

| art. | ml. | col. | € |
|----------|-----|------|------|
| 41526-R1 | 240 | ● | 1,11 |
| 41526-R2 | 360 | ● | 1,31 |
| 41526-R3 | 720 | ● | 1,71 |



PE

Squeeze bottle
 Flacone dosatore
 Quetschflasche
 Flacon doseur
 Frasco dosificador

| art. | ml. | col. | € |
|----------|-----|------|------|
| 41526-B1 | 240 | ○ | 1,11 |
| 41526-B2 | 360 | ○ | 1,31 |
| 41526-B3 | 720 | ○ | 1,71 |



PE

Squeeze bottle
 Flacone dosatore
 Quetschflasche
 Flacon doseur
 Frasco dosificador

| art. | ml. | col. | € |
|----------|-----|------|------|
| 41526-G1 | 240 | ● | 1,11 |
| 41526-G2 | 360 | ● | 1,31 |
| 41526-G3 | 720 | ● | 1,71 |



PE

Squeeze bottle, 4 pcs
 Flacone dosatore, 4 pz
 Quetschflasche, 4 Stk
 Flacon doseur, 4 pcs
 Frasco dosificador, 4 pz

| art. | Ø cm. | h. | ml. | € |
|----------|-------|-----|-----|------|
| 41526-01 | 3 | 8,5 | 30 | 9,25 |



PE

Squeeze bottle, 4 pcs
 Flacone dosatore, 4 pz
 Quetschflasche, 4 Stk
 Flacon doseur, 4 pcs
 Frasco dosificador, 4 pz

| art. | Ø cm. | h. | ml. | € |
|----------|-------|-----|-----|------|
| 41526-02 | 3,5 | 9,5 | 50 | 9,95 |



PE

Squeeze bottle
 Flacone dosatore
 Quetschflasche
 Flacon doseur
 Frasco dosificador

| art. | Ø cm. | h. | ml. | € |
|----------|-------|----|-----|------|
| 41526-05 | 5,0 | 18 | 200 | 2,51 |
| 41526-06 | 5,5 | 19 | 350 | 4,12 |



PE

Triple nozzle squeeze bottle

Flacone dosatore, triplo ugello
Quetschflasche mit Dreifachdüse
Flacon doseur à trois becs
Frasco dosificador 3 boquillas

| art. | ml. | col. | € |
|----------|-----|------|------|
| 41520-08 | 235 | ○ | 1,61 |
| 41520-12 | 355 | ○ | 1,81 |
| 41520-16 | 470 | ○ | 2,01 |
| 41520-24 | 700 | ○ | 2,11 |



SS

Decorating spoons 2 pcs

Cucchiai decorazione 2 pz
Dekoration-Löffel 2 Stk
Cuillères pour décorer 2 pcs
Cucharas para decoración 2 pz

| art. | l. cm. | € |
|----------|--------|-------|
| 47831-02 | 18-20 | 10,15 |

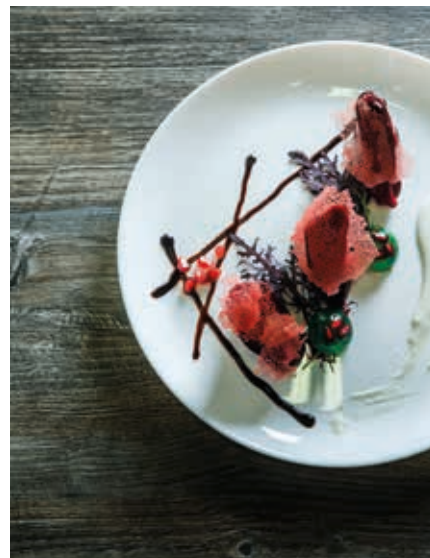

SS

Flour scoop

Sessola tonda
Mehlschaufel
Pelle à farine
Librador

| art. | lt. | € |
|----------|------|-------|
| 42609-10 | 0,10 | 21,91 |
| 42609-15 | 0,40 | 25,02 |
| 42609-20 | 1,00 | 29,35 |
| 42609-23 | 1,70 | 32,46 |
| 42609-25 | 2,80 | 49,95 |



PP

Flour scoop

Sessola
Mehlschaufel
Pelle à farine
Librador

| art. | cm. | lt. | € |
|----------|----------|------|------|
| 17610-01 | 20x7 | 0,10 | 2,71 |
| 17610-02 | 27,5x9,5 | 0,25 | 2,91 |
| 17610-05 | 32,5x12 | 0,50 | 3,82 |
| 17610-10 | 39x15 | 1,00 | 5,53 |



**PA+
plus**

Flour scoop

Sessola
Mehlschaufel
Pelle à farine
Librador

| art. | cm. | lt. | € |
|----------|----------|------|-------|
| 12940-02 | 27,5x9,5 | 0,25 | 6,23 |
| 12940-05 | 32,5x12 | 0,50 | 8,54 |
| 12940-10 | 39x15 | 1,00 | 12,06 |
| 12940-20 | 48x18 | 2,00 | 26,93 |
| 12940-25 | 50x19,5 | 2,50 | 30,35 |



SS

Bread sieve

Setaccio pane
Brotsieb
Tamis à pain
Cernidor para pan

| art. | Ø cm. | h. | € |
|----------|-------|-----|-------|
| 12604-22 | 22 | 6,5 | 27,44 |
| 12604-30 | 30 | 6,5 | 35,98 |
| 12604-34 | 34 | 6,5 | 43,62 |
| 12604-40 | 40 | 6,5 | 53,16 |

8 eye per inch. – 8 fori per 2,5 cm2.



SS

Flour sieve

Setaccio farina
Mehlsieb
Tamis à farine
Cernidor para harina

| art. | Ø cm. | h. | € |
|----------|-------|-----|-------|
| 12605-22 | 22 | 6,5 | 26,63 |
| 12605-30 | 30 | 6,5 | 34,47 |
| 12605-34 | 34 | 6,5 | 41,21 |
| 12605-40 | 40 | 6,5 | 50,85 |

20 eye per inch. – 20 fori per 2,5 cm2.



SS

Sieve

Setaccio infarina pesce
Sieb
Tamis
Cernidor

| art. | Ø cm. | h. | € |
|----------|-------|-----|-------|
| 12606-30 | 30 | 6,5 | 41,10 |
| 12606-34 | 34 | 6,5 | 49,85 |

4 eye per inch. – 4 fori per 2,5 cm2.



SS

Sieve

Setaccio rete pasticciere

Sieb

Tamis

Cernidor

| art. | Ø cm. | h. | € |
|----------|-------|-----|-------|
| 12607-22 | 22 | 6,5 | 27,44 |
| 12607-30 | 30 | 6,5 | 35,98 |
| 12607-34 | 34 | 6,5 | 43,62 |

10 eye per inch. – 10 fori per 2,5 cm2.



SS

Kitchenbowl, with handles

Bacinella conica con maniglie

Schüssel mit Griffen

Bassine conique avec anses

Caldero cónico con asas

| art. | Ø cm. | h. | lt. | € |
|----------|-------|------|------|--------|
| 11955-32 | 32 | 16,0 | 8,8 | 95,58 |
| 11955-36 | 36 | 18,5 | 12,8 | 105,63 |
| 11955-40 | 40 | 20,0 | 17,0 | 120,00 |
| 11955-45 | 45 | 22,5 | 24,5 | 135,68 |
| 11955-50 | 50 | 24,0 | 32,5 | 163,11 |



SS

Conical colander

Colapasta tronco conico

Gemüsesieher

Passoire à légumes

Colador cónico

| art. | Ø cm. | h. | lt. | € |
|----------|-------|------|------|--------|
| 11930-24 | 24 | 12,0 | 3,5 | 85,43 |
| 11930-28 | 28 | 14,0 | 5,5 | 89,85 |
| 11930-32 | 32 | 16,0 | 8,8 | 101,71 |
| 11930-36 | 36 | 18,5 | 12,8 | 114,57 |
| 11930-40 | 40 | 20,0 | 17,0 | 130,55 |
| 11930-45 | 45 | 22,5 | 24,5 | 144,42 |
| 11930-50 | 50 | 24,0 | 32,5 | 175,98 |



SS

Conical colander

Colapasta tronco conico

Gemüsesieher

Passoire à légumes

Colador cónico

| art. | Ø cm. | h. | lt. | € |
|----------|-------|------|------|--------|
| 11927-24 | 24 | 12,0 | 3,5 | 97,69 |
| 11927-28 | 28 | 14,0 | 5,5 | 107,03 |
| 11927-32 | 32 | 16,0 | 8,8 | 123,82 |
| 11927-36 | 36 | 18,5 | 12,8 | 139,59 |
| 11927-40 | 40 | 20,0 | 17,0 | 157,38 |
| 11927-45 | 45 | 22,5 | 24,5 | 183,11 |
| 11927-50 | 50 | 24,0 | 32,5 | 219,39 |



SS

Hemispherical mixing bowl

Bacinella emisferica

Schüssel

Bassine demi-ronde

Caldero semiesférico

| art. | Ø cm. | lt. | € |
|----------|-------|------|-------|
| 11957-20 | 20 | 2,0 | 32,66 |
| 11957-25 | 25 | 3,7 | 39,30 |
| 11957-30 | 30 | 7,2 | 48,94 |
| 11957-35 | 35 | 10,5 | 59,60 |
| 11957-40 | 40 | 15,6 | 67,84 |



NSF

SS

Kitchenbowl low

Bacinella conica bassa

Schüssel, flach

Bassine

Caldero cónico

| art. | Ø cm. | h. | lt. | € |
|----------|-------|------|------|-------|
| 12582-13 | 13,2 | 6,0 | 0,5 | 11,06 |
| 12582-17 | 16,5 | 7,5 | 1,0 | 14,87 |
| 12582-22 | 22,0 | 7,5 | 2,0 | 21,61 |
| 12582-24 | 24,0 | 9,5 | 3,0 | 24,72 |
| 12582-32 | 30,5 | 11,5 | 6,0 | 39,70 |
| 12582-34 | 32,5 | 14,0 | 8,0 | 44,02 |
| 12582-38 | 38,0 | 13,5 | 11,0 | 62,61 |
| 12582-40 | 40,0 | 15,0 | 14,0 | 69,55 |



NSF

SS

Kitchenbowl high

Bacinella conica alta

Tiefe Schüssel

Bassine haute

Caldero cónico alto

| art. | Ø cm. | h. | lt. | € |
|----------|-------|------|------|--------|
| 12580-11 | 11,7 | 7,0 | 0,5 | 10,15 |
| 12580-17 | 15,5 | 9,0 | 1,0 | 13,17 |
| 12580-21 | 19,0 | 11,5 | 2,0 | 17,59 |
| 12580-24 | 22,0 | 12,0 | 3,0 | 23,32 |
| 12580-29 | 27,0 | 13,5 | 5,0 | 33,06 |
| 12580-30 | 29,0 | 15,0 | 6,0 | 35,98 |
| 12580-31 | 30,5 | 17,0 | 8,0 | 42,61 |
| 12580-36 | 35,5 | 18,5 | 11,0 | 60,80 |
| 12580-40 | 40,0 | 20,0 | 17,0 | 98,29 |
| 12580-45 | 45,0 | 22,0 | 25,0 | 114,87 |
| 12580-50 | 50,0 | 24,0 | 33,0 | 143,82 |



Conical colander, aluminium

Colapasta tronco conico, alluminio

Gemüsesieher, Aluminium

Passoire à légumes, alu

Colador cónico, aluminio

| art. | Ø cm. | h. | lt. | € |
|----------|-------|------|------|--------|
| 16927-32 | 32 | 16,0 | 8,8 | 68,64 |
| 16927-36 | 36 | 18,5 | 12,8 | 81,30 |
| 16927-40 | 40 | 20,0 | 17,0 | - |
| 16927-45 | 45 | 22,5 | 24,5 | 132,06 |
| 16927-50 | 50 | 24,0 | 32,5 | 145,73 |



SS

Colander

Colapasta con cerchio

Gemüsesieher

Passoire à légumes

Colador con base

| art. | Ø cm. | h. | lt. | € |
|----------|-------|------|------|--------|
| 11928-32 | 32 | 18,0 | 9,5 | 128,84 |
| 11928-36 | 36 | 19,0 | 12,0 | 156,48 |
| 11928-40 | 40 | 21,0 | 14,5 | 186,83 |



SS

Strainer

Colapasta semisferico
Stielsieb
Passoire hémispherique
Colador semiesférico

| art. | Ø cm. | h. | lt. | € |
|----------|-------|----|-----|-------|
| 11926-22 | 22 | 12 | 2,7 | 59,70 |
| 11926-26 | 26 | 14 | 4,0 | 68,64 |



SS

Strainer

Colapasta
Stielsieb
Passoire
Colador

| art. | Ø cm. | h. | lt. | € |
|----------|-------|----|-----|-------|
| 11924-18 | 18 | 11 | 2,8 | 49,65 |
| 11924-20 | 20 | 12 | 3,6 | 54,07 |
| 11924-22 | 22 | 13 | 5,0 | 59,90 |
| 11924-24 | 24 | 14 | 6,5 | 68,34 |
| 11924-28 | 28 | 15 | 9,3 | 85,63 |



Strainer, aluminium

Colapasta, alluminio
Stielsieb, Aluminium
Passoire, alu
Colador, aluminio

| art. | Ø cm. | h. | lt. | € |
|----------|-------|----|-----|---|
| 16924-20 | 20 | 11 | 3,2 | - |
| 16924-24 | 24 | 13 | 6,0 | - |
| 16924-28 | 28 | 15 | 9,3 | - |



PP

Strainer

Colapasta
Stielsieb
Passoire
Colador

| art. | Ø cm. | € |
|----------|-------|------|
| 47610-22 | 22 | 2,91 |
| 47610-26 | 26 | 3,52 |
| 47610-30 | 30 | 3,92 |



PP

Strainer

Colapasta
Stielsieb
Passoire
Colador

| art. | Ø cm. | € |
|----------|-------|------|
| 47610-18 | 18 | 2,61 |



PE

Graduated bucket

Secchio graduato
Eimer mit Skala
Seau gradué
Cubo con medidas

| art. | Ø cm. | h. | lt. | € |
|----------|-------|------|-----|-------|
| 49889-09 | 27 | 26,2 | 9 | 7,74 |
| 49889-12 | 29 | 29,0 | 12 | 9,15 |
| 49889-15 | 31 | 30,8 | 15 | 11,06 |

With spout. – Con becco.



SS

Graduated bucket

Secchio graduato
Eimer mit Skala
Seau gradué
Cubo con medidas

| art. | Ø cm. | h. | lt. | € |
|----------|-------|------|-----|-------|
| 41960-08 | 28,5 | 20,5 | 8 | 71,25 |
| 41960-10 | 30,0 | 25,0 | 10 | 77,08 |
| 41960-12 | 31,0 | 27,0 | 12 | 87,03 |
| 41960-15 | 32,5 | 31,0 | 15 | 94,27 |



SS

Graduated bucket with bottom ring

Secchio graduato con base
Eimer mit Fuss u. Skala
Seau gradué avec base
Cubo con medidas y base

| art. | Ø cm. | h. | lt. | € |
|----------|-------|------|-----|--------|
| 41961-10 | 30,0 | 26,5 | 10 | 109,04 |
| 41961-12 | 31,0 | 28,5 | 12 | 119,09 |
| 41961-15 | 32,5 | 32,5 | 15 | 126,13 |



SS

Lid for bucket
Coperchio per secchio
Deckel für Eimer
Couvercle pour seau
Tapa para cubo

| art. | Ø cm. | € |
|----------|-------|-------|
| 41962-10 | 30,0 | 29,55 |
| 41962-12 | 31,0 | 32,56 |
| 41962-15 | 32,5 | 37,19 |



PP

Mixing bowl
Bacinella tonda
Schüssel
Bassine ronde
Caldero semiesférico

| art. | Ø cm. | h. | lt. | € |
|----------|-------|------|------|-------|
| 47611-01 | 19,0 | 7,9 | 1,0 | 7,24 |
| 47611-03 | 24,0 | 11,5 | 2,5 | 9,55 |
| 47611-05 | 28,0 | 13,5 | 4,5 | 11,26 |
| 47611-06 | 32,5 | 14,7 | 6,0 | 15,48 |
| 47611-09 | 36,0 | 16,5 | 9,0 | 18,19 |
| 47611-13 | 40,0 | 18,5 | 13,0 | 24,32 |



PP

Lid
Coperchio
Deckel
Couvercle
Tapa

| art. | Ø cm. | € |
|----------|-------|-------|
| 47611-11 | 19,0 | 3,12 |
| 47611-14 | 24,0 | 5,23 |
| 47611-15 | 28,0 | 6,53 |
| 47611-16 | 32,5 | 8,04 |
| 47611-19 | 36,0 | 11,26 |
| 47611-23 | 40,0 | 11,56 |



PP

Mixing bowl
Bacinella tonda
Schüssel
Bassine ronde
Caldero semiesférico

| art. | Ø cm. | h. | lt. | € |
|----------|-------|------|------|-------|
| 47600-16 | 16 | 7,0 | 0,9 | 3,92 |
| 47600-20 | 20 | 8,5 | 1,6 | 6,43 |
| 47600-24 | 24 | 10,0 | 2,8 | 7,54 |
| 47600-28 | 28 | 11,0 | 4,5 | 12,76 |
| 47600-32 | 32 | 12,5 | 6,5 | 16,08 |
| 47600-36 | 36 | 14,0 | 10,0 | 17,09 |
| 47600-40 | 40 | 15,5 | 13,5 | 18,09 |



PP

Mixing bowl
Bacinella semisferica
Schüssel
Bassine hémispherique
Caldero semiesférico

| art. | Ø cm. | h. | lt. | € |
|----------|-------|------|------|------|
| 44365-04 | 13,0 | 6,5 | 0,4 | 1,41 |
| 44365-10 | 17,0 | 8,5 | 1,0 | 1,81 |
| 44365-25 | 23,5 | 11,0 | 2,5 | 2,91 |
| 44365-40 | 28,0 | 14,5 | 4,0 | 3,92 |
| 44365-80 | 32,5 | 16,5 | 8,0 | 4,82 |
| 44365-99 | 38,0 | 18,0 | 10,0 | 7,14 |



PC

Mixing bowl
Bacinella semisferica
Schüssel
Bassine hémispherique
Caldero semiesférico

| art. | Ø cm. | h. | lt. | € |
|----------|-------|------|------|-------|
| 44364-04 | 13,0 | 6,5 | 0,4 | 2,81 |
| 44364-10 | 17,0 | 8,5 | 1,0 | 4,32 |
| 44364-25 | 23,5 | 11,0 | 2,5 | 7,84 |
| 44364-40 | 28,0 | 14,5 | 4,0 | 10,75 |
| 44364-80 | 32,5 | 16,5 | 8,0 | 15,78 |
| 44364-99 | 38,0 | 18,0 | 10,0 | 23,72 |



SS

Mixing bowl
Bastardella semisferica
Schneeschlagkessel
Bassine hémispherique
Caldero con asas

| art. | Ø cm. | h. | lt. | € |
|----------|-------|------|------|--------|
| 11952-22 | 22 | 12,0 | 2,7 | 44,72 |
| 11952-26 | 26 | 14,0 | 4,0 | 58,19 |
| 11952-32 | 32 | 18,0 | 9,5 | 74,67 |
| 11952-36 | 36 | 20,5 | 14,0 | 111,96 |
| 11952-40 | 40 | 21,5 | 18,0 | 118,09 |



SS

Mixing bowl without handles
Bastardella senza maniglie
Schneeschlagkessel ohne Griffe
Bassine hémispherique sans anses
Caldero sin asas

| art. | Ø cm. | h. | lt. | € |
|----------|-------|------|------|--------|
| 11951-22 | 22 | 12,0 | 2,7 | 36,78 |
| 11951-26 | 26 | 14,0 | 4,0 | 49,85 |
| 11951-32 | 32 | 18,0 | 9,5 | 65,93 |
| 11951-36 | 36 | 20,5 | 14,0 | 94,57 |
| 11951-40 | 40 | 21,5 | 18,0 | 109,55 |



SS

Foot for mixing bowl

Base per bastardella
Fuss für Schneeschlagkessel
Base pour bassine hémispherique
Base para caldero

| art. | Ø cm. | for/per Ø | € |
|----------|-------|-----------|-------|
| 11953-16 | 16 | 22-26 | 25,02 |
| 11953-22 | 22 | 32-36-40 | 31,76 |



SS

Kettle for mixing machines

Bacinella per planetaria
Schlagmaschinenkessel
Bol pour mélangeurs
Caldero para batidera

| art. | Ø cm. | h. | lt. | € |
|----------|-------|------|------|--------|
| 11954-26 | 26 | 20,0 | 10,0 | 107,94 |
| 11954-30 | 30 | 25,0 | 16,0 | 119,80 |
| 11954-32 | 32 | 30,0 | 20,0 | 148,54 |
| 11954-36 | 36 | 28,5 | 25,0 | 172,06 |
| 11954-37 | 36 | 35,0 | 32,0 | 187,63 |
| 11954-40 | 40 | 35,5 | 40,0 | 213,46 |



SS

Kitchenbowl with handle

Tazzone con manico
Schlagschüssel mit Rohrstiel
Bol avec manche
Cazo bombeado

| art. | Ø cm. | h. | lt. | € |
|----------|-------|------|-----|-------|
| 41916-10 | 15 | 8,0 | 1,0 | 37,08 |
| 41916-15 | 17 | 9,0 | 1,2 | 43,01 |
| 41916-20 | 19 | 10,0 | 2,0 | 47,03 |



Induction adapter

Adattatore induzione
Induktion Adapterplatte
Disque relais pour induction
Adaptador para inducción

| art. | Ø cm. | € |
|----------|-------|-------|
| 41922-16 | 16 | 31,56 |
| 41922-22 | 20 | 38,89 |

Removable handle in heat resistant material.
Manico estraibile in materiale termo resistente.



Manual salad spinner

Centrifuga manuale per verdura
Salatschleuder
Essoreuse manuelle à salade
Centrifugadora de ensalada

| art. | Ø cm. | h. | lt. | € |
|----------|-------|----|-----|--------|
| 49888-10 | 33 | 43 | 12 | 117,99 |
| 49888-20 | 43 | 52 | 25 | 125,32 |



SS

Soup strainer

Colino a rete
Suppensieb
Passe-bouillon
Colador a red

| art. | Ø cm. | l. cm. | € |
|----------|-------|--------|-------|
| 12622-07 | 7 | 12 | 4,42 |
| 12622-10 | 10 | 12 | 6,43 |
| 12622-12 | 12 | 17 | 7,04 |
| 12622-14 | 14 | 17 | 8,54 |
| 12622-16 | 16 | 17 | 10,55 |
| 12622-18 | 18 | 17 | 12,26 |
| 12622-20 | 20 | 17 | 12,36 |
| 12622-23 | 23 | 27 | 20,30 |
| 12622-26 | 26 | 27 | 28,04 |



SS

Strainer, double mesh

Colapasta doppia rete
Passiersieb, doppelnetz
Passoire, maille double
Colador doble red

| art. | Ø cm. | l. cm. | € |
|----------|-------|--------|-------|
| 12633-16 | 16 | 17 | 12,86 |
| 12633-18 | 18 | 17 | 13,87 |
| 12633-20 | 20 | 17 | 15,28 |
| 12633-23 | 23 | 27 | 21,31 |
| 12633-26 | 26 | 27 | 29,15 |



SS

Strainer

Colatutto
Sieb
Passoire
Colador multiuo

| art. | cm. | l. cm. | € |
|----------|-------|--------|-------|
| 12630-22 | 22x18 | 19 | 16,88 |





SS

Strainer

Colino
Sieb
Passoire
Colador

| art. | Ø cm. | € |
|----------|-------|------|
| 41570-10 | 8 | 6,03 |



SS

Strainer, reinforced

Colapasta rinforzato
Grossküchensieb mit Verstärkung
Passoire renforcé
Colador reforzado

| art. | Ø cm. | l. cm. | € |
|----------|-------|--------|-------|
| 12635-23 | 23 | 27 | 34,57 |
| 12635-26 | 26 | 27 | 38,69 |
| 12635-30 | 30 | 44 | 53,77 |
| 12635-35 | 35 | 44 | 60,80 |



SS

Strainer

Colatutto gigante
Grossküchensieb
Passoire géant
Colador multiuso gigante

| art. | Ø cm. | l. cm. | € |
|----------|-------|--------|-------|
| 12636-32 | 32 | 40 | 60,80 |



SS

Chinese colander

Cornetto cinese
Spitzsieb
Passoire chinois
Colador chino

| art. | Ø cm. | € |
|----------|-------|-------|
| 41925-14 | 14 | 18,89 |
| 41925-16 | 16 | 29,45 |
| 41925-18 | 18 | 30,05 |
| 41925-20 | 20 | 31,26 |
| 41925-22 | 22 | 36,18 |
| 41925-24 | 24 | 45,23 |
| 41925-26 | 26 | 50,75 |



SS

Chinese colander stand

Supporto per cornetto cinese
Träger für Spitzsieb
Support chinois
Soporte para colador chino

| art. | Ø cm. | h. | € |
|----------|-------|----|-------|
| 41933-18 | 18 | 28 | 17,59 |



SS

Colander with wire gauze

Cornetto cinese a rete
Gazensieb
Chinois à gaze
Colador chino a red

| art. | Ø cm. | € |
|----------|-------|-------|
| 11929-20 | 20 | 37,19 |
| 11929-24 | 24 | 42,51 |



SS

Chinese colander with wire protection

Cornetto con protezione
Spitzsieb mit Verstärkung
Chinois à gaze avec renfort
Colador chino con protección

| art. | Ø cm. | € |
|----------|-------|-------|
| 11932-20 | 20 | 42,61 |
| 11932-24 | 24 | 50,85 |



SS

Soup strainer

Colino a rete
Suppen
Passe-bouillon
Colador a red

| art. | Ø cm. | € |
|----------|-------|-------|
| 41931-08 | 8,5 | 6,93 |
| 41931-14 | 14,0 | 11,56 |
| 41931-16 | 15,0 | 14,07 |
| 41931-18 | 19,0 | 18,69 |



Bouillon cloth

Panno passabrodo
Bouillonstoffsieb
Etamine passe-bouillon
Paño para pasar caldo

| art. | cm. | U. Pack | € |
|----------|-------|---------|------|
| 41932-05 | 87x70 | 5 | 9,05 |

Twisted cotton cloth with seam.
Tela di cotone ritorto, orlata.



Foodloops, silicone, 6 pcs

Laccetti da cucina, silicone, 6 pz
Silikonbänder, 6 Stk
Lacets de cuisson, silicone, 6 pcs
Lazos de silicona de cocina, 6 pz

| art. | l. cm. | € |
|----------|--------|------|
| 41595B44 | 22 | 6,23 |
| 41595B45 | 53 | 8,94 |



Presse canard, bronzo

Presse canard, bronzo
Presse canard, Bronze
Presse à canard, bronze
Prensador para canard, bronzo

| art. | h. | Kg. | € |
|----------|----|-----|----------|
| 49845-01 | 52 | 16 | 5.865,38 |

Tinned. – Stagnato.



Octopus-press

Pressapolipo
Krake-Press
Presse à poulpe
Prensador para pulpo

| art. | Ø cm. | h. | € |
|----------|-------|------|--------|
| 49760-00 | 10,5 | 20,5 | 595,06 |



Tomato cutter

Affetta pomodori
Tomatenschneidergerät
Coupe-tomates
Cortador tomates

| art. | cm. | Kg. | € |
|----------|----------|-----|--------|
| 49837-05 | 30x14x18 | 2 | 492,15 |

Slice thickness 5,5 mm. – Spessore taglio 5,5 mm.

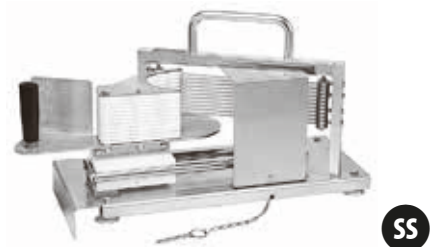

Mozzarella/tomato cutter

Affetta mozzarella/pomodori
Mozzarella-/Tomatenschneidergerät
Coupe-mozzarella/tomates
Cortador mozzarella/tomates

| art. | cm. | Kg. | € |
|----------|----------|-----|--------|
| 49820-05 | 48x20x32 | 7,1 | 814,55 |

Also suitable for cutting lemons, oranges or kiwis, etc. Slice thickness 5,5 mm.
Adatto anche per tagliare limoni, arance o kiwi, ecc. Spessore fetta 5,5 mm.





SS

Cube cutter
Taglia cubi
Würfel-Schneidgerät
Coupe-cubes
Cortador en dados

| art. | cm. | Kg. | € |
|----------|------------|-----|--------|
| 49821-08 | 35,5x26x66 | 4 | 754,65 |

Dice thickness 8 mm. – Spessore taglio 8 mm.



SS

Vegetable cutter
Taglia verdure
Gemüseschneider
Machine à tourner les légumes
Cortador de verduras

| art. | cm. | Kg. | € |
|----------|------------|-----|--------|
| 49842-00 | 21x17,5x19 | 3,2 | 910,23 |

To make chateau potatoes, cocottes and fondants lenght from 4 to 8 cm. 3 position adjustable blade. – Per patate chateau, cocotte e fondenti di lunghezza da 4 a 8 cm. Lama con 3 regolazioni. di taglio.



SS

Pineapple coring tool
Svuota ananas
Ananasausstecher
Vide ananas
Saca corazón de piña

| art. | Ø cm. | l. cm. | € |
|----------|-------|--------|------|
| 48280-10 | 2,5 | 24 | 7,54 |



SS

Pineapple slicer
Taglia ananas
Ananasteiler
Coupe-ananas en rondelle
Cortador de piña en rondajas

| art. | Ø cm. | l. cm. | € |
|----------|-------|--------|-------|
| 48218-00 | 2,5 | 24 | 45,63 |



SS

Pineapple-peeler/corer
Pela/svuota ananas
Ananasschälmaschine
Epluche-ananas
Pelador de piña

| art. | cm. | Kg. | € |
|----------|----------|-----|----------|
| 49818-00 | 45x39x72 | 18 | 1.729,40 |

Blade and pusher Ø 89 mm.
Lama e pressatore Ø 89 mm.



Additional pushers and blades
Pressatori e lame opzionali
Zusätzliche Presse und Messer
Poussoirs et couteaux supplémentaires
Empujador y cuchilla suplementarios

| art. | des. | Ø cm. | € |
|----------|------------|-------|--------|
| 49818-AC | blade/lama | 7,4 | 199,59 |
| 49818-AD | pusher | 7,4 | 162,81 |
| 49818-AE | blade/lama | 10,2 | 194,47 |
| 49818-AF | pusher | 10,2 | 170,35 |



SS

Fruit cutter
Trancia spicchi
Früchteschneider
Coupe-fruits
Cortador tomates

| art. | cm. | Kg. | € |
|----------|----------|-----|--------|
| 49838-08 | 38x26x58 | 3,3 | 353,26 |

8 wedges, for vegetables and fruits without stone. – 8 spicchi, per ortaggi e frutta senza nocciolo.



SS

Apple corer/wedger set of blades
Set lame levatorisolo e trancia spicchi
Apfelentkerner-/Schneidmesser
Lames évideur/coupe-pommes
Saca corazón y cortador para manzanas

| art. | € |
|----------|--------|
| 49838-98 | 130,35 |

8 sections. – 8 sezioni.



Electric peeler

Pelatrice elettrica
Elektr. Schälmaschine
Eplucheur électrique
Pelador eléctrico

| art. | cm. | Kg. | € |
|----------|------------|-----|--------|
| 49750-00 | 25x16x21,5 | 2 | 533,96 |



Professional apple peeler "KALI"

Pela mele professionale
Profi-Apfelschäler
Pèle-pommes, professionnel
Pelador de manzanas, profesional

| art. | cm. | Kg. | € |
|----------|----------|-----|--------|
| 49834-00 | 32x14x10 | 1,9 | 711,04 |



Apple peeler with screw

Pela mele con morsetto
Apfelschäler, Tischklemme
Pèle-pommes, socle serre-joint
Pelador de manzanas, fijación brida

| art. | cm. | € |
|----------|----------|-------|
| 49835-00 | 30x10x17 | 47,13 |



Apple peeler, vacuum-power base

Pela mele con ventosa
Apfelschäler, Vakuum-Fuss
Pèle-pommes, socle vacuum
Pelador de manzanas, fijación ventosa

| art. | cm. | € |
|----------|----------|-------|
| 49836-00 | 30x10x13 | 48,04 |



SS

Apple corer/wedger

Trancia spicchi per mela
Apfelentkerner-/Schneider
Lames évident/coupe-pommes
Cortador y descorazonador manzanas

| art. | Ø cm. | € |
|----------|-------|-------|
| 48289-10 | 10 | 17,29 |



SS

Egg wedger

Taglia uova
Eierteiler
Tranche-oeufs
Cortahuevos

| art. | Ø cm. | l. cm. | € |
|----------|-------|--------|-------|
| 42597-00 | 6,5 | 21 | 10,55 |



SS

Egg top cutter

Apriuovo
Eierköpfer
Toque oeuf
Abridor de huevos

| art. | Ø cm. | h. | € |
|----------|-------|----|-------|
| 42595-01 | 3,5 | 15 | 27,74 |

To quickly and accurately remove the top of raw or soft-boiled eggs. – Per rimuovere in modo rapido e preciso la parte superiore delle uova crude o alla coque.



Egg slicer, aluminum

Taglia uova, alluminio
Eierteiler, Aluminium
Tranche-oeufs rondelle, aluminium
Cortahuevos guitarra, aluminio

| art. | cm. | € |
|----------|------------|-------|
| 42588-01 | 13,5x8x4,5 | 13,07 |



Egg slicer duo

Taglia uova doppio
Eierteiler 2 in 1
Tranche-oeufs 2 emplacements
Cortahuevos doble

| art. | cm. | € |
|----------|----------|------|
| 42588-00 | 21x8x4,5 | 8,54 |



Egg container

Contenitore per uova
Eier-Behälter
Porte-oeufs
Contenedor para huevos

| art. | cm. | € |
|----------|-------------|-------|
| 47093-24 | 30x21,5x6,5 | 54,47 |



SS

Egg rings 2 pcs

Anelli per uova 2 pz
Eierreinge, 2 Stk
Ronds à oeufs, 2 pcs
Anillos para huevos, 2 pz

| art. | Ø cm. | h. | € |
|----------|-------|-----|------|
| 42596-02 | 8 | 1,5 | 2,41 |



Egg ring, non stick

Anello per uova, antiaderente
Eierring, beschichtet
Rond à oeufs, anti-adhésif
Anillo para huevos, antiadherente

| art. | Ø cm. | h. | € |
|----------|-------|-----|------|
| 42650-10 | 10 | 1,5 | 4,42 |



Egg ring, non stick

Anello per uova, antiaderente
Eierring, beschichtet
Rond à oeufs, anti-adhésif
Anillo para huevos, antiadherente

| art. | Ø cm. | h. | € |
|----------|-------|-----|------|
| 42650-11 | 11 | 1,5 | 4,72 |



Artichoke corer

Svuota carciofi
Artischocken Entkerner
Etrogneur à artichauts
Saca corazon para alcachofas

| art. | Ø cm. | h. | € |
|----------|-------|----|------|
| 48288-02 | 8 | 8 | 8,84 |

Top-rack dishwasher-safe. ABS body and scoop, PP cover, stainless steel blade. – Lavabile in lavastoviglie nel cestello superiore. Corpo e palette in ABS, coperchio in PP, lama inox.



Brussel sprout cutter

Taglia cavolini di Bruxelles
Rosenkohl-Schneider
Coupe-choux de Bruxelles
Cortador de coles de Bruselas

| art. | cm. | € |
|----------|--------|------|
| 48288-03 | 8x8x10 | 8,54 |

Dishwasher safe. SAN transparent body, ABS frame, PP base, stainless steel blade. – Lavabile in lavastoviglie. Corpo trasparente SAN, telaio in ABS, base in PP, lama inox.



NEW

Chicory cutter

Taglia puntarelle
Chicoree-Schneider
Coupe-chicorée
Cortador de achicoria

| art. | cm. | € |
|----------|-------|-------|
| 48288-05 | 10x10 | 11,96 |

No dishwasher safe. Birch plywood, aluminum rivets, stainless steel wire. – Non lavabile in lavastoviglie. Multistrato di betulla, ribattini in alluminio, filo inox.



SS

Mushroom cutter

Taglia funghi
Pilze-Teiler
Tranche-champignons
Cortador de hongos

| art. | Ø cm. | l. cm. | € |
|----------|-------|--------|-------|
| 42598-00 | 7,6 | 20,7 | 37,79 |



SS

Avocado peeler and slicer

Pela/taglia avocado
Avocadoschäler-/Teiler
Pèle et tranche avocat
Pelador y cortador de aguacete

| art. | l. cm. | € |
|----------|--------|-------|
| 48286-62 | 18,5 | 27,54 |



SS

Large vegetable slicer

Pelaverdure
Gemüseschäler
Eplucheur à légumes
Pelador de verduras

| art. | cm. | € |
|----------|-------|-------|
| 48286-64 | 22x10 | 31,26 |



SS

Potato peeler

Pelapatate
Sparschäler
Eplucheur
Pelador de patatas

| art. | cm. | € |
|----------|-----|------|
| 42589-00 | 5x4 | 2,21 |

For left or right handed. – Per mancini e destrorsi.



SS

Potato ricer with 3 discs
Schiacciapatate, 3 griglie
Kartoffelpresse, 3 Roste
Presse-purée, 3 grilles
Pasapurés, 3 discos

| art. | Ø cm. | cm. | € |
|----------|-------|----------|-------|
| 42566-03 | 8,5 | 30x10x11 | 27,64 |

Discs/Dischi: ø 2,4 - 4,4 - 6,5 mm.



SS

French fry cutter
Taglia patate
Kartoffelschneidergerät
Coupe-frites
Cortador de patatas fritas

| art. | cm. | Kg. | € |
|----------|----------|-----|--------|
| 49832-10 | 24x44x34 | 11 | 534,06 |

Cutting knife/Quadro di taglio: 10 mm.



SS

French fry cutter
Taglia patate
Kartoffelschneidergerät
Coupe-frites
Cortador de patatas fritas

| art. | cm. | € |
|----------|------------|--------|
| 49831-10 | 28x11x16,5 | 227,33 |

Functional and solid. With suction base. Space-saving size. Accurate cutting 10 mm. Easy to clean – Funzionale e solido. Base con ventose. Salvaspazio. Taglio preciso, 10 mm. Facile da pulire.



SS

French fry cutter
Taglia patate
Kartoffelschneidergerät
Coupe-frites
Cortador de patatas fritas

| art. | cm. | Kg. | € |
|----------|-----------|-----|-------|
| 49832-02 | 26x9x12,5 | 1,2 | 61,81 |

Cutting knives/Quadri di taglio: 9x9 - 12x12 mm.



Herb scissors, 5 blades
Forbice per erbe, 5 lame
Kräuterschere, 5 Klingen
Ciseaux à herbes, 5 lames
Tijeras hierbas, 5 cuchillas

| art. | l. cm. | € |
|----------|--------|------|
| 18277-00 | 10 | 8,04 |



SS

Tortillas wedger
Taglia tortillas
Tortillasteiler
Coupe-tortillas
Corta tortillas

| art. | Ø cm. | € |
|----------|-------|-------|
| 42599-06 | 25 | 47,13 |
| 42599-08 | 25 | - |

Wedges/Spicchi: 6 - 8.



SS

PS

Cheese rotary grater
Grattugia formaggio rotatoria
Drehe-Käse-Raffel
Frisette à fromage
Ralladora giratoria para queso

| art. | Ø cm. | h. | € |
|----------|-------|----|-------|
| 48281-22 | 22 | 17 | 59,30 |

Oak wood base. – Base legno di quercia.



SS

Cheese wire cutter
Lira per formaggi
Käse Drahtschneider
Lyre à fromage
Lira para quesos

| art. | cm. | € |
|----------|-----------|-------|
| 48282-21 | 20,5x26,7 | 25,02 |



Grater, automatic
 Grattugia automatica
 Reibe, automatisch
 Râpe automatique
 Rallador automático

art. cm. €
 48295-10 20x5,4 -

Hermetic container, removable, with lid, 2 blades. Ideal for cheese, nuts, chocolate, etc.
 Recipiente ermetico, removibile, con cop., 2 lame. Ideale per formaggio, noci, cioccolato, ecc.



Garlic press, chromed
 Spremiaglio, cromato
 Knoblauchpresse, verchromt
 Presse-ail, chromé
 Prensador de ajo, cromado

art. cm. l. cm. €
 42565-00 3,5x2,5 14,5 11,46



Olive seed remover, chromed
 Snocciolatore, cromato
 Olivenentsteiner, verchromt
 Dénoyateur, chromé
 Quita pepa/hueso, cromado

art. l. cm. €
 42563-00 17 7,94



Cherry core stripper
 Snocciolatore
 Kirschenentsteiner
 Dénoyateur de cerises
 Quita pepa/hueso

art. Ø cm. h. €
 42563-44 10 34 47,24



Mandoline
 Mandolino
 Gemüsehobel Mandoline
 Mandoline
 Mandolina

art. cm. Kg. €
 49829-11 39x12,5x5,5 1,7 109,24

Equipped with 7 interchangeable blades.
 Dotato di 7 lame intercambiabili.



Slicer Mandoline, Grand Gourmet
 Mandolino Grand Gourmet
 Gemüsehobel Grand Gourmet
 Mandoline Grand Gourmet
 Mandolina Grand Gourmet

art. cm. Kg. €
 49830-60 40x12x28 1,6 355,27

38 blades, 10 mm. – 38 lame, 10 mm.



SS

Mandoline

Mandolino
Gemüsehobel Mandoline
Mandoline
Mandolina

| art. | cm. | Kg. | € |
|----------|-------------|-----|--------|
| 49752-00 | 33,5x11x2,3 | 0,6 | 117,79 |

3 interchangeable blades of 2-3-6 mm.
3 lame intercambiabili da 2-3-6 mm.



ABS

Japanese Mandoline slicer

Mandolino giapponese
Japanese Gemüsehobel
Mandoline japonaise
Mandolina japonés

| art. | cm. | Kg. | € |
|----------|-----------|-----|--------|
| 49753-06 | 11x31,5x3 | 0,3 | 84,42 |
| 49753-09 | 15x35x3,3 | 0,5 | 153,16 |

1 plain blade and 3 blades of 1-2-3 mm.
1 lama liscia e 3 lame da 1-2-3 mm.



SS

Cutter/corer

Intaglia verdure
Ausstechforme
Découpoir
Sacabocados

| art. | cm. | € |
|----------|-----------|-------|
| 48286-70 | 3,7x8,5x9 | 23,01 |

Cutting ø 3,4 cm. – Taglio ø 3,4 cm.



ABS

SS

Spiral vegetable slicer 3-blade

Taglia verdure 3-lame
Gemüeschneider 3-Messer
Coupe légumes 3 lames
Cortador de verduras 3 cuchillas

| art. | cm. | € |
|----------|----------|-------|
| 49827-99 | 30x14x22 | 32,96 |

3 interchangeable s/s blades (3 - 6 mm. and 1 straight blade for ribbon cuts). – 3 lame inox intercambiabili (3 - 6 mm. e 1 lama dritta per taglio a nastro).



ABS

SS

Spiral vegetable slicer 7-blades 8-cuts

Taglia verdure 7-lame 8-tagli
Gemüeschneider 7-Messer 8-Schnitte
Coupe légumes 7-lames 8-coupees
Cortador de verduras 7-cuchillas 8-cortes

| art. | cm. | € |
|----------|----------------|-------|
| 49827-77 | 14,3x23,8x14,3 | 49,35 |

Includes: 4 mm straight blade, 10 mm chipper blade, 1,5 mm wavy blade, 2,5 mm straight blade, 2 mm Angel hair blade, 3 mm shredder blade, 6 mm chipper blade. Top-rack dishwasher-safe.
Include 2 lame lisce mm 2,5 e 4, lama ondulata da 1,5 mm, lama capelli d'angelo da 2 mm, 3 lame taglio spaghetti mm. 3, 6 e 10. Lavabile in lavastoviglie nel cestello superiore.



SS

Strip slicer

Taglia verdure
Gemüeschneider
Coupe-lanières
Cortador de verduras japonés

| art. | cm. | Kg. | € |
|----------|----------|-----|--------|
| 49823-00 | 20x20x25 | 1,9 | 813,35 |

Width of cut 15 cm. Max vegetables length 11 cm. and ø 17 cm. – Larghezza taglio 15 cm. Lunghezza max verdura 11 cm. e ø 17 cm.



ABS

Strip slicer

Taglia verdure
Gemüeschneider
Coupe lanière
Cortador de verduras

| art. | cm. | € |
|----------|------------|--------|
| 49823-89 | 28x25x16,5 | 961,28 |

Width of cut 13 cm. Thickness 0,5 mm.
Larghezza taglio 13 cm. Spessore 0,5 mm.



ABS

Strip & spaghetti slicer

Taglia verdure
Gemüeschneider
Coupe lanière et spaghetti
Cortador de verduras japonés

| art. | cm. | € |
|----------|------------|--------|
| 49823-99 | 28x25x16,5 | 961,28 |

Width of cut 13 cm. 2 blades 130x0,5 - 1x1,2 mm.
Larghezza taglio 13 cm. 2 lame 130x0,5 - 1x1,2 mm.



Vegetable cutter LE ROUET GOURMET

Taglia verdure
Gemüseschneider
Coupe légumes
Cortador de verduras

| art. | cm. | Kg. | € |
|----------|--------------|-----|--------|
| 49827-03 | 13,5x36x24,3 | 2,4 | 446,02 |

Cutting blocks 1-2-4 mm. Cutting thickness blade guirlandes 1>4 mm. – Pettini taglio 1-2-4 mm. Spessore taglio lama guirlandes 1>4 mm.

ABS
SS



Decoration tools 22 pcs

Attrezzi decoro, 22 pezzi
Dekoriersatz, 22-Tlg.
Outils de décor 22 pcs
Herramientas decoración 22 pz

| art. | cm. | € |
|----------|---------|-------|
| 48286-13 | 38,5x29 | 86,33 |

SS



Decoration tools 18 pcs

Attrezzi decoro, 18 pz
Dekoriersatz, 18-Tlg.
Outils de décor 18 pcs
Herramientas decoración 18 pz

| art. | € |
|----------|-------|
| 48286-03 | 48,14 |

SS



Thai knife

Stiletto thailandese
Thai-Messer
Stylet thaï
Cuchillo thaï

| art. | l. cm. | € |
|----------|--------|-------|
| 48286-08 | 16 | 67,84 |

SS



Ice knife

Coltello ghiaccio
Eis-Messer
Couteau à glace
Cuchillo para hielo

| art. | l. cm. | gr. | € |
|----------|---------|-----|-------|
| 47885-01 | 14+10,5 | 200 | 91,15 |



Chisel V shape

Scalpello ghiaccio a V
Eismeissel
Ciseau à glace
Cinsel a V para hielo

| art. | l. cm. | gr. | € |
|----------|--------|-----|--------|
| 47885-02 | 31,5 | 200 | 433,16 |



Chisel flat medium

Scalpello ghiaccio 3 lati smussati
Eismeissel
Ciseau à glace
Cinsel para hielo

| art. | l. cm. | gr. | € |
|----------|--------|-----|--------|
| 47885-03 | 50 | 600 | 227,93 |



Chisel flat big

Scalpello ghiaccio 1 lato smussato
Eismeissel
Ciseau à glace
Cinsel para hielo

| art. | l. cm. | gr. | € |
|----------|--------|-----|--------|
| 47885-04 | 74,5 | 820 | 250,75 |



Ice chisel set 4 pcs

Scalpelli ghiaccio 4 pz
Eismeissel 4 Stk
Ciseaux à glace 4 pcs
Cinseles para hielo 4 piezas

| art. | Kg. | € |
|----------|------|--------|
| 47885-05 | 1,93 | 953,14 |



Butter churn

Mantecatore per burro

Butterfaß

Baratte à beurre

Mantequera

| art. | cm. | lt. | € |
|----------|--------------|-----|--------|
| 48294-01 | 11,5x11,5x40 | 1,6 | 126,43 |



Butter mold

Stampo per burro

Butterform

Moule à beurre

Molde para mantequilla

| art. | cm. | gr. | € |
|----------|--------------|-----|-------|
| 48294-02 | 12,2x6,6x4,3 | 80 | 50,05 |
| 48294-03 | 15,8x9x5 | 125 | 59,19 |



Butter mold

Stampo per burro

Butterform

Moule à beurre

Molde para mantequilla

| art. | cm. | gr. | € |
|----------|------------|-----|-------|
| 48294-04 | 21x9,4x5,8 | 250 | 61,31 |



Grater, non-slip handle

Grattugia, manico antiscivolo

Reibe, Rutschfestes Griff

Râpe queue antidérapant

Rallador mango antiderrapante

| art. | cm. | l. cm. | € |
|----------|------|--------|-------|
| 42560-01 | 4x22 | 38,5 | 12,76 |



Grater, non-slip handle

Grattugia, manico antiscivolo

Reibe, Rutschfestes Griff

Râpe queue antidérapant

Rallador mango antiderrapante

| art. | cm. | l. cm. | € |
|----------|------|--------|-------|
| 42560-02 | 4x22 | 38,5 | 12,76 |



Grater, non-slip handle

Grattugia, manico antiscivolo

Reibe, Rutschfestes Griff

Râpe queue antidérapant

Rallador mango antiderrapante

| art. | cm. | l. cm. | € |
|----------|------|--------|-------|
| 42560-03 | 4x22 | 38,5 | 12,76 |



Grater, non-slip handle

Grattugia, manico antiscivolo

Reibe, Rutschfestes Griff

Râpe queue antidérapant

Rallador mango antiderrapante

| art. | cm. | l. cm. | € |
|----------|----------|--------|-------|
| 42560-04 | 7,7x13,3 | 30 | 13,27 |



Grater, non-slip handle

Grattugia, manico antiscivolo

Reibe, Rutschfestes Griff

Râpe queue antidérapant

Rallador mango antiderrapante

| art. | cm. | l. cm. | € |
|----------|----------|--------|-------|
| 42560-05 | 7,7x13,3 | 30 | 13,27 |



Grater, non-slip handle

Grattugia, manico antiscivolo

Reibe, Rutschfestes Griff

Râpe queue antidérapant

Rallador mango antiderrapante

| art. | cm. | l. cm. | € |
|----------|----------|--------|-------|
| 42560-06 | 7,7x13,3 | 30 | 13,27 |



Grater, non-slip handle
 Grattugia, manico antiscivolo
 Reibe, Rutschfestes Griff
 Râpe queue antidérapant
 Rallador mango antiderrapante

| art. | cm. | l. cm. | € |
|----------|----------|--------|-------|
| 42560-07 | 7,7x13,3 | 30 | 13,27 |



Grater, non-slip handle
 Grattugia, manico antiscivolo
 Reibe, Rutschfestes Griff
 Râpe queue antidérapant
 Rallador mango antiderrapante

| art. | cm. | l. cm. | € |
|----------|----------|--------|-------|
| 42560-08 | 7,7x13,3 | 30 | 13,27 |

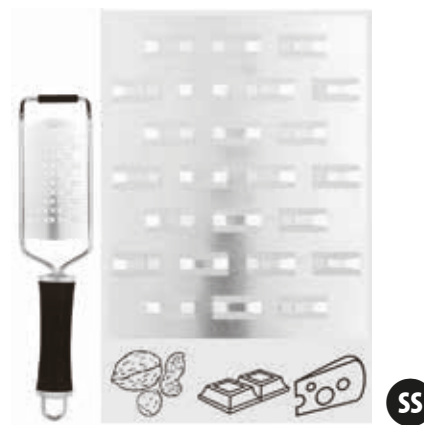

Grater, non-slip handle
 Grattugia, manico antiscivolo
 Reibe, Rutschfestes Griff
 Râpe queue antidérapant
 Rallador mango antiderrapante

| art. | cm. | l. cm. | € |
|----------|----------|--------|-------|
| 42560-09 | 7,7x13,3 | 30 | 13,27 |



Nutmeg grater
 Grattugia noce moscata
 Muskatreibe
 Râpe à muscade
 Rallador nuez moscada

| art. | cm. | € |
|----------|--------|------|
| 42556-00 | 4,5x14 | 3,02 |



Spatzle sieve
 Grattugia per spatzle
 Spätzle-Reibe
 Grille à spatzle
 Rallador para spatzle

| art. | cm. | € |
|----------|-----------|-------|
| 49844-01 | 31x10,5x6 | 31,66 |



4-ways grater
 Grattugia 4 tagli
 Vierkantreibe
 Râpe 4 faces
 Rallador 4 caras

| art. | cm. | € |
|----------|---------|-------|
| 42569-04 | 10x8x23 | 10,45 |



Dumplin maker
 Stampo panzerotti
 Knödel-Form
 Moule à chaussons
 Molde para empanadillas

| art. | mm. | € |
|----------|------------------|------|
| 49843-05 | 62, 82, 104, 177 | 9,95 |



Safety can opener
 Apriscatole sicuro
 Sicherheitsdosenöffner
 Ouvre-boîte de sûreté
 Abrelatas de seguridad

| art. | cm. | € |
|----------|--------|-------|
| 48222-01 | 12,5x8 | 35,18 |



Universal can opener

Apriscatole universale, nichelato
Universal-Dosenöffner
Ouvre-boîte, universel
Abrelatas universal

| art. | cm. | € |
|----------|-----|-------|
| 48220-00 | 8x7 | 13,07 |



Can opener, PP handle

Apriscatole, impugnatura PP
Dosenöffner, Griffe aus PP
Ouvre-boîte, poignées PP
Abrelatas, mango PP

| art. | l. cm. | € |
|----------|--------|-------|
| 48280-03 | 21 | 17,29 |



SS

Electric sieve

Passaverdura elettrico
Elektropassiergerät
Moulin électrique
Molino eléctrico

| art. | Ø cm. | h. | kg./H | Kg. | € |
|----------|-------|-----|-------|------|----------|
| 49879-37 | 37 | 108 | 300 | 23,5 | 3.879,60 |

Equipped with 3 mm disc. – Griglia 3 mm.



Sieve on tripod, tinned

Passaverdura stagnato con supporto
Passiergerät, verzinkt, mit Träger
Moulin étamé sur pied
Molino estañado sobre pie

| art. | Ø cm. | h. | Kg. | € |
|----------|-------|----|-----|--------|
| 42577-39 | 39 | 80 | 14 | 988,02 |

Equipped with 3 mm disc. – Griglia 3 mm.



Tomato juicer sieve

Passapomodoro professionale
Profi-Tomatenpassiergerät
Moulin à tomates professionnel
Molino para tomates, profesional

| art. | Ø cm. | h. | € |
|----------|-------|----|--------|
| 42576-00 | 21 | 50 | 133,87 |

Equipped with 1 mm disc. – Griglia 1 mm.



SS

Herb mill

Macinaerbe
Kräutermühle
Moulin fines herbes
Molino de hierbas finas

| art. | cm. | € |
|----------|------|-------|
| 42558-00 | 7x22 | 35,18 |



SS

Sieve, 3 discs

Passaverdura, 3 griglie
Passiergerät, 3 Roste
Moulin inox, 3 grilles
Molino inox, 3 rejillas

| art. | Ø cm. | h. | Kg. | € |
|----------|-------|------|------|-------|
| 42571-20 | 19 | 16,5 | 0,46 | 72,26 |
| 42572-24 | 24 | 16,5 | 0,82 | 84,12 |

Discs: 1,5 - 2 - 4 mm. – Griglie: 1,5 - 2 - 4 mm.



SS

Sieve, 3 discs

Passaverdura, 3 griglie
Passiergerät, 3 Roste
Moulin inox, 3 grilles
Molino inox, 3 rejillas

| art. | Ø cm. | h. | Kg. | € |
|----------|-------|----|-----|--------|
| 42570-32 | 31 | 25 | 1,4 | 174,77 |

Discs: 1,5 - 2,5 - 4 mm. – Griglie: 1,5 - 2,5 - 4 mm.



Sieve, tinned, 3 discs

Passaverdura stagnato, 3 griglie
Passiergerät, verzinkt, 3 Roste
Moulin étamé, 3 grilles
Molino estañado, 3 rejillas

| art. | Ø cm. | h. | Kg. | € |
|----------|-------|----|-----|--------|
| 42573-31 | 31 | 25 | 1,4 | 154,47 |

Discs: 1,5 - 2,5 - 4 mm. – Griglie: 1,5 - 2,5 - 4 mm.



SS

Sieve, 1 disc

Passaverdura, 1 griglia
Passiergerät, 1 Rost
Moulin inox, 1 grille
Molino inox, 1 rejilla

| art. | Ø cm. | h. | Kg. | € |
|----------|-------|----|-----|--------|
| 42574-37 | 37 | 32 | 3,5 | 506,82 |

Equipped with 3 mm disc. – Griglia 3 mm.



Sieve, tinned, 1 disc

Passaverdura stagnato, 1 griglia
Passiergerät, verzinkt, 1 Rost
Moulin étamé, 1 grille
Molino estañado, 1 rejilla

| art. | Ø cm. | h. | Kg. | € |
|----------|-------|----|-----|--------|
| 42575-37 | 37 | 32 | 3,5 | 422,90 |

Equipped with 3 mm disc. – Griglia 3 mm.



42570 - 42573



42574 - 42575

42577 - 49879



SS

Table top can opener

Apriscatole da banco
Tisch-Dosenöffner
Ouvre-boîte
Abrelatas

| art. | cm. | Kg. | € |
|----------|--------------|-----|----------|
| 49867-01 | 28x12,2x77,5 | 5 | 1.026,91 |

With screw base. Patented opening system. Opens round cans any sizes securely from 8 to 50 cm height), leaves smooth and not sharp edges. The cap can be reused. Dishwasher safe. Base da avvitare. Sistema di apertura brevettato. Per scatole rotonde di tutte le dimensioni (h da 8 a 50 cm). Rifilo netto dei bordi esterni. Nessun rischio di taglio. Possibilità di riutilizzare il coperchio dalla scatola. Lavabile in lavastoviglie.



SS

Table top can opener

Apriscatole da banco
Tisch-Dosenöffner
Ouvre-boîte
Abrelatas

| art. | cm. | Kg. | € |
|----------|--------------|-----|----------|
| 49867-02 | 28x12,2x77,5 | 5 | 1.086,00 |

With clamp base. Patented opening system. Opens round cans any sizes securely from 8 to 50 cm height), leaves smooth and not sharp edges. The cap can be reused. Dishwasher safe. Base con morsetto. Sistema di apertura brevettato. Per scatole rotonde di tutte le dimensioni (h da 8 a 50 cm). Rifilo netto dei bordi esterni. Nessun rischio di taglio. Possibilità di riutilizzare il coperchio dalla scatola. Lavabile in lavastoviglie.



Table top can opener

Apriscatole da banco
Tisch-Dosenöffner
Ouvre-boîte
Abrelatas

| art. | l. cm. | € |
|----------|--------|--------|
| 19810-00 | 56 | 144,52 |

Can size up to height 45 cm. Clamp base and bar in die-cast aluminum, steel head. Table fixing either with screws or clamp. – Altezza scatola fino a 45 cm. Corpo in alluminio pressofuso, testa in acciaio, fissaggio a viti o morsetto.



Table top can opener, steel

Apriscatole da banco, acciaio
Tisch-Dosenöffner, Stahl
Ouvre-boîte, acier
Abrelatas, acero

| art. | l. cm. | € |
|----------|--------|--------|
| 49811-00 | 40 | 224,42 |

Can size up to height 30 cm. Table fixing with clamp base. – Altezza scatola fino a 30 cm. Fissaggio a morsetto.



SS

Table top can opener

Apriscatole da banco
Tisch-Dosenöffner
Ouvre-boîte
Abrelatas

| art. | l. cm. | € |
|----------|--------|--------|
| 49812-00 | 55 | 738,98 |

Can size up to height 40 cm. Table fixing with clamp base. – Altezza scatola fino a 40 cm. Fissaggio a morsetto.



SS

Electric can opener

Apriscatole elettrico
Elektrodosenöffner
Ouvre-boîte électrique
Abrelatas eléctrico

| art. | cm. | Kg. | € |
|----------|----------|-----|----------|
| 49814-00 | 44x25x75 | 13 | 2.973,69 |

Dual speed motor. Opens all can shapes from 50 to 270 mm height. – Motore a 2 velocità. Per tutti i formati di scatola da 50 a 270 mm di altezza.

THERMOMETERS TERMOMETRI

KITCHEN UTENSILS
UTENSILI DA CUCINA





SS

Meat roasting thermometer

Termometro arrosti
Braten-Thermometer
Thermomètre à rôtir
Termómetro asado

| art. | Ø cm. | div | range | € |
|----------|-------|-----|---------|-------|
| 49705-00 | 4,5 | 1°C | 0+120°C | 15,78 |

Penetration probe 13 cm. – Sonda l. 13 cm.



SS

Meat roasting thermometer

Termometro arrosti
Braten-Thermometer
Thermomètre à rôtir
Termómetro asado

| art. | Ø cm. | range | € |
|----------|-------|----------|------|
| 19705-00 | 5 | +54+88°C | 7,74 |

Steam ø 6x107 mm. – Sonda ø 6x107 mm.



SS

Cooking & frying thermometer

Termometro fritti
Back-Thermometer
Thermomètre à friture
Termómetro frituras

| art. | Ø cm. | div | range | € |
|----------|-------|-----|-----------|------|
| 19706-00 | 5 | 5°C | +50+200°C | 9,45 |

Steam ø 5x311 mm. – Sonda ø 5x311 mm.

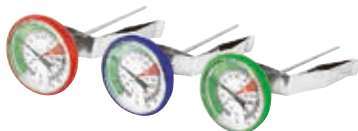

SS

Milk frothing thermometers, 3 pcs

Termometri latte/barista, 3 pz
Mich-Thermometer, 3 Stk
Thermomètres à lait, 3 pièces
Termómetros leche, 3 pz

| art. | Ø cm. | div | range | € |
|----------|-------|-----|-----------|-------|
| 49709-03 | 4,5 | 1°C | -10+110°C | 26,33 |

Red, green and blue, to easily identify different types of milk used, to avoid cross-contamination.

Stem 175 mm. – Rosso, verde e blu, per identificare facilmente i diversi tipi di latte utilizzati, per evitare la contaminazione incrociata. Stelo 175 mm.



Sugar thermometer

Termometro per zucchero
Zuckerthermometer
Thermomètre à sucre
Termómetro azúcar

| art. | l. cm. | div | range | € |
|----------|--------|-----|-----------|-------|
| 47843-00 | 30 | 1°C | +80+200°C | 40,70 |

Stainless steel housing. – Guaina inox.



Sugar/jam thermometer

Termometro per zucchero/marmellata
Zucker- und Marmeladenthermometer
Thermomètre à sucre et confiture
Termómetro azúcar y mermelada

| art. | div | range | € |
|----------|-----|-----------|-------|
| 47843-05 | 2°C | +40+200°C | 34,07 |

Brass. – Ottone. Dim. 4,7x20 cm.



Baker's thermometer

Termometro per panettiere
Bäckerthermometer
Thermomètre boulanger
Termómetro panadero

| art. | l. cm. | div | range | € |
|----------|--------|-----|----------|-------|
| 49712-00 | 30 | 1°C | -10+60°C | 16,18 |

Plastic housing. – Guaina plastica.



SS

Oven thermometer

Termometro per forno
Ofenthermometer
Thermomètre à four
Termómetro horno

| art. | Ø cm. | div | range | € |
|----------|-------|------|-----------|------|
| 19709-00 | 7 | 10°C | +50+300°C | 8,24 |



ABS

Fridge/freezer thermometer

Termometro frigo/freezer
Kühlschrank-Thermometer
Thermomètre à réfrigérateur
Termómetro congelador

| art. | Ø cm. | div | range | € |
|----------|-------|-----|----------|------|
| 49885-02 | 7 | 1°C | -50+50°C | 5,53 |



SS

Fridge/freezer thermometer

Termometro frigo/freezer
Kühlschrank-Thermometer
Thermomètre à réfrigérateur
Termómetro congelador

| art. | Ø cm. | div | range | € |
|----------|-------|-----|----------|------|
| 19702-00 | 6 | 1°C | -30+30°C | 6,33 |



ABS

Digital thermometer

Termometro digitale
Digitalthermometer
Thermomètre digitale
Termómetro digital

| art. | div | range | € |
|----------|-------|----------|-------|
| 49887-00 | 0,1°C | -50+70°C | 27,34 |

Dim. cm. 1,5x5x7



Digital fridge thermometer

Termometro digitale per frigorifero
Kühlschrank-Digitalthermometer
Thermomètre digitale à réfrigérateur
Termómetro digital para refrigerador

| art. | div | range | € |
|----------|-------|-------------|-------|
| 49887-02 | 0,1°C | -9,9+49,9°C | 18,29 |

Dim. Cm. 2,6x4,5x7,3. Water resistant IP65.
Features a food safety zone icon in the display that indicates when the temperature is outside the range of 0 to 5°C. – Resistente all'acqua IP65. Un'icona indica sul display quando la temperatura è al di fuori dell'intervallo da 0 a 5°C.



Room/wall thermometer

Termometro da muro
Wandthermometer
Thermomètre à mur
Termómetro de pared

| art. | div | range | € |
|----------|-----|----------|------|
| 49702-00 | 1°C | -30+50°C | 4,42 |

Dim. cm. 20,5x4. Without mercury.
Senza mercurio.



Pocket thermometer

Termometro da tasca
Taschenthermometer
Thermomètre à poche
Termómetro digital

| art. | div | range | € |
|----------|-------|-----------|-------|
| 19701-00 | 0,1°C | -40+150°C | 18,49 |

S/steel steam 130 mm. – Sonda inox 130 mm.



Digital thermometer

Termometro digitale
Digitalthermometer
Thermomètre digitale
Termómetro digital

| art. | div | range | € |
|----------|-----|-----------|-------|
| 49710-00 | 1°C | -50+300°C | 42,91 |

IP 65. Probe 135 mm. ø 2,5 mm.
Sonda 135 mm. ø 2,5 mm.



Pocket thermometer

Termometro da tasca
Taschenthermometer
Thermomètre à poche
Termómetro digital

| art. | div | range | € |
|----------|-------|-----------|-------|
| 49701-00 | 0,1°C | -50+200°C | 26,33 |

Probe 125 mm. ø 3,5 mm.
Sonda 125 mm. ø 3,5 mm.



Digital thermometer

Termometro digitale
Elektronisches Thermometer
Thermomètre digital
Termómetro digital

| art. | div | range | € |
|----------|-------|-----------|-------|
| 49715-00 | 0,1°C | -50+300°C | 33,17 |

Probe 125 mm. ø 3,5 mm.
Sonda 125 mm. ø 3,5 mm.



Digital thermometer

Termometro digitale
Elektronisches Thermometer
Thermomètre digital
Termómetro digital

| art. | div | range | € |
|----------|-------|-----------|-------|
| 49716-00 | 0,1°C | -50+300°C | 77,18 |

Dim. cm. 1,9x7x15,2. Countdown/up 99h-59m.



Digital thermometer

Termometro digitale
Elektronisches Thermometer
Thermomètre digital
Termómetro digital

| art. | div | range | € |
|----------|-------|-----------|--------|
| 49883-00 | 0,1°C | -50+300°C | 139,49 |

Dim. cm. 13x5,5x2,5. Probe 13 cm. ABS case incl. Biomaster AT. – Involucro ABS con Biomaster.
Sonda 13 cm.



Multi-function thermometer

Termometro multifunzione
Multifunktions-Thermometer
Thermomètre multifonction
Termómetro multifunción

| art. | div | range | € |
|----------|-------|---------------|-------|
| 49988-00 | 0,1°C | -19,9+149,9°C | 20,30 |

Dim. cm. 2,5x7,3x12,3. Probe 125 mm. ø 3,5.
Housing & probe handle incl. Biomaster AT.
Involucro e manico sonda con Biomaster. Sonda 125 mm. ø 3,5.



Infrared thermometer

Termometro a infrarossi
Infrarot-Thermometer
Thermomètre infrarouge
Termómetro infrarrojo

| art. | div | range | € |
|----------|-------|---------------|-------|
| 49986-00 | 0,1°C | -49,9+349,9°C | 48,74 |

Dim. cm. 2,5x5,2x10



Infrared thermometer

Termometro a infrarossi
Infrarot-Thermometer
Thermomètre infrarouge
Termómetro infrarrojo

| art. | div | € |
|----------|---------|--------|
| 49884-08 | 0,1/1°C | 139,49 |

Dim. cm. 4x6,6x15,5. Range infrared-Infrarossi: -60 to 500°C – Range probe-Sonda: -64 to 1370°C.



Infrared thermometer

Termometro a infrarossi
Infrarot-Thermometer
Thermomètre infrarouge
Termómetro infrarrojo

| art. | div | range | € |
|----------|-----|-----------|--------|
| 49717-00 | 1°C | -50+400°C | 142,11 |

Dim. cm. 17,5x4x7,2



Infrared thermometer

Termometro a infrarossi
Infrarot-Thermometer
Thermomètre infrarouge
Termómetro infrarrojo

| art. | div | range | € |
|----------|-------|-----------|-------|
| 49987-00 | 0,1°C | -50+330°C | 66,03 |

Dim. cm. 3,6x8,8x13,1



Waterproof thermometer

Termometro waterproof
Waterproof-Thermometer
Thermomètre waterproof
Termómetro waterproof

| art. | div | range | € |
|----------|-------|-----------|-------|
| 49711-00 | 0,1°C | -50+300°C | 40,60 |

Dim. Ø 51x178 mm. Waterproof IP66. Auto-rotating display. S/steel penetration probe Ø 2,5x70 mm stainless steel, Ø 1,6 mm tip.
Impermeabile IP66. Display a rotazione automatica. Sonda di penetrazione inox Ø 2,5x70 mm., punta Ø 1,6 mm.



Digital thermo whisk

Termometro digitale con frusta
Schneebeesen mit Thermometer
Thermo-fouet digital
Termo-batidor digital

| art. | l. cm. | range | € |
|----------|--------|-----------|-------|
| 49728-00 | 30 | -30+300°C | 70,65 |





Spatula with thermometer
Spatola con termometro
Rührspaten mit Thermometer
Spatule avec thermomètre
Espátula con termómetro

| art. | range | € |
|----------|-----------|-------|
| 49729-00 | -50+300°C | 28,64 |

Dim. cm. 26x4x1,8



Digital thermometer
Termometro digitale
Elektronisches Thermometer
Thermomètre digital
Termómetro digital

| art. | div | range | col. | € |
|----------|---------|---------------|------|--------|
| 49880-10 | 0,1/1°C | -49,9+299,9°C | ● | 111,76 |
| 49880-11 | 0,1/1°C | -49,9+299,9°C | ● | 111,76 |
| 49880-12 | 0,1/1°C | -49,9+299,9°C | ● | 111,76 |

Dim. cm. 1,9x5x15,7. IP67. S/steel probe Ø 3,3 x 110 mm. folds back through 180°.



Digital thermometer
Termometro digitale
Elektronisches Thermometer
Thermomètre digital
Termómetro digital

| art. | div | range | col. | € |
|----------|---------|---------------|------|--------|
| 49880-13 | 0,1/1°C | -49,9+299,9°C | ● | 111,76 |
| 49880-14 | 0,1/1°C | -49,9+299,9°C | ● | 111,76 |
| 49880-15 | 0,1/1°C | -49,9+299,9°C | ○ | 111,76 |
| 49880-17 | 0,1/1°C | -49,9+299,9°C | ● | 111,76 |

Sonda inox ø 3,3 x 110 mm. pieghevole a 180°.



Sous vide cooking thermometer
Termometro per sottovuoto
Vakuüm-Koch-Thermometer
Thermomètre pour cuisson sous-vide
Termómetro cocción al vacío

| art. | div | range | € |
|----------|-------|----------------------------------|--------|
| 49881-01 | 0,1°C | -99,9+299,9°C 1°C +300+1372°C | 214,57 |

Kit: thermometer, Sous-Vide needle probe 60 mm., one metre foam/tape, zip pouch, free traceable certificate of calibration.

Kit: termometro, sonda per sottovuoto 60 mm., 1 metro di nastro adesivo, astuccio con zip, certificato di calibrazione tracciabile.



Sous vide cooking thermometer
Termometro per sottovuoto
Vakuüm-Koch-Thermometer
Thermomètre pour cuisson sous-vide
Termómetro cocción al vacío

| art. | div | range | € |
|----------|-------|---------------|--------|
| 49881-11 | 0,1°C | -49,9+299,9°C | 142,21 |

Dim. 1,9x4,7x15,3 cm. S/steel needle probe Ø 1,1 x 60 mm. FREE traceable certificate of calibration incl. – Sonda ad ago inox Ø 1,1 x 60 mm. Certificato di calibrazione incl.



Sous vide foam tape
Nastro adesivo per sottovuoto
Vakuümschaumklebeband
Ruban adhésif pour sous-vide
Cinta adhesiva para cocción al vacío

| art. | l. cm. | € |
|----------|--------|-------|
| 49881-99 | 100 | 22,01 |

Used in conjunction with thermometer to measure the core temperature without suffering water ingress into vacuum sealed bag.

Utilizzato in combinazione con il termometro evita che penetri acqua nel sacchetto sotto vuoto.



Digital oven thermometer

Termometro digitale da forno
Ofen-Digitalthermometer
Thermomètre à four digital
Termómetro horno digital

| art. | Ø cm. | div | range | € |
|----------|-------|-------|-----------|-------|
| 49719-00 | 8 | 1°C/F | -50+300°C | 60,90 |

Loud 70dB audible temperature alarm. 114 mm probe with 1,2 metre s/s braided lead that allows the probe to remain in the food during cooking. Water/dust resistance: IP65 protection.

Allarme acustico 70dB. Sonda 114 mm., cavo inox 1,2 metri che permette l'utilizzo durante la cottura. Resistenza acqua/polvere. IP65.



Waterproof digital timer

Timer digitale a tenuta stagna
Wasserdichte Digitaltimer
Timer digital étanche
Reloj digital impermeable

| art. | Ø cm. | h. | € |
|----------|-------|----|-------|
| 49733-00 | 8 | 17 | 36,88 |

IP 65. 99M-99S. Dust and flour proof. Sound and flashing alarms. Hanging hook and suction cup. – A prova di polvere e farina. Suono e allarme lampeggiante. Gancio e ventosa.



Digital timer

Timer digitale
Digitalkochalarm
Minuterie digitale
Reloj digital

| art. | cm. | € |
|----------|-------|-------|
| 49720-00 | 7x5,5 | 25,23 |

Timer 23H-59M-59S. Clock 12H AM/PM. Count down. 80dB audible alarm. Magnetic pad.

Orologio 12H AM/PM. Cronometro. Allarme acustico 80dB. Attacco magnetico.



Digital timer

Timer digitale
Digitalkochalarm
Minuterie digitale
Reloj digital

| art. | cm. | € |
|----------|-----------|-------|
| 49734-00 | 9x4,7x4,5 | 40,70 |

Count-down/up: 23H 59M 59S. 80 dB sound. 1 AAA battery.



Digital timer jumbo

Timer digitale gigante
Digitalkochalarm jumbo
Minuterie digitale géante
Reloj digital gigante

| art. | cm. | € |
|----------|-------------|--------|
| 49735-00 | 13,5x9,5x16 | 149,34 |

80dB sound. 4 programs. Electrical plug & battery. Waterproof front panel IP54.

Pres a elettrica e batteria. Pannello frontale impermeabile IP54.



Thermohygrometer with clock

Termoigrometro con orologio
Thermohygrometer mit Uhr
Thermohygromètre avec horloge
Termohigrómetro con reloj

| art. | cm. | range | € |
|----------|-----------|----------|-------|
| 49721-03 | 13x10x2,5 | -20+50°C | 61,61 |

10-99% RH - 12/24 H.



Syrup hydrometer

Densimetro per sciroppo
Sirup-Hydrometer
Hydromètre à sirop
Hidrómetro de jarabe

| art. | l. cm. | € |
|----------|--------|-------|
| 49703-00 | 12,5 | 17,19 |

1100-1400 g/m - 15-40°Bé



Hydrometer for brine and salt

Densimetro per salamoia e sale
Hydrometer für Sole und Salz
Hydromètre à saumure et sel
Hidrómetro de salmuera y sal

| art. | l. cm. | € |
|----------|--------|-------|
| 49730-20 | 19,5 | 17,89 |

1000-1250 g/m - 0-30°Bé



Salt tester and thermometer

Salinometro e termometro
Salzgehalt-Meter u. Thermometer
Testeur de salinité et thermometer
Salinómetro y termómetro

| art. | cm. | € |
|----------|--------------|--------|
| 49730-00 | 3,2x1,6x22,5 | 171,45 |

To measure the salt content of food and liquids in percentage from 0 to 5%. Temperature from 0°+100°C. – Per misurare il tenore di sale in alimenti e liquidi in percentuale da 0 a 5%. Temperatura da 0°+100° C.



Frying oil test strips

Strisce reattive per oli di frittura
Bratöl-Teststreifen
Bandes réactives pour les huiles de friture
Tiras reactivas para control aceites

| | |
|----------|-------|
| art. | € |
| 49731-99 | 71,05 |

Storage bottles of 100 Oil Quality Test Strips and easy to read colour chart. Hold the test strip in the oil for 2 seconds (max 40°C), then remove it and wait 2 minutes, next, compare the strip to the colour chart. – Flacone con 100 strisce reattive e tabella colori di facile lettura. Immergere la fascia colorata della striscia nell'olio (max. 40°C) per 2 secondi, quindi rimuoverla e attendere 2 minuti. Confrontare la striscia con la tabella colori.



Frying oil tester

Test degradazione oli di frittura
Kontrollsystem für Bratenöl
Test dégradation des huiles de friture
Test para control aceites

| | |
|----------|--------|
| art. | € |
| 49731-10 | 241,60 |

Consisting of two reagents that are not harmful to health and environmentally friendly. For 20 tests. ATTENTION: works with all types and brands of frying oil, (except with palm oil). – Composto da due reagenti non nocivi per la salute e rispettosi dell'ambiente. Per 20 test. ATTENZIONE: funziona con tutti i tipi e le marche di olio di frittura, (tranne che con l'olio di palma).



- 😊 **NEW OIL** <9% of polar compounds
OLIO NUOVO <9% di composti polari
- 😐 **GOOD OIL** from 10 to 16% of polar compounds
OLIO BUONO da 10 a 16% di composti polari
- 😞 **DETERIORATED OIL** from 17 to 23% of polar compounds
OLIO DETERIORATO da 17 a 23% di composti polari
- 😡 **OIL TO CHANGE** >24% of polar compounds
OLIO DA CAMBIARE >24% di composti polari



Labels solvable

Etichette dissolvibili
Lösbare Etiketten
Etiquettes solubles
Etiquetas solubles

| | | | |
|----------|-------|--------|-------|
| art. | cm. | pcs/pz | € |
| 44630-01 | 7,5x4 | 250 | 33,97 |

Dissolvable in less than 20 seconds. Suitable for any type of surface. – Dissolvibili in meno di 20 secondi. Adatte a qualsiasi tipo di superficie.



Labels 14 allergens

Etichette 14 allergeni
Etiketten 14 Allergene
Etiquettes 14 allergènes
Etiquetas 14 allergenos

| | | | |
|----------|-------|--------|-------|
| art. | cm. | pcs/pz | € |
| 44630-02 | 7,5x4 | 500 | 20,20 |

Labels with all 14 allergens pre-printed.
Etichette con i 14 allergeni prestampati.



Labels Express 7 days

Etichette express 7 giorni
Etiketten Express 7 Tage
Etiquettes express 7 jours
Etiquetas express 7 días

| | | | |
|----------|-------|--------|-------|
| art. | cm. | pcs/pz | € |
| 44630-03 | 3x2,5 | 1750 | 75,38 |

Different colors based on the day of the week. Data to be written: product description; date of production or expiry date. – Diversi colori in base al giorno della settimana. Dati da inserire: descrizione del prodotto; data di produzione o data di scadenza.

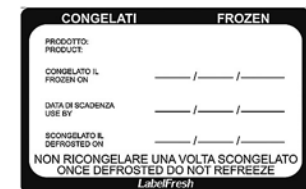

Labels frozen food

Etichette frozen/surgelati
Etiketten Tiefkühlkost
Etiquettes aliments surgelés
Etiquetas alimentos congelados

| | | | |
|----------|-------|--------|-------|
| art. | cm. | pcs/pz | € |
| 44630-04 | 7x4,5 | 500 | 20,30 |

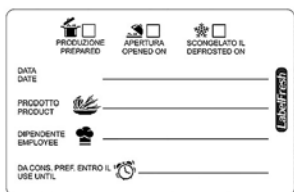

Labels TMC
Etichette TMC
Etiketten TMC
Etiquettes TMC
Etiquetas TMC

| art. | cm. | pcs/pz | € |
|----------|-------|--------|-------|
| 44630-05 | 7x4,5 | 300 | 19,40 |

TMC: Termine minimo di conservazione.

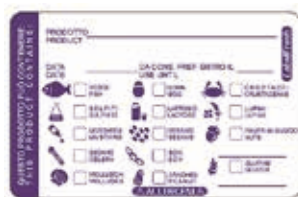

Labels Allergens
Etichette allergeni
Etiketten Allergene
Etiquettes allergènes
Etiquetas alérgenos

| art. | cm. | pcs/pz | € |
|----------|-------|--------|-------|
| 44630-06 | 7x4,5 | 500 | 20,30 |



Labels delivery with allergens
Etichette delivery con allergeni
Etiketten Lieferung mit Allergenen
Etiquettes livraison avec allergènes
Etiquetas entrega con alérgenos

| art. | cm. | pcs/pz | € |
|----------|--------|--------|-------|
| 44630-07 | 14x4,5 | 250 | 28,94 |



Wall clock
Orologio da parete
Wanduhr
Horloge à paroi
Reloj de pared

| art. | Ø cm. | € |
|----------|-------|-------|
| 41380-01 | 26 | 42,91 |

Satin alloy. With hygrometer and thermometer.
Metallo satinato. Con igrometro e termometro.



Wall clock
Orologio da parete
Wanduhr
Horloge à paroi
Reloj de pared

| art. | Ø cm. | € |
|----------|-------|-------|
| 41380-02 | 30,5 | 38,59 |

Silent clock. – Movimento silenzioso.



Digital spoon scale
Bilancia digitale a cucchiaino
Digitale Löffelwaage
Balance-cuillère numérique
Cuchara pesa numérica

| art. | mm. | cap | € |
|----------|-----------|------|-------|
| 49727-00 | 225x49x25 | 500g | 48,74 |



Mechanical scale
Bilancia meccanica
Waage
Balance
Balanza

| art. | Ø cm. | Kg. | div | € |
|----------|-------|-----|-----|-------|
| 49864-03 | 20 | 3 | 10g | 77,49 |
| 49864-05 | 20 | 5 | 20g | 77,49 |



Mechanical scale
Bilancia meccanica
Waage
Balance
Balanza

| art. | Ø cm. | Kg. | div | € |
|----------|-------|-----|------|--------|
| 49864-20 | 25 | 20 | 100g | 141,71 |



Digital kitchen scale
Bilancia digitale da cucina
Digital-Küchenwaage
Balance de cuisine
Balanza digital de cocina

| art. | cm. | Kg. | div | € |
|----------|---------|-----|-----|-------|
| 49773-05 | 21,5x13 | 5 | 1g | 48,74 |



SS

ABS

Digital kitchen scale

Bilancia digitale da cucina
Digital-Küchenwaage
Balance de cuisine
Balanza digital de cocina

| art. | cm. | Kg. | div | € |
|----------|-------------|-----|-----|-------|
| 49774-05 | 22,5x16,5x2 | 5 | 1g | 44,62 |



Pocket scale

Bilancia tascabile
Taschenwaage
Balance de poche
Balanza de bolsillo

| art. | cm. | Kg. | div | € |
|----------|-----------|------|-------|-------|
| 49771-00 | 15x10x2,5 | 0,25 | 0,1 g | 49,45 |



SS

ABS

Pocket scale

Bilancia tascabile
Taschenwaage
Balance de poche
Balanza de bolsillo

| art. | cm. | Kg. | div | € |
|----------|------------|-----|-------|-------|
| 49772-01 | 12,7x7,6x2 | 1 | 0,1 g | 29,75 |



SS

ABS

Electronic scale IP53

Bilancia elettronica
Elektronische Waage
Balance électronique
Balanza electrónica

| art. | cm. | Kg. | div | € |
|----------|------------|-----|-----|--------|
| 49863-15 | 31x30x11,5 | 12 | 1g | 286,93 |
| 49863-30 | 31x30x11,5 | 30 | 2g | 293,06 |
| 49863-50 | 31x30x11,5 | 50 | 5g | 312,96 |



ABS

Adapter for electronic scale

Adattatore per bilancia elettronica
Adapter für elektronische Waage
Adaptateur pour balance électronique
Adaptador para balanza electrónica

| art. | cm. | € |
|----------|----------|-------|
| 49863-AA | 16,5x4x7 | 19,40 |

Cable 1,5 mt. Not provided with scales. – Cavo 1,5 mt. Non fornito con le bilance.



ABS

SS

Digital scale IP44

Bilancia digitale
Digitalwaage
Balance digitale
Balanza digital

| art. | cm. | Kg. | div | € |
|----------|-------------|-----|-----|--------|
| 49775-05 | 24,5x31x9,5 | 5 | 1g | 251,45 |
| 49775-10 | 24,5x31x9,5 | 10 | 1g | 251,45 |



ABS

SS

Digital scale IP44

Bilancia digitale
Digitalwaage
Balance digitale
Balanza digital

| art. | cm. | Kg. | div | € |
|----------|------------|-----|-----|--------|
| 49777-50 | 29x33,5x11 | 50 | 1g | 300,90 |

Unit: Kg/lb.



SS

Digital scale IP67

Bilancia digitale
Digitalwaage
Balance digitale
Balanza digital

| art. | cm. | Kg. | div | € |
|----------|----------|-----|-----|--------|
| 49776-15 | 24x29x11 | 15 | 1g | 443,41 |
| 49776-30 | 24x29x11 | 30 | 2g | 443,41 |



ABS

SS

Digital scale with platform IP54

Bilancia digitale con piattaforma
Digitalwaage mit Plattform
Balance digitale avec plate-forme
Balanza digital con plataforma

| art. | cm. | Kg. | div | € |
|----------|----------|-----|-----|--------|
| 49779-15 | 50x40x84 | 150 | 20g | 458,18 |
| 49779-30 | 60x50x84 | 300 | 50g | 643,40 |

SERIES 18100

FORGED KNIVES
COLTELLI FORGIATI



A deep study and computerised tests of ergonomics, movement and posture have allowed Paderno to create a professional knives line, that is the synthesis of comfort and cutting precision. Handle made of plastic specially developed for the food processing sector, ergonomic design with soft edges, perfect grip to ensure precise guidance. The forged blade realised in special steel and molybdenum/vanadium, thanks to a peculiar hardening process, guarantees to the product a perfect cut and a long life of the blade's edge.

Uno studio approfondito e prove computerizzate di ergonomia, movimento e postura hanno permesso a Paderno di creare una linea di coltelli professionali, sintesi perfetta tra comfort e perfezione del taglio. Manico realizzato in speciale materiale plastico sviluppato per il settore alimentare, design ergonomico con bordi arrotondati, presa perfetta per garantire un taglio di precisione. Lama forgiata realizzata in lega di speciale acciaio, molibdeno e vanadio con particolare processo di tempra che garantisce al prodotto un ottimo taglio ed una perfetta e lunga tenuta di filo.



Cook's knife

Coltello cucina
Kochmesser
Couteau cuisine
Cuchillo de cocinero

| art. | cm. | € |
|----------|-----|-------|
| 18100-16 | 16 | 33,87 |
| 18100-20 | 20 | 39,80 |
| 18100-24 | 24 | 53,16 |
| 18100-30 | 30 | 68,04 |
| 18100-36 | 36 | 78,99 |



Butcher's knife

Coltello francese
Blockmesser
Couteau de chef
Cuchillo de carnicero

| art. | cm. | € |
|----------|-----|-------|
| 18102-16 | 16 | 38,09 |
| 18102-20 | 20 | 41,91 |
| 18102-26 | 26 | 47,13 |
| 18102-30 | 30 | 53,16 |



Oriental knife

Coltello orientale
Japanisches Kochmesser
Couteau de chef japonais
Cuchillo santoku

| art. | cm. | € |
|----------|-----|-------|
| 18103-18 | 18 | 55,28 |



Oriental knife, scalloped edge

Coltello orientale, alveolato
Japanisches Kochmesser mit Kullenschliff
Couteau de chef japonais alveolé
Cuchillo santoku alveolado

| art. | cm. | € |
|----------|-----|-------|
| 18104-18 | 18 | 59,60 |



Slicing knife

Coltello affettare
Fleischmesser
Tranchelard
Cuchillo trinchante

| art. | cm. | € |
|----------|-----|-------|
| 18106-15 | 15 | 30,05 |
| 18106-20 | 20 | 32,86 |
| 18106-25 | 25 | 39,70 |
| 18106-30 | 30 | 46,83 |



Ham knife

Coltello prosciutto
Schinkenmesser
Trancheur à jambon
Cuchillo para jamón

| art. | cm. | € |
|----------|-----|-------|
| 18109-26 | 26 | 44,12 |
| 18109-30 | 30 | 46,83 |



Ham knife, scalloped edge

Coltello prosciutto, alveolato
Schinkenmesser mit Kullenschliff
Couteau à jambon alvéolé
Cuchillo para jamón alveolado

| art. | cm. | € |
|----------|-----|-------|
| 18110-26 | 26 | 47,64 |
| 18110-30 | 30 | 50,75 |
| 18110-36 | 36 | 54,27 |



Salmon knife

Coltello salmone
Lachsmesser
Couteau à saumon
Cuchillo para salmón

| art. | cm. | € |
|----------|-----|-------|
| 18111-30 | 30 | 46,63 |



Salmon knife, scalloped edge

Coltello salmone, alveolato
Lachsmesser mit Kullenschliff
Couteau à saumon alvéolé
Cuchillo para salmón alveolado

| art. | cm. | € |
|----------|-----|-------|
| 18112-30 | 30 | 53,57 |



Carving knife

Coltello trinciante
Tranchiermesser
Couteau à découper
Cuchillo trinchante

| art. | cm. | € |
|----------|-----|-------|
| 18114-20 | 20 | 33,37 |



Fileting knife, flexible

Coltello filettare, flessibile
Filiermesser, flexibel
Couteau filet de sole, flexible
Cuchillo para filetear, flexible

| art. | cm. | € |
|----------|-----|-------|
| 18115-20 | 20 | 31,36 |
| 18115-25 | 25 | 39,09 |



Boning knife

Coltello disosso
Ausbeinmesser
Couteau à désosser
Cuchillo deshuesador

| art. | cm. | € |
|----------|-----|-------|
| 18116-14 | 14 | 30,95 |
| 18116-18 | 18 | 36,18 |



Steak knife serrated

Coltello bistecca seghettato
Steakmesser Wellenschliff
Couteau à steak dentelé
Cuchillo steak filo ondulado

| art. | cm. | € |
|----------|-----|-------|
| 18122-12 | 12 | 16,18 |



Paring knife

Spelucchino
Spickmesser
Couteau d'office
Cuchillo mondador

| art. | cm. | € |
|----------|-----|-------|
| 18124-09 | 9 | 20,10 |



Paring knife

Spelucchino
Spickmesser
Couteau d'office
Cuchillo mondador

| art. | cm. | € |
|----------|-----|-------|
| 18125-07 | 7 | 18,79 |
| 18125-10 | 10 | 19,80 |



Bent paring knife

Coltello cuoco
Tourniermesser
Couteau bec d'oiseau
Cuchillo para pelar

| art. | cm. | € |
|----------|-----|-------|
| 18126-07 | 7 | 19,30 |



Table knife serrated

Coltello tavola seghettato
Tafelmesser Wellenschliff
Couteau bout rond cranté
Cuchillo mesa filo ondulado

| art. | cm. | € |
|----------|-----|-------|
| 18123-11 | 11 | 18,69 |



Bread knife

Coltello pane
Brotmesser
Couteau à pain
Cuchillo para pan

| art. | cm. | € |
|----------|-----|-------|
| 18128-20 | 20 | 36,68 |
| 18128-24 | 24 | 38,59 |
| 18128-30 | 30 | 52,36 |



Meat fork

Forchettone
Fleischgabel
Fourchette baïonnette
Tenedor trinchante

| art. | cm. | € |
|----------|-----|-------|
| 18230-13 | 13 | 43,42 |
| 18230-17 | 17 | 43,01 |



Carving fork

Forchettone curvo
Fleischgabel
Fourchette courbe
Tenedor trinchante

| art. | cm. | € |
|----------|-----|-------|
| 18231-13 | 13 | 44,22 |



SERIES 18000

STAMPED KNIVES
COLTELLI TRANCIATI



The professional cutlery line "Color-Line" helps to reduce the risk of cross contamination using a Color Coding System which identifies each knife with a specific task: different food processing areas are easily identified. The steel used for this cutlery line has exceptional hardness and very high resistance to corrosion due to ICE-HARDENED system, a special process to harden the steel.

La linea di coltelleria professionale "CCS"– Color Coding System riduce i rischi di contaminazione incrociata grazie all'utilizzo di un Sistema di Codifica dei Colori che identifica ogni coltello per un uso specifico e permette di individuare facilmente le diverse aree di lavoro. Gli acciai utilizzati per questa linea di coltelleria presentano un'eccezionale durezza ed elevata resistenza alla corrosione, grazie all'uso del sistema ICE-HARDENING, processo speciale per temprare l'acciaio.



Cook's knife

Coltello cucina
Kochmesser
Couteau de cuisine
Cuchillo de cocinero

| art. | cm. | col. | € |
|----------|-----|------|-------|
| 18000-16 | 16 | ● | 14,17 |
| 18000-20 | 20 | ● | 16,68 |
| 18000-23 | 23 | ● | 21,91 |
| 18000-26 | 26 | ● | 26,53 |
| 18000-30 | 30 | ● | 30,25 |
| 18000-36 | 36 | ● | 39,09 |



Cook's knife

Coltello cucina
Kochmesser
Couteau de cuisine
Cuchillo de cocinero

| art. | cm. | col. | € |
|----------|-----|------|-------|
| 18000B16 | 16 | ● | 14,17 |
| 18000B20 | 20 | ● | 16,68 |
| 18000B23 | 23 | ● | 21,91 |
| 18000B26 | 26 | ● | 26,53 |
| 18000B30 | 30 | ● | 30,25 |



Cook's knife

Coltello cucina
Kochmesser
Couteau de cuisine
Cuchillo de cocinero

| art. | cm. | col. | € |
|----------|-----|------|-------|
| 18000G16 | 16 | ● | 14,17 |
| 18000G20 | 20 | ● | 16,68 |
| 18000G23 | 23 | ● | 21,91 |
| 18000G26 | 26 | ● | 26,53 |
| 18000G30 | 30 | ● | 30,25 |



Cook's knife

Coltello cucina
Kochmesser
Couteau de cuisine
Cuchillo de cocinero

| art. | cm. | col. | € |
|----------|-----|------|-------|
| 18000M16 | 16 | ● | 14,17 |
| 18000M20 | 20 | ● | 16,68 |
| 18000M23 | 23 | ● | 21,91 |
| 18000M26 | 26 | ● | 26,53 |



Cook's knife

Coltello cucina
Kochmesser
Couteau de cuisine
Cuchillo de cocinero

| art. | cm. | col. | € |
|----------|-----|------|-------|
| 18000R16 | 16 | ● | 14,17 |
| 18000R20 | 20 | ● | 16,68 |
| 18000R23 | 23 | ● | 21,91 |
| 18000R26 | 26 | ● | 26,53 |
| 18000R30 | 30 | ● | 30,25 |



Cook's knife

Coltello cucina
Kochmesser
Couteau de cuisine
Cuchillo de cocinero

| art. | cm. | col. | € |
|----------|-----|------|-------|
| 18000W20 | 20 | ○ | 16,68 |
| 18000W26 | 26 | ○ | 26,53 |
| 18000W30 | 30 | ○ | 30,25 |



Cook's knife

Coltello cucina
Kochmesser
Couteau de cuisine
Cuchillo de cocinero

| art. | cm. | col. | € |
|----------|-----|------|-------|
| 18000Y16 | 16 | ● | 14,17 |
| 18000Y20 | 20 | ● | 16,68 |
| 18000Y23 | 23 | ● | 21,91 |
| 18000Y26 | 26 | ● | 26,53 |



Slaughter/Butcher's knife

Coltello scimitarra
Schlacht U Fleischermesser
Couteau à découper
Cuchillo carnicero curvo

| art. | cm. | col. | € |
|----------|-----|------|-------|
| 18005-22 | 22 | ● | 23,42 |
| 18005-27 | 27 | ● | 26,23 |
| 18005-32 | 32 | ● | 30,75 |



Slaughter/Butcher's knife
Coltello scimitarra
Schlacht U Fleischermesser
Couteau à découper
Cuchillo carnicero curvo

| art. | cm. | col. | € |
|----------|-----|------|-------|
| 18005B22 | 22 | ● | 23,42 |
| 18005B27 | 27 | ● | 26,23 |
| 18005B32 | 32 | ● | 30,75 |



Slaughter/Butcher's knife
Coltello scimitarra
Schlacht U Fleischermesser
Couteau à découper
Cuchillo carnicero curvo

| art. | cm. | col. | € |
|----------|-----|------|-------|
| 18005G22 | 22 | ● | 23,42 |
| 18005G27 | 27 | ● | 26,23 |
| 18005G32 | 32 | ● | 30,75 |



Slaughter/Butcher's knife
Coltello scimitarra
Schlacht U Fleischermesser
Couteau à découper
Cuchillo carnicero curvo

| art. | cm. | col. | € |
|----------|-----|------|-------|
| 18005R22 | 22 | ● | 23,42 |
| 18005R27 | 27 | ● | 26,23 |
| 18005R32 | 32 | ● | 30,75 |



Slaughter/Butcher's knife
Coltello scimitarra
Schlacht U Fleischermesser
Couteau à découper
Cuchillo carnicero curvo

| art. | cm. | col. | € |
|----------|-----|------|-------|
| 18005Y22 | 22 | ● | 23,42 |
| 18005Y27 | 27 | ● | 26,23 |
| 18005Y32 | 32 | ● | 30,75 |



Butcher's knife
Coltello francese
Blockmesser
Couteau à découper
Cuchillo carnicero

| art. | cm. | col. | € |
|----------|-----|------|-------|
| 18002-18 | 18 | ● | 17,59 |
| 18002-20 | 20 | ● | 20,30 |
| 18002-22 | 22 | ● | 21,71 |
| 18002-26 | 26 | ● | 25,63 |
| 18002-30 | 30 | ● | 29,15 |
| 18002-36 | 36 | ● | 33,37 |



Butcher's knife
Coltello francese
Blockmesser
Couteau à découper
Cuchillo carnicero

| art. | cm. | col. | € |
|----------|-----|------|-------|
| 18002B26 | 26 | ● | 25,63 |



Butcher's knife
Coltello francese
Blockmesser
Couteau à découper
Cuchillo carnicero

| art. | cm. | col. | € |
|----------|-----|------|-------|
| 18002R18 | 18 | ● | 17,59 |
| 18002R20 | 20 | ● | 20,30 |
| 18002R22 | 22 | ● | 21,71 |
| 18002R26 | 26 | ● | 25,63 |
| 18002R30 | 30 | ● | - |
| 18002R36 | 36 | ● | 33,37 |



Butcher's knife
Coltello francese
Blockmesser
Couteau à découper
Cuchillo carnicero

| art. | cm. | col. | € |
|----------|-----|------|-------|
| 18002Y18 | 18 | ● | 17,59 |
| 18002Y26 | 26 | ● | 25,63 |
| 18002Y30 | 30 | ● | 29,15 |
| 18002Y36 | 36 | ● | 33,37 |



Slicing knife

Coltello affettare
Wurstmesser
Couteau à trancher
Cuchillo trinchante

| art. | cm. | col. | € |
|----------|-----|------|-------|
| 18006-20 | 20 | ● | 14,87 |
| 18006-25 | 25 | ● | 15,38 |
| 18006-30 | 30 | ● | 22,91 |
| 18006-36 | 36 | ● | - |



Slicing knife

Coltello affettare
Wurstmesser
Couteau à trancher
Cuchillo trinchante

| art. | cm. | col. | € |
|----------|-----|------|-------|
| 18006B20 | 20 | ● | - |
| 18006B25 | 25 | ● | 15,38 |
| 18006B30 | 30 | ● | 22,91 |



Slicing knife

Coltello affettare
Wurstmesser
Couteau à trancher
Cuchillo trinchante

| art. | cm. | col. | € |
|----------|-----|------|-------|
| 18006G20 | 20 | ● | 14,87 |
| 18006G25 | 25 | ● | 15,38 |



Slicing knife

Coltello affettare
Wurstmesser
Couteau à trancher
Cuchillo trinchante

| art. | cm. | col. | € |
|----------|-----|------|-------|
| 18006R25 | 25 | ● | 15,38 |
| 18006R30 | 30 | ● | 22,91 |



Slicing knife

Coltello affettare
Wurstmesser
Couteau à trancher
Cuchillo trinchante

| art. | cm. | col. | € |
|----------|-----|------|-------|
| 18006Y20 | 20 | ● | 14,87 |
| 18006Y25 | 25 | ● | 15,38 |
| 18006Y30 | 30 | ● | 22,91 |



Slicing knife, wavy blade

Coltello affettare, dentato
Wurstmesser mit Wellenschliff
Couteau à trancher dentelé
Cuchillo trinchante ondulado

| art. | cm. | col. | € |
|----------|-----|------|-------|
| 18007-25 | 25 | ● | 21,51 |
| 18007-30 | 30 | ● | 24,82 |
| 18007-36 | 36 | ● | 37,69 |



Slicing knife, wavy blade

Coltello affettare, dentato
Wurstmesser mit Wellenschliff
Couteau à trancher dentelé
Cuchillo trinchante ondulado

| art. | cm. | col. | € |
|----------|-----|------|-------|
| 18007G30 | 30 | ● | 24,82 |



Cook's knife

Coltello cucina
Kochmesser
Couteau de cuisine
Cuchillo de cocinero

| art. | cm. | col. | € |
|----------|-----|------|-------|
| 18008-20 | 20 | ● | 25,13 |
| 18008-26 | 26 | ● | 31,56 |
| 18008-30 | 30 | ● | 35,98 |
| 18008-36 | 36 | ● | 42,81 |



Cook's knife

Coltello cucina
Kochmesser
Couteau de cuisine
Cuchillo de cocinero

| art. | cm. | col. | € |
|----------|-----|------|-------|
| 18008B30 | 30 | ● | 35,98 |



Cook's knife

Coltello cucina
Kochmesser
Couteau de cuisine
Cuchillo de cocinero

| art. | cm. | col. | € |
|----------|-----|------|-------|
| 18008R26 | 26 | ● | 31,56 |
| 18008R30 | 30 | ● | 35,98 |
| 18008R36 | 36 | ● | 42,81 |



Cook's knife

Coltello cucina
Kochmesser
Couteau de cuisine
Cuchillo de cocinero

| art. | cm. | col. | € |
|----------|-----|------|-------|
| 18008Y30 | 30 | ● | 35,98 |



Ham knife

Coltello prosciutto
Schinkenmesser
Trancheur à jambon
Cuchillo para jamón

| art. | cm. | col. | € |
|----------|-----|------|-------|
| 18009-25 | 25 | ● | 18,59 |
| 18009-30 | 30 | ● | 21,31 |
| 18009-36 | 36 | ● | 24,42 |



Ham knife

Coltello prosciutto
Schinkenmesser
Trancheur à jambon
Cuchillo para jamón

| art. | cm. | col. | € |
|----------|-----|------|-------|
| 18009B25 | 25 | ● | 18,59 |



Ham knife

Coltello prosciutto
Schinkenmesser
Trancheur à jambon
Cuchillo para jamón

| art. | cm. | col. | € |
|----------|-----|------|---|
| 18009R25 | 25 | ● | - |



Ham knife

Coltello prosciutto
Schinkenmesser
Trancheur à jambon
Cuchillo para jamón

| art. | cm. | col. | € |
|----------|-----|------|-------|
| 18009W25 | 25 | ○ | 18,59 |
| 18009W30 | 30 | ○ | 21,31 |



Ham knife

Coltello prosciutto
Schinkenmesser
Trancheur à jambon
Cuchillo para jamón

| art. | cm. | col. | € |
|----------|-----|------|-------|
| 18009Y25 | 25 | ● | - |
| 18009Y30 | 30 | ● | 21,31 |



Salmon knife

Coltello salmone
Lachsmesser
Couteau à saumon
Cuchillo salmón

| art. | cm. | col. | € |
|----------|-----|------|-------|
| 18011-32 | 32 | ● | 19,80 |



Ham knife, scalloped edge

Coltello prosciutto, alveolato
Schinkenmesser mit Kullenschliff
Couteau à jambon alvéolé
Cuchillo para jamón alveolado

| art. | cm. | col. | € |
|----------|-----|------|-------|
| 18010-25 | 25 | ● | - |
| 18010-30 | 30 | ● | 21,81 |
| 18010-36 | 36 | ● | 23,92 |



Ham knife, scalloped edge

Coltello prosciutto, alveolato
Schinkenmesser mit Kullenschliff
Couteau à jambon alvéolé
Cuchillo para jamón alveolado

| art. | cm. | col. | € |
|----------|-----|------|-------|
| 18010Y30 | 30 | ● | 21,81 |



Salmon knife, scalloped edge

Coltello salmone, alveolato
Lachsmesser mit Kullenschliff
Couteau à saumon alvéolé
Cuchillo salmón alveolado

| art. | cm. | col. | € |
|----------|-----|------|-------|
| 18012-32 | 32 | ● | 23,22 |



Salmon knife, scalloped edge

Coltello salmone, alveolato
Lachsmesser mit Kullenschliff
Couteau à saumon alvéolé
Cuchillo salmón alveolado

| art. | cm. | col. | € |
|----------|-----|------|-------|
| 18012B32 | 32 | ● | 23,22 |



Cheese slicer

Coltello salati/formaggio
Universalmesser
Couteau universel
Cuchillo universal

| art. | cm. | col. | € |
|----------|-----|------|-------|
| 18013-30 | 30 | ● | 25,73 |
| 18013-36 | 36 | ● | 33,77 |



Cheese slicer
Coltello salati/formaggio
Universalmesser
Couteau universel
Cuchillo universal

| art. | cm. | col. | € |
|----------|-----|------|-------|
| 18013G36 | 36 | ● | 33,77 |

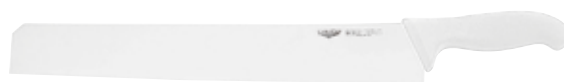

Cheese slicer
Coltello salati/formaggio
Universalmesser
Couteau universel
Cuchillo universal

| art. | cm. | col. | € |
|----------|-----|------|-------|
| 18013W30 | 30 | ○ | 25,73 |
| 18013W36 | 36 | ○ | 33,77 |



Filetting knife
Coltello filettare
Filiermesser
Couteau filet de sole
Cuchillo fileteador

| art. | cm. | col. | € |
|----------|-----|------|-------|
| 18015-18 | 18 | ● | 15,98 |
| 18015-22 | 22 | ● | 17,79 |
| 18015-27 | 27 | ● | 26,43 |



Filetting knife
Coltello filettare
Filiermesser
Couteau filet de sole
Cuchillo fileteador

| art. | cm. | col. | € |
|----------|-----|------|-------|
| 18015B18 | 18 | ● | 15,98 |
| 18015B22 | 22 | ● | 17,79 |



Filetting knife
Coltello filettare
Filiermesser
Couteau filet de sole
Cuchillo fileteador

| art. | cm. | col. | € |
|----------|-----|------|-------|
| 18015R22 | 22 | ● | 17,79 |



Filetting knife
Coltello filettare
Filiermesser
Couteau filet de sole
Cuchillo fileteador

| art. | cm. | col. | € |
|----------|-----|------|-------|
| 18015Y18 | 18 | ● | 15,98 |
| 18015Y27 | 27 | ● | 26,43 |



Boning knife
Coltello disosso
Ausbeinmesser
Couteau à désosser
Cuchillo deshuesador

| art. | cm. | col. | € |
|----------|-----|------|-------|
| 18016-14 | 14 | ● | 14,17 |
| 18016-16 | 16 | ● | 15,08 |



Boning knife
Coltello disosso
Ausbeinmesser
Couteau à désosser
Cuchillo deshuesador

| art. | cm. | col. | € |
|----------|-----|------|-------|
| 18016B14 | 14 | ● | 14,17 |
| 18016B16 | 16 | ● | 15,08 |



Boning knife
Coltello disosso
Ausbeinmesser
Couteau à désosser
Cuchillo deshuesador

| art. | cm. | col. | € |
|----------|-----|------|-------|
| 18016R14 | 14 | ● | 14,17 |
| 18016R16 | 16 | ● | 15,08 |



Boning knife
Coltello disosso
Ausbeinmesser
Couteau à désosser
Cuchillo deshuesador

| art. | cm. | col. | € |
|----------|-----|------|---|
| 18016W16 | 16 | ○ | - |



Boning knife

Coltello disosso
Ausbeinmesser
Couteau à désosser
Cuchillo deshuesador

| art. | cm. | col. | € |
|----------|-----|------|-------|
| 18016Y14 | 14 | ● | 14,17 |
| 18016Y16 | 16 | ● | 15,08 |



Boning knife

Coltello disosso Emilia
Ausbeinmesser
Couteau à désosser
Cuchillo deshuesador

| art. | cm. | col. | € |
|----------|-----|------|-------|
| 18017-14 | 14 | ● | 15,08 |
| 18017-16 | 16 | ● | 15,58 |
| 18017-18 | 18 | ● | 16,98 |



Boning knife

Coltello disosso Emilia
Ausbeinmesser
Couteau à désosser
Cuchillo deshuesador

| art. | cm. | col. | € |
|----------|-----|------|-------|
| 18017B16 | 16 | ● | 15,58 |
| 18017R16 | 16 | ● | 15,58 |
| 18017Y16 | 16 | ● | 15,58 |



Poultry sticking knife

Coltello scannapoli
Geflügelschlachtmesser
Couteau à volaille
Cuchillo deshuesador

| art. | cm. | col. | € |
|----------|-----|------|-------|
| 18018-11 | 11 | ● | 13,77 |
| 18018R11 | 11 | ● | 13,77 |
| 18018Y11 | 11 | ● | 13,77 |



Sticking knife

Coltello scannare
Stechmesser
Couteau à saigner
Cuchillo deshuesador

| art. | cm. | col. | € |
|----------|-----|------|-------|
| 18019-12 | 12 | ● | - |
| 18019-14 | 14 | ● | 12,46 |
| 18019-16 | 16 | ● | 16,48 |
| 18019-18 | 18 | ● | 18,79 |
| 18019-20 | 20 | ● | 21,81 |



Sticking knife

Coltello scannare
Stechmesser
Couteau à saigner
Cuchillo deshuesador

| art. | cm. | col. | € |
|----------|-----|------|-------|
| 18019R12 | 12 | ● | 11,76 |
| 18019R16 | 16 | ● | 16,48 |
| 18019R20 | 20 | ● | 21,81 |



Frozen food, two serrated edges

Coltello surgelati a doppia lama seghettata
Tiefkühlkost-Messer
Couteau à surgelés
Cuchillo de congelado

| art. | cm. | col. | € |
|----------|-----|------|-------|
| 18020-23 | 23 | ● | - |
| 18020B23 | 23 | ● | 20,10 |
| 18020R23 | 23 | ● | 20,10 |



Frozen food special serrated blade

Coltello surgelati lama seghettata speciale
Tiefkühlkost-Messer
Couteau à surgelés
Cuchillo de congelado

| art. | cm. | col. | € |
|----------|-----|------|-------|
| 18021-18 | 18 | ● | 16,48 |
| 18021B18 | 18 | ● | 16,48 |
| 18021R18 | 18 | ● | 16,48 |



Steak knife

Coltello bistecca
Steakmesser
Couteau à steak
Cuchillo para steak

| art. | cm. | col. | € |
|----------|-----|------|------|
| 18022-12 | 12 | ● | 6,93 |



Table knife, half-waved

Coltello tavola, mezzo dentato
Tafelmesser halb gewellt
Couteau universel, demi-dentelée
Cuchillo mesa, medio dentado

| art. | cm. | col. | € |
|----------|-----|------|------|
| 18023-11 | 11 | ● | 5,93 |



Steak/Pizza knife

Coltello bistecca/pizza
Steak-/Pizzamesser
Couteau à steak/pizza
Cuchillo para steak/pizza

| art. | cm. | U. Pack | col. | € |
|----------|-----|---------|------|------|
| 18217-12 | 12 | 6 | ● | 2,71 |



Paring knife

Spelucchino
Spickmesser
Couteau d'office
Cuchillo mondador

| art. | cm. | col. | € |
|----------|-----|------|------|
| 18024-08 | 8 | ● | 5,13 |
| 18024-11 | 11 | ● | 6,03 |



Paring knife

Spelucchino
Spickmesser
Couteau d'office
Cuchillo mondador

| art. | cm. | col. | € |
|----------|-----|------|------|
| 18024B08 | 8 | ● | 5,13 |
| 18024B11 | 11 | ● | 6,03 |



Paring knife

Spelucchino
Spickmesser
Couteau d'office
Cuchillo mondador

| art. | cm. | col. | € |
|----------|-----|------|------|
| 18024G08 | 8 | ● | 5,13 |
| 18024G11 | 11 | ● | 6,03 |



Paring knife

Spelucchino
Spickmesser
Couteau d'office
Cuchillo mondador

| art. | cm. | col. | € |
|----------|-----|------|------|
| 18024M08 | 8 | ● | 5,13 |
| 18024M11 | 11 | ● | 6,03 |



Paring knife

Spelucchino
Spickmesser
Couteau d'office
Cuchillo mondador

| art. | cm. | col. | € |
|----------|-----|------|------|
| 18024R08 | 8 | ● | 5,13 |
| 18024R11 | 11 | ● | 6,03 |



Paring knife

Spelucchino
Spickmesser
Couteau d'office
Cuchillo mondador

| art. | cm. | col. | € |
|----------|-----|------|------|
| 18024W08 | 8 | ○ | 5,13 |
| 18024W11 | 11 | ○ | 6,03 |



Paring knife

Spelucchino
Spickmesser
Couteau d'office
Cuchillo mondador

| art. | cm. | col. | € |
|----------|-----|------|------|
| 18024Y08 | 8 | ● | 5,13 |



Bent paring knife

Coltello cuoco
Tourniermesser
Couteau bec d'oiseau
Cuchillo para pelar

| art. | cm. | col. | € |
|----------|-----|------|------|
| 18026-07 | 7 | ● | 5,13 |
| 18026B07 | 7 | ● | 5,13 |



Bent paring knife

Coltello cuoco
Tourniermesser
Couteau bec d'oiseau
Cuchillo para pelar

| art. | cm. | col. | € |
|----------|-----|------|------|
| 18026G07 | 7 | ● | 5,13 |
| 18026M07 | 7 | ● | - |



Confectioner's knife

Coltello pasticceria
Bächrmesser
Couteau de pâtissier
Cuchillo de pastelero

| art. | cm. | col. | € |
|----------|-----|------|-------|
| 18029-25 | 25 | ● | 15,38 |
| 18029-30 | 30 | ● | 15,48 |
| 18029-36 | 36 | ● | 16,88 |



Confectioner's knife

Coltello pasticceria
Bächrmesser
Couteau de pâtissier
Cuchillo de pastelero

| art. | cm. | col. | € |
|----------|-----|------|-------|
| 18029W30 | 30 | ○ | 15,48 |
| 18029W36 | 36 | ○ | 16,88 |





Bread knife
Coltello pane
Brotmesser
Couteau à pain
Cuchillo para pan

| art. | cm. | col. | € |
|----------|-----|------|-------|
| 18028-21 | 21 | ● | 14,77 |



Bread knife
Coltello pane
Brotmesser
Couteau à pain
Cuchillo para pan

| art. | cm. | col. | € |
|----------|-----|------|-------|
| 18028-25 | 25 | ● | 20,80 |
| 18028-30 | 30 | ● | 23,01 |
| 18028-36 | 36 | ● | 28,24 |



Bread knife
Coltello pane
Brotmesser
Couteau à pain
Cuchillo para pan

| art. | cm. | col. | € |
|----------|-----|------|---|
| 18028B30 | 30 | ● | - |



Bread knife
Coltello pane
Brotmesser
Couteau à pain
Cuchillo para pan

| art. | cm. | col. | € |
|----------|-----|------|-------|
| 18028M25 | 25 | ● | 20,80 |



Bread knife
Coltello pane
Brotmesser
Couteau à pain
Cuchillo para pan

| art. | cm. | col. | € |
|----------|-----|------|-------|
| 18028W21 | 21 | ○ | 14,77 |
| 18028W25 | 25 | ○ | 20,80 |
| 18028W30 | 30 | ○ | 23,01 |
| 18028W36 | 36 | ○ | 28,24 |



Bread knife
Coltello pane
Brotmesser
Couteau à pain
Cuchillo para pan

| art. | cm. | col. | € |
|----------|-----|------|-------|
| 18028Y25 | 25 | ● | 20,80 |
| 18028Y30 | 30 | ● | 23,01 |



Pastry knife
Coltello dolce
Bäckermesser
Couteau de pâtissier
Cuchillo de pastelero

| art. | cm. | col. | € |
|----------|-----|------|-------|
| 18030-26 | 26 | ● | 16,78 |
| 18030-31 | 31 | ● | 19,50 |
| 18030-36 | 36 | ● | 20,70 |



Pastry knife
Coltello dolce
Bäckermesser
Couteau de pâtissier
Cuchillo de pastelero

| art. | cm. | col. | € |
|----------|-----|------|-------|
| 18030W26 | 26 | ○ | 16,78 |
| 18030W31 | 31 | ○ | 19,50 |
| 18030W36 | 36 | ○ | 20,70 |

SPECIAL ITEMS
PEZZI SPECIALI



Chinese meat cleaver
Falcetta cinese
Chinesishackmesser
Couteau de chef chinois
Macheta Chino

| art. | cm. | col. | € |
|----------|-----|------|-------|
| 18221-17 | 17 | ● | 33,37 |
| 18221-19 | 19 | ● | 36,18 |
| 18221-21 | 21 | ● | - |



Chinese meat cleaver
Falcetta cinese
Chinesishackmesser
Couteau de chef chinois
Macheta Chino

| art. | cm. | col. | € |
|----------|-----|------|-------|
| 18221B17 | 17 | ● | 33,37 |
| 18221B19 | 19 | ● | 36,18 |
| 18221B21 | 21 | ● | 40,20 |



Chinese meat cleaver
Falcetta cinese
Chinesishackmesser
Couteau de chef chinois
Macheta Chino

| art. | cm. | col. | € |
|----------|-----|------|-------|
| 18221G17 | 17 | ● | 33,37 |
| 18221G19 | 19 | ● | 36,18 |
| 18221G21 | 21 | ● | - |



Chinese meat cleaver
Falcetta cinese
Chinesishackmesser
Couteau de chef chinois
Macheta Chino

| art. | cm. | col. | € |
|----------|-----|------|-------|
| 18221M17 | 17 | ● | 33,37 |
| 18221M19 | 19 | ● | 36,18 |
| 18221M21 | 21 | ● | - |



Chinese meat cleaver

Falcetta cinese
Chinesishackmesser
Couteau de chef chinois
Macheta Chino

| art. | cm. | col. | € |
|----------|-----|------|-------|
| 18221R17 | 17 | ● | 33,37 |
| 18221R19 | 19 | ● | 36,18 |
| 18221R21 | 21 | ● | - |



Chinese meat cleaver

Falcetta cinese
Chinesishackmesser
Couteau de chef chinois
Macheta Chino

| art. | cm. | col. | € |
|----------|-----|------|-------|
| 18221Y17 | 17 | ● | 33,37 |
| 18221Y19 | 19 | ● | 36,18 |
| 18221Y21 | 21 | ● | - |



Meat cleaver

Falcetta macellaio
Hackmesser
Couperet
Macheta

| art. | cm. | Kg. | col. | € |
|----------|-----|------|------|-------|
| 18220-18 | 18 | 0,55 | ● | 30,15 |
| 18220-20 | 20 | 1,10 | ● | 49,55 |
| 18220-22 | 22 | 1,30 | ● | 58,19 |
| 18220-26 | 26 | 1,30 | ● | 60,50 |



Meat cleaver

Falcetta macellaio
Hackmesser
Couperet
Macheta

| art. | cm. | Kg. | col. | € |
|----------|-----|------|------|-------|
| 18220B18 | 18 | 0,55 | ● | 30,15 |
| 18220B20 | 20 | 1,10 | ● | 49,55 |
| 18220B22 | 22 | 1,30 | ● | 58,19 |
| 18220B26 | 26 | 1,30 | ● | 60,50 |



Meat cleaver

Falcetta macellaio
Hackmesser
Couperet
Macheta

| art. | cm. | Kg. | col. | € |
|----------|-----|------|------|-------|
| 18220R18 | 18 | 0,55 | ● | 30,15 |
| 18220R20 | 20 | 1,10 | ● | 49,55 |
| 18220R22 | 22 | 1,30 | ● | 58,19 |
| 18220R26 | 26 | 1,30 | ● | 60,50 |



Meat cleaver

Falcetta macellaio
Hackmesser
Couperet
Macheta

| art. | cm. | Kg. | col. | € |
|----------|-----|------|------|-------|
| 18220Y18 | 18 | 0,55 | ● | 30,15 |
| 18220Y20 | 20 | 1,10 | ● | 49,55 |
| 18220Y22 | 22 | 1,30 | ● | 58,19 |
| 18220Y26 | 26 | 1,30 | ● | 60,50 |



Heavy butcher's knife

Mezzo colpo
Kochschlagmesser
Couteau coup lourd
Cuchillo de carnicero

| art. | cm. | Kg. | col. | € |
|----------|-----|------|------|-------|
| 18224-28 | 28 | 0,75 | ● | 44,12 |
| 18224B28 | 28 | 0,75 | ● | 44,12 |
| 18224R28 | 28 | 0,75 | ● | 44,12 |
| 18224Y28 | 28 | 0,75 | ● | 44,12 |



Heavy butcher's knife

Colpo
Kochschlagmesser
Couteau coup lourd
Cuchillo de carnicero

| art. | cm. | Kg. | col. | € |
|----------|-----|-----|------|-------|
| 18225-28 | 28 | 1 | ● | 48,54 |
| 18225R28 | 28 | 1 | ● | 48,54 |



Parmesan cheese knife

Coltello grana
Parmesanmesser
Couteau à Parmesan
Cuchillo Para Queso Parmenoso

| art. | cm. | col. | € |
|----------|-----|------|-------|
| 18205-10 | 10 | ● | 12,46 |



Parmesan cheese knife

Coltello grana
Parmesanmesser
Couteau à Parmesan
Cuchillo Para Queso Parmenoso

| art. | cm. | col. | € |
|----------|-----|------|-------|
| 18205-12 | 12 | ● | 17,69 |



Parmesan cheese knife

Coltello segnaforme
Parmesanmesser
Couteau à Parmesan
Cuchillo Para Queso Parmenoso

| art. | cm. | col. | € |
|----------|-----|------|-------|
| 18206-09 | 9 | ● | 16,88 |



Parmesan cheese knife

Coltello lancia Milano
Parmesanmesser
Couteau à Parmesan
Cuchillo Para Queso Parmenoso

| art. | cm. | col. | € |
|----------|-----|------|-------|
| 18207-15 | 15 | ● | 20,30 |



Oyster knife

Coltello apriostriche
Austermesser
Couteau à huîtres
Cuchillo para ostras

| art. | cm. | col. | € |
|----------|-----|------|------|
| 18209-06 | 15 | ● | 4,92 |



Cheese knife 2 handles

Coltello formaggio
Käsemesser
Couteau à fromage
Cuchillo para queso

| art. | cm. | col. | € |
|----------|-----|------|-------|
| 18201-36 | 36 | ● | 57,79 |



Vegetable knife

Coltello verdure
Gemüsemesser
Couteau à légumes
Cuchillo para verduras

| art. | cm. | col. | € |
|----------|-----|------|-------|
| 18222-18 | 18 | ● | 24,62 |



Ham boner

Cannula disosso prosciutti
Schinkenauslöser
Gouge à jambons
Cuchillo deshuesar jamón

| art. | cm. | col. | € |
|----------|-----|------|-------|
| 48021-21 | 21 | ● | 60,20 |



Cheese knife

Coltello formaggio
Käsemesser
Couteau à fromage
Cuchillo para queso

| art. | cm. | col. | € |
|----------|-----|------|-------|
| 18203-26 | 26 | ● | 24,82 |



Baking pan knife

Coltello gastronomia
Winkelmesser
Couteau à angle
Cuchillo hoja angular

| art. | cm. | col. | € |
|----------|------|------|-------|
| 18215-13 | 13,5 | ● | 19,80 |



Baking pan knife

Coltello gastronomia
Winkelmesser
Couteau à angle
Cuchillo hoja angular

| art. | cm. | col. | € |
|----------|------|------|-------|
| 18215-21 | 21,5 | ● | 23,22 |



Pie knife

Coltello torta
Tortenmesser
Couteau à gâteau
Cuchillo para tartas

| art. | cm. | col. | € |
|----------|-----|------|---|
| 18514-18 | 18 | ● | - |





Mincing knife

Mezzaluna
Wiegemesser
Hachoir
Media luna

| art. | cm. | col. | € |
|----------|-----|------|-------|
| 48017-14 | 14 | ● | 13,77 |
| 48017-25 | 26 | ● | 31,05 |



Double blade mincing knife

Mezzaluna, lama doppia
Wiegemesser, Doppel-Klinge
Hachoir double lame
Media luna, doble

| art. | cm. | col. | € |
|----------|-----|------|-------|
| 48215-14 | 14 | ● | 16,08 |
| 48215-30 | 30 | ● | 51,66 |



Meat fork

Forchettone
Fleischgabel
Fourchette baïonnette
Tenedor Trinchante

| art. | cm. | col. | € |
|----------|-----|------|-------|
| 18226-17 | 17 | ● | 10,45 |
| 18226B17 | 17 | ● | 10,45 |
| 18226G17 | 17 | ● | 10,45 |



Meat fork

Forchettone
Fleischgabel
Fourchette baïonnette
Tenedor Trinchante

| art. | cm. | col. | € |
|----------|-----|------|-------|
| 18226R17 | 17 | ● | - |
| 18226W17 | 17 | ○ | - |
| 18226Y17 | 17 | ● | 10,45 |



Sharpening steel

Acciaino
Wetzstahl
Fusil
Chaira

| art. | cm. | col. | € |
|----------|-----|------|-------|
| 18235-26 | 26 | ● | 32,06 |



Sharpening steel

Acciaino
Wetzstahl
Fusil
Chaira

| art. | cm. | col. | € |
|----------|-----|------|-------|
| 18235-30 | 30 | ● | 34,77 |
| 18235B30 | 30 | ● | 34,77 |
| 18235G30 | 30 | ● | 34,77 |



Sharpening steel

Acciaino
Wetzstahl
Fusil
Chaira

| art. | cm. | col. | € |
|----------|-----|------|-------|
| 18235R30 | 30 | ● | 34,77 |
| 18235W30 | 30 | ○ | 34,77 |
| 18235Y30 | 30 | ● | 34,77 |



Oval sharpening steel

Acciaino ovale
Wetzstahl, oval
Fusil ovale
Chaira ovalada

| art. | cm. | col. | € |
|----------|-----|------|-------|
| 18236-30 | 30 | ● | 51,66 |



Diamond sharpening steel

Acciaino diamantato
Diamant-Wetzstahl
Fusil diamant
Chaira adiamantada

| art. | cm. | col. | € |
|----------|-----|------|-------|
| 18237-26 | 26 | ● | 47,64 |



Sharpening stone GRIT 1000/240

Pietra per affilare
Abziehstein
Pierre à aiguiser
Piedra de afilar

| art. | cm. | € |
|----------|--------|-------|
| 18251-01 | 21x7x3 | 22,51 |



Sharpening stone GRIT 1000/600

Pietra per affilare
Abziehstein
Pierre à aiguiser
Piedra de afilar

| art. | cm. | € |
|----------|--------|-------|
| 18251-02 | 21x7x3 | 22,71 |



Poultry shears

Trinciapollo
Geflügelschere
Coupe-volailles
Tijeras aves

| art. | cm. | € |
|----------|-----|-------|
| 18263-00 | 25 | 14,87 |



Poultry scissors, divisible

Forbice pollame, smontabile
Geflügelschere, teilbar
Coupe-volailles divisible
Tijeras aves, desmontables

| art. | cm. | € |
|----------|------|------|
| 18275-00 | 26,5 | 5,43 |



Poultry shears, divisible

Trinciapollo, smontabile
Geflügelschere, teilbar
Coupe-volailles divisible
Tijeras aves, desmontables

| art. | cm. | € |
|----------|-----|-------|
| 18261-00 | 24 | 47,54 |



Seafood scissors

Forbice gamberi
Meeresfrüchteschere
Ciseaux à crevettes
Tijeras camarónes

| art. | cm. | € |
|----------|-----|------|
| 18278-00 | 18 | 4,82 |



Herb scissors, 5 blades

Forbice erbe, 5 lame
Kräuterschere 5 Klingen
Ciseaux à herbes 5 lames
Tijeras hierbas 5 Cuchillas

| art. | cm. | € |
|----------|-----|------|
| 18277-00 | 20 | 8,04 |



Salad scissors

Forbice insalata
Salatschere
Ciseaux à salade
Tijeras ensalada

| art. | cm. | € |
|----------|-----|------|
| 18270-22 | 22 | 9,25 |



Quail egg cutter

Forbice uova di quaglia
Wachteleierschere
Ciseaux oeufs de caille
Tijeras huevos de codorniz

| art. | cm. | € |
|----------|-----|------|
| 18279-14 | 14 | 2,71 |



All purpose scissors

Forbice multiuso
Küchenschere
Ciseaux de cuisine
Tijeras cocina

| art. | cm. | € |
|----------|------|------|
| 18272-00 | 18,5 | 3,12 |



Kitchen scissors, divisible

Forbice cucina, smontabile
Küchenschere, teilbar
Ciseaux de cuisine, divisible
Tijeras cocina, desmontables

| art. | cm. | € |
|----------|------|------|
| 18271-00 | 22,6 | 7,14 |



Kitchen scissors, divisible

Forbice cucina, smontabile
Küchenschere, teilbar
Ciseaux de cuisine, divisible
Tijeras cocina, desmontables

| art. | cm. | € |
|----------|-----|-------|
| 18273-00 | 18 | 28,04 |



Kitchen scissors, divisible

Forbice cucina, smontabile
Küchenschere, teilbar
Ciseaux de cuisine, divisible
Tijeras cocina, desmontables

| art. | cm. | € |
|----------|-----|-------|
| 18274-00 | 20 | 31,36 |



Chinese kitchen scissors

Forbice cinese cucina
Chinesische Küchenschere
Ciseaux chinois de cuisine
Tijeras chinas de cocina

| art. | cm. | € |
|----------|--------|-------|
| 49636-00 | 17x8,5 | 10,25 |



Pizza scissors, divisible

Forbice pizza, smontabile
Pizzaschere, teilbar
Ciseaux à pizza, divisible
Tijeras pizza, desmontables

| art. | cm. | € |
|----------|-----|------|
| 18276-00 | 25 | 7,54 |

Stainless steel and brass. – Inox e ottone.



JAPANESE SUSHI KNIVES COLTELLI SUSHI GIAPPONESI

KNIVES
COLTELLERIA



Excellent choice when preparing sushi and vegetables. Molybdenum/ Vanadium s/s blades for excellent edge retention, razor sharp edges, slip resistant wooden handles. The blades are sharpened with the traditional Japanese single bevel to improve sharpness. The large beveled one-sided edge is much thinner than a two-sided edge. This thinner, sharper edge makes for cleaner cuts through the soft flesh of fish, in particular. Using these knives will avoid bruising the delicate texture of raw fish and destroying the freshness of the fish. The thinner edge is more fragile than the edge on western knives. Do not use for cutting anything solid including larger fish bones. Due to the special blade sharpening and s/s used we highly recommend to only hand wash and dry the blades thoroughly immediately.

Una scelta eccellente per la preparazione di sushi e verdure. Lame in acciaio inox, molibdeno e vanadio, per un'ottimale tenuta del filo, affilatura a rasoio, manici in legno antiscivolo. Secondo la tradizione giapponese l'affilatura è unilaterale ed il filo è molto più sottile rispetto a quello della normale affilatura dei coltelli occidentali. Questo rende i tagli più nitidi ed evita di creare traumi alla trama delicata di carne e pesce crudo. Non utilizzare per il taglio di solidi incluse grosse lisce di pesce. Data la particolarità dell'affilatura e dell'acciaio impiegato si consiglia vivamente di lavare a mano ed asciugare immediatamente con cura le lame.



DEBA

| art. | l. cm. | € |
|----------|--------|-------|
| 18280-22 | 22,5 | 44,12 |
| 18280-16 | 16,5 | 34,97 |
| 18280-10 | 10,5 | 29,04 |

The Deba is a powerful knife used for filleting fish and butchering meat without bones. Its weight and thickness can chop through fish bones and the sharp edge can fillet even the smallest of fish. – Affilato e dalla lama pesante usato per disossare e tagliare il pesce utilizzato nel sushi. È simile ad un coltello da chef.



OROSHI

| art. | l. cm. | € |
|----------|--------|-------|
| 18281-24 | 24 | 46,93 |

An Oroshi Knife is a Japanese all-purpose cooking knife, but used particularly for fish. – Per sfilettare il tonno e altri pesci di grandi dimensioni.



USUBA

| art. | l. cm. | € |
|-----------|--------|-------|
| 18282-22 | 22,5 | 50,55 |
| 18282-18 | 18,0 | 37,19 |
| 18282-19* | 18,0 | 29,04 |

***Double bevel. The Usuba is the ultimate vegetable knife. Sharp and thin, it is used by chefs in Japan for katsuramuki, a traditional style of peeling vegetables into thin sheets.** – *Doppia affilatura. Coltello estremamente affilato con una punta quadrata. Questo coltello è usato per tagliare verdure e quando è tenuto ben affilato può tagliarle in fette sottili come un foglio di carta.



TAKO SASHIMI

| art. | l. cm. | € |
|----------|--------|-------|
| 18283-33 | 33 | 38,79 |
| 18283-27 | 27 | 34,27 |

The Tako Sashimi is a variation of the Yanagi and is used to slice straight-cut sashimi. The blunt tip and balanced weight works well on difficult ingredients like octopus, from which it gets its name. Originated in Kanto (Tokyo) region. – Il coltello Tako Sashimi assomiglia di più ad un coltello occidentale ed è utilizzato per affettare tagli spessi di carne per sushi. Ha la lama senza punta, per evitare di rovinare i tentacoli del polpo.



YANAGI SASHIMI

| art. | l. cm. | € |
|----------|--------|-------|
| 18284-21 | 21 | 32,56 |
| 18284-27 | 27 | 36,38 |
| 18284-30 | 30 | 38,49 |
| 18284-33 | 33 | 40,70 |

The Yanagi Sashimi is a slicing knife used to cut boneless fish fillets into sashimi and topping for sushi. The graceful, thin blade cuts beautiful slices in one long, drawing stroke. Originated in Kansai (Osaka) region. – Viene utilizzato per tagliare sottili fette di verdure, carne o pesce, nonché per tagliare in generale a dadi o a fette. Grazie alla sua lama sottile ed affilata è utilizzato anche per creare guarnizioni o tagliare i rotoli di sushi.



Knife case, 14 pieces

Valigia cuoco, 14 pz.
Messerkoffer, 14 Stk.
Mallette de chef, 14 pièces
Maleta cuchillos, 14 piezas

| art. | des. | € |
|----------|--------------------------------|--------|
| 18099-15 | Comprende/includes: | 388,03 |
| 18000-26 | cook's knife/cucina cm 26 | |
| 18000-30 | cook's knife/cucina cm 30 | |
| 18002-18 | butcher's knife/francese cm 18 | |
| 18002-26 | butcher's knife/francese cm 26 | |
| 18009-30 | ham/prosciutto cm 30 | |
| 18016-16 | boning/disosso cm 6 | |
| 18024-11 | paring/spelucchino cm 11 | |
| 18026-07 | paring/spelucchino cm 7 | |
| 18028-30 | bread/pane cm 30 | |
| 18230-17 | fork/forchettone cm 17 | |
| 18235-30 | sharpener/acciaino cm 30 | |
| 18519-26 | spatula/spatola cm 26 | |
| 48280-34 | peeler/pelapatate | |
| 18276-00 | scissors/forbice pizza | |

Knife case, 19 pcs

Valigia cuoco, 19 pz.
Messerkoffer, 19 Stk.,
Mallette de chef, 19 pcs
Maleta cuchillos, 19 piezas

| art. | des. | € |
|----------|---|--------|
| 18199-19 | Comprende/includes: | 575,16 |
| 18100-24 | cook's knife/cucina cm 24 | |
| 18100-30 | cook's knife/cucina cm 30 | |
| 18112-30 | salmon/salmone cm 30 | |
| 18115-20 | filleting/filettare cm 20 | |
| 18116-14 | boning/disosso cm 14 | |
| 18125-10 | paring/spelucchino cm 10 | |
| 18126-07 | bent paring/spelucchino cm 7 | |
| 18128-30 | bread/pane cm 30 | |
| 18230-17 | fork/forchettone cm 17 | |
| 18235-30 | sharpener/acciaino cm 30 | |
| 18276-00 | scissors/forbice pizza | |
| 18255-00 | sharpener/affila coltelli | |
| 48280-25 | apple corer/levatorsoli | |
| 48280-34 | peeler/pelapatate | |
| 48280-02 | can opener/apribottiglie | |
| 48280-27 | melon baller/scavino | |
| 48280-92 | striper/decora limoni | |
| 48280-96 | orange peeler/pelarence | |
| 48286-67 | double melon baller/scavino doppio mm 22-30 | |



Manual sharpener
Affilacoltelli manuale
Messer Schleifapparat
Affûteur manuel
Afilador manual

| art. | cm. | € |
|----------|-----|-------|
| 18255-00 | 25 | 15,68 |



Manual sharpener
Affilacoltelli manuale
Messer Schleifapparat
Affûteur manuel
Afilador manual

| art. | cm. | € |
|----------|------------|-------|
| 49739-00 | 14,5x7x1,5 | 57,79 |



Salami pricker
Pungisalame
Salamistachel
Pique saucisson
Picadura para embutido

| art. | Ø cm. | € |
|----------|-------|------|
| 42523-00 | 7 | 9,85 |



Knife roll-bag, 9 pieces forged

Rotolo portacoltelli, 9 pz. forgiati
Messer-Rolltasche, 9-teilig
Rouleau pour couteaux, 9 pièces
Estuche cuchillos, 9 piezas

| art. | des. | € |
|----------|------------------------|--------|
| 18190-09 | Comprende/includes: | 392,25 |
| 18116-14 | boning/disosso cm 9 | |
| 18100-24 | cook's/cucina cm 24 | |
| 18106-25 | slicer/affettare cm 25 | |
| 18109-26 | ham/prosciutto cm 24 | |



| art. | des. |
|----------|--------------------|
| 18124-09 | paring/spelucchino |
| 18128-24 | bread/pane cm 14 |
| 18230-17 | fork/forchettone |
| 18235-26 | sharpener/acciaino |
| 18271-00 | scissors/forbice |



W

Knife block, 9 pcs set

Ceppo portacoltelli, set 9 pz
Messerblock, 9-tlg.
Bloc à couteaux, set 9 pièces
Bloque portacuchillos, 9 piezas

| art. | des. | € |
|----------|-------------------------|--------|
| 18192-09 | Comprende/includes: | 300,60 |
| 18100-20 | cook's/cucina cm 20 | |
| 18106-20 | slicer/affettare cm 20 | |
| 18124-09 | paring/spelucchino cm 9 | |
| 18128-20 | bread/pane cm 20 | |



| art. | des. |
|----------|--------------------------|
| 18230-17 | fork/forchettone cm 17 |
| 18235-26 | sharpener/acciaino cm 26 |
| 18271-00 | scissors/forbice |
| 18102-16 | butcher's/francese cm 16 |
| 18126-07 | paring/cuoco cm 7 |



Magnetic knife rack

Barra magnetica
Magnet-Messerhalter
Porte-couteaux magnetic
Barra magnética portas cuchillos

| art. | cm. | € |
|----------|-----|-------|
| 48032-30 | 30 | 11,96 |
| 48032-45 | 45 | 16,48 |
| 48032-60 | 60 | 19,60 |



SS

Edlund

Knife block

Ceppo porta coltelli
Messerblock
Bloc à couteaux
Bloque portacuchillos

| art. | cm. | € |
|----------|----------|--------|
| 49875-06 | 26x14x33 | 512,75 |



SS

Edlund

Knife rack

Porta coltelli
Messeraufhänger
Support à couteaux
Porta cuchillos

| art. | cm. | € |
|----------|---------------|--------|
| 48040-00 | 30,5x6,6x30,5 | 218,79 |

Holds 8 chef 's knives, 2 smaller knives, 1 steel and scissors. – Per 8 coltelli cuoco, 2 coltelli piccoli, 1 acciaio e forbici.



Knife rack

Porta coltelli
Messeraufhänger
Support à couteaux
Porta cuchillos

| art. | cm. | € |
|----------|---------------|--------|
| 48040-10 | 30,5x6,6x35,6 | 291,85 |

Holds 8 chef 's knives, 2 smaller knives, 1 steel and scissors. – Per 8 coltelli cuoco, 2 coltelli piccoli, 1 acciaino e forbici.



Knife rack

Porta coltelli
Messeraufhänger
Support à couteaux
Porta cuchillos

| art. | cm. | € |
|----------|---------------|--------|
| 48039-06 | 15,2x6,6x30,5 | 216,88 |

Holds 1 cleaver and 4 chef knives or 6 chef knives or 8 slicers or 12 paring knives and 1 round or diamond steel. – Per 1 mannaia e 4 coltelli cuoco o 6 coltelli cuoco o 8 coltelli affettare o 12 spelucchini e 1 acciaino tondo.



Knife sanitizing system

Sterilizzatore ad immersione
Messerentkeimer
Stérilisateur à couteaux
Esterilizador a inmersión

| art. | cm. | € |
|----------|----------------|--------|
| 48040-50 | 45,7x11,5x45,7 | 962,59 |



Larding needle with flap

Ago lardellare con becco
Spicknadel mit Klappe
Lardoire à clapet
Aguja para mechar

| art. | Ø mm. | cm. | € |
|----------|-------|-----|-------|
| 42514-20 | 5 | 20 | 15,68 |



Trussing needle straight

Ago da cucina
Dressiernadel
Aiguille à brider droite
Aguja para bridar

| art. | cm. | € |
|----------|-----|-------|
| 42515-18 | 18 | 10,25 |
| 42515-20 | 20 | 10,55 |



Trussing needle bent

Ago da cucina curvo
Dressiernadel gebogen
Aiguille à brider courbe
Aguja curva para bridar

| art. | cm. | € |
|----------|-----|-------|
| 42516-18 | 18 | 10,25 |
| 42516-20 | 20 | 11,06 |



Needles 5 pcs set

Aghi set 5 pz
Nadelsatz, 5 Stk.
Aiguilles set 5 pcs
Agujas 5 pz

| art. | € |
|----------|-------|
| 42517-06 | 63,01 |



Skewers, 100 pcs

Spiedini, 100 pz
Fleischspieße, 100 Stk
Brochettes, 100 pcs
Palos para asar, 100 pz

| art. | cm. | € |
|----------|-----|------|
| 48307-01 | 15 | 0,80 |
| 48307-02 | 20 | 1,31 |
| 48307-03 | 25 | 1,51 |



Skewers 6 pcs set

Spiedini set 6 pz
Fleischspieße, Satz 6 Stk
Brochettes set 6 pcs
Palos para asar 6 pz

| art. | cm. | € |
|----------|-----|-------|
| 42529-06 | 30 | 41,61 |



Skewers flat, 18/8

Spiedini piatti, 18/8
Fleischspieße, flach, 18/8
Brochettes plates, 18/8
Pinchos planos, 18/8

| art. | mm. | U. Pack | € |
|----------|-------|---------|------|
| 42511-20 | 200x3 | 10 | 0,80 |
| 42511-25 | 250x3 | 10 | 0,80 |
| 42511-30 | 300x3 | 10 | 0,80 |
| 42511-35 | 350x3 | 10 | 1,11 |
| 42511-40 | 400x3 | 10 | 1,41 |
| 42511-56 | 560x5 | 10 | 4,42 |



Swords, 18/8

Spade, 18/8
Schwerter, 18/8
Epées, 18/8
Espadas, 18/8

| art. | mm. | € |
|----------|----------|------|
| 42511-60 | 600x15x3 | 6,53 |
| 42511-70 | 700x15x3 | 6,83 |



SS

Anchor meat hook

Gancio ad ancora
Anker Fleischhaken
Esse à ancre
Gancho forma ancla

| art. | Ø mm. | cm. | U. Pack | € |
|----------|-------|-----|---------|------|
| 42507-12 | 7 | 13 | 10 | 2,51 |



SS

Sliving meat hook

Gancio girevole
Fleischdrehhaken
Esse-tournante
Gancho giratorio

| art. | Ø mm. | cm. | U. Pack | € |
|----------|-------|-----|---------|-------|
| 42525-27 | 12 | 27 | 10 | 21,81 |



SS

Meat hook, 2 peaks

Gancio fisso, 2 punte
Fleischhaken, 2 Spitze
Crochet esse, 2 pointes
Gancho 2 puntas

| art. | Ø mm. | cm. | U. Pack | € |
|----------|-------|-----|---------|------|
| 42524-06 | 3 | 6 | 10 | 0,50 |
| 42524-08 | 4 | 8 | 10 | 0,80 |
| 42524-10 | 4 | 10 | 10 | 0,80 |
| 42524-12 | 5 | 12 | 10 | 1,01 |
| 42524-14 | 5 | 14 | 10 | 1,01 |
| 42524-16 | 6 | 16 | 10 | 1,31 |
| 42524-18 | 6 | 18 | 10 | 1,31 |
| 42524-20 | 9 | 20 | 10 | 3,62 |
| 42524-22 | 9 | 22 | 10 | 3,32 |
| 42524-30 | 12 | 30 | 10 | 7,04 |



SS

Meat hook, 1 peak

Gancio fisso, 1 punta
Fleischhaken, 1 Spitze
Crochet esse, 1 pointe
Gancho 1 punta

| art. | Ø mm. | cm. | U. Pack | € |
|----------|-------|-----|---------|------|
| 42506-08 | 3 | 8 | 10 | 0,60 |
| 42506-10 | 4 | 10 | 10 | 0,80 |
| 42506-12 | 5 | 12 | 10 | 1,01 |
| 42506-14 | 5 | 14 | 10 | 1,01 |
| 42506-16 | 6 | 16 | 10 | 1,31 |
| 42506-18 | 6 | 18 | 10 | 1,41 |



SS

Swivel meat hook

Gancio girevole
Fleischdrehhaken
Esse-tournante
Gancho giratorio

| art. | Ø mm. | cm. | € |
|----------|-------|-----|-------|
| 42505-21 | 9 | 22 | 9,75 |
| 42505-24 | 10 | 24 | 11,36 |
| 42505-27 | 12 | 27 | 12,96 |
| 42505-50 | 12 | 50 | 16,38 |



SS

Sliding meat hook

Gancio scorrevole
Fleischhaken
Crochet coulissant
Gancho

| art. | Ø mm. | cm. | U. Pack | € |
|----------|-------|-----|---------|-------|
| 42526-12 | 9 | 12 | 10 | 12,26 |
| 42526-14 | 12 | 14 | 10 | 13,77 |



SS

Ham tongs

Pinza per affettati
Schinkenlange
Pince à jambon
Pinza para jamón

| art. | cm. | € |
|----------|------|------|
| 42510-00 | 11x6 | 5,53 |



SS

Meat tenderizer
Batticarne a pugno
Kotelettklopfen
Aplatisseur
Aplasta carnes

| art. | Kg. | € |
|----------|-----|-------|
| 42501-15 | 1,5 | 50,65 |
| 42501-20 | 2,0 | 62,81 |



SS

Meat tenderizer
Batticarne a due tagli
Kotelettklopfen
Aplatisseur
Aplasta carnes

| art. | Kg. | € |
|----------|-----|--------|
| 42502-11 | 1,1 | 123,72 |



SS

Meat tenderizer
Batticarne a paletta
Kotelettklopfen
Aplatisseur
Aplasta carnes

| art. | Kg. | € |
|----------|-----|--------|
| 42503-10 | 1 | 118,19 |



Steak hammer, aluminum
Batticarne, alluminio
Aluminum-Fleischklopfen
Attendrisseur, alu
Aplasta carnes, aluminio

| art. | cm. | Kg. | € |
|----------|-----|-----|-------|
| 42508-00 | 32 | 0,6 | 35,07 |



Steak hammer, aluminum
Batticarne, alluminio
Aluminum-Fleischklopfen
Attendrisseur, alu
Aplasta carnes, aluminio

| art. | cm. | Kg. | € |
|----------|-----|------|-------|
| 42508-01 | 25 | 0,41 | 12,06 |



SS

Bone-saw
Sega per ossa
Knochensäge
Scie à os
Sierra de cocina

| art. | cm. | € |
|----------|-----|-------|
| 48231-40 | 40 | 76,18 |
| 48231-45 | 45 | 79,50 |
| 48231-50 | 50 | 83,11 |



SS

String holder
Portaspago
Schnurrolle-Halter
Porte rolls sur socle
Porta cuerda

| art. | cm. | € |
|----------|----------|--------|
| 42579-00 | 19x12x17 | 111,96 |



SS

Meat pan
Vassoio rettangolare
Fleischblech
Plat boucher
Bandeja rectangular

| art. | cm. | € |
|----------|---------|-------|
| 42534-26 | 26x23x2 | 14,57 |
| 42534-32 | 34x21x2 | 14,37 |
| 42534-41 | 45x25x2 | 20,60 |



SS

Display tray
Vassoio espositore
Ausstellplatte
Plateau
Bandeja expositora

| art. | cm. | € |
|----------|---------|-------|
| 42532-29 | 29x21x2 | 13,57 |
| 42532-58 | 58x21x2 | 28,54 |



SS

Meat pan
Vassoio
Fleischblech
Plat boucher
Contenedor

| art. | cm. | € |
|----------|---------------|-------|
| 42530-26 | 24,4x21,6x5,5 | 17,89 |
| 42530-32 | 32x23x5,5 | 21,91 |
| 42530-41 | 41x31x5,5 | 30,55 |
| 42530-50 | 50x35x5,5 | 46,93 |



SS

Meat pan with grid
Vassoio con griglia
Fleischblech mit Siebeinsatz
Plat boucher avec grille
Contenedor con rejilla

| art. | cm. | € |
|----------|---------------|-------|
| 42531-26 | 24,4x21,6x5,5 | 24,72 |
| 42531-32 | 32x23x5,5 | 28,94 |
| 42531-41 | 41x31x5,5 | 42,11 |
| 42531-50 | 50x35x5,5 | 61,71 |



Ham stand on wood
Ferma prosciutto base legno
Schinkenhalter, Holzsockel
Pince à jambon sur bois
Jamonero, base madera

| art. | cm. | Kg. | € |
|----------|----------|-----|--------|
| 41582-00 | 24x45x16 | 4,5 | 209,24 |



Ham stand on marble

Ferma prosciutto base marmo
Schinkenhalter, Marmorsockel
Pince à jambon sur marbre
Jamonero, base mármol

| art. | cm. | Kg. | € |
|----------|----------|------|--------|
| 41583-00 | 24x45x15 | 10,3 | 300,50 |



SS

Hamburger press

Pressa-hamburger
Hamburgerpresse
Moule à steak
Prensa para hamburguesa

| art. | Ø cm. | l. cm. | € |
|----------|-------|--------|-------|
| 42864-10 | 10 | 36 | 89,55 |



Hamburger press, anodized aluminum

Pressa-hamburger, alluminio anodizzato
Hamburgerpresse, Aluminium eloxiert
Moule à steak, aluminium anodisé
Prensa para hamburguesa, aluminio anodizado

| art. | cm. | Kg. | € |
|----------|------------|-----|--------|
| 49978-10 | 37x25x50 | 5,0 | 500,19 |
| 49978-13 | 42x27,5x53 | 5,5 | 583,00 |

The parts coming into contact with food are in stainless steel. – Parti a contatto con il cibo in acciaio inox per alimenti.



Vertical manual sausage filler

Insaccatrice verticale
Wurstfüller
Poussoir manuel vertical
Ensacadora vertical

| art. | cm. | lt. | Kg. | € |
|----------|------------|-----|-----|--------|
| 49876-03 | 30x22x47,5 | 3 | 6,2 | 412,45 |

With 3 funnels. – Con 3 imbuti.



Manual slicing machine - Flywheel

Affettatrice manuale - Volano
Aufschnittmaschine - Schwungrad
Trancheuse manuelle - Volant
Cortadora manual - Volante

| art. | Ø cm. | cm. | Kg. | € |
|----------|-------|----------|-----|----------|
| 49971-25 | 25 | 68x52x51 | 33 | 5.031,63 |

Cut thickness range mm 0÷2,3. 9 cutting positions. Cut cm 18,5x51. – Spessore taglio mm. 0÷2,3. 8 scatti. Taglio utile cm 18,5x51.



Manual slicing machine - Flywheel

Affettatrice manuale - Volano
Aufschnittmaschine - Schwungrad
Trancheuse manuelle - Volant
Cortadora manual - Volante

| art. | Ø cm. | cm. | Kg. | € |
|----------|-------|----------|------|----------|
| 49972-30 | 30 | 72x60x74 | 45,5 | 5.472,23 |

Cut thickness range mm 0÷2,5. 9 cutting positions. Cut cm 23x19. – Spessore taglio mm. 0÷2,5. 9 scatti. Taglio utile cm 23x19.



Manual slicing machine - Flywheel

Affettatrice manuale - Volano
Aufschnittmaschine - Schwungrad
Trancheuse manuelle - Volant
Cortadora manual - Volante

| art. | Ø cm. | des. | € |
|----------|-------|-------|----------|
| 49971R25 | 25 | Rose | 5.336,45 |
| 49971M25 | 25 | Daisy | 5.336,45 |
| 49972R30 | 30 | Rose | 5.773,62 |
| 49972M30 | 30 | Daisy | 5.773,62 |



Stand

Piedistallo
Sockel
Piédestal
Pedestal

| art. | cm. | € |
|----------|-------|----------|
| 49971P25 | 65x80 | 1.874,83 |
| 49972P30 | 65x80 | 1.874,83 |



Stand with wheels

Piedistallo con ruote
Sockel mit Rädern
Piédestal avec roues
Pedestal con ruedas

| art. | cm. | € |
|----------|-------|----------|
| 49971R00 | 65x80 | 3.140,22 |



Block brush, plastic handle
Spazzola per ceppa
Blockbürste, Kunststoffgriff
Brosse à billot, matière plastique
Cepillo para cepa

| art. | cm. | € |
|----------|-----|-------|
| 42518-01 | 20 | 54,17 |



PE

Cutting board with tray
Tagliere con vasca
Tranchierbrett mit Tablett
Planche à découper avec plateau
Tabla de corte con bandeja

| art. | cm. | € |
|----------|-------------|-------|
| 44947-00 | 33,5x46x5,5 | 50,05 |



HDPE

Cutting board
Tagliere bar
Tranchierbrett
Planche à découper
Tabla de corte

| art. | cm. | € |
|----------|-------------|-------|
| 42521-16 | 16x24,5x1 | 6,13 |
| 42521-24 | 24,5x32,5x1 | 11,26 |



03 = RED / ROSSO
Raw meat and poultry
Carni crude
Rohes Fleisch
Viande crue
Carne cruda



02 = BROWN / MARRONE
Raw vegetables
Verdure crude
Rohes Gemüse
Crudités
Verduras crudas



04 = BLUE / BLU
Raw fish
Pesce
Fisch
Poisson
Pescado



01 = YELLOW / GIALLO
Cooked meats
Carni cotte
Gekochtes Fleisch
Viande cuite
Carne cocida



05 = GREEN / VERDE
Salads and fruits
Insalata e frutta
Salat und Früchte
Salade et fruits
Ensalada y fruta



00 = WHITE / BIANCO
Bakery and dairy products
Pane e formaggi
Brot und Käse
Pain et fromages
Pan y quesos



07 = VIOLA / VIOLET
Gluten Free
Casher
Hallal
Vegan



HDPE

Cutting board
Tagliere bar
Tranchierbrett
Planche à découper
Tabla de corte

| art. | cm. | GN | col. | € |
|----------|-----------|-----|------|-------|
| 42522-00 | 32x26,5x2 | 1/2 | ○ | 23,01 |
| 42522-01 | 32x26,5x2 | 1/2 | ● | 23,01 |
| 42522-02 | 32x26,5x2 | 1/2 | ● | 23,01 |
| 42522-03 | 32x26,5x2 | 1/2 | ● | 23,01 |
| 42522-04 | 32x26,5x2 | 1/2 | ● | 23,01 |
| 42522-05 | 32x26,5x2 | 1/2 | ● | 23,01 |
| 42522-09 | 32x26,5x2 | 1/2 | ● | 23,01 |



HDPE

Cutting board
Tagliere bar
Tranchierbrett
Planche à découper
Tabla de corte

| art. | cm. | GN | col. | € |
|----------|-----------|-----|------|-------|
| 42538-00 | 53x32,5x2 | 1/1 | ○ | 51,26 |
| 42538-01 | 53x32,5x2 | 1/1 | ● | 51,26 |
| 42538-02 | 53x32,5x2 | 1/1 | ● | 51,26 |
| 42538-03 | 53x32,5x2 | 1/1 | ● | 51,26 |
| 42538-04 | 53x32,5x2 | 1/1 | ● | 51,26 |
| 42538-05 | 53x32,5x2 | 1/1 | ● | 51,26 |
| 42538-09 | 53x32,5x2 | 1/1 | ● | 51,26 |



HDPE

Cutting board
Tagliere bar
Tranchierbrett
Planche à découper
Tabla de corte

| art. | cm. | col. | € |
|----------|---------|------|-------|
| 42539-00 | 60x40x2 | ○ | 63,11 |
| 42539-01 | 60x40x2 | ● | 68,54 |
| 42539-02 | 60x40x2 | ● | 68,54 |
| 42539-03 | 60x40x2 | ● | 68,54 |
| 42539-04 | 60x40x2 | ● | 68,54 |
| 42539-05 | 60x40x2 | ● | 68,54 |
| 42539-09 | 60x40x2 | ● | 68,54 |



HDPE

Cutting board
Tagliere bar
Tranchierbrett
Planche à découper
Tabla de corte

| art. | cm. | € |
|----------|-----------|-------|
| 42522-07 | 32x26,5x2 | 23,01 |
| 42538-07 | 53x32,5x2 | 51,26 |
| 42539-07 | 60x40x2 | 68,54 |



HDPE

Cutting board
Tagliere bar
Tranchierbrett
Planche à découper
Tabla de corte

| art. | cm. | € |
|----------|---------|-------|
| 42537-40 | 40x30x2 | 32,16 |
| 42537-50 | 50x30x2 | 39,80 |
| 42537-80 | 80x40x2 | 85,02 |



HDPE

Cutting board with groove
Tagliere con canalina
Tranchierbrett mit Kanal
Planche à découper avec rigole
Tabla de corte con ranura

| art. | cm. | GN | col. | € |
|----------|---------|-----|------|-------|
| 42546-00 | 65x53x2 | 2/1 | ○ | 83,01 |
| 42546-01 | 65x53x2 | 2/1 | ● | 83,01 |
| 42546-02 | 65x53x2 | 2/1 | ● | 83,01 |
| 42546-03 | 65x53x2 | 2/1 | ● | 83,01 |
| 42546-04 | 65x53x2 | 2/1 | ● | 83,01 |
| 42546-05 | 65x53x2 | 2/1 | ● | 83,01 |



HDPE

Cutting board with stoppers

Tagliere con fermi
Tranchierbrett mit Stiften
Planche à découper avec arrêts
Tabla de corte con barras de la parada

| art. | cm. | GN | col. | € |
|----------|-----------|-----|------|-------|
| 42543-00 | 53x32,5x2 | 1/1 | ○ | 60,10 |
| 42543-01 | 53x32,5x2 | 1/1 | ● | 60,10 |
| 42543-02 | 53x32,5x2 | 1/1 | ● | 60,10 |
| 42543-03 | 53x32,5x2 | 1/1 | ● | 60,10 |
| 42543-04 | 53x32,5x2 | 1/1 | ● | 60,10 |
| 42543-05 | 53x32,5x2 | 1/1 | ● | 60,10 |



HDPE

Cutting board with stoppers

Tagliere con fermi
Tranchierbrett mit Stiften
Planche à découper avec arrêts
Tabla de corte con barras de la parada

| art. | cm. | col. | € |
|----------|---------|------|-------|
| 42544-00 | 60x40x2 | ○ | 75,07 |
| 42544-01 | 60x40x2 | ● | 75,07 |
| 42544-02 | 60x40x2 | ● | 75,07 |
| 42544-03 | 60x40x2 | ● | 75,07 |
| 42544-04 | 60x40x2 | ● | 75,07 |
| 42544-05 | 60x40x2 | ● | 75,07 |



HDPE

Cutting board with stoppers

Tagliere con fermi
Tranchierbrett mit Stiften
Planche à découper avec arrêts
Tabla de corte con barras de la parada

| art. | cm. | € |
|----------|---------|-------|
| 42540-40 | 40x30x2 | 38,09 |
| 42540-50 | 50x30x2 | 45,83 |
| 42540-80 | 80x40x2 | 91,05 |



NEW



Allergen safety utensils set

Set utensili sicurezza allergeni
Allergensicherheits-Werkzeugset
Ensemble d'ustensiles (allergènes)
Juego utensilios de seguridad para alérgenos

| art. | cm. | Kg. | € |
|----------|----------|------|--------|
| 42528-00 | 58x41x10 | 4,76 | 291,45 |

Cutting board mm 305x457x13, chef's knife mm 254, s/s tongs and turner. – Tagliere mm 305x457x13, coltello cuoco mm 254, pinza e paletta inox.



HDPE

Colored cutting boards set 6 pcs

Taglieri colorati set 6 pz
Tranchierbretter 6 Stk.
Planches à découper set 6 pcs
Juego 6 tablas de corte

| art. | cm. | € |
|----------|-----------|--------|
| 42541-06 | 46x31x1,3 | 126,53 |



HDPE

Round cutting board

Tagliere tondo
Tranchierbrett, rund
Planche à découper, ronde
Tabla de corte redonda

| art. | Ø cm. | h. cm. | € |
|----------|-------|--------|-------|
| 42535-24 | 24,0 | 1,0 | 14,27 |
| 42535-32 | 32,5 | 1,5 | 25,43 |
| 42535-49 | 49,0 | 1,5 | 56,48 |



HDPE

Butchers table

Ceppa
Hackblock
Billot
Cepa

| art. | cm. | mm. | € |
|----------|----------|-----|--------|
| 42518-50 | 50x50x86 | 4* | 647,02 |

*Thickness. – Spessore.



HDPE

Worktop

Ceppo
Arbeitsplatte
Plan de travail
Encimera

| art. | cm. | mm. | € |
|----------|-------|-----|--------|
| 42519-01 | 50x50 | 4* | 148,44 |

*Thickness. – Spessore.



HDPE

Board scraper

Raschietto
Blockschäber
Racloir à planches
Rascador

| art. | cm. | € |
|----------|--------|-------|
| 42520-00 | 17x6x9 | 45,43 |

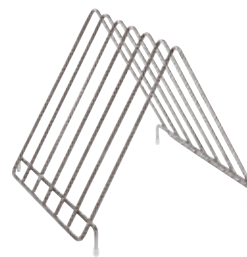

SS

Cutting board rack

Portataglieri in filo
Tranchierbretter-Träger
Sechoir à plaques à découper
Porta tablas

| art. | cm. | € |
|----------|------------|-------|
| 42542-00 | 30x26x27,5 | 49,45 |



W

Bread cutting board

Tagliere pane
Brotschneidbrett
Planche à découper
Tabla de corte

| art. | cm. | € |
|----------|-----------|-------|
| 42964-53 | 53x32,5x2 | 49,45 |
| 42964-60 | 60x40x2 | 57,99 |



CE

SS

Chainmail glove

Guanto in cotta di maglia
Fingerhandschuhe
Gant en cotte de mailles
Guante de malla

| art. | size/T. | col. | € |
|----------|---------|------|--------|
| 48505-01 | S | ○ | 168,74 |
| 48505-02 | M | ● | 168,74 |
| 48505-03 | L | ● | 168,74 |

UNI EN 1082-1:1998. Fits either hands, rings ø 4 mm. Thickness ø 0,5 mm. nylon strap.

Ambidestro, anelli ø 4 mm. Spessore ø 0,5 mm. cinturino nylon.



CE

SS

Chainmail glove, extended cuff

Guanto lungo in cotta di maglia
Fingerhandschuhe, lang
Gant en cotte de mailles, manchette longue
Guante largo de malla

| art. | size/T. | col. | € |
|----------|---------|------|--------|
| 48506-01 | S | ○ | 285,12 |
| 48506-02 | M | ● | 285,12 |
| 48506-03 | L | ● | 285,12 |

UNI EN 1082-1:1998. Fits either hands, rings ø 4 mm. Thickness ø 0,5 mm. nylon strap.

Ambidestro, anelli ø 4 mm. Spessore ø 0,5 mm. cinturino nylon.



CE

SS

Protective apron

Grembiule di protezione
Schutzschürze
Tablier de protection
Delantal de protección

| art. | cm. | € |
|----------|-------|--------|
| 48501-76 | 75x55 | 219,99 |

UNI EN 1082-1:1998. Belt fastening with textile adjustable and detachable straps. – Dotato di bretelle regolabili e staccabili.



Oven mitt

Guanto da forno
Ofenhandschuh
Moufle de déformement
Manopla de protección

| art. | l. cm. | € |
|----------|--------|------|
| 48510-00 | 28 | 4,52 |

Outer fabric 100% cotton with silver coating, 100 g/mq. – Tessuto esterno 100% cotone con rivestimento argenteo 100 g/mq.



Oven mitt, silicone

Guanto da forno, silicone
Backhandschuhe, Silikon
Gant de protection, silicone
Manopla de protección, silicona

| art. | € |
|----------|-------|
| 48514-00 | 63,32 |

Ambidextrous. Contact heat resistant up to +300°C for 15 seconds. Non-slip, water and oil tight, dishwasher safe. – Ambidestro. Resistenza al calore per contatto fino a 300°C per 15 secondi. Stagno all'acqua e agli oli bollenti, lavabile in lavastoviglie.



Cut resistant glove

Guanto antitaglio
Schnittschutz-Handschuh
Gant anti-coupures
Guante de protección

| art. | l. cm. | size/T. | € |
|----------|--------|---------|-------|
| 48523-01 | 22,0 | S | 38,79 |
| 48523-02 | 24,5 | M | 38,79 |
| 48523-03 | 27,0 | L | 38,79 |
| 48523-04 | 28,5 | XL | 38,79 |

HPPE yarn. Ambidextrous. Cut resistance Level 5. Suitable for contact with all types of food. Machine washable. – Filato HPPE. Guanti ambidestri. Resistenza al taglio Livello 5. Idonei al contatto con tutte le tipologie di alimenti. Lavabili in lavatrice.



NEW



Cut resistant glove

Guanto antitaglio
Schnittschutz-Handschuh
Gant anti-coupures
Guante de protección

| art. | size/T. | € |
|----------|---------|-------|
| 48524-01 | S | 69,95 |
| 48524-02 | M | 69,95 |
| 48524-03 | L | 69,95 |

With exclusive antimicrobial agent. 10 gauge Dyneema fiber. Ambidextrous lightweight. Machine washable. Protection level A7 ANSI.
Con esclusivo agente antimicrobico. Fibra Dyneema calibro 10. Ambidestri leggeri. Lavabili in lavatrice. Livello di protezione A7 ANSI.



NEW

Oven mitt CoolTouch Flame

Guanto da forno
Ofenhandschuh
Moufle de déformement
Manopla de protección

| art. | l. cm. | € |
|----------|--------|--------|
| 48507P38 | 38,1 | 123,01 |

Nomex, Kevlar seams. Heat and steam protection up to 280°C for 3 seconds. Ambidextrous. Machine washable. – Nomex, cuciture in Kevlar. Protezione dal calore e vapore fino a 280°C per 3 secondi. Ambidestro. Lavabile in lavatrice.



NEW

Oven mitt CoolTouch Flame

Guanto da forno
Ofenhandschuh
Moufle de déformement
Manopla de protección

| art. | l. cm. | € |
|----------|--------|--------|
| 48507-43 | 43,2 | 125,02 |

Nomex, Kevlar seams. Heat and steam protection up to 280°C for 3 seconds. Ambidextrous. Machine washable. – Nomex, cuciture in Kevlar. Protezione dal calore e vapore fino a 280°C per 3 secondi. Ambidestro. Lavabile in lavatrice.



NEW

Oven mitt CoolTouch

Guanto da forno
Ofenhandschuh
Moufle de déformement
Manopla de protección

| art. | l. cm. | € |
|----------|--------|-------|
| 48507-38 | 38,1 | 69,65 |

Polyester and cotton, Kevlar seams. Heat protection up to +260°C for 15 seconds. Ambidextrous. Machine washable. – Poliestere e cotone, cuciture in kevlar. Protezione dal calore fino a +260°C per 15 secondi. Ambidestro. Lavabile in lavatrice.



NEW

Oven mitt UltiGrips

Guanto da forno
Ofenhandschuh
Moufle de déformement
Manopla de protección

| art. | l. cm. | € |
|----------|--------|-------|
| 48508-43 | 43,2 | 66,93 |

Neoprene, Kevlar seams. Contact heat resistant up to +260°C for 15 seconds. Ambidextrous. Machine washable. – Neoprene, cuciture in Kevlar. Resistente al calore da contatto fino a +260°C per 15 secondi. Ambidestro. Lavabile in lavatrice.



NEW

Oven mitt BestGrips

Guanto da forno
Ofenhandschuh
Moufle de déformement
Manopla de protección

| art. | l. cm. | € |
|----------|--------|-------|
| 48509-43 | 43,2 | 53,37 |

Polyester and cotton. Non-slip neoprene gripp. Temperature protection from -23°C up to +260°C for 60 seconds. Ambidextrous. – Poliestere e cotone. Impugnatura antiscivolo in neoprene. Protezione termica da -23°C a +260°C per 60 secondi. Ambidestro.



NEW

Oven mitt BestGuard

Guanto da forno
Ofenhandschuh
Moufle de déformement
Manopla de protección

| art. | l. cm. | € |
|----------|--------|-------|
| 48509-33 | 33 | 22,71 |

Polyester and cotton, Kevlar seams. Non-stick coating. Heat protection up to +232°C for 30 seconds. Ambidextrous. – Poliestere e cotone, cuciture in kevlar. Rivestimento antiaderente. Protezione dal calore fino a +232°C per 30 secondi. Ambidestro.



NEW

Oven mitt BestGuard

Guanto da forno
Ofenhandschuh
Moufle de déformement
Manopla de protección

| art. | l. cm. | € |
|----------|--------|-------|
| 48509K43 | 43,2 | 30,15 |

Polyester and cotton, Kevlar seams. Non-stick coating. Heat protection up to +232°C for 30 seconds. Ambidextrous. – Poliestere e cotone, cuciture in kevlar. Rivestimento antiaderente. Protezione dal calore fino a +232°C per 30 secondi. Ambidestro.



Three-finger oven glove

Guanti anticalore a 3 dita
Backhandschuhe, 3 Finger
Moufles protection thermique, 3 doigts
Guantes de protección

| art. | l. cm. | € |
|----------|--------|-------|
| 48517-03 | 35,5 | 43,82 |

Resistant to abrasion, tears and cuts. CE marking, in accordance to the basic requirements concerning health and security of the European Directives 89/686/C.E.E. Contact heat resistant up to +350°C for 20 seconds. – Resistenti all'abrasione, agli strappi ed ai tagli. Marcati CE, rispettano i requisiti essenziali di salute e sicurezza secondo le direttive europee 89/686/C.E.E. Hanno una resistenza al calore per contatto fino a 350°C per 20 secondi.



Oven mitts

Guanti da forno
Backhandschuhe
Moufles de défournement
Manoplas de protección

| art. | cm. | € |
|----------|-------|-------|
| 48511-02 | 34x16 | 14,47 |

Special cotton fabric, natural color, reinforced palm and thumb. Heat resistant up to +200°C. Machine washable up to +40°C. – In cotone speciale, colore naturale, esecuzione rinforzata palmo e pollice. Resistente fino a +200°C. Lavabile in lavatrice max. 40°C.



Oven mitts

Guanti da forno
Backhandschuhe
Moufles de défournement
Manoplas de protección

| art. | cm. | € |
|----------|---------|-------|
| 48513-02 | 26x14,5 | 14,67 |

Special cotton fabric, natural color, reinforced palm and thumb. Heat resistant up to +200°C. Machine washable up to +40°C. – In cotone speciale, colore naturale, esecuzione rinforzata palmo e pollice. Resistente fino a +200°C. Lavabile in lavatrice max. 40°C.



Oven mitts

Guanti da forno
Backhandschuhe
Moufles de défournement
Manoplas de protección

| art. | cm. | € |
|----------|-------|-------|
| 48512-02 | 27x15 | 13,47 |

Special cotton fabric, natural color, reinforced palm and thumb. Heat resistant up to +200°C. Machine washable up to +40°C. – In cotone speciale, colore naturale, esecuzione rinforzata palmo e pollice. Resistente fino a +200°C. Lavabile in lavatrice max. 40°C.



Sugar gloves

Guanti in lattice
Zucker-Handschuhe
Gants à tirer le sucre
Guantes de látex

| art. | size/T. | € |
|----------|-----------|-------|
| 48516-07 | 7 – 7 1/2 | - |
| 48516-08 | 8 – 8 1/2 | 11,76 |
| 48516-09 | 9 – 9 1/2 | - |



Disposable nitrile glove

Guanto monouso in nitrile
Einweghandschuh aus Nitril
Gant nitrile jetable
Guante de nitrilo desechable

| art. | l. cm. | pcs/pz | size/T. | € |
|----------|--------|--------|---------|-------|
| 48519-01 | 24 | 100 | S | 15,38 |
| 48519-02 | 24 | 100 | M | 15,38 |
| 48519-03 | 24 | 100 | L | 15,38 |
| 48519-04 | 24 | 100 | XL | 15,38 |

Non-sterile, non-powder coated, with rolled edge. Textured on the fingertips. – Non sterili, senza rivestimento in polvere, con bordino arrotolato. Testurizzati sulla punta delle dita.



Scrubbing gloves

Guanti scrub
Schrubben Handschuhe
Gants à scrubbing
Guantes para fregar

| art. | size/T. | € |
|----------|----------|------|
| 48518-01 | one size | 9,55 |



Scrubbing gloves

Guanti scrub
Schrubben Handschuhe
Gants à scrubbing
Guantes para fregar

| art. | size/T. | € |
|----------|----------|------|
| 48518-02 | one size | 9,55 |



PASTRY PASTICCERIA

EQUIPMENT
ATTREZZATURE



PASTRY PASTICCERIA
STAINLESS STEEL CUTTERS TAGLIAPASTA INOX



Alphabet pcs 26

Alfabeto pz 26

| art. | Ø cm. | h. cm. | € |
|----------|-------|--------|-------|
| 47301-12 | 12 | 2 | 11,06 |



Numbers pcs 10

Numeri pz 10

| art. | Ø cm. | h. cm. | € |
|----------|-------|--------|------|
| 47302-10 | 10 | 2 | 5,03 |

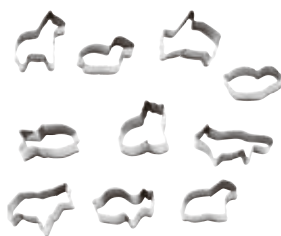

Animals pcs 10

Animali pz 10

| art. | Ø cm. | h. cm. | € |
|----------|-------|--------|------|
| 47303-10 | 10 | 2 | 5,73 |

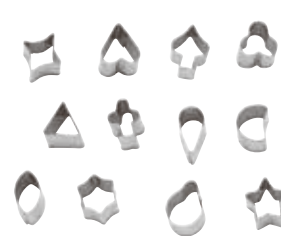

Shapes pcs 12

Sagome pz 12

| art. | Ø cm. | h. cm. | € |
|----------|-------|--------|------|
| 47304-06 | 6,5 | 2 | 5,03 |



Shapes pcs 12

Sagome pz 12

| art. | Ø cm. | h. cm. | € |
|----------|-------|--------|---|
| 47304-10 | 10 | 2 | - |



Shapes pcs 12

Sagome pz 12

| art. | Ø cm. | h. cm. | € |
|----------|-------|--------|------|
| 47304-12 | 12 | 2 | 6,63 |



Shapes pcs 12

Sagome pz 12

| art. | Ø cm. | h. cm. | € |
|----------|-------|--------|------|
| 47305-12 | 12 | 2 | 6,83 |



Flower pcs 6

Fiore pz 6

| art. | Ø cm. | h. cm. | € |
|----------|-------|--------|------|
| 47306-10 | 10 | 3 | 5,93 |



Trio pcs 6

Trio pz 6

| art. | Ø cm. | h. cm. | € |
|----------|-------|--------|------|
| 47307-10 | 10 | 3 | 5,73 |



Heart pcs 6

Cuore pz 6

| art. | Ø cm. | h. cm. | € |
|----------|-------|--------|------|
| 47308-10 | 10 | 3 | 5,43 |



Star pcs 6

Stella pz 6

| art. | Ø cm. | h. cm. | € |
|----------|-------|--------|------|
| 47310-10 | 10 | 3 | 5,63 |

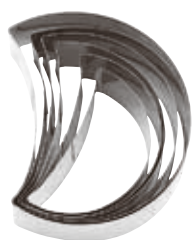

Halfmoon pcs 6

Mezzaluna pz 6

| art. | Ø cm. | h. cm. | € |
|----------|-------|--------|------|
| 47312-10 | 10 | 3 | 5,53 |

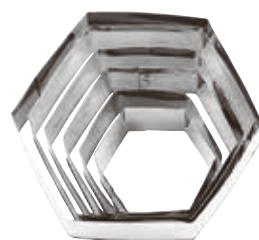

Hexagon pcs 6

Esagono pz 6

| art. | Ø cm. | h. cm. | € |
|----------|-------|--------|------|
| 47314-10 | 10 | 3 | 5,63 |

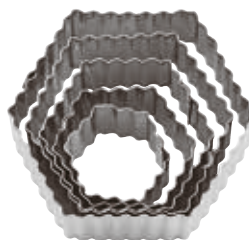

Hexagon, fluted pcs 5

Esagono festonato pz 5

| art. | Ø cm. | h. cm. | € |
|----------|-------|--------|------|
| 47315-10 | 10 | 3,5 | 5,23 |



Ring pcs 11

Anello pz 11

| art. | Ø cm. | h. cm. | € |
|----------|-------|--------|------|
| 47316-10 | 10 | 3 | 8,74 |



Ring pcs 14

Anello pz 14

| art. | Ø cm. | h. cm. | € |
|----------|-------|--------|-------|
| 47316-12 | 12 | 3 | 12,26 |



Ring pcs 20

Anello pz 20

| art. | Ø cm. | h. cm. | € |
|----------|-------|--------|-------|
| 47316-20 | 20 | 2,5 | 17,79 |



Ring, fluted pcs 11

Anello festonato pz 11

| art. | Ø cm. | h. cm. | € |
|----------|-------|--------|------|
| 47317-10 | 10 | 3 | 9,85 |



Ring, fluted pcs 14

Anello festonato pz 14

| art. | Ø cm. | h. cm. | € |
|----------|-------|--------|-------|
| 47317-12 | 12 | 3 | 12,26 |





Drop pcs 6
Goccia pz 6

| art. | Ø cm. | h. cm. | € |
|----------|-------|--------|------|
| 47321-12 | 12 | 3 | 5,03 |



Drop, fluted pcs 5
Goccia festonata pz 5

| art. | Ø cm. | h. cm. | € |
|----------|-------|--------|------|
| 47322-12 | 12,5 | 3,5 | 5,53 |



Square pcs 6
Quadro pz 6

| art. | Ø cm. | h. cm. | € |
|----------|-------|--------|------|
| 47323-12 | 12 | 3 | 4,92 |



Square, fluted pcs 6
Quadro festonato pz 6

| art. | Ø cm. | h. cm. | € |
|----------|-------|--------|------|
| 47324-12 | 12,5 | 3,5 | 5,73 |

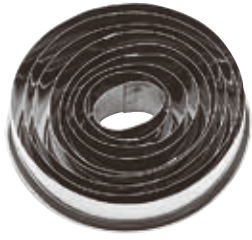

Oval pcs 9
Ovale pz 9

| art. | Ø cm. | h. cm. | € |
|----------|-------|--------|------|
| 47326-10 | 10 | 3,5 | 6,83 |

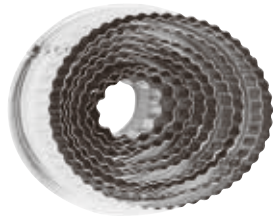

Oval, fluted pcs 9
Ovale festonato pz 9

| art. | Ø cm. | h. cm. | € |
|----------|-------|--------|------|
| 47325-10 | 10 | 3,5 | 9,85 |



Oval, fluted pcs 6
Ovale festonato pz 6

| art. | Ø cm. | h. cm. | € |
|----------|-------|--------|-------|
| 12947-13 | 13 | 3,5 | 19,10 |



Fruit pcs 12
Frutta pz 12

| art. | Ø cm. | h. cm. | € |
|----------|-------|--------|------|
| 47327-12 | 12,5 | 2 | 6,63 |



Animals pcs 10
Animali pz 10

| art. | Ø cm. | h. cm. | € |
|----------|-------|--------|------|
| 47328-15 | 15 | 2 | 7,34 |



Vehicles pcs 7
Veicoli pz 7

| art. | Ø cm. | h. cm. | € |
|----------|-------|--------|------|
| 47331-15 | 15 | 2 | 5,63 |



Vegetable pcs 12
Verdura pz 12

| art. | Ø cm. | h. cm. | € |
|----------|-------|--------|------|
| 47332-12 | 12,5 | 2 | 7,04 |



Christmas pcs 7
Natale pz 7

| art. | Ø cm. | h. cm. | € |
|----------|-------|--------|------|
| 47333-15 | 15 | 2 | 4,92 |



Easter pcs 6
Pasqua pz 6

| art. | Ø cm. | h. cm. | € |
|----------|-------|--------|------|
| 47334-12 | 12,5 | 2 | 4,22 |

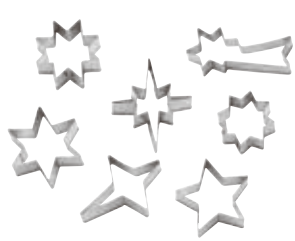

Stars pcs 7
Stelle pz 7

| art. | Ø cm. | h. cm. | € |
|----------|-------|--------|------|
| 47335-12 | 12,5 | 2 | 4,92 |



Shapes pcs 10
Sagome pz 10

| art. | Ø cm. | h. cm. | € |
|----------|-------|--------|------|
| 47419-10 | 15 | 2 | 6,63 |



Shapes pcs 42
Sagome pz 42

| art. | Ø cm. | € |
|----------|-------|-------|
| 47336-42 | 6>22 | 13,27 |



Plain ring pcs 3
Anello liscio pz 3

| art. | Ø cm. | h. cm. | € |
|----------|-------|--------|------|
| 47414-03 | 6-7-8 | 3 | 3,52 |



Fluted ring pcs 3
Anello festonato pz 3

| art. | Ø cm. | h. cm. | € |
|----------|-------|--------|------|
| 47415-03 | 6-7-8 | 3 | 3,52 |



Canestrello
Canestrello

| art. | Ø cm. | h. cm. | € |
|----------|-------|--------|------|
| 47416-06 | 6 | 3 | 1,41 |



Canestrello, fluted
Canestrello festonato

| art. | Ø cm. | h. cm. | € |
|----------|-------|--------|------|
| 47417-06 | 6 | 3 | 1,41 |

CHRISTMAS
NATALE



Gingerbread man
Omino pan di zenzero

| art. | cm. | € |
|----------|-------|------|
| 47370-08 | 6x8x3 | 0,80 |



Angel
Angelo

| art. | cm. | € |
|----------|-------|------|
| 47377-08 | 7x7x3 | 0,90 |



Snowman
Pupazzo di neve

| art. | cm. | € |
|----------|-------|------|
| 47378-08 | 4x8x3 | 0,70 |



Reindeer
Renna

| art. | cm. | € |
|----------|-------|------|
| 47379-08 | 8x7x3 | 0,80 |



Star
Stella

| art. | cm. | € |
|----------|-------|------|
| 47411-08 | 8x8x3 | 0,80 |

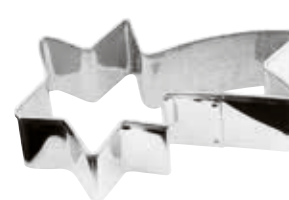

Comet
Stella cometa

| art. | cm. | € |
|----------|-------|------|
| 47412-08 | 8x4x3 | 0,70 |



Christmas tree
Albero di Natale

| art. | cm. | € |
|----------|-------|------|
| 47413-08 | 8x8x3 | 0,90 |



Pine
Pino

| art. | cm. | € |
|----------|---------|------|
| 47413-01 | 6,4x8x3 | 0,90 |



Snowflake
Fiocco di neve

| art. | cm. | € |
|----------|-----------|------|
| 47411-01 | 7,4x8,6x3 | 1,81 |



Snowflake
Fiocco di neve

| art. | cm. | € |
|----------|-------|------|
| 47411-02 | 7x8x3 | 0,90 |





Snowflake

Fiocco di neve

| art. | cm. | € |
|----------|---------|------|
| 47411-03 | 8,5x8x3 | 1,81 |



Christmas, set of 6 pcs.

Natale set 6 pz

| art. | cm. | € |
|----------|-------|------|
| 47387-01 | 8x8x3 | 7,44 |



**EASTER
PASQUA**



Rabbit

Coniglio

| art. | cm. | € |
|----------|-------|------|
| 47372-08 | 8x4x3 | 0,80 |



Rabbit

Coniglio

| art. | cm. | € |
|----------|-------|------|
| 47402-08 | 8x5x3 | 0,80 |



Rabbit

Coniglio

| art. | cm. | € |
|----------|---------|------|
| 47402-01 | 7x8,5x3 | 1,11 |



Rabbit

Coniglio

| art. | cm. | € |
|----------|---------|------|
| 47402-02 | 7,5x7x3 | 1,21 |



Bell

Campana

| art. | cm. | € |
|----------|-------|------|
| 47373-08 | 6x7x3 | 0,70 |



Lamb

Agnellino

| art. | cm. | € |
|----------|-------|------|
| 47376-08 | 8x7x3 | 0,90 |



Dove
Colomba

| art. | cm. | € |
|----------|-------|------|
| 47382-08 | 8x7x3 | 0,70 |



Egg
Uovo

| art. | cm. | € |
|----------|---------|------|
| 47373-01 | 5,6x8x3 | 1,31 |



Easter, set of 5 pcs.
Pasqua set 5 pz

| art. | cm. | € |
|----------|-------|------|
| 47387-02 | 8x8x3 | 6,33 |



HALLOWEEN



Skeleton
Scheletro

| art. | cm. | € |
|----------|-------|------|
| 47370-08 | 6x8x3 | 0,80 |



Pumpkin
Zucca

| art. | cm. | € |
|----------|-------|------|
| 47377-09 | 9x8x3 | 0,80 |



Pumpkin
Zucca

| art. | cm. | € |
|----------|-------|------|
| 47377-10 | 8x8x3 | 0,70 |



Ghost
Fantasma

| art. | cm. | € |
|----------|---------|------|
| 47377-03 | 8x8,4x3 | 0,90 |



Owl
Gufo

| art. | cm. | € |
|----------|-----------|------|
| 47377-02 | 4,7x8,3x3 | 0,80 |





Crescent
Mezzaluna

| art. | cm. | € |
|----------|---------|------|
| 47377-01 | 6,2x8x3 | 0,80 |



Witch
Strega

| art. | cm. | € |
|----------|---------|------|
| 47377-04 | 9x9,5x3 | 1,31 |



Witch hat
Cappello strega

| art. | cm. | € |
|----------|----------|------|
| 47377-05 | 8,5x13x3 | 1,01 |



Witch on broom
Strega su scopa

| art. | cm. | € |
|----------|-----------|------|
| 47377-06 | 11,6x12x3 | 1,61 |



Halloween, set of 3 pcs.
Halloween set 3 pz

| art. | cm. | € |
|----------|-----------|------|
| 47377-11 | 11x10,7x2 | 4,32 |



ANIMALS & VARIOUS
ANIMALI & VARI



Honey bee
Ape

| art. | cm. | € |
|----------|----------|------|
| 47382-06 | 11,6x8x3 | 1,51 |



Hippo
Ippopotamo

| art. | cm. | € |
|----------|--------|------|
| 47404-04 | 11x7x3 | 1,31 |



Butterfly
Farfalla

| art. | cm. | € |
|----------|-------|------|
| 47371-08 | 8x7x3 | 0,90 |





Snail
Lumaca

| art. | cm. | € |
|----------|--------|------|
| 47404-02 | 11x6x3 | 1,11 |



Fish
Pesce

| art. | cm. | € |
|----------|-------|------|
| 47384-08 | 8x8x3 | 0,90 |



Frog
Rana

| art. | cm. | € |
|----------|-------|------|
| 47380-08 | 8x8x3 | 0,80 |



Rooster
Gallo

| art. | cm. | € |
|----------|-------|------|
| 47383-08 | 8x8x3 | 1,21 |



Dolphin
Delfino

| art. | cm. | € |
|----------|-------|------|
| 47384-01 | 5x9x3 | 0,80 |



Seagull
Gabbiano

| art. | cm. | € |
|----------|--------|------|
| 47386-08 | 11x6x3 | 0,80 |



Cat
Gatto

| art. | cm. | € |
|----------|-------|------|
| 47401-08 | 8x8x3 | 0,80 |



Goose
Oca

| art. | cm. | € |
|----------|-------|------|
| 47404-08 | 8x7x3 | 0,80 |



Teddy bear
Orsetto

| art. | cm. | € |
|----------|-------|------|
| 47375-08 | 8x8x3 | 0,80 |



Camel
Cammello

| art. | cm. | € |
|----------|---------|------|
| 47404-01 | 9x8,6x3 | 1,31 |



Teddy bear
Orsetto

| art. | cm. | € |
|----------|-------|------|
| 47375-01 | 6x9x3 | 1,01 |



Elephant
Elefante

| art. | cm. | € |
|----------|--------|------|
| 47404-03 | 12x7x3 | 1,21 |



Four leaf clover
Quadrifoglio

| art. | cm. | € |
|----------|-------|------|
| 47374-08 | 8x8x3 | 0,80 |



Flower
Fiore

| art. | cm. | € |
|----------|---------|------|
| 47374-02 | 7x7,4x3 | 0,90 |



Tulip
Tulipano

| art. | cm. | € |
|----------|---------|------|
| 47374-01 | 5,5x8x3 | 1,21 |





Heart

Cuore

| art. | cm. | € |
|----------|-------|------|
| 47385-08 | 8x9x3 | 0,60 |



Two hearts

Due cuori

| art. | cm. | € |
|----------|---------|------|
| 47385-01 | 9,4x5x3 | 0,80 |



Rocking horse

Cavallo a dondolo

| art. | cm. | € |
|----------|-------|------|
| 47381-08 | 8x5x3 | 0,80 |



Bow

Fiocco

| art. | cm. | € |
|----------|-------|------|
| 47373-02 | 6x8x3 | 1,11 |



Apple

Mela

| art. | cm. | € |
|----------|-----------|------|
| 47378-01 | 7,6x8,4x3 | 1,11 |



Airplane

Aereo

| art. | cm. | € |
|----------|-------|------|
| 47370-02 | 9x8x3 | 1,11 |



Suits of cards, set of 4 pcs

Semi carte set 4 pz

| art. | cm. | € |
|----------|-----------|------|
| 47378-02 | 7,5x7,5x3 | 3,92 |



Numbers, set of 9 pcs

Numeri, set 9 pz

| art. | cm. | € |
|----------|---------|------|
| 47421-09 | 6,5x2,5 | 8,84 |

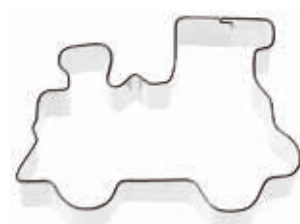

Train

Locomotiva

| art. | cm. | € |
|----------|--------|------|
| 47370-01 | 10x7x3 | 1,11 |



Pirate ship

Nave pirata

| art. | cm. | € |
|----------|---------|------|
| 47370-03 | 8x8,4x3 | 1,11 |



Letters, set of 26 pcs

Lettere, set 26 pz

| art. | cm. | € |
|----------|-------|-------|
| 47422-26 | 6x2,5 | 18,39 |





Round, set 6 pcs
Cerchio, set 6 pz

| art. | cm. | € |
|----------|-----|------|
| 47425-01 | 4x3 | 6,93 |
| 47425-02 | 5x3 | 7,24 |
| 47425-03 | 6x3 | 7,94 |



Square, set 6 pcs
Quadro, set 6 pz

| art. | cm. | € |
|----------|-------|-------|
| 47425-04 | 5x5x3 | 9,75 |
| 47425-05 | 6x6x3 | 11,36 |



Triangle, set 6 pcs
Triangolo, set 6 pz

| art. | cm. | € |
|----------|-----|------|
| 47425-06 | 6x3 | 8,34 |



Oval, set 6 pcs
Ovale, set 6 pz

| art. | cm. | € |
|----------|-----------|------|
| 47425-09 | 7,5x4,5x3 | 7,94 |



Trapeze, set 6 pcs
Trapezio, set 6 pz

| art. | cm. | € |
|----------|-------|------|
| 47425-08 | 9x6x3 | 8,64 |



Rectangle, set 6 pcs
Rettangolo, set 6 pz

| art. | cm. | € |
|----------|---------|------|
| 47425-10 | 5x3,5x3 | 8,34 |
| 47425-11 | 6x5x3 | 9,75 |



Drop, set 6 pcs
Goccia, set 6 pz

| art. | cm. | € |
|----------|-----|------|
| 47425-26 | 9x3 | 9,75 |



Hexagon, set 6 pcs
Esagono, set 6 pz

| art. | cm. | € |
|----------|-----|------|
| 47425-29 | 5x3 | 8,44 |
| 47425-30 | 6x3 | 9,45 |



Heart, set 6 pcs
Cuore, set 6 pz

| art. | cm. | € |
|----------|-------|------|
| 47425-32 | 6,5x3 | 8,84 |



Square, set 6 pcs
Quadro, set 6 pz

| art. | cm. | € |
|----------|---------|-------|
| 47426-01 | 8x8x4,5 | 15,08 |



Rectangle
Rettangolo

| art. | cm. | € |
|----------|----------|------|
| 47426-07 | 12x6x4,5 | 2,01 |



Doughnut cutter
Tagliapasta per doughnuts
Donut-Ausstecher
Coupe-donuts
Cortadonuts

| art. | Ø cm. | h. cm. | € |
|----------|-------|--------|-------|
| 47388-06 | 65-25 | 20 | 13,97 |
| 47388-07 | 70-30 | 17 | 14,77 |
| 47388-08 | 80-40 | 20 | 19,70 |



Cinnamon star cutter
Tagliapaste stelle
Zimtstern-Ausstecher
Coupe-étoiles
Cortapasta Esterella

| art. | cm. | € |
|----------|-------|-------|
| 47377-15 | 5x9,7 | 20,90 |

Spring mechanism. – Meccanismo a molla.



Horseshoe, tin plate
Ferro di cavallo, banda stagnata
Hufeisen, Weißblech
Fer à cheval, fer blanc
Herradura, hojalata

| art. | cm. | € |
|----------|-------|------|
| 47377-12 | 7x6x2 | 3,82 |





Oval fluted cutter

Tagliapasta ovale festonato

Ausstecher, oval, gewellt

Découpoir ovale cannelé

Cortapasta ovalado acanalado

| art. | Ø cm. | h. cm. | € |
|----------|---------|--------|------|
| 12947-02 | 5,5x3,5 | 3,5 | 2,21 |
| 12947-03 | 7x4 | 3,5 | 2,31 |
| 12947-04 | 8,5x5 | 3,5 | 3,02 |
| 12947-05 | 10x6 | 3,5 | 3,22 |
| 12947-06 | 11x7 | 3,5 | - |
| 12947-07 | 13x5 | 3,5 | 3,92 |



Dough plunger cutters w/extractor, 3 pcs

Tagliapasta con espulsore, set 3 pz

Ausstechformen mit Auswerfer, 3 Stk

Emportes-pièces, 3 pcs

Cortadores, 3 pz

| art. | Ø cm. | € |
|----------|-------|------|
| 47622-04 | 3x4,5 | 5,33 |

Holly. – Agrifoglio.



Dough plunger cutters w/extractor, 4 pcs

Tagliapasta con espulsore, set 4 pz

Ausstechformen mit Auswerfer, 4 Stk

Emportes-pièces, 4 pcs

Cortadores, 4 pz

| art. | Ø cm. | € |
|----------|---------------------|---|
| 47622-26 | 1,2 - 2 - 2,8 - 3,5 | - |

Daisy. – Margherita.



Dough plunger cutters w/extractor, 3 pcs

Tagliapasta con espulsore, set 3 pz

Ausstechformen mit Auswerfer, 3 Stk

Emportes-pièces, 3 pcs

Cortadores, 3 pz

| art. | Ø cm. | € |
|----------|-------|------|
| 47622-01 | 3x5 | 5,33 |

Petunie. – Petunia.



Dough plunger cutters w/extractor, 3 pcs

Tagliapasta con espulsore, set 3 pz

Ausstechformen mit Auswerfer, 3 Stk

Emportes-pièces, 3 pcs

Cortadores, 3 pz

| art. | Ø cm. | € |
|----------|-------|------|
| 47622-02 | 2,5 | 5,33 |

Flower. – Fiore.



Dough plunger cutters w/extractor, 3 pcs

Tagliapasta con espulsore, set 3 pz

Ausstechformen mit Auswerfer, 3 Stk

Emportes-pièces, 3 pcs

Cortadores, 3 pz

| art. | Ø cm. | € |
|----------|-------|------|
| 47622-03 | 3x5 | 5,33 |

Rose leaf. – Foglia di rosa.



Set of 9 cutters

Set 9 tagliapasta

Satz 9 Ausstechformen

Set 9 découpoirs

Juego 9 cortadores

| art. | h. cm. | € |
|----------|--------|---|
| 47837-09 | 0,5 | - |

SS



Almond past knife

Coltello per marzapane

Marzipan-Messer

Couteau à pâte d'amande

Cuchillo para fondant/mazapán

| art. | l. cm. | € |
|----------|--------|------|
| 47630-28 | 16,5 | 5,13 |

PA



Modelling tool set

Kit attrezzi decoro

Modellierungswerkzeugsatz

Set d'outils à pâte d'amandes

Juego de utensilios para modelar

| art. | l. cm. | pcs/pz | € |
|----------|--------|--------|-------|
| 47631-12 | 16 | 14 | 38,69 |

ABS



Modelling tool set

Kit attrezzi decoro

Modellierungswerkzeugsatz

Set d'outils à pâte d'amandes

Juego de utensilios para modelar

| art. | l. cm. | pcs/pz | € |
|----------|--------|--------|-------|
| 47631-08 | 16 | 12 | 19,90 |

ABS



Set of 10 pcs dipping forks

Set 10 forchettine praliniera

Pralinen Gabelchen, 10 Stk.

Jeu de 10 ébauchoirs

Set de 10 herramientas para decorar chocolates

| art. | € |
|----------|-------|
| 47833-10 | 42,71 |

SS



SS

Set of 4 pcs dipping forks

Set 4 forchettine pralineria

Pralinen Gabelchen, 4 Stk.

Jeu de 4 ébauchoirs

Set de 4 herramientas para decorar chocolates

| art. | € |
|----------|-------|
| 47833-04 | 21,21 |



SS

Set 2 decorating spoons

Set 2 cucchiari decorazione

Satz 2 Dekoration-Löffel

Set 2 cuillères pour décorer

2 cucharas para decoración

| art. | l. cm. | € |
|----------|--------|-------|
| 47831-02 | 18-20 | 10,15 |



**STAINLESS STEEL NOZZLES
BOCCHETTE INOX**



Set 12 pcs, one piece nozzles

Set 12 bocchette unipezzo

Tüllen Set 12 Stk. aus einem Stück gezogen

Set 12 pcs douilles monobloc

Surtido 12 boquillas monobloc

| art. | Ø mm. | base Ø mm. | € |
|----------|---|------------|-------|
| 47357-20 | 1x 0,6-1,2-1,5-1,9-2,4-3 3,6-4,8-5,6-6,4-6,8-7,6 | 18 | 11,96 |

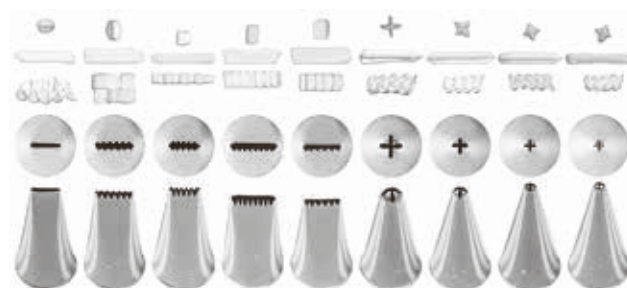

Set 9 pcs, one piece nozzles

Set 9 bocchette unipezzo

Tüllen Set 9 Stk. aus einem Stück gezogen

Set 9 pcs douilles monobloc

Surtido 9 boquillas monobloc

| art. | base Ø mm. | € |
|----------|------------|------|
| 47357-24 | 18 | 9,25 |



Set 7 pcs, one piece nozzles

Set 7 bocchette unipezzo

Tüllen Set 7 Stk. aus einem Stück gezogen

Set 7 pcs douilles monobloc

Surtido 7 boquillas monobloc

| art. | Ø mm. | base Ø mm. | € |
|----------|----------------------------|------------|------|
| 47357-21 | 1x 1,7-2,2-3,5-4,2-5-5,5-7 | 18 | 7,64 |



Set 8 pcs, one piece nozzles

Set 8 bocchette unipezzo

Tüllen Set 8 Stk. aus einem Stück gezogen

Set 8 pcs douilles monobloc

Surtido 8 boquillas monobloc

| art. | Ø mm. | base Ø mm. | € |
|----------|------------------------------|------------|------|
| 47357-22 | 1x 1-1,5-1,8-2,6-3-3,4-2,5-7 | 18 | 8,44 |



Set 8 pcs, one piece nozzles

Set 8 bocchette unipezzo
Tüllen Set 8 Stk. aus einem Stück gezogen
Set 8 pcs douilles monobloc
Surtido 8 boquillas monobloc

| art. | base ø mm. | € |
|----------|------------|------|
| 47357-28 | 18 | 8,94 |



Set 8 pcs, one piece nozzles

Set 8 bocchette unipezzo
Tüllen Set 8 Stk. aus einem Stück gezogen
Set 8 pcs douilles monobloc
Surtido 8 boquillas monobloc

| art. | base ø mm. | € |
|----------|------------|------|
| 47357-29 | 18 | 9,55 |



Set 8 pcs, one piece nozzles

Set 8 bocchette unipezzo
Tüllen Set 8 Stk. aus einem Stück gezogen
Set 8 pcs douilles monobloc
Surtido 8 boquillas monobloc

| art. | base ø mm. | € |
|----------|------------|------|
| 47357-30 | 18 | 9,55 |

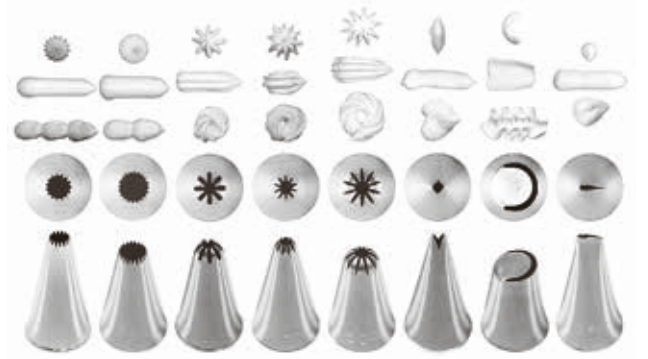

Set 8 pcs, one piece nozzles

Set 8 bocchette unipezzo
Tüllen Set 8 Stk. aus einem Stück gezogen
Set 8 pcs douilles monobloc
Surtido 8 boquillas monobloc

| art. | base ø mm. | € |
|----------|------------|------|
| 47357-31 | 18 | 8,44 |



Set 6 pcs, one piece nozzles

Set 6 bocchette unipezzo
Tüllen Set 6 Stk. aus einem Stück gezogen
Set 6 pcs douilles monobloc
Surtido 6 boquillas monobloc

| art. | base ø mm. | € |
|----------|------------|------|
| 47357-06 | 25 | 8,44 |



Set 6 pcs, one piece nozzles

Set 6 bocchette unipezzo
Tüllen Set 6 Stk. aus einem Stück gezogen
Set 6 pcs douilles monobloc
Surtido 6 boquillas monobloc

| art. | base ø mm. | € |
|----------|------------|------|
| 47357-07 | 25 | 8,44 |

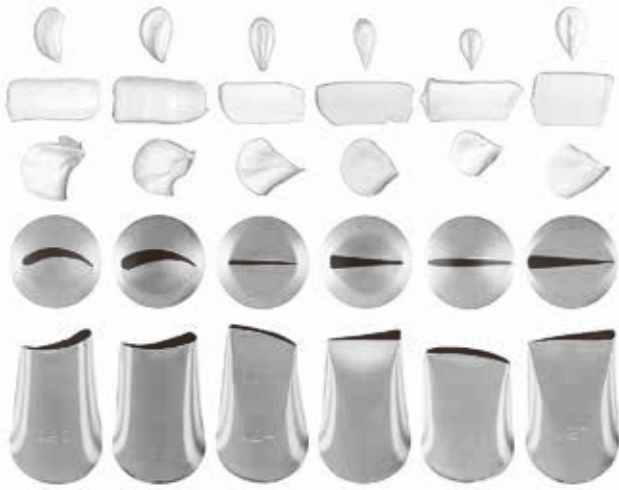

Set 6 pcs, one piece nozzles

Set 6 bocchette unipezzo
Tüllen Set 6 Stk. aus einem Stück gezogen
Set 6 pcs douilles monobloc
Surtido 6 boquillas monobloc

| art. | base ø mm. | € |
|----------|------------|------|
| 47357-08 | 25 | 8,44 |

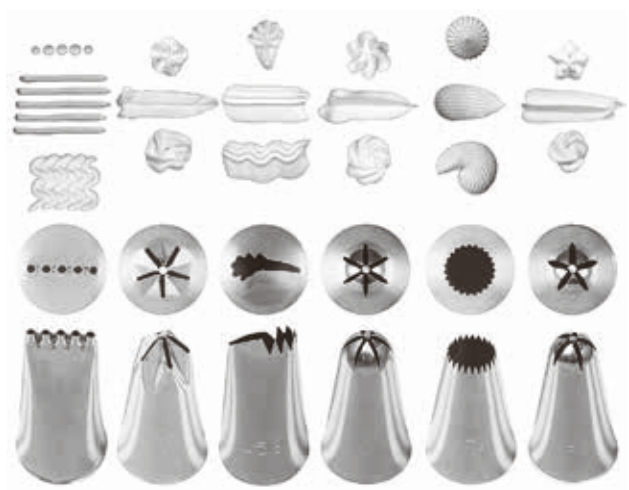

Set 6 pcs, one piece nozzles

Set 6 bocchette unipezzo
Tüllen Set 6 Stk. aus einem Stück gezogen
Set 6 pcs douilles monobloc
Surtido 6 boquillas monobloc

| art. | base ø mm. | € |
|----------|------------|------|
| 47357-09 | 25 | 8,74 |

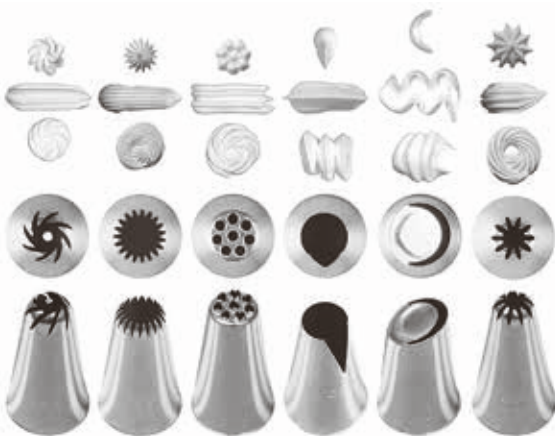

Set 6 pcs, one piece nozzles

Set 6 bocchette unipezzo
Tüllen Set 6 Stk. aus einem Stück gezogen
Set 6 pcs douilles monobloc
Surtido 6 boquillas monobloc

| art. | base ø mm. | € |
|----------|------------|------|
| 47357-10 | 25 | 8,44 |



Set 6 pcs, one piece nozzles

Set 6 bocchette unipezzo
Tüllen Set 6 Stk. aus einem Stück gezogen
Set 6 pcs douilles monobloc
Surtido 6 boquillas monobloc

| art. | base ø mm. | € |
|----------|------------|------|
| 47357-11 | 25 | 8,44 |



Set 4 pcs, one piece nozzles

Set 4 bocchette unipezzo
Tüllen Set 4 Stk. aus einem Stück gezogen
Set 4 pcs douilles monobloc
Surtido 4 boquillas monobloc

| art. | base ø mm. | € |
|----------|---------------|------|
| 47357-02 | 2x 31 - 2x 36 | 7,64 |



Set 7 pcs, one piece nozzles

Set 7 bocchette unipezzo
Tüllen Set 7 Stk. aus einem Stück gezogen
Set 7 pcs douilles monobloc
Surtido 7 boquillas monobloc

| art. | base ø mm. | € |
|----------|------------|-------|
| 47357-03 | 31 | 11,96 |





Set 3x2 nozzles

Set 3x2 bocchette

3x2 Stk. Tüllen

Set 3x2 pcs douilles

Juego 3x2 boquillas

| art. | Ø mm. | stars | € |
|----------|-------|-------|-------|
| 47350-01 | 2x 25 | 6 | 10,85 |
| | 2x 31 | 6 | |
| | 2x 36 | 6 | |



Set 3x2 nozzles

Set 3x2 bocchette

3x2 Stk. Tüllen

Set 3x2 pcs douilles

Juego 3x2 boquillas

| art. | Ø mm. | stars | € |
|----------|-------|-------|-------|
| 47351-01 | 2x 31 | 6 | 10,85 |
| | 2x 31 | 8 | |
| | 2x 36 | 9 | |



Set 3x2 nozzles

Set 3x2 bocchette

3x2 Stk. Tüllen

Set 3x2 pcs douilles

Juego 3x2 boquillas

| art. | Ø mm. | stars | € |
|----------|-------|-------|-------|
| 47352-01 | 2x 31 | 6 | 10,85 |
| | 2x 31 | 8 | |
| | 2x 36 | 9 | |



Set 6 pcs, one piece nozzles

Set 6 bocchette unipezzo

Tüllen Set 6 Stk. aus einem Stück gezogen

Set 6 pcs douilles monobloc

Surtido 6 boquillas monobloc

| art. | Ø mm. | stars | € |
|----------|-------|-------|-------|
| 47208-01 | 3,0 | 5 | 10,65 |
| 47208-02 | 3,0 | 6 | 10,65 |
| 47208-03 | 3,5 | 7 | 10,65 |
| 47208-04 | 5,0 | 8 | 10,65 |



Set 6 pcs, one piece nozzles

Set 6 bocchette unipezzo

Tüllen Set 6 Stk. aus einem Stück gezogen

Set 6 pcs douilles monobloc

Surtido 6 boquillas monobloc

| art. | Ø mm. | stars | € |
|----------|-------|-------|-------|
| 47208-05 | 5 | 5 | 10,65 |
| 47208-06 | 5 | 6 | 10,65 |
| 47208-07 | 6 | 7 | 10,65 |
| 47208-08 | 7 | 8 | 10,65 |



Set 6 pcs, one piece nozzles

Set 6 bocchette unipezzo

Tüllen Set 6 Stk. aus einem Stück gezogen

Set 6 pcs douilles monobloc

Surtido 6 boquillas monobloc

| art. | Ø mm. | stars | € |
|----------|-------|-------|-------|
| 47208-09 | 7 | 5 | 10,65 |
| 47208-10 | 7 | 6 | 10,65 |
| 47208-11 | 7 | 7 | 10,65 |
| 47208-12 | 9 | 8 | 10,65 |



Set 6 pcs, one piece nozzles

Set 6 bocchette unipezzo

Tüllen Set 6 Stk. aus einem Stück gezogen

Set 6 pcs douilles monobloc

Surtido 6 boquillas monobloc

| art. | Ø mm. | stars | € |
|----------|-------|-------|-------|
| 47208-13 | 11 | 5 | 10,65 |
| 47208-14 | 11 | 6 | 10,65 |
| 47208-15 | 11 | 7 | 10,65 |
| 47208-16 | 11 | 8 | 10,65 |



Set 6 pcs, one piece nozzles

Set 6 bocchette unipezzo

Tüllen Set 6 Stk. aus einem Stück gezogen

Set 6 pcs douilles monobloc

Surtido 6 boquillas monobloc

| art. | Ø mm. | stars | € |
|----------|-------|-------|-------|
| 47208-17 | 13 | 5 | 10,95 |
| 47208-18 | 13 | 6 | 10,95 |
| 47208-19 | 13 | 7 | 10,95 |
| 47208-20 | 13 | 8 | 10,95 |



Set 6 pcs, one piece nozzles

Set 6 bocchette unipezzo

Tüllen Set 6 Stk. aus einem Stück gezogen

Set 6 pcs douilles monobloc

Surtido 6 boquillas monobloc

| art. | Ø mm. | stars | € |
|----------|-------|-------|-------|
| 47208-21 | 18 | 5 | 10,95 |
| 47208-22 | 18 | 6 | 10,95 |
| 47208-23 | 18 | 7 | 10,95 |
| 47208-24 | 18 | 8 | 10,95 |



Set 6 pcs, one piece nozzles

Set 6 bocchette unipezzo

Tüllen Set 6 Stk. aus einem Stück gezogen

Set 6 pcs douilles monobloc

Surtido 6 boquillas monobloc

| art. | Ø mm. | stars | € |
|----------|-------|-------|-------|
| 47354-02 | 2 | 6 | 10,55 |
| 47354-04 | 4 | 6 | 10,55 |
| 47354-06 | 6 | 6 | 10,55 |
| 47354-08 | 8 | 6 | 10,55 |
| 47354-10 | 10 | 6 | 10,55 |
| 47354-12 | 12 | 7 | 10,55 |
| 47354-14 | 14 | 8 | 10,55 |
| 47354-16 | 16 | 9 | 10,55 |
| 47354-18 | 18 | 10 | 10,55 |



Set 6 pcs, one piece nozzles

Set 6 bocchette unipezzo

Tüllen Set 6 Stk. aus einem Stück gezogen

Set 6 pcs douilles monobloc

Surtido 6 boquillas monobloc

| art. | Ø mm. | stars | € |
|----------|-------|-------|-------|
| 47355-02 | 2,5 | 6 | 10,55 |
| 47355-04 | 4,0 | 6 | 10,55 |
| 47355-06 | 6,0 | 6 | 10,55 |
| 47355-08 | 8,0 | 7 | 10,55 |
| 47355-10 | 10 | 8 | 10,55 |
| 47355-12 | 12 | 10 | 10,55 |



Set 6 pcs, one piece nozzles

Set 6 bocchette unipezzo

Tüllen Set 6 Stk. aus einem Stück gezogen

Set 6 pcs douilles monobloc

Surtido 6 boquillas monobloc

| art. | Ø mm. | stars | € |
|----------|-------|-------|-------|
| 47356-02 | 2,0 | 5 | 10,55 |
| 47356-04 | 4,0 | 9 | 10,55 |
| 47356-06 | 5,5 | 9 | 10,55 |
| 47356-08 | 7,0 | 10 | 10,55 |
| 47356-10 | 8,5 | 12 | 10,55 |
| 47356-12 | 13,0 | 15 | 10,55 |
| 47356-14 | 14,5 | 16 | 10,55 |
| 47356-16 | 16,0 | 17 | 10,55 |
| 47356-18 | 17,5 | 18 | 10,55 |



Set 6 pcs, one piece nozzles

Set 6 bocchette unipezzo

Tüllen Set 6 Stk. aus einem Stück gezogen

Set 6 pcs douilles monobloc

Surtido 6 boquillas monobloc

| art. | Ø mm. | € |
|----------|-------|-------|
| 47353-02 | 2 | 10,55 |
| 47353-04 | 4 | 10,55 |
| 47353-06 | 6 | 10,55 |
| 47353-08 | 8 | 10,55 |
| 47353-10 | 10 | 10,55 |
| 47353-12 | 12 | 10,55 |
| 47353-14 | 14 | 10,55 |
| 47353-16 | 16 | 10,55 |
| 47353-18 | 18 | 10,55 |
| 47353-20 | 20 | 10,55 |
| 47353-22 | 22 | 10,55 |
| 47353-24 | 24 | 10,55 |



Set 6 pcs, one piece nozzles

Set 6 bocchette unipezzo

Tüllen Set 6 Stk. aus einem Stück gezogen

Set 6 pcs douilles monobloc

Surtido 6 boquillas monobloc

| art. | Ø mm. | € |
|----------|-------|-------|
| 47207-20 | 20 | 10,95 |
| 47207-25 | 25 | 10,95 |
| 47207-30 | 30 | 10,95 |



Set 10 pcs Bismark nozzles

Set 10 bocchette a imbuto

Fülltüllen Set 10 Stk.

Set 10 douilles à choux

Surtido 10 boquillas para relleno

| art. | Ø mm. | l. mm. | € |
|----------|-------|--------|-------|
| 47127-04 | 4 | 90 | 30,15 |
| 47127-06 | 6 | 75 | 28,04 |
| 47127-08 | 8 | 90 | 32,96 |





Nozzle
Bocchetta decorativa
Spritztülle
Douille
Boquilla

| art. | Ø mm. | h. cm. | € |
|----------|-------|--------|-------|
| 47357-50 | 55 | 6 | 13,57 |



Nozzle
Bocchetta decorativa
Spritztülle
Douille
Boquilla

| art. | Ø mm. | h. cm. | € |
|----------|-------|--------|-------|
| 47357-51 | 55 | 5,6 | 13,57 |



Nozzle
Bocchetta decorativa
Spritztülle
Douille
Boquilla

| art. | Ø mm. | h. cm. | € |
|----------|-------|--------|------|
| 47357-40 | 32 | 6,0 | 8,04 |



Nozzle
Bocchetta decorativa
Spritztülle
Douille
Boquilla

| art. | Ø mm. | h. cm. | € |
|----------|-------|--------|------|
| 47357-41 | 32 | 5,7 | 8,04 |



Nozzle
Bocchetta decorativa
Spritztülle
Douille
Boquilla

| art. | Ø mm. | h. cm. | € |
|----------|-------|--------|------|
| 47357-42 | 32 | 5,7 | 8,04 |



Nozzle
Bocchetta decorativa
Spritztülle
Douille
Boquilla

| art. | Ø mm. | h. cm. | € |
|----------|-------|--------|------|
| 47357-43 | 32 | 5,7 | 8,04 |



Nozzle
Bocchetta decorativa
Spritztülle
Douille
Boquilla

| art. | Ø mm. | h. cm. | € |
|----------|-------|--------|------|
| 47357-44 | 32 | 5,7 | 8,04 |



Set of 6 nozzles
Set 6 bocchette
Tüllen Set, 6 Stk
Set 6 douilles
Juego 6 boquillas

| art. | Ø mm. | € |
|----------|----------------|------|
| 47214-86 | 5-7-9-11-13-15 | 7,84 |



Set of 6 nozzles
Set 6 bocchette
Tüllen Set, 6 Stk
Set 6 douilles
Juego 6 boquillas

| art. | Ø mm. | € |
|----------|---------------|------|
| 47215-86 | 3-5-7-9-11-13 | 7,84 |



Set of 12 nozzles
Set 12 bocchette
Tüllen Set, 12 Stk
Set 12 douilles
Juego 12 boquillas

| art. | Ø mm. | € |
|----------|-------|-------|
| 47618-10 | 2>10 | 20,30 |
| 47618-20 | 10>20 | 20,30 |



Set of 12 nozzles
Set 12 bocchette
Tüllen Set, 12 Stk
Set 12 douilles
Juego 12 boquillas

| art. | € |
|----------|-------|
| 47250-12 | 55,58 |

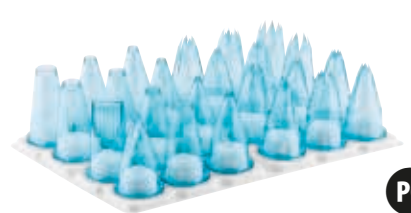

Set of 24 nozzles
Set 24 bocchette
Tüllen Set, 24 Stk
Set 24 douilles
Juego 24 boquillas

| art. | € |
|----------|-------|
| 47250-24 | 80,30 |



Flower nozzles 12 pcs

Bocchette floreali 12 pz
Spritztüllen 12 Stk
Douille fleurs 12 pcs
Boquillas florales 12 pz

| art. | € |
|----------|-------|
| 47357-38 | 37,19 |



Set of 29 nozzles

Set 29 bocchette
Tüllen Set, 29 Stk
Set 29 douilles
Juego 29 boquillas

| art. | € |
|----------|-------|
| 47219-29 | 31,56 |

26 tubes, 2 flower nails, 1 standard coupler. – 26
bocchette, 2 chiodi per fiori, 1 adattatore standard.



Set of 38 nozzles

Set 38 bocchette
Tüllen Set, 38 Stk
Set 38 douilles
Juego 38 boquillas

| art. | € |
|----------|-------|
| 47219-38 | 84,82 |

35 tubes, 1 medium coupler, 1 large coupler. – 35
bocchette, 1 adattatore medio, 1 grande.



Set of 55 nozzles

Set 55 bocchette
Tüllen Set, 55 Stk
Set 55 douilles
Juego 55 boquillas

| art. | € |
|----------|-------|
| 47219-55 | 62,51 |

52 tubes, 2 flower nails, 1 standard coupler. – 52
bocchette, 2 chiodi per fiori, 1 adattatore standard.



External piping tip adapter

Adattatore per bocchette
Adapter für Spritztüllen
Adaptateur à douilles
Adaptador para boquillas

| art. | Ø mm. | des. | € |
|----------|-------|----------|------|
| 47212-01 | 18 | STANDARD | 1,11 |



External piping tip adapter

Adattatore per bocchette
Adapter für Spritztüllen
Adaptateur à douilles
Adaptador para boquillas

| art. | Ø mm. | des. | € |
|----------|-------|--------|------|
| 47212-02 | 25-31 | MEDIUM | 2,21 |



External piping tip adapter

Adattatore per bocchette
Adapter für Spritztüllen
Adaptateur à douilles
Adaptador para boquillas

| art. | Ø mm. | des. | € |
|----------|-------|-------|------|
| 47212-03 | 36 | LARGE | 2,01 |





Nozzles adapter, 2 pcs

Adattatori per bocchette, 2 pz
Spritztüllen-Adapter, 2 Stk
Adaptateurs à douilles, 2 pièces
Adaptadores boquillas, 2 piezas

| art. | € |
|----------|-------|
| 47212-05 | 27,24 |

**To prepare decorations with 2 or 3 colours.
Suitable for piping tips base Ø 30 h 50 mm.**
Per decorazioni a 2 o 3 colori. Adatte a bocchette base Ø 30 h 50 mm.



Pastry tube brush, 6 pcs

Bruschino per bocchette, 6 pz
Tüllen-Bürste, 6 Stk
Brosse à douilles, 6 pcs
Cepillo para boquillas, 6 pz

| art. | Ø cm. | l. cm. | € |
|----------|---------|--------|------|
| 47200-01 | 0,8 | 10 | 7,54 |
| 47200-02 | 0,5-2,4 | 12,5 | 9,55 |



Cream roll molds, 10 pcs

Cannoli, 10 pz
Sahnerolle, konisch/gerade, 10 Stk
Rouleau à fromage, 10 pcs
Rodillos queso, 10 pz

| art. | Ø mm. | l. mm. | € |
|----------|-------|--------|-------|
| 47020-15 | 15 | 92 | 26,63 |
| 47020-20 | 22 | 142 | 35,88 |
| 47020-30 | 10-25 | 139 | 37,79 |
| 47020-35 | 20-25 | 171 | 43,01 |



Cream horn molds, 10 pcs

Cornetti, 10 pz
Schillerlockenform, 10 Stk
Moulet à cornet, 10 pcs
Moldes para conos, 10 pz

| art. | Ø mm. | l. mm. | € |
|----------|-------|--------|-------|
| 47021-35 | 34 | 110 | 30,45 |
| 47021-45 | 47 | 161 | 43,92 |



Icing bag

Sacchetto per decorare
Spritzbeutel
Sac à dresser
Mangas para decorar

| art. | h. cm. | U. Pack | € |
|----------|--------|---------|------|
| 47106-28 | 28 | 6 | 4,82 |
| 47106-34 | 34 | 6 | 5,33 |
| 47106-40 | 40 | 6 | 6,13 |
| 47106-46 | 46 | 6 | 6,93 |
| 47106-50 | 50 | 6 | 7,74 |

Synthetic fibre with multi-layer water-proof plastic coating.



Icing bag

Sacchetto per decorare
Spritzbeutel
Sac à dresser
Mangas para decorar

| art. | h. cm. | U. Pack | € |
|----------|--------|---------|-------|
| 47106-55 | 55 | 6 | 8,04 |
| 47106-60 | 60 | 6 | 9,15 |
| 47106-65 | 65 | 6 | 10,55 |
| 47106-70 | 70 | 6 | 12,26 |
| 47106-75 | 75 | 6 | 13,07 |

Fibra sintetica con rivestimento a strati in plastica impermeabile.



Icing bag

Sacchetto per decorare
Spritzbeutel
Sac à dresser
Mangas para decorar

| art. | h. cm. | U. Pack | € |
|----------|--------|---------|------|
| 47105-28 | 28 | 6 | 5,13 |
| 47105-34 | 34 | 6 | 5,83 |
| 47105-40 | 40 | 6 | 6,43 |
| 47105-46 | 46 | 6 | 7,34 |
| 47105-50 | 50 | 6 | 8,14 |

Polyurethane coated cotton fabric. Waterproof, suitable for all mixtures. With top seam, hanger and reinforced tip.



Icing bag

Sacchetto per decorare
Spritzbeutel
Sac à dresser
Mangas para decorar

| art. | h. cm. | U. Pack | € |
|----------|--------|---------|-------|
| 47105-55 | 55 | 6 | 9,35 |
| 47105-60 | 60 | 6 | 10,05 |
| 47105-65 | 65 | 6 | 12,56 |
| 47105-70 | 70 | 6 | 13,97 |
| 47105-75 | 75 | 6 | 15,88 |

Tessuto di cotone rivestito in poliuretano. Impermeabile, adatto a tutte le miscele. Con orlo superiore, gancio e punta rinforzata.



PE

Double pastry bag

Sacchetto per decorare doppio
Doppeldressierbeutel
Sac à dresser, double
Mangas para decorar, doble

| art. | my | cm. | pcs/pz | € |
|----------|----|-----------|--------|-------|
| 47104-45 | 70 | 45,5x30,5 | 75 | 45,23 |

Disposable. For 2 ingredients. Closed tip, can be used without tube.

Monouso. Per 2 ingredienti. Punta chiusa, può essere utilizzato senza bocchette.



Icing bag, polyurethane

Sacchetto per decorare, poliuretano
Spritzbeutel, Polyurethan
Sac à dresser, polyuréthane
Mangas para decorar, poliuretano

| art. | h. cm. | € |
|----------|--------|-------|
| 47112-34 | 34 | 15,98 |
| 47112-45 | 45 | 18,19 |
| 47112-50 | 50 | 19,90 |



GRIP EFFECT

PE

Disposable icing bag

Sacchetto per decorare, monouso
Einwegspritzbeutel
Sac à dresser jetable
Mangas desechables

| art. | my | h. cm. | pcs/pz | € |
|----------|----|--------|--------|-------|
| 47118-30 | 80 | 30 | 100 | 20,10 |
| 47118-40 | 80 | 40 | 100 | 24,72 |
| 47118-55 | 80 | 55 | 100 | 34,77 |
| 47118-65 | 80 | 65 | 100 | 42,71 |



SUPER RESISTANT

PE

Disposable icing bag

Sacchetto per decorare, monouso
Einwegspritzbeutel
Sac à dresser jetable
Mangas desechables

| art. | my | h. cm. | pcs/pz | € |
|----------|----|--------|--------|-------|
| 47111-30 | 80 | 30 | 100 | 16,68 |
| 47111-40 | 80 | 40 | 100 | 21,91 |
| 47111-46 | 80 | 46 | 100 | 29,65 |
| 47111-55 | 80 | 55 | 100 | 38,09 |



SS

Cookie press set

Siringa per pasticceria
Gebäckpresse
Seringue à biscuits
Juego pistola repostería

| art. | ml. | € |
|----------|-----|---|
| 47010-20 | 250 | - |

For a correct use of the syringe we suggest shortbread dough. – Per un utilizzo ottimale della siringa suggeriamo la frolla montata.



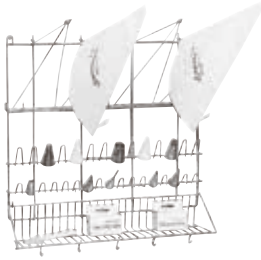

SS

Icing bags & nozzles wall rack

Espositore sacchetti/bocchette
Spritzbeutel-/ u. Tüllenaufhänger
Séchoir à poche et douilles
Secador mangas y boquillas

| art. | dim. cm. | € |
|----------|----------|-------|
| 47113-03 | 50x42x50 | 87,03 |



SS

Wall rack for icing bags

Espositore per sacchetti
Spritzbeutelaufränger
Séchoir à poche
Secador cuelga-mangas

| art. | dim. cm. | € |
|----------|----------|-------|
| 47107-00 | 50x42x26 | 37,89 |

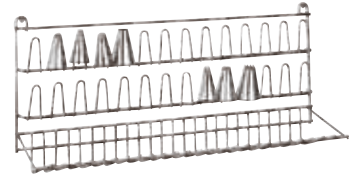

SS

Wall rack for nozzles

Espositore per bocchette
Tüllenaufhänger
Séchoir à douilles
Secador boquillas

| art. | dim. cm. | € |
|----------|----------|-------|
| 47108-00 | 50x13x24 | 47,54 |



PP

Icing bag holder

Vaso porta sacchetto
Spritzbeutel-Absetzständer
Support à poches
Soporte para mangas

| art. | Ø cm. | h. cm. | € |
|----------|-------|--------|-------|
| 47110-23 | 19,5 | 23 | 11,66 |



Cake plate, swivel base, aluminum

Girello, alluminio
Tortendrehscheibe, aluminium
Guéridon plaque tournante, alu
Pedestal giratorio para tartas, aluminio

| art. | dim. cm. | € |
|----------|----------|---|
| 47101-40 | 30x40x10 | - |



MF

Cake-plate, swivel base

Girello per decorazione torte
Tortendrehscheibe
Guéridon plaque tournante
Pedestal giratorio para tartas

| art. | Ø cm. | h. cm. | € |
|----------|-------|--------|-------|
| 47103-32 | 32 | 10 | 43,32 |



PE

Protection cover

Campana
Abdeckhauben
Cloche
Tapa

| art. | Ø cm. | h. cm. | € |
|----------|-------|--------|-------|
| 47103-30 | 30 | 12 | 20,50 |



SS

Cake peel

Pala per torte
Tortenschaufel
Pelle à tarte
Pala para tartas

| art. | Ø cm. | dim. cm. | € |
|----------|-------|----------|-------|
| 47094-30 | 30 | 27x26 | 25,63 |



Doilies

Pizzi sottotorta
Tortenspitzen, Rosendekor
Dentelles décor rose
Blondas

| art. | dim. cm. | pcs/pz | € |
|----------|----------|--------|------|
| 47687-24 | 18-25 | 250 | 8,54 |



Doilies

Pizzi sottotorta
Tortenspitzen, Rosendekor
Dentelles décor rose
Blondas

| art. | dim. cm. | pcs/pz | € |
|----------|----------|--------|-------|
| 47686-10 | 6-10 | 250 | 4,22 |
| 47686-12 | 6,5-12 | 250 | 6,53 |
| 47686-14 | 8-14 | 250 | 6,93 |
| 47686-17 | 9,5-16,5 | 250 | 10,45 |
| 47686-22 | 12,5-22 | 100 | 5,73 |
| 47686-24 | 15-24 | 100 | 5,23 |



Doilies

Pizzi sottotorta
Tortenspitzen, Rosendekor
Dentelles décor rose
Blondas

| art. | dim. cm. | pcs/pz | € |
|----------|----------|--------|-------|
| 47686-26 | 16-27 | 100 | 5,93 |
| 47686-30 | 19-30 | 100 | 6,83 |
| 47686-33 | 20-32 | 100 | 8,44 |
| 47686-36 | 32-36 | 100 | 10,15 |
| 47686-42 | 25-42 | 100 | 12,56 |



SS

Draining rack

Griglia di colaggio
Überziehgitter
Grille à glacer
Rejilla

| art. | dim. cm. | € |
|----------|----------|-------|
| 44430-60 | 60x40 | 18,59 |

**Frame ø mm 5, 2 cross-bars, 29 wires ø 2 mm.
Quadro ø mm 5, 2 traverse, 29 fili ø 2 mm.**

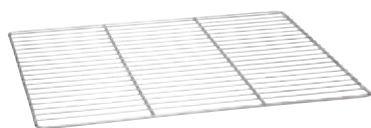

SS

Draining rack
Griglia di colaggio
Überziehgitter
Grille à glacer
Rejilla

| art. | dim. cm. | € |
|----------|----------|-------|
| 44430-61 | 60x40 | 26,33 |

Frame ø mm 6, 2 cross-bars, 24 wires ø 3 mm.
Quadro ø mm 6, 2traverse, 24 fili ø 3 mm.



SS

Draining rack
Griglia di colaggio
Überziehgitter
Grille à glacer
Rejilla

| art. | dim. cm. | € |
|----------|-------------|-------|
| 44431-46 | 46x30,5x2,5 | 11,86 |
| 44431-60 | 60x40x2,5 | 20,40 |

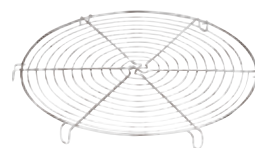

Cake cooling tray, chromed
Griglia di raffreddamento, cromata
Tortengitter, verchromt
Grille ronde à tourte, chromé
Rejilla para tortas, cromada

| art. | Ø cm. | € |
|----------|-------|------|
| 47098-18 | 18,5 | 3,72 |
| 47098-22 | 22,0 | 4,62 |
| 47098-26 | 26,0 | 5,23 |
| 47098-30 | 30,0 | 6,23 |



Baking tray, aluminum
Teglia, alluminio
Backblech, Aluminium
Plaque à cuisson, aluminium
Placa pastelería, aluminio

| art. | GN | dim. cm. | € |
|----------|-----|-----------|-------|
| 41744-32 | 1/1 | 32,5x53x1 | 20,40 |
| 41744-53 | 2/1 | 53x65x1 | 55,48 |
| 41744-60 | - | 60x40x1 | 28,84 |

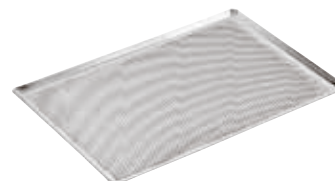

Baking tray perforated, aluminum
Teglia forata, alluminio
Backblech, Aluminium, gelocht
Plaque perforée, aluminium
Placa pastelería perforada, aluminio

| art. | GN | dim. cm. | € |
|----------|-----|-----------|-------|
| 41756-30 | - | 30x40x1 | 22,11 |
| 41756-32 | 1/1 | 32,5x53x1 | 26,93 |
| 41756-53 | 2/1 | 53x65x1 | 51,76 |
| 41756-60 | - | 60x40x1 | 44,72 |



Baking tray, alusteel
Teglia rettangolare, alluminata
Backblech mit Aluminiumüberzug
Plaque, tôle aluminitée
Placa pastelería, aluminizada

| art. | dim. cm. | € |
|----------|----------|-------|
| 41746-60 | 60x40x2 | 18,39 |



Baking tray, alusteel
Teglia rettangolare, alluminata
Backblech mit Aluminiumüberzug
Plaque, tôle aluminitée
Placa pastelería, aluminizada

| art. | dim. cm. | € |
|----------|----------|-------|
| 41751-30 | 30x23x3 | 13,77 |
| 41751-35 | 35x28x3 | 13,77 |
| 41751-40 | 40x30x3 | 16,08 |
| 41751-50 | 50x35x3 | 18,39 |
| 41751-60 | 60x40x3 | 21,51 |
| 41751-65 | 65x45x3 | 25,73 |



Baking tray, non stick coated
Teglia rettangolare, antiaderente
Backblech mit Antihafbeschichtung
Plaque revêtement anti-adhésif
Placa pastelería anti-adherente

| art. | dim. cm. | € |
|----------|----------|-------|
| 41747-60 | 60x40x2 | 57,79 |





Baking tray, aluminum, silicone coated

Teglia, alluminio siliconato
Alu-Backblech, Silikonbeschichtet
Plaque alu, revêtement silicone
Placa aluminio siliconada

| art. | GN | dim. cm. | € |
|----------|-----|----------|-------|
| 41743D32 | 1/1 | 53x32,5 | 32,16 |
| 41743D53 | 2/1 | 53x65 | 55,48 |
| 41743D60 | - | 40x60 | 45,43 |

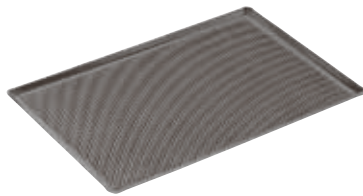

Baking tray, perforated aluminum, silicone coated

Teglia, alluminio siliconato, forato
Alu-Backblech, gelocht, Silikonbeschichtet
Plaque alu perforée, revêtement silicone
Placa aluminio perforada siliconada

| art. | GN | dim. cm. | € |
|----------|-----|----------|-------|
| 41753D30 | - | 30x40 | 25,93 |
| 41753D32 | 1/1 | 53x32,5 | 35,88 |
| 41753D53 | 2/1 | 53x65 | 56,58 |
| 41753D60 | - | 40x60 | 39,90 |



Bread mold, blue steel

Bacinella carré, ferro blu
Brotform, Blaublech
Pain de mie, tôle bleuie
Molde, hierro

| art. | dim. cm. | € |
|----------|----------|-------|
| 41748-20 | 20x10x10 | 29,95 |
| 41748-30 | 30x10x10 | 31,36 |
| 41748-35 | 35x10x10 | 32,46 |
| 41748-40 | 40x10x10 | 33,67 |
| 41748-50 | 50x10x10 | 36,28 |



Bread mold, alusteel

Bacinella carré, alluminata
Brotform mit Aluminiumüberzug
Pain de mie, tôle aluminitée
Molde, acero aluminizado

| art. | dim. cm. | € |
|----------|----------|-------|
| 41750-20 | 20x10x10 | 28,94 |
| 41750-30 | 30x10x10 | 30,55 |
| 41750-40 | 40x10x10 | 35,68 |
| 41750-41 | 40x15x15 | 51,56 |
| 41750-50 | 50x10x10 | 38,19 |



Confectionery funnel

Imbuto colatore
Likör- u. Fondanttrichter
Entonnoir à confiserie
Embudo de confitería

| art. | Ø cm. | h. cm. | lt. | € |
|----------|-------|--------|-----|--------|
| 47800-22 | 21 | 31,5 | 2 | 193,36 |

Supplied with 3 nozzles ø 4, 5, 6 mm.
Con 3 bocchette ø 4, 5, 6 mm.



Confectionery funnel

Imbuto colatore
Likör- u. Fondanttrichter
Entonnoir à fondant
Embudo colador

| art. | Ø cm. | h. cm. | lt. | € |
|----------|-------|--------|-----|-------|
| 47801-20 | 14 | 20 | 0,9 | 58,69 |

Supplied with 3 nozzles ø 4, 6, 7,5 mm.
Con 3 bocchette ø 4, 6, 7,5 mm.



Cream dispenser

Dosa creme
Dosierer
Doseur à crème
Dosificador

| art. | dim. cm. | € |
|----------|----------|--------|
| 47612-01 | 20x16x23 | 365,52 |



Cream injector

Dosatrice per creme
Gebäkfüllmaschine
Entonnoir à crème
Dosificador de porciones

| art. | dim. cm. | lt. | € |
|----------|----------|-----|----------|
| 47694-03 | 25x44x20 | 3 | 1.368,11 |

Body in polished aluminum. Funnel, cylinder, piston, injector, lever and thrust rib in s/s. Piston: ø 24 mm. Doses: 1-12 gr. Incl. 3 injectors ø 5, 6 and 7 mm. – Corpo in alluminio brillantato. Imbuto, cilindro, pistone, iniettore, leva e nasello di spinta inox. Pistone ø 24 mm. Dosi 1-12 gr. Incl. 3 iniettori ø 5, 6 e 7 mm.



Electric caramelizing rod

Caramellizzatore elettrico
Caramelaiser-Eisen, elektrisch
Fer à caraméliser électrique
Quemador eléctrico

| art. | Ø cm. | kW | € |
|----------|-------|------|--------|
| 47847-10 | 10 | 0,65 | 266,53 |
| 47847-12 | 12 | 1,00 | - |



Electric caramelising rod

Caramellizzatore elettrico
Caramelisier-Eisen, elektrisch
Fer à caraméliser électrique
Quemador eléctrico

| art. | l. cm. | kW | € |
|----------|--------|-----|--------|
| 47847-23 | 23 | 1,5 | 200,20 |



SS

Sugar lamp

Lampada per zucchero
Zuckerlampe
Lampe à sucre
Lámpara para azúcar

| art. | dim. cm. | € |
|----------|----------|--------|
| 47840-11 | 61x41x50 | 631,54 |

Infrared lamp, 3 selection powers 500-1000-1500W. Cable included. – Lampada infrarossi con 3 potenze selezionabili, 500-1000-1500W. Incl. cavo di alimentazione.



Electric spray gun

Pistola elettrica
Sprühpistole, elektrisch
Pistolet électrique
Pistola eléctrica

| art. | ml. | W | € |
|----------|-----|----|--------|
| 47848-07 | 700 | 60 | 676,26 |

Bar 0-160, rpm 250 - For butter, oil, fat, wax, jelly, jam, chocolate, releasing agents and emulsions. Usable for hot liquids max. 65 °C. Nozzle 0,6 mm. – Per burro, oli, cera, gelatina, marmellata, cioccolata, antiagglomeranti ed emulsionanti. Per liquidi caldi max. 65°C. Bocchetta 0,6 mm.



Airbrush compressor

Compressore per penna aerografa
Airbrush Kompressor
Compresseur
Compresor

| art. | dim. cm. | bar | kW | € |
|----------|----------|-----|-----|--------|
| 47844-06 | 16x30x23 | 4 | 0,2 | 392,55 |

Power 1/5 HP. Air output per min./litres: 23-25. Voltage: 220-240V/50HZ. Max. pressure 6,5 bar/95PSI. – Potenza 1/5 HP. Volume aria min. 23-25L. Voltaggio 220-240V/50HZ. Pressione Massima 6,5 bar/95PSI.



Airbrush, double action

Penna aerografa, doppia azione
Airbrush-Pistole, Doppelaktion
Aérographe, dual action
Equipo aerógrafo, doble acción

| art. | Ø mm. | cap. | € |
|----------|-------|------|--------|
| 47844-02 | 0,3 | 7 cc | 176,68 |



Airbrush stand

Supporto penna aerografa
Airbrush-Pistole Gestell
Support aérographe
Soporte aerógrafo

| art. | € |
|----------|---|
| 47844-01 | - |



ABS

Tempering unit

Temperatrice
Temperiergerät
Tempereuse
Templadora

| art. | Ø cm. | h. cm. | lt. | € |
|----------|-------|--------|-----|--------|
| 47698-01 | 20,5 | 21,2 | 1,7 | 572,25 |

Ideal for chocolate coatings of ice creams on sticks. Removable anodized aluminum tank. Ideale per coperture in cioccolato di gelati su stecco. Vasca estraibile in alluminio anodizzato.



ABS

Tempering unit

Temperatrice
Temperiergerät
Tempereuse
Templadora

| art. | Ø cm. | h. cm. | lt. | € |
|----------|-------|--------|-----|--------|
| 47698-02 | 26 | 16 | 1,8 | 314,06 |

Mini dry melter, allows to process tiny chocolate quantities. Practical removable tank. Mini scioglitore a secco, adatto per piccole produzioni. Pratica vasca estraibile.





SS
ABS

Tempering unit

Temperatrice
Temperiergerät
Tempereuse
Templadora

| art. | dim. cm. | lt. | € |
|----------|------------|-----|--------|
| 47698-03 | 40x24x13,5 | 3,6 | 639,78 |
| 47698-06 | 40x33x13,5 | 6,0 | 761,49 |

Analog tempering units. Different wirings upon request. – Temperatrici analogiche. Su richiesta cablaggio: GB/USA/GIAPPONE/AUSTRALIA/CINA.



ABS
SS

Tempering unit, digital

Temperatrice digitale
Temperiergerät, digital
Tempereuse digitale
Templadora digital

| art. | dim. cm. | lt. | € |
|----------|------------|-----|----------|
| 47698-07 | 40x33x13,5 | 6,0 | 1.045,00 |

With thermal probe. Tempering manually adjustable or following the 3 programs: white, milk and dark chocolate.

Con sonda termica. Temperaggio regolabile manualmente o seguendo i 3 programmi per cioccolato bianco, al latte e fondente.



Chef's torch

Cannello professionale
Profi-Wärmepistole
Chalumeau de cuisine
Soplete cocina

| art. | dim. cm. | ml. | € |
|----------|----------|-----|-------|
| 47841-03 | 8x7x16 | 200 | 39,50 |



Chef's torch

Cannello professionale
Profi-Wärmepistole
Chalumeau de cuisine
Soplete cocina

| art. | dim. cm. | ml. | € |
|----------|----------|-----|-------|
| 47841-04 | 12x7x18 | 280 | 83,42 |



Sugar bulb

Pompeta con terminale in rame
Blaszuckerspritze
Poire à sucre soufflé
Pera para azúcar soplado

| art. | € |
|----------|-------|
| 47838-00 | 40,00 |



Sugar/jam thermometer

Termometro per zucchero/marmellata
Zucker- und Marmeladenthermometer
Thermomètre à sucre et confiture
Termómetro azúcar y mermelada

| art. | scala | °C | € |
|----------|-------|-----------|-------|
| 47843-05 | 2°C | +40+200°C | 34,07 |

Brass. – Ottone. Dim. 4,7x20 cm.



SS

Sugar thermometer

Termometro per zucchero
Zuckerthermometer
Thermomètre à sucre
Termometro para azúcar

| art. | scala | °C | € |
|----------|-------|---------|-------|
| 47843-00 | 1°C | +80+200 | 40,70 |



SS

Sugar thermometer holder

Reggi caramellometro
Zuckerthermometer-Träger
Support pour thermomètre à sucre
Soporte para termometro azúcar

| art. | h. cm. | € |
|----------|--------|-------|
| 47842-00 | 32 | 80,90 |



Syrup density meter test tube

Provetta alimentare graduata, plastica
Sirup-Hydrometer-Becher
Eprouvette pèse-sirop
Probeta aerómetro

| art. | Ø cm. | h. cm. | ml. | € |
|----------|-------|--------|-----|-------|
| 49703-01 | 3 | 25 | 100 | 21,41 |

Can be sterilized up to 120°C.
Sterilizzabile fino a 120°C.



Syrup density meter

Pesa sciroppo (densimetro)
Sirup-Hydrometer
Pèse-sirop
Aerómetro

| art. | l. cm. | € |
|----------|--------|-------|
| 49703-00 | 12,5 | 17,19 |

**Temp.: 20°C - gr./ml.°Bé: 1.100/1.400/15-40 -
Div.: 0,010 g/ml/2°Bé**



PA+
plus

Angular spatula

Spatola angolare
Winkelpalette
Spatule angulaire
Espátula angular

| art. | l. cm. | € |
|----------|--------|------|
| 12909-12 | 12 | 4,72 |
| 12909-23 | 23 | 5,03 |



ABS

Smoother

Paletta per lisciare
Teig-Glätter
Lisse-pâte

Espátula para alisar

| art. | dim. cm. | € |
|----------|----------|---|
| 47627-01 | 15x8 | - |



Biscuit spatula

Spatola per biscuit
Biscuit-Spachtel
Spatule à biscuit
Espátula para biscuit

| art. | l. cm. | € |
|----------|--------|-------|
| 47626-55 | 55,5 | 19,60 |



Ruler

Riga
Lineal
Règle
Regla

| art. | l. cm. | € |
|----------|--------|------|
| 47033-50 | 60 | 9,55 |

**5 divisions cm 12 and 7 divisions cm 8.
5 divisioni 12 cm e 7 da 8 cm.**



Cake slicer

Lira per pan di Spagna
Tortendrahtschneider
Lyre à genoise
Cortador de pasteles

| art. | Ø cm. | h. cm. | € |
|----------|-------|--------|---|
| 47031-44 | 30 | 20>60 | - |



Cake slicer, 3 cutting wires

Lira per pan di Spagna, 3 fili
Tortendrahtschneider, 3 Drähte
Lyre à genoise, 3 lames
Cortador de pasteles 3 alambres

| art. | Ø cm. | h. cm. | € |
|----------|-------|--------|--------|
| 47031-46 | 46 | 10>90 | 141,40 |



PE

Ganache frame set

Set telaio per ganache
Ganache Rahmenset
Ensemble cadres à ganache
Conjunto de marcos para ganache

| art. | cm. int. | € |
|----------|----------|--------|
| 47693-00 | 24x24 | 412,15 |

**Base, 2 frames H 5 mm, 2 frames H 3 mm.
Base, 2 telai H 5 mm, 2 telai H 3 mm.**





SS

Single frame
Telaio singolo
Rahmen
Cadre
Marco

| art. | cm. ext. | cm. int. | h. mm. | € |
|----------|----------|----------|--------|--------|
| 47693-03 | 38x38 | 36x36 | 3 | 78,59 |
| 47693-05 | 38x38 | 36x36 | 5 | 86,33 |
| 47693-10 | 37x37 | 36x36 | 10 | 102,81 |
| 47693-15 | 37x37 | 36x36 | 15 | 117,69 |

To produce perfect layers. – Per creare stratificazioni precise.



PE

ABS

SS

Mini guitar
Chitarra mini
Pralinenschneider Mini
Mini-guitare
Mini guitarra

| art. | dim. cm. | € |
|----------|--------------|----------|
| 47692-03 | 44,5x33,5x14 | 1.177,66 |

Cutting frame 22 mm., s/s plate, plastic spatula, 3 spare wires, 2 spanners. Do not use for frozen pies, chocolate bars or generally hard paste. Cutting place 25x28 cm. – Telaio di taglio 22 mm., piatto inox, spatola plastica, 3 fili di ricambio, 2 chiavi. Non usare per torte congelate, tavolette di cioccolato, impasti duri in genere. Piano di taglio 25x28 cm.



SS

Guitar
Chitarra
Pralinenschneider
Guitare simple
Guitarra

| art. | dim. cm. | Cut/Taglio | Kg. | € |
|----------|-------------|------------|-----|----------|
| 47692-11 | 53x45x16 mm | 360x420 | 16 | 2.053,42 |

Construction in PE, PS and s/steel frames. Includes s/s plate, spatula, 3 spare threads, 2 fixing keys, 3 frames 22,5-30-45 mm. – Costruzione in PE, PS e telai inox. Incl piatto inox, racla, 3 fili ricambio, 2 chiavi di fissaggio, 3 telai da 22,5-30-45 mm.



SS

Double guitar
Chitarra doppia
Pralinenschneider, doppelt
Guitare double
Guitarra doble corte

| art. | dim. cm. | Cut/Taglio | Kg. | € |
|----------|-------------|------------|------|----------|
| 47692-22 | 50x48x15 mm | 360x350 | 19,6 | 2.681,84 |

Construction in aluminum, PS and s/steel frames. Includes s/s plate, spatula, 3 spare threads, 2 fixing keys, 3 frames 22,5-30-45 mm. – Costruzione in alluminio, PS e telai inox. Incl piatto inox, racla, 3 fili ricambio, 2 chiavi di fissaggio, 3 telai da 22,5-30-45 mm.

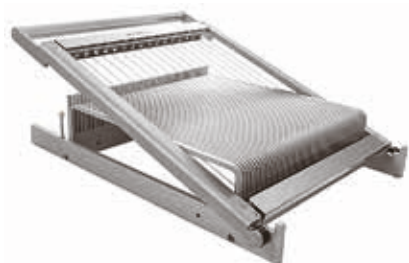

SS

Guitar
Chitarra
Pralinenschneider
Guitare simple
Guitarra

| art. | dim. cm. | Cut/Taglio | Kg. | € |
|----------|-------------|------------|-----|----------|
| 47692-25 | 60x40x11 mm | 380x400 | 24 | 3.343,94 |

Construction in aluminum, s/steel frames. Includes s/s plate, spatula, maintenance kit, 3 frames 22,5-30-45 mm. – Costruzione in alluminio, telai inox. Incl piatto inox, racla, kit assistenza, 3 telai da 22,5-30-45 mm.





SS

Expanding pastry cutter

Tagliapasta estensibile
Teigschneider
Rouleau extensible
Cortapastas extensible

| art. | Ø cm. | l. cm. | wheels | € |
|----------|-------|--------|--------|-------|
| 47820-05 | 5,5 | 24 | 5 | 72,36 |
| 47820-07 | 5,5 | 24 | 7 | 98,39 |

Plain wheels. – Rotelle lisce.



SS

Expanding pastry cutter

Tagliapasta estensibile
Teigschneider
Rouleau extensible
Cortapastas extensible

| art. | Ø cm. | l. cm. | wheels | € |
|----------|-------|--------|--------|--------|
| 47821-05 | 5,5 | 24 | 5 | 74,67 |
| 47821-07 | 5,5 | 24 | 7 | 101,71 |

Fluted wheels. – Rotelle ondulate.



SS

Expanding pastry cutter

Tagliapasta estensibile
Teigschneider
Rouleau extensible
Cortapastas extensible

| art. | Ø cm. | l. cm. | wheels | € |
|----------|-------|--------|--------|--------|
| 47822-05 | 5,5 | 28 | 5x2 | 93,87 |
| 47822-07 | 5,5 | 28 | 7x2 | 126,63 |

Plain wheels. – Rotelle lisce.



SS

Pastry wheel, plain

Rotella taglia pasta liscia
Teigrädchen, glatt
Roulette à pâte lisse
Ruleta cortapasta

| art. | Ø cm. | l. cm. | € |
|----------|-------|--------|------|
| 18325-01 | 5,5 | 18 | 8,04 |



SS

Pastry wheel, fluted

Rotella taglia pasta ondulata
Teigrädchen, gewellt
Roulette à pâte cannelée
Ruleta cortapasta acanalada

| art. | Ø cm. | l. cm. | € |
|----------|-------|--------|------|
| 18325-02 | 5,5 | 18 | 7,74 |



SS

Double pastry wheel

Rotella taglia pasta lama doppia
Teigrädchen, glatt u. gewellt
Roulette à pâte double
Ruleta cortapasta doble

| art. | Ø cm. | l. cm. | € |
|----------|-------|--------|-------|
| 18325-03 | 5,5 | 18 | 10,15 |



Cutting roller, POM

Rullo tagliapasta, POM
Rollmesser, POM
Rouleau à lamelles, POM
Rodillo, POM

| art. | cm. | € |
|----------|-----|------|
| 47026-06 | 6 | 7,24 |



Spiked roller, POM

Rullo bucafoglia, POM
Stipprolle, POM
Pique-pâte, POM
Rodillo, POM

| art. | cm. | € |
|----------|------|------|
| 47024-06 | 6,0 | 6,63 |
| 47024-10 | 11,5 | 7,84 |



Cutting roller, POM

Rullo per losanghe, POM
Rollmesser, POM
Rouleau à losanges, POM
Rodillo a rombos, POM

| art. | cm. | € |
|----------|------|-------|
| 47025-06 | 6,0 | 7,04 |
| 47025-10 | 11,5 | 10,05 |



SS

Spiked roller

Rullo bucafoglia
Stipprolle
Pique-pâte
Rodillo

| art. | cm. | € |
|----------|-----|-------|
| 47028-12 | 12 | 73,16 |



SS

Cutting roller

Rullo per losanghe
Rollmesser
Rouleau à losanges
Rodillo a rombos

| art. | cm. | € |
|----------|-----|-------|
| 47029-12 | 12 | 75,27 |



PP

SS

Croissant cutter

Taglia croissants
Dreieckschneidwalze
Coupe-croissants
Cortador para croissants

| art. | dim. cm. | € |
|----------|----------|--------|
| 47027-11 | 18x20 | 106,83 |
| 47027-12 | 18x14 | 108,84 |
| 47027-14 | 9,7x21 | 95,88 |
| 47027-15 | 18x20 2x | 144,52 |
| 47027-16 | 18x20 3x | 232,36 |



PS

Stencil for grating pastry
Stampo decora crostate
Gitterstempel
Empreinte pour grille de pâte
Molde tortas

| art. | Ø cm. | € |
|----------|-------|-------|
| 47030-30 | 30 | 19,30 |



PP

Cake marker
Segnaporzioni
Tortenteiler
Diviseur à tarte
Marcador de tartas

| art. | Ø cm. | por. | € |
|----------|-------|------|------|
| 47032-10 | 26,5 | 10 | 6,83 |
| 47032-20 | 26,5 | 20 | 6,83 |



PP

Cake marker, double-sided
Segnaporzioni, doppio
Tortenteiler, doppelseitig
Diviseur à tarte, double
Marcador de tartas, doble

| art. | Ø cm. | por. | € |
|----------|-------|-------|------|
| 47033-08 | 18 | 8-12 | 7,14 |
| 47033-12 | 26,5 | 12-18 | 7,14 |
| 47033-14 | 26,5 | 14-18 | 7,14 |



Rolling pin, non-stick coated
Rullo antiaderente
Rollwalze mit Antihafbeschichtung
Rouleau avec revêtement anti-adhésif
Rodillo amasador anti-adherente

| art. | Ø cm. | l. cm. | € |
|----------|-------|--------|-------|
| 47035-40 | 5,5 | 20 | 43,22 |
| 47035-48 | 6,5 | 25 | 54,87 |



W

Rolling pin
Rullo
Rollwalze
Rouleau
Rodillo amasador

| art. | Ø cm. | l. cm. | € |
|----------|-------|--------|--------|
| 47036-30 | 9 | 30 | 62,51 |
| 47036-35 | 9 | 35 | 65,63 |
| 47036-40 | 9 | 40 | 68,94 |
| 47036-45 | 9 | 45 | 81,00 |
| 47036-50 | 9 | 50 | 146,33 |
| 47036-60 | 9 | 60 | 157,58 |



W

Rolling pin
Rullo
Rollwalze
Rouleau
Rodillo amasador

| art. | Ø cm. | l. cm. | € |
|----------|-------|--------|-------|
| 47038-50 | 9 | 50 | 81,30 |
| 47038-60 | 7 | 60 | 73,26 |



PE

Rolling pin
Rullo
Rollwalze
Rouleau
Rodillo amasador

| art. | Ø cm. | l. cm. | € |
|----------|-------|--------|-------|
| 47037-30 | 8 | 30 | 74,47 |
| 47037-40 | 8 | 40 | 78,69 |



PE

Rolling pin
Rullo
Rollwalze
Rouleau
Rodillo amasador

| art. | Ø cm. | l. cm. | € |
|----------|-------|--------|-------|
| 47034-23 | 2,5 | 23 | 13,37 |
| 47034-51 | 5,0 | 50 | 56,58 |



W

Rolling pin
Rullo
Rollwalze
Rouleau
Rodillo amasador

| art. | Ø cm. | l. cm. | € |
|----------|-------|--------|-------|
| 47034-52 | 5 | 50 | 15,78 |



SS

Rolling pin
Rullo
Rollwalze
Rouleau
Rodillo amasador

| art. | Ø cm. | l. cm. | € |
|----------|-------|--------|-------|
| 47034-50 | 5 | 50 | 18,59 |



Pastry brush
Pennello per alimenti
Kuchenpinsel
Pinceaux à pâtissier
Pincel de cocina

| art. | cm. | U. Pack | € |
|----------|-----|---------|-------|
| 47644-30 | 3 | 1 | 8,44 |
| 47644-40 | 4 | 1 | 9,45 |
| 47644-50 | 5 | 1 | 10,35 |
| 47644-60 | 6 | 1 | 9,75 |
| 47644-70 | 7 | 1 | 10,75 |

Synthetic bristles. Resistant up to 120°C and dishwasher safe. – Setole sintetiche. Resistente fino a 120°C e lavabile in lavastoviglie.



Pastry brush
Pennello per alimenti
Kuchenpinsel
Pinceaux à pâtissier
Pincel de cocina

| art. | cm. | U. Pack | € |
|----------|-----|---------|-------|
| 47642-30 | 3,0 | 6 | 3,92 |
| 47642-40 | 4,0 | 6 | 4,92 |
| 47642-50 | 5,0 | 6 | 6,13 |
| 47642-60 | 6,0 | 6 | 7,44 |
| 47642-70 | 7,5 | 6 | 10,05 |

Plastic handle, stainless steel ferrule.
Manico plastica, ghiera inox.



Pastry brush non-stick coated bristles
Pennello setole antiaderenti
Pinsel, antihafbeschichtete Borsten
Pinceau poils anti-adhérentes
Pincel cerdas antiadherentes

| art. | cm. | U. Pack | € |
|----------|-----|---------|-------|
| 47640-25 | 2,5 | 1 | 6,03 |
| 47640-35 | 3,5 | 1 | 7,54 |
| 47640-50 | 5,0 | 1 | 10,25 |
| 47640-59 | 6,0 | 1 | 11,36 |

Nylon bristles. Heat resistant up to +150°C.
Setole nylon. Resistente al calore fino a +150°C.



Pastry brush
Pennello per alimenti
Kuchenpinsel
Pinceaux à pâtissier
Pincel de cocina

| art. | cm. | U. Pack | € |
|----------|-----|---------|------|
| 47645-40 | 4 | 6 | 6,83 |
| 47645-60 | 6 | 6 | 9,15 |
| 47645-75 | 7,5 | 6 | 9,25 |

Natural bristles. – Setole naturali.



Pastry brush
Pennello per alimenti
Kuchenpinsel
Pinceaux à pâtissier
Pincel de cocina

| art. | cm. | U. Pack | € |
|----------|-----|---------|-------|
| 47646-40 | 4 | 6 | 7,84 |
| 47646-60 | 6 | 6 | 9,65 |
| 47646-75 | 7,5 | 6 | 11,16 |

Polyester bristles. – Setole in poliestere.



PP

Set 10 dough scrapers
Set 10 raschiatti
Teigschaber, 10 Stk.
Set 10 raclettes
Conjunto 10 rasquetas

| art. | dim. mm. | € |
|----------|----------|-------|
| 47621-01 | 216x128 | 20,90 |



PP

Set 10 dough scrapers
Set 10 raschiatti
Teigschaber, 10 Stk.
Set 10 raclettes
Conjunto 10 rasquetas

| art. | dim. mm. | € |
|----------|----------|------|
| 47621-02 | 120x86 | 7,64 |



PP

Set 10 dough scrapers
Set 10 raschiatti
Teigschaber, 10 Stk.
Set 10 raclettes
Conjunto 10 rasquetas

| art. | dim. mm. | € |
|----------|----------|------|
| 47621-03 | 120x88 | 7,64 |



PP

Set 10 dough scrapers
Set 10 raschiatti
Teigschaber, 10 Stk.
Set 10 raclettes
Conjunto 10 rasquetas

| art. | dim. mm. | € |
|----------|----------|------|
| 47621-04 | 121x81 | 7,64 |



PP

Set 10 dough scrapers
Set 10 raschiatti
Teigschaber, 10 Stk.
Set 10 raclettes
Conjunto 10 rasquetas

| art. | dim. mm. | € |
|----------|----------|------|
| 47621-05 | 148x99 | 7,64 |



PP

Set 10 decorating combs
Set 10 pettini decoratori
Dekorationskamm, 10 Stk
Set 10 peignes à decor
Conjunto 10 peines decoradores

| art. | dim. mm. | € |
|----------|----------|------|
| 47621-06 | 145x99 | 7,64 |



PP

Set 10 decorating combs

Set 10 pettini decoratori
Dekorationskamm, 10 Stk
Set 10 peignes à decor
Conjunto 10 peines decoradores

| art. | dim. mm. | € |
|----------|----------|------|
| 47621-07 | 110x80 | 7,64 |



PP

Set 10 decorating combs

Set 10 pettini decoratori
Dekorationskamm, 10 Stk
Set 10 peignes à decor
Conjunto 10 peines decoradores

| art. | dim. mm. | € |
|----------|----------|-------|
| 47621-08 | 216x128 | 18,59 |



SS

Set 3 decorating combs

Set 3 pettini decoratori
Dekorationskamm, 3 Stk
Set 3 peignes à decor
Conjunto 3 peines decoradores

| art. | dim. mm. | € |
|----------|----------|-------|
| 47625-03 | 100x100 | 19,70 |



SS

Sugar dredger

Spargi zucchero
Zuckerstreuer
Glacière à sucre
Dosificador para azúcar

| art. | Ø cm. | h. cm. | € |
|----------|-------|--------|-------|
| 47022-12 | 7 | 9 | 12,26 |



PE

Moisture bottle

Flacone per bagna
Sprühflasche
Bouteille à puncher
Frasco nebulizador

| art. | dim. cm. | lt. | € |
|----------|-------------|-----|-------|
| 47679-10 | 10x5,6x27,5 | 1 | 10,15 |



HDPE

Spraying bottle

Flacone nebulizzatore
Sprühflasche
Bouteille à puncher spray
Frasco nebulizador

| art. | dim. cm. | lt. | € |
|----------|----------|-----|-------|
| 47679-11 | 7x7x30 | 1 | 11,36 |



SS

Flour sifter

Setaccio farina
Einhand-Drücksieb
Tamiseur farine
Tamiz para harina

| art. | Ø cm. | gr. | € |
|----------|-------|-----|-------|
| 42607-05 | 12 | 500 | 15,68 |



Icing sugar sieve

Setaccio per zucchero a velo
Sieb für Puderzucker
Tamis à sucre glace
Cedazo para azúcar glas

| art. | Ø cm. | h. cm. | € |
|----------|-------|--------|-------|
| 47614-25 | 23 | 8 | 11,46 |



Sieve for flour

Setaccio rete farina
Sieb für Mehl
Tamis pour farine
Cedazo para harina

| art. | Ø cm. | h. cm. | € |
|----------|-------|--------|-------|
| 47615-25 | 23 | 8 | 11,46 |



Flour brush

Spazzola per farina
Mehlbürste
Brosse à pétrin
Cepillo para harina

| art. | cm. | € |
|----------|-----|-------|
| 42614-21 | 30 | 17,79 |

Horse hair. – Setole di cavallo.



SS

Display tray

Vassoio espositore
Auslegeplatte
Plat patissier
Bandeja pastelería

| art. | dim. cm. | € |
|----------|----------|-------|
| 47075-20 | 20x16x1 | 16,78 |
| 47075-30 | 30x21x1 | 24,22 |
| 47075-45 | 45x34x1 | 52,56 |



SS

Display tray

Vassoio espositore
Auslegeplatte
Plat patissier
Bandeja pastelería

| art. | dim. cm. | € |
|----------|-------------|-------|
| 42533-23 | 23x16,5x0,5 | 18,99 |
| 42533-26 | 26x19,5x0,5 | 23,12 |
| 42533-31 | 31x24x0,5 | 29,04 |
| 42533-36 | 36x28,5x0,5 | 39,60 |
| 42533-40 | 40x32,5x0,5 | 51,56 |



Display tray, aluminum

Vassoio espositore, alluminio
Auslegeplatte, Aluminium
Plat patissier, alu

Bandeja pastelería, aluminio

| art. | dim. cm. | € |
|----------|-------------|-------|
| 47070-37 | 37,5x24,5x1 | 18,59 |
| 47070-48 | 48x31x1 | 22,31 |
| 47070-60 | 60x40x1 | 38,29 |



SS

Vassoio espositore
Auslegeplatte
Plat patissier
Bandeja pastelería

| art. | dim. cm. | € |
|----------|-----------|-------|
| 47074-01 | 30x20x1,5 | 21,51 |
| 47074-02 | 40x10x1,5 | 19,10 |
| 47074-03 | 40x20x1,5 | 23,42 |
| 47074-04 | 40x30x1,5 | 29,95 |



SS

Vassoio espositore
Auslegeplatte
Plat patissier
Bandeja pastelería

| art. | dim. cm. | € |
|----------|-----------|-------|
| 47074-05 | 50x10x1,5 | 23,82 |
| 47074-06 | 60x6x1,5 | 19,40 |
| 47074-07 | 60x10x1,5 | 21,21 |
| 47074-08 | 60x20x1,5 | 31,66 |



NEW

Baking paper, microperforated

Carta Forno Microforata
Backpapier, microperforiert
Feuille de cuisson, microperforé
Papel de horno, microperforado

| art. | dim. cm. | pcs/pz | € |
|----------|-----------|--------|-------|
| 47682-40 | 59,2x39,2 | 200 | 53,77 |

Ideal for baking all leavened pastries, but also shortcrust pastry and meringues, it guarantees perfect baking in less time than traditional baking paper. Thanks to the micro-perforation, steam escapes faster during baking. This ensures a better passage of air, which also cools the products faster than with conventional baking paper.

Ideale per la cottura di tutte le paste lievitate, ma anche di bignè, pasta frolla, biscotti, pasta sfoglia e meringhe. Garantisce una cottura perfetta in minor tempo rispetto alla carta forno tradizionale. Durante la cottura, la microforatura permette al vapore acqueo di fuoriuscire più velocemente garantendo così un miglior passaggio dell'aria. Anche il raffreddamento dei prodotti è più rapido.



Baking paper, siliconized

Carta da forno siliconata
Baktrennfolie, silikonisiert
Feuille de cuisson, siliconée
Papel de horno siliconado

| art. | dim. cm. | pcs/pz | € |
|----------|----------|--------|--------|
| 47682-53 | 53x32,5 | 500 | 64,72 |
| 47682-60 | 60x40 | 500 | 119,80 |

Artificial parchment, bleached, g/m²: 41,0, both sides siliconized, reusable, for all kinds of dough.
Pergamena artificiale, sbiancata, g/m²: 41,0, siliconata fronte/retro, riutilizzabile, idonea per tutti i tipi di pasta.



Baking paper, PTFE coated

Carta da forno, rivestimento PTFE
Baktrennfolie, PTFE-beschichtet
Feuille de cuisson, revêtement PTFE
Papel de horno anti-adherente

| art. | dim. cm. | U. Pack | € |
|----------|----------|---------|------|
| 47681-60 | 60x40 | 10 | 9,45 |

Fiberglass tissue coated on both sides, can be used up to 500 times, tear-proof. Carefully dry after use. – Tessuto fibra di vetro rivestito fronte/retro, resistente alla trazione, antiaderente, riutilizzabile più di 500 volte. Asciugare dopo l'uso.



Baking sheet, silicone, microperforated

Tappeto silicone microforato
Silikonbackmatte, microperforiert
Tapis cuisson en silicone, microperforé
Tapete de cocción silicona, microperforado

| art. | GN | dim. cm. | € |
|----------|-----|----------|-------|
| 47691-53 | 1/1 | 53x32,5 | 29,25 |
| 47691-64 | - | 60x40 | 33,47 |



Baking sheet, silicone

Tappeto silicone
Silikonbackmatte
Tapis cuisson en silicone
Tapete de cocción silicona

| art. | GN | dim. cm. | € |
|----------|-----|----------|-------|
| 47689-53 | 1/1 | 53x32,5 | 27,24 |
| 47689-60 | - | 60x40 | 27,94 |



SILPAT Silicone baking sheet

Tappeto silicone
Silikonbackmatte
Tapis cuisson en silicone
Tapete de cocción silicona

| art. | GN | dim. cm. | € |
|----------|-----|----------|-------|
| 47680-40 | - | 40x30 | 23,72 |
| 47680-53 | 1/1 | 53x32,5 | 31,76 |
| 47680-60 | - | 60x40 | 44,12 |



SILPAIN Silicone baking sheet

Tappeto silicone
Silikonbackmatte
Tapis de cuisson en silicone
Tapete de cocción silicona

| art. | GN | dim. cm. | € |
|----------|-----|----------|-------|
| 47685-53 | 1/1 | 53x32,5 | 35,18 |
| 47685-60 | - | 60x40 | 44,12 |



ROUL'PAT Silicone baking sheet

Tappeto silicone
Silikonbackmatte
Tapis de cuisson en silicone
Tapete de cocción silicona

| art. | dim. cm. | € |
|----------|----------|-------|
| 47688-60 | 60x40 | 50,95 |



Baking beans, ceramic

Noccioli di cottura, ceramica
Blindbackkugeln, Keramik
Noyaux de cuisson, céramique
Núcleos de cocción, cerámica

| art. | Kg. | € |
|----------|-----|-------|
| 47011-01 | 1 | 19,90 |



Sheets, PET

Fogli
Blätter
Feuilles
Hojas

| art. | my | dim. cm. | pcs/pz | € |
|----------|----|----------|--------|-------|
| 47131-30 | 90 | 30x30 | 50 | 24,62 |
| 47131-60 | 90 | 60x40 | 50 | 35,78 |

Ribbons and sheets to coat molds, to make and unmold single portions and mignons. Non-stick for food use. Suitable for cooling in blast chiller, freezer and fridge, not suitable for cooking. Extra transparent, super resistant.

Nastri e fogli per rivestire stampi, per realizzare e sfornare monoporzioni e mignon. Antiaderenti per uso alimentare. Adatti al raffreddamento in abbattitore, congelatore e frigo, non adatti alla cottura. Extra trasparenti, super resistenti.



Cake ribbon, PET

Nastro per dolci
Tortenrandband
Ruban pâtissier
Cinta para tartas

| art. | my | h. cm. | mt. | € |
|----------|----|--------|-----|-------|
| 47130-25 | 90 | 2,5 | 305 | 26,63 |
| 47130-30 | 90 | 3,0 | 305 | 28,24 |
| 47130-35 | 90 | 3,5 | 305 | 30,45 |
| 47130-40 | 90 | 4,0 | 305 | 34,27 |
| 47130-45 | 90 | 4,5 | 305 | 37,29 |
| 47130-50 | 90 | 5,0 | 305 | 39,20 |
| 47130-55 | 90 | 5,5 | 305 | 41,21 |
| 47130-60 | 90 | 6,0 | 305 | 47,64 |



SS

Tart ring

Anello per torte
Tortenring
Cercle à tarte
Anillo para tartas

| art. | Ø cm. | h. cm. | € |
|----------|-------|--------|------|
| 47533-07 | 7 | 2 | 2,61 |
| 47533-08 | 8 | 2 | 2,81 |
| 47533-09 | 9 | 2 | 2,91 |
| 47533-10 | 10 | 2 | 3,02 |
| 47533-12 | 12 | 2 | 3,32 |
| 47533-14 | 14 | 2 | 3,32 |
| 47533-16 | 16 | 2 | 3,32 |
| 47533-18 | 18 | 2 | 3,82 |
| 47533-20 | 20 | 2 | 4,22 |
| 47533-22 | 22 | 2 | 4,62 |
| 47533-24 | 24 | 2 | 5,13 |
| 47533-26 | 26 | 2 | 5,73 |
| 47533-28 | 28 | 2 | 6,13 |
| 47533-30 | 30 | 2 | 6,73 |
| 47533-32 | 32 | 2 | 7,44 |



SS

Tart ring

Anello per torte
Tortenring
Cercle à tarte
Anillo para tartas

| art. | Ø cm. | h. cm. | € |
|----------|-------|--------|------|
| 47530-14 | 14 | 3,5 | 2,71 |
| 47530-16 | 16 | 3,5 | 3,02 |
| 47530-18 | 18 | 3,5 | 3,32 |
| 47530-20 | 20 | 3,5 | 3,52 |
| 47530-22 | 22 | 3,5 | 3,82 |
| 47530-24 | 24 | 3,5 | 4,12 |
| 47530-26 | 26 | 3,5 | 4,32 |
| 47530-28 | 28 | 3,5 | 4,82 |
| 47530-30 | 30 | 3,5 | 5,23 |



SS

Mousse ring

Anello per mousse
Schaumspeisenring
Cercle à mousse
Anillo para mousse

| art. | Ø cm. | h. cm. | € |
|----------|-------|--------|------|
| 47532-06 | 6,0 | 4,0 | 1,11 |
| 47532-07 | 7,5 | 4,0 | 1,31 |
| 47532-08 | 8,0 | 4,5 | 1,51 |
| 47532-12 | 12,0 | 4,5 | 2,31 |
| 47532-14 | 14,0 | 4,5 | 2,81 |
| 47532-16 | 16,0 | 4,5 | 3,62 |
| 47532-18 | 18,0 | 4,5 | 3,92 |
| 47532-20 | 20,0 | 4,5 | 4,12 |
| 47532-22 | 22,0 | 4,5 | 4,62 |
| 47532-24 | 24,0 | 4,5 | 5,23 |
| 47532-26 | 26,0 | 4,5 | 5,43 |



SS

Ice cream cake ring

Anello per torte gelato
Eistortenring
Cercle à vacherin
Circulo alto

| art. | Ø cm. | h. cm. | € |
|----------|-------|--------|------|
| 47534-07 | 7 | 9 | 2,31 |
| 47534-08 | 9 | 9 | 2,71 |
| 47534-10 | 9 | 11 | 3,32 |



SS

Ice cream cake ring

Anello per torte gelato
Eistortenring
Cercle à vacherin
Circulo alto

| art. | Ø cm. | h. cm. | € |
|----------|-------|--------|------|
| 47534-00 | 8 | 6 | 1,61 |
| 47534-01 | 10 | 6 | 1,71 |



SS

Ice cream cake ring

Anello per torte gelato
Eistortenring
Cercle à vacherin
Circulo alto

| art. | Ø cm. | h. cm. | € |
|----------|-------|--------|------|
| 47534-06 | 6 | 6 | 1,41 |
| 47534-16 | 16 | 6 | 4,82 |
| 47534-18 | 18 | 6 | 5,23 |
| 47534-20 | 20 | 6 | 5,73 |
| 47534-22 | 22 | 6 | 5,53 |
| 47534-24 | 24 | 6 | 6,63 |
| 47534-26 | 26 | 6 | 7,24 |
| 47534-28 | 28 | 6 | 7,84 |



SS

Cake setting ring, flexible

Anello regolabile, flessibile
Tortenring, verstellbar, flexibel
Cercle à tarte réglable, flexible
Anillo ajustable, flexible

| art. | Ø cm. | h. cm. | € |
|----------|---------|--------|------|
| 47529-07 | 16,5>32 | 8 | 8,34 |

MICROPERFORATED CAKE RINGS
FASCE MICROFORATE

SS



The micro-holes allow to support the edges of the cake avoiding to collapse during cooking. They also allow to expel the moisture from the dough, obtaining a perfect and always crispy cooking.

I microfori permettono di sostenere i bordi della torta evitandone il collasso in cottura. Consentono inoltre di espellere l'umidità, ottenendo una cottura sempre perfetta e croccante.



Cake ring, microperforated

Fascia microforata
Tarte-Rahmen perforiert
Cercle microperforé
Anillo tarta microperforado

| art. | Ø cm. | h. cm. | € |
|----------|-------|--------|-------|
| 47510-07 | 7 | 3,5 | 8,34 |
| 47510-09 | 9 | 3,5 | 9,05 |
| 47510-11 | 11 | 3,5 | 10,25 |
| 47510-13 | 13 | 3,5 | 11,86 |
| 47510-15 | 15 | 3,5 | 12,46 |
| 47510-17 | 17 | 3,5 | 13,57 |
| 47510-19 | 19 | 3,5 | 14,77 |
| 47510-21 | 21 | 3,5 | 16,68 |
| 47510-23 | 23 | 3,5 | 17,79 |
| 47510-25 | 25 | 3,5 | 19,70 |
| 47510-27 | 27 | 3,5 | 21,21 |
| 47510-29 | 29 | 3,5 | 21,81 |
| 47510-31 | 31 | 3,5 | 22,61 |



Cake ring, microperforated

Fascia microforata
Tarte-Rahmen perforiert
Cercle microperforé
Anillo tarta microperforado

| art. | Ø cm. | h. cm. | € |
|----------|-------|--------|-------|
| 47511-07 | 7 | 2 | 6,83 |
| 47511-09 | 9 | 2 | 7,24 |
| 47511-11 | 11 | 2 | 7,84 |
| 47511-13 | 13 | 2 | 9,55 |
| 47511-15 | 15 | 2 | 10,15 |
| 47511-17 | 17 | 2 | 10,75 |
| 47511-19 | 19 | 2 | 11,96 |
| 47511-21 | 21 | 2 | 12,46 |
| 47511-23 | 23 | 2 | 13,67 |
| 47511-25 | 25 | 2 | 18,19 |
| 47511-27 | 27 | 2 | 19,50 |
| 47511-29 | 29 | 2 | 20,10 |
| 47511-31 | 31 | 2 | 20,70 |

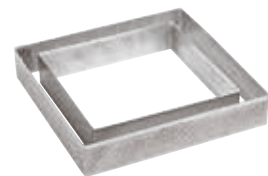

Cake ring, microperforated

Fascia microforata
Tarte-Rahmen perforiert
Cercle microperforé
Anillo tarta microperforado

| art. | dim. cm. | h. cm. | € |
|----------|----------|--------|-------|
| 47512-07 | 7x7 | 3,5 | 7,94 |
| 47512-09 | 9x9 | 3,5 | 8,94 |
| 47512-11 | 11x11 | 3,5 | 10,95 |
| 47512-13 | 13x13 | 3,5 | 12,86 |
| 47512-15 | 15x15 | 3,5 | 13,27 |
| 47512-17 | 17x17 | 3,5 | 13,97 |
| 47512-19 | 19x19 | 3,5 | 14,57 |
| 47512-21 | 21x21 | 3,5 | 15,38 |
| 47512-23 | 23x23 | 3,5 | 16,08 |
| 47512-25 | 25x25 | 3,5 | 21,61 |
| 47512-27 | 27x27 | 3,5 | 22,41 |
| 47512-29 | 29x29 | 3,5 | 23,22 |
| 47512-31 | 31x31 | 3,5 | 24,02 |



SS

Extensible frame
Telaio regolabile
Backrahm, verstellbar
Bande à tarte réglable
Marco para tarta, ajustable

| art. | cm. | h. cm. | € |
|----------|-------------|--------|-------|
| 47526-05 | 30x30>57x56 | 5 | 34,77 |



SS

Extensible frame
Telaio regolabile
Backrahm, verstellbar
Bande à tarte réglable
Marco para tarta, ajustable

| art. | cm. | h. cm. | € |
|----------|-------------|--------|------|
| 47528-05 | 19x28>34x54 | 5 | 9,15 |



SS

Extensible heart frame
Telaio cuore regolabile
Herz-Backrahm, verstellbar
Bande à tarte réglable
Marco para tarta, ajustable

| art. | cm. | h. cm. | € |
|----------|-----------|--------|------|
| 47542-00 | 14,5>26,5 | 5 | 3,72 |

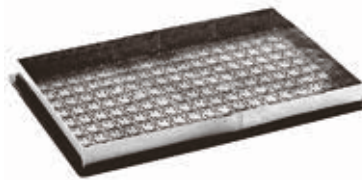

SS

Rectangle
Rettangolo
Rechteck
Rectangle
Rectangular

| art. | dim. cm. | € |
|----------|-------------|--------|
| 47527-55 | 55x35,5x4,5 | 137,48 |



SS

Rectangle
Rettangolo
Rechteck
Rectangle
Rectangular

| art. | dim. cm. | € |
|----------|----------|-------|
| 47546-18 | 18x36x5 | 22,11 |
| 47546-30 | 30x40x5 | 23,82 |
| 47546-40 | 40x60x5 | 29,45 |

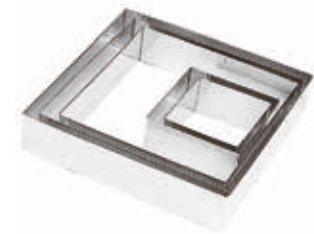

SS

Square
Quadrato
Viereck
Carré
Cuadrado

| art. | dim. cm. | € |
|----------|-----------|------|
| 47548-02 | 10x10x4,5 | 2,41 |
| 47548-03 | 18x18x4,5 | 5,03 |
| 47548-04 | 20x20x4,5 | 5,43 |
| 47548-05 | 22x22x4,5 | 5,83 |



SS

Rounded square
Quadrato bombato
Viereck, konvex
Carré arrondi
Cuadrado abombado

| art. | dim. cm. | € |
|----------|-----------|------|
| 47541-02 | 10x10x4,5 | 2,21 |
| 47541-03 | 18x18x4,5 | 4,72 |
| 47541-04 | 20x20x4,5 | 5,13 |



SS

Oval
Ovale
Oval
Ovale
Oval

| art. | dim. cm. | € |
|----------|-----------|------|
| 47547-22 | 24,5x20x4 | 5,33 |
| 47547-26 | 30x23x4 | 5,83 |
| 47547-30 | 33x26,5x4 | 6,63 |



SS

Comma
Virgola
Komma
Virgule
Coma

| art. | Ø cm. | h. cm. | € |
|----------|-------|--------|------|
| 47544-20 | 20 | 4 | 4,92 |
| 47544-25 | 25 | 4 | 5,33 |
| 47544-30 | 30 | 4 | 6,03 |





SS

Heart

Cuore
Herz
Coeur
Corazón

| art. | Ø cm. | h. cm. | € |
|----------|-------|--------|------|
| 47542-18 | 18 | 4 | 4,92 |
| 47542-20 | 20 | 4 | 5,13 |
| 47542-22 | 22 | 4 | 5,63 |
| 47542-24 | 24 | 4 | 5,83 |
| 47542-26 | 26 | 4 | 6,03 |



SS

Triangle

Triangolo
Dreieck
Triangle
Triángulo

| art. | Ø cm. | h. cm. | € |
|----------|-------|--------|------|
| 47540-02 | 12 | 4,5 | 2,21 |
| 47540-03 | 20 | 4,5 | 4,82 |
| 47540-04 | 22 | 4,5 | 5,43 |
| 47540-05 | 24 | 4,5 | 5,93 |



SS

Triangle

Triangolo
Dreieck
Triangle
Triángulo

| art. | Ø cm. | h. cm. | € |
|----------|-------|--------|------|
| 47538-23 | 23 | 4 | 4,72 |
| 47538-26 | 26 | 4 | 5,03 |



SS

Rectangle

Rettangolo
Rechteck
Rectangle
Rectangular

| art. | dim. cm. | € |
|----------|----------|-------|
| 47546-41 | 25x9x4 | 13,47 |
| 47546-42 | 30x9,1x4 | 13,97 |
| 47546-43 | 35x9,2x4 | 14,67 |

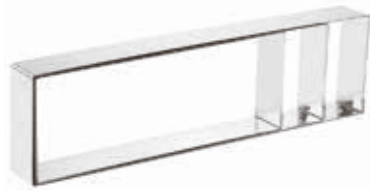

SS

Rectangle

Rettangolo
Rechteck
Rectangle
Rectangular

| art. | dim. cm. | € |
|----------|----------|-------|
| 47546-51 | 25x9x5 | 14,27 |
| 47546-52 | 30x9,1x5 | 15,78 |
| 47546-53 | 35x9,2x5 | 16,58 |

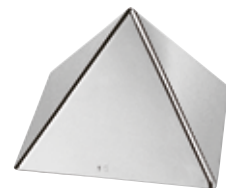

SS

Pyramid

Piramide
Pyramide
Piramide
Pirâmide

| art. | dim. cm. | h. cm. | € |
|----------|----------|--------|-------|
| 47535-09 | 9x9 | 6 | 5,53 |
| 47535-12 | 12x12 | 8 | - |
| 47535-17 | 17x17 | 12 | 11,66 |
| 47535-19 | 19x19 | 13 | 13,37 |



SS

Half sphere

Semi-sfera
Halbkugel
Demi-sphère
Semiesfera

| art. | Ø cm. | h. cm. | € |
|----------|-------|--------|-------|
| 47536-12 | 12 | 6 | - |
| 47536-14 | 14 | 7 | - |
| 47536-20 | 20 | 10 | 24,82 |



SS

Crème caramel

Crème caramel
Crème caramel
Crème caramel
Molde para flan

| art. | Ø cm. | h. cm. | ml. | € |
|----------|-------|--------|-----|------|
| 41660-10 | 7 | 5 | 150 | 4,72 |
| 41660-15 | 7 | 6 | 180 | 5,13 |

STAINLESS STEEL MOLDS
STAMPI INOX

NEW **SS**



For geometric baking, perfect for making travel cakes and other baked desserts. Stainless steel molds with tubular insert, easily removable after baking in order to fill the cakes also with non-baked fillings.

Stampi in acciaio inox per cottura geometrica, per realizzare travel cake ed altri dolci da forno. Inserto tubolare facilmente estraibile dopo la cottura, per consentire la farcitura del dolce anche con ripieni non da forno.



Travel cake carré short
Mold Mm 103x190 H 70

| art. | dim. mm. | ml. | € |
|----------|-----------|-----|-------|
| 47659-20 | 80x150x69 | 850 | 49,85 |



Travel cake carré
Mold Mm 82x290 H 64

| art. | dim. mm. | ml. | € |
|----------|-----------|-----|-------|
| 47659-21 | 60x250x60 | 900 | 57,39 |



Travel cake triangle
Mold Mm 88x290 H 85

| art. | dim. mm. | ml. | € |
|----------|-----------|-----|-------|
| 47659-22 | 82x250x80 | 890 | 90,75 |



Travel cake round
Mold Ø Mm 82 H 290

| art. | Ø mm. | h. mm. | ml. | € |
|----------|-------|--------|------|-------|
| 47659-24 | 78 | 250 | 1050 | 98,79 |



Travel cake cube
Mold Mm 103x86 H 83

| art. | dim. mm. | ml. | € |
|----------|----------|-----|-------|
| 47659-25 | 80x80x80 | 510 | 52,06 |



Travel cake dual
Mold Mm 255x84 H 62

| art. | Cake | dim. mm. | ml. | € |
|----------|-------|-----------|-----|-------|
| 47659-26 | block | 250x60x60 | 900 | 90,45 |
| | oval | 250x60x60 | 790 | |

Two shapes in one mold: Block & Oval. Thanks to the insert you can make either rectangular and oval cakes. – Due forme con uno stampo: Block & Oval. Grazie all'inserto si può realizzare sia il cake rettangolare che ovale.



Piepan, aluminum
Tortiera, alluminio
Tortenform, Aluminium
Tourtière, alu
Molde, aluminio

| art. | Ø cm. | h. cm. | € |
|----------|-------|--------|-------|
| 16940-28 | 28 | 5,0 | 13,87 |
| 16940-32 | 32 | 5,5 | 17,99 |
| 16940-36 | 36 | 6,0 | 20,30 |
| 16940-40 | 40 | 6,5 | 23,72 |



Savarin tin, aluminum
Ciambella, alluminio
Savarinform, Aluminium
Moule à savarin, alu
Molde para savarin, aluminio

| art. | Ø cm. | h. cm. | U. Pack | € |
|----------|-------|--------|---------|-------|
| 47060-06 | 6,0 | 2,5 | 3 | 3,62 |
| 47060-07 | 7,5 | 3,0 | 3 | 3,82 |
| 47060-09 | 9,0 | 3,5 | 3 | 4,22 |
| 47060-10 | 10,0 | 3,5 | 3 | 4,52 |
| 47060-12 | 12,0 | 5,5 | 3 | 7,84 |
| 47060-14 | 14,0 | 5,5 | 3 | 8,34 |
| 47060-16 | 16,0 | 5,5 | 3 | 9,45 |
| 47060-18 | 18,0 | 6,5 | 3 | 10,55 |
| 47060-20 | 20,0 | 6,5 | 3 | 11,56 |
| 47060-22 | 22,0 | 6,5 | 3 | 12,96 |
| 47060-24 | 24,0 | 8,5 | 3 | 14,27 |
| 47060-26 | 26,0 | 8,5 | 3 | 16,18 |
| 47060-30 | 30,0 | 8,5 | 3 | 23,32 |



Pandoro mold, aluminum
Stampo pandoro, alluminio
Pandoro-Form, Aluminium
Moule à pandoro, aluminium
Molde pandoro, aluminio

| art. | Ø cm. | h. cm. | gr. | € |
|----------|-------|--------|------|-------|
| 47063-01 | 10,8 | 8,0 | 100 | 12,46 |
| 47063-02 | 16,5 | 13,0 | 250 | 18,79 |
| 47063-05 | 19,5 | 14,5 | 500 | 20,50 |
| 47063-07 | 20,5 | 15,5 | 750 | 21,91 |
| 47063-10 | 23,0 | 17,0 | 1000 | 23,82 |



Gugelhupf, aluminum
Stampo americano, alluminio
Gugelhupfform, Aluminium
Moule à gugelhupf, alu
Molde gugelhupf, aluminio

| art. | Ø cm. | h. cm. | € |
|----------|-------|--------|-------|
| 47062-18 | 18 | 10,5 | 13,37 |
| 47062-20 | 20 | 11,0 | 16,08 |
| 47062-22 | 22 | 12,0 | 16,38 |



Plumcake, aluminum
Plumcake, alluminio
Plumcake, Aluminium
Plumcake, alu
Molde para plumcake, aluminio

| art. | dim. cm. | € |
|----------|----------|-------|
| 47064-18 | 18x80x6 | 7,64 |
| 47064-22 | 22x90x7 | 8,44 |
| 47064-26 | 26x10x8 | 10,95 |
| 47064-30 | 30x11x9 | 13,57 |



Beaker shaped tin, aluminum
Stampo per babà, alluminio
Timbalform, Aluminium
Moule à dariole, alu
Molde, aluminio

| art. | Ø cm. | h. cm. | U. Pack | € |
|----------|-------|--------|---------|------|
| 47066-03 | 3 | 3,5 | 10 | 2,21 |
| 47066-04 | 4 | 4,5 | 10 | 2,31 |
| 47066-05 | 5 | 5,5 | 10 | 2,71 |
| 47066-06 | 6 | 6,0 | 10 | 3,02 |
| 47066-07 | 7 | 7,0 | 10 | 3,12 |
| 47066-08 | 8 | 8,0 | 10 | 3,72 |



Crème caramel, aluminum
Crème caramel, alluminio
Crème caramel, Aluminium
Crème caramel, alu
Molde crème caramel, aluminio

| art. | Ø cm. | h. cm. | U. Pack | € |
|----------|-------|--------|---------|------|
| 41659-06 | 6 | 4,8 | 6 | 2,91 |
| 41659-07 | 7 | 5,0 | 6 | 3,02 |
| 41659-08 | 8 | 5,3 | 6 | 3,22 |



Cassata mold, aluminum
Stampo cassata, alluminio
Cassataform, Aluminium
Moule à cassata, alu
Molde para cassata, aluminio

| art. | Ø cm. | h. cm. | € |
|----------|-------|--------|-------|
| 47068-12 | 12 | 10 | 12,86 |
| 47068-15 | 15 | 12 | 16,48 |



Zuccotto mold, aluminum
Stampo per zuccotto, alluminio
Zuccottoform, Aluminium
Moule à zuccotto, alu
Molde para zuccotto, aluminio

| art. | Ø cm. | € |
|----------|-------|-------|
| 47069-10 | 10 | 4,42 |
| 47069-12 | 12 | 5,83 |
| 47069-14 | 14 | 6,73 |
| 47069-16 | 16 | 8,14 |
| 47069-18 | 18 | 9,45 |
| 47069-20 | 20 | 12,66 |

MODULAR SYSTEM BASE=LID EXTENSIBLE HEIGHT
SISTEMA MODULARE BASE=COPERCHIO ALTEZZA ESTENSIBILE



Modular system, the base and lid are the same element and due to the extender insert it is possible to increase capacity. Equipped with rotation system that allows steam to escape. On request dimensions 80x80 cm.

Sistema modulare, base e coperchio sono lo stesso elemento e grazie all'inserto estensore è possibile aumentare la capacità. Provvisto di sistema rotabile, per la fuoriuscita del vapore. A richiesta nelle dimensioni 80x80 cm.



Base and lid

Base e coperchio
 Basis und Abdeckung
 Base et couvercle
 Base y tapa

| art. | cm. ext. | cm. int. | € |
|----------|-----------|-----------|-------|
| 44975-50 | 57x57x9,5 | 51x51x6,3 | 49,75 |

Extender

Estensore
 Aufsatz
 Réhausse
 Extensión

| art. | cm. ext. | cm. int. | € |
|----------|-----------|---------------|-------|
| 44975H50 | 57x57x9,5 | 51x51x7,5x9,5 | 48,04 |

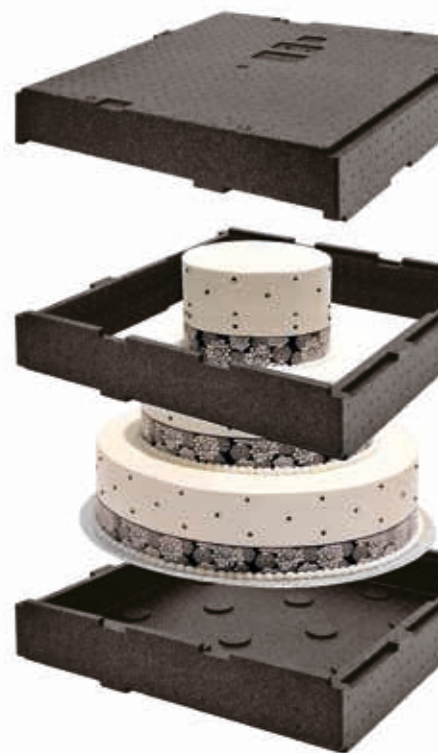

NON STICK CAKE MOLDS TORTIERE ANTIADERENTI

PASTRY
PASTICCERIA



Wash the mold before the first use. Slightly grease inside surface with oil, butter or margarine before baking. Allow cake to cool down a little before removing from the mold. For the cleaning, hand-wash with dish soap and dry the mold immediately after washing. Use only in traditional ovens (no microwave). Do not use sharp objects or others metal tools which could damage the pan surface. Do not use on a flame or other direct heat source, including stove tops. Do not exceed 230°C. Non-stick coating PFOA free.

Lavare lo stampo prima di utilizzarlo la prima volta. Ungere leggermente l'interno con olio, burro o margarina prima di infornare. Prima di sfornare, lasciare raffreddare per qualche minuto. Lavare a mano con detersivi liquidi ed asciugare lo stampo immediatamente dopo. Utilizzare esclusivamente in forni tradizionali (no microonde). Non utilizzare oggetti appuntiti, polveri abrasive o pagliette metalliche che possano rigare la superficie degli stampi. Evitare il contatto con fonti di calore dirette o fiamma libera. Non superare la temperatura massima di 230°C. Rivestimento antiaderente privo di PFOA.



Pine mold

Tortiera pino
Tannenbaumform
Tourtière pin
Molde pino

| art. | dim. cm. | € |
|----------|-----------|------|
| 47005-24 | 17x24x8,5 | 5,93 |



Star mold

Tortiera stella
Sternform
Tourtière étoile
Molde estrella

| art. | dim. cm. | € |
|----------|-----------|------|
| 47006-25 | 25x25x4,5 | 7,44 |



Crispy tart pan

Tortiera forata
Tortenform, gelocht
Tourtière perforée
Molde perforado

| art. | Ø cm. | h. cm. | € |
|----------|-------|--------|-------|
| 41729-30 | 29/27 | 1,5 | 11,56 |
| 41729-34 | 33/30 | 1,5 | 16,08 |



Round cake tin

Tortiera tonda
Tortenform, rund
Tourtière ronde
Molde redondo

| art. | Ø cm. | h. cm. | U. Pack | € |
|----------|-------|--------|---------|-------|
| 47739-12 | 12 | 2,1 | 6 | 3,92 |
| 47739-24 | 24 | 2,3 | 1 | 6,73 |
| 47739-28 | 28 | 2,3 | 1 | 9,15 |
| 47739-32 | 32 | 2,5 | 1 | 10,95 |



Round cake tin

Tortiera tonda
Tortenform, rund
Manqué rond uni
Molde redondo

| art. | Ø cm. | h. cm. | € |
|----------|-------|--------|-------|
| 47710-12 | 12 | 3,0 | 4,12 |
| 47710-16 | 16 | 4,0 | 5,23 |
| 47710-20 | 20 | 4,5 | 6,43 |
| 47710-24 | 24 | 5,0 | 8,34 |
| 47710-28 | 28 | 5,0 | 9,65 |
| 47710-32 | 32 | 5,5 | 11,36 |



Round mold, fluted edges

Tortiera festonata
Runde Obsttortenform
Tourtière ronde bord cannelé
Molde rizado

| art. | Ø cm. | h. cm. | € |
|----------|-------|--------|------|
| 47709-20 | 20 | 2,5 | 5,93 |
| 47709-24 | 24 | 2,5 | 7,24 |
| 47709-28 | 28 | 2,5 | 8,94 |
| 47709-32 | 32 | 2,5 | 9,95 |



Round mold, fluted, loose bottom

Tortiera festonata, fondo mobile
Tortenform, gewellter Rand, Heheboden
Tourtière cannelée, fond amovible
Molde acanalado, rizado, fondo desmontable

| art. | Ø cm. | h. cm. | € |
|----------|-------|--------|-------|
| 47712-20 | 20 | 2,5 | 7,74 |
| 47712-24 | 24 | 2,5 | 8,94 |
| 47712-28 | 28 | 2,5 | 10,95 |
| 47712-32 | 32 | 2,5 | 14,77 |



Savarin tin

Ciambella
Savarinform
Moule pour savarin
Molde Savarin

| art. | Ø cm. | h. cm. | U. Pack | € |
|----------|-------|--------|---------|-------|
| 47711-08 | 8 | 2,0 | 6 | 4,32 |
| 47711-12 | 12 | 2,5 | 6 | 5,33 |
| 47711-22 | 22 | 4,5 | 1 | 9,25 |
| 47711-24 | 24 | 5,0 | 1 | 10,15 |
| 47711-26 | 26 | 6,2 | 1 | 11,86 |



Trois Frères cake ring

Tortiera trois frères
Frankfurter Kranzform
Tourtière trois frères
Molde trois frères

| art. | Ø cm. | h. cm. | € |
|----------|-------|--------|-------|
| 47713-22 | 22 | 5,5 | 17,79 |



Gugelhupf cake pan

Stampo americano
Gugelhupfppform
Moule à gugelhupf
Molde gugelhupf

| art. | Ø cm. | h. cm. | € |
|----------|-------|--------|-------|
| 47705-22 | 22 | 10 | 10,95 |



Loaf pan

Tortiera rettangolare
Königskuchenform
Cake embouti
Molde rectangular

| art. | dim. cm. | € |
|----------|------------|------|
| 47714-26 | 26x9,5x7,5 | 8,44 |
| 47714-28 | 28x10x7,5 | 8,74 |



Rectangular mold, loose plate bottom

Tortiera, fondo mobile
Backform, gerippt, Heheboden
Tourtière cannelée, fond amovible
Molde fondo desmontable

| art. | dim. cm. | € |
|----------|-----------|-------|
| 47717-35 | 35x11x2,5 | 12,36 |

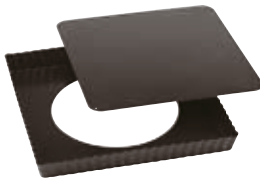

Square mold, fluted, loose bottom

Tortiera festonata, fondo mobile
Tortenform, gewellter Rand, Heheboden
Tourtière carrée, cannelée, fond amovible
Molde cuadrado, rizado, fondo desmontable

| art. | dim. cm. | € |
|----------|-----------|-------|
| 47738-23 | 23x23x2,5 | 11,26 |



Baking mold Daisy

Tortiera margherita
Margeriten-Backform
Moule à marguerite
Molde margarita

| art. | Ø cm. | h. cm. | € |
|----------|-------|--------|------|
| 47718-20 | 20 | 6 | 9,45 |



Round mold, fluted, loose bottom

Tortiera festonata, fondo mobile
Tortenform, gewellter Rand, Heheboden
Tourtière cannelée, fond amovible
Molde acanalado, fondo desmontable

| art. | Ø cm. | h. cm. | U. Pack | € |
|----------|-------|--------|---------|-------|
| 47719-10 | 10 | 3 | 6 | 4,82 |
| 47719-24 | 25 | 5 | 1 | 11,16 |



Round mold, fluted, loose bottom

Tartelletta festonata, fondo mobile
Runde, gewellte Tortellets, Heheboden
Tartelette ronde cannelée, fond amovible
Molde redondo rizado, fondo desmontable

| art. | Ø cm. | h. cm. | U. Pack | € |
|----------|-------|--------|---------|------|
| 47758-10 | 10 | 1,8 | 6 | 4,22 |
| 47758-12 | 12 | 2,0 | 6 | 5,13 |



Charlotte mold

Charlotte
Charlotte-Form
Charlotte
Molde Charlotte

| art. | Ø cm. | h. cm. | U. Pack | € |
|----------|-------|--------|---------|-------|
| 47734-18 | 18 | 10 | 6 | 13,47 |



Bavaois mold

Bavarese
Bayerische-Kuchenform
Moule Bavaois
Molde Bávaro

| art. | Ø cm. | h. cm. | € |
|----------|-------|--------|------|
| 47735-18 | 18 | 9 | 8,94 |



Rectangular cake mold

Tortiera rettangolare
Königskuchenform
Cake évasé
Molde ensanchado

| art. | dim. cm. | € |
|----------|------------|-------|
| 47733-18 | 18x7,5x6,5 | 10,85 |
| 47733-24 | 24x9x7,5 | 15,08 |
| 47733-30 | 30x10x8 | 17,19 |
| 47733-36 | 36x10,5x8 | 18,59 |



Folding loaf pan

Tortiera rettangolare apribile
Aufklappbare-Königskuchenform
Cake ouvrant
Molde rectangular desmontable

| art. | dim. cm. | € |
|----------|-----------|-------|
| 47715-30 | 30x10x7,5 | 14,17 |





Loaf pan with hinges, loose bottom
Bacinella paté con cerniera, fondo mobile
Springkastenform, Heheboden
Pâté à charnière, fond démontable
Molde con bisagra, fondo desmontable

| art. | dim. cm. | € |
|----------|----------|-------|
| 47736-30 | 30x8x8 | 17,89 |
| 47736-35 | 35x8x8 | 18,79 |
| 47736-40 | 40x8x8 | 20,80 |
| 47736-50 | 50x8x8 | 22,31 |



Mini paté mold
Stampo mini-paté
Pastetenkastenform
Mini-pâté à croûte
Molde minipaté

| art. | dim. cm. | € |
|----------|----------|-------|
| 47018-30 | 30x4x6 | 73,67 |
| 47018-50 | 50x4x6 | 87,64 |



Loaf pan
Stampo carré
Königskuchenform
Cake évasé
Molde ensanchado

| art. | dim. cm. | € |
|----------|------------|------|
| 47752-16 | 14x6,5x4 | 3,12 |
| 47752-21 | 17x9,5x5,5 | 4,02 |



Fluted loaf pan
Stampo carré, fondo festonato
Königskuchenform, gerippt
Cake évasé, fond cannelé
Molde ensanchado, fondo rizado

| art. | dim. cm. | € |
|----------|----------|------|
| 47753-31 | 31x12x5 | 6,93 |



Baguette baking pan
Teglia baguettes
Baguetteform
Plaque à baguettes
Placa para baguettes

| art. | dim. cm. | € |
|----------|-------------|-------|
| 47014-35 | 35x24,5x2,5 | 10,95 |



Oval aspic mold
Aspic ovale
Ovale Aspikform
Aspic ovale
Molde oval

| art. | dim. cm. | U. Pack | € |
|----------|-------------|---------|------|
| 47726-07 | 7,5x5,5x3,8 | 6 | 3,62 |



Oval aspic mold, star bottom
Aspic ovale, fondo stella
Ovale Aspikform, Sternboden
Aspic ovale, étoilé
Molde oval, fondo estrella

| art. | dim. cm. | U. Pack | € |
|----------|-------------|---------|---|
| 47727-07 | 7,5x5,5x3,8 | 6 | - |



Rum baba mold
Stampo babà
Runde Babaform
Dariole embouti
Molde para babà

| art. | Ø cm. | h. cm. | U. Pack | € |
|----------|-------|--------|---------|------|
| 47728-06 | 6 | 6 | 6 | 4,02 |



Oak leaf tart mold
Tartelletta foglia di quercia
Törtchenform Eichenblatt
Tartelette feuille chêne
Molde pasteles

| art. | Ø cm. | h. cm. | U. Pack | € |
|----------|-------|--------|---------|------|
| 47759-12 | 12 | 2 | 6 | 3,42 |



Savarin mold
Tartelletta savarin
Savarin förmchen
Savarin
Molde savarin

| art. | Ø cm. | h. cm. | U. Pack | € |
|----------|-------|--------|---------|------|
| 47757-65 | 6,5 | 1,5 | 6 | 3,72 |
| 47757-80 | 8,0 | 2,0 | 6 | 3,92 |



Oval boat mold
Tartelletta barchetta
Schiffchen förmchen
Barquette unie
Molde barquilla

| art. | dim. cm. | U. Pack | € |
|----------|------------|---------|------|
| 47720-06 | 6x2x1 | 6 | 2,11 |
| 47720-08 | 8x3,3x1,2 | 6 | 2,21 |
| 47720-10 | 10x4,3x1,3 | 6 | 2,41 |
| 47720-12 | 12x5x1,3 | 6 | - |



Fluted oval boat mold
Tartelletta barchetta, festonata
Schiffchen förmchen, gerippt
Barquette, cannelée
Molde barquilla, rizado

| art. | dim. cm. | U. Pack | € |
|----------|------------|---------|------|
| 47721-08 | 8x4x1,2 | 6 | 2,11 |
| 47721-10 | 10x4,5x1,2 | 6 | 2,21 |
| 47721-12 | 12x5x1,4 | 6 | 2,41 |



Round plain mold

Tartelletta tonda
Backförmchen, rund
Tartelette ronde, unie
Molde redondo

| art. | Ø cm. | U. Pack | € |
|----------|-------|---------|------|
| 47722-05 | 5 | 6 | 2,11 |
| 47722-06 | 6 | 6 | 2,11 |
| 47722-07 | 7 | 6 | 2,21 |
| 47722-08 | 8 | 6 | 2,21 |
| 47722-10 | 10 | 6 | 2,81 |



Round fluted mold

Tartelletta tonda festonata
Backförmchen, rund, gerippt
Tartelette ronde, cannelée
Molde redondo, rizado

| art. | Ø cm. | U. Pack | € |
|----------|-------|---------|------|
| 47723-05 | 5 | 6 | 2,21 |
| 47723-06 | 6 | 6 | 2,41 |
| 47723-07 | 7 | 6 | 2,41 |
| 47723-08 | 8 | 6 | 2,81 |
| 47723-10 | 10 | 6 | 3,12 |
| 47723-12 | 12 | 6 | 3,62 |



Brioche mold

Tartelletta a brioche
Brioche-Förmchen
Tartelette brioche
Molde brioche

| art. | Ø cm. | U. Pack | € |
|----------|-------|---------|------|
| 47724-06 | 6 | 6 | 2,61 |
| 47724-08 | 8 | 6 | 3,02 |
| 47724-10 | 10 | 6 | 3,32 |
| 47724-11 | 11 | 6 | 4,02 |



Box of small assorted molds

Scatola tartelletta assortite
Satz Förmchen
Boîte petits fours, assortis
Surtido moldes

| art. | pcs/pz | € |
|----------|--------|--------|
| 47730-60 | 60 | 113,46 |



Friand mold

Tartelletta rettangolare
Friand-Förmchen
Friand
Molde rectangular

| art. | dim. cm. | U. Pack | € |
|----------|----------|---------|------|
| 47725-09 | 10x5x1,4 | 6 | 2,51 |



Small mold

Tartelletta
Törtchenform
Petit four
Molde pasteles

| art. | dim. cm. | U. Pack | € |
|----------|----------|---------|------|
| 47747-03 | 4,5x3 | 6 | 2,11 |

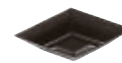

Small mold

Tartelletta
Törtchenform
Petit four
Molde pasteles

| art. | dim. cm. | U. Pack | € |
|----------|----------|---------|------|
| 47747-06 | 6x3 | 6 | 2,11 |



Small mold

Tartelletta
Törtchenform
Petit four
Molde pasteles

| art. | Ø cm. | h. cm. | U. Pack | € |
|----------|-------|--------|---------|------|
| 47747-10 | 4,0 | 1,0 | 6 | 1,91 |
| 47747-11 | 3,5 | 1,4 | 6 | 1,91 |



Small mold

Tartelletta
Törtchenform
Petit four
Molde pasteles

| art. | Ø cm. | U. Pack | € |
|----------|-------|---------|------|
| 47747-01 | 4,5 | 6 | 2,11 |



Small mold

Tartelletta
Törtchenform
Petit four
Molde pasteles

| art. | dim. cm. | U. Pack | € |
|----------|----------|---------|------|
| 47747-04 | 3,5x3,5 | 6 | 2,11 |



Small mold
Tartelletta
Törtchenform
Petit four
Molde pasteles

| art. | dim. cm. | U. Pack | € |
|----------|----------|---------|------|
| 47747-07 | 6x3 | 6 | 2,11 |



Small mold
Tartelletta
Törtchenform
Petit four
Molde pasteles

| art. | dim. cm. | U. Pack | € |
|----------|----------|---------|------|
| 47747-05 | 4,5x2,5 | 6 | 2,11 |



Small mold
Tartelletta
Törtchenform
Petit four
Molde pasteles

| art. | dim. cm. | U. Pack | € |
|----------|----------|---------|------|
| 47747-09 | 5x3 | 6 | 2,11 |



Madeleine sheet
Stampo per madeleines
Madeleine-Backblech
Plaque madeleines
Molde Madeleine

| art. | dim. cm. | € |
|----------|----------|------|
| 47731-12 | 26x20 | 9,85 |

Pcs/Pz 12 - 7x4,2 cm.



Madeleinette sheet
Stampo per madeleinettes
Madeleinette-Backblech
Plaque madeleinettes
Molde Madeleine

| art. | dim. cm. | € |
|----------|-----------|-------|
| 47732-20 | 39,5x12,5 | 12,96 |

Pcs/Pz 20 - 4,2x3 cm.



Cup bun pan
Stampo tartelletta
Backblech
Plaque tartelletes
Molde pasteles

| art. | dim. cm. | € |
|----------|-------------|------|
| 47748-35 | 31,5x24x1,2 | 5,83 |

Top Ø 68 - bottom Ø 45 - H 10 mm.



Snowman mold
Stampo pupazzo di neve
Schneemann-Backblech
Plaque bonhomme de neige
Molde muñeco de nieve

| art. | dim. cm. | € |
|----------|----------|------|
| 47762-23 | 23x5 | 5,33 |



Christmas style mold
Stampo di Natale
Weihnachts-Backblech
Plaque de Noël
Molde de Noel

| art. | dim. cm. | € |
|----------|---------------|---|
| 47750-06 | 31,5x21,5x2,5 | - |



Santa Claus mold
Stampo Babbo Natale
Weihnachtsmann-Backblech
Plaque Père Noël
Molde Papà Noel

| art. | dim. cm. | € |
|----------|----------|------|
| 47761-23 | 23x4,8 | 5,33 |



Easter muffin pan
Stampo motivi pasquali
Ostern-Backblech
Plaque Pâque
Molde Pascua

| art. | dim. cm. | € |
|----------|----------|------|
| 47749-35 | 35x27x3 | 9,95 |



Egg mold
Stampo uovo
Ostereierform
Moule à oeuf
Molde para huevos

| art. | dim. cm. | € |
|----------|----------|------|
| 47007-26 | 26x8,3 | 6,13 |



Easter rabbit mold
Stampo coniglietto di Pasqua
Osternhase-Backblech
Plaque lapin de Pâque
Molde conejo de Pascua

| art. | dim. cm. | € |
|----------|----------|------|
| 47764-12 | 12x2,6 | 2,21 |



Easter rabbit mold

Stampo coniglio di Pasqua
Osternhase-Backblech
Plaque lapin de Pâque
Molde conejo de Pascua

| art. | dim. cm. | € |
|----------|----------|------|
| 47764-28 | 28x5,4 | 6,23 |



Fluted springform pan

Tortiera a ciambella apribile
Savarinspringform
Moule à manqué savarin démontable
Molde savarin desmontable

| art. | Ø cm. | h. cm. | € |
|----------|-------|--------|-------|
| 47756-20 | 20,5 | 4,7 | - |
| 47756-24 | 24,0 | 6,8 | 20,90 |
| 47756-26 | 26,0 | 6,5 | 22,71 |
| 47756-28 | 28,0 | 6,7 | 26,33 |



Springform pan

Tortiera apribile
Springform
Manqué à manqué démontable
Molde desmontable

| art. | Ø cm. | h. cm. | € |
|----------|-------|--------|-------|
| 47754-20 | 20,5 | 6,5 | 10,05 |
| 47754-24 | 24,0 | 6,5 | 11,16 |
| 47754-26 | 26,0 | 6,5 | 12,26 |
| 47754-28 | 28,0 | 6,7 | 12,86 |



Springform pan with 6 bottoms

Tortiera apribile, 6 fondi
Springform mit 6 Böden
Moule à manqué démontable 6 fonds
Molde desmontable, 6 fondos

| art. | Ø cm. | h. cm. | € |
|----------|-------|--------|-------|
| 47755-26 | 26 | 6 | 18,99 |

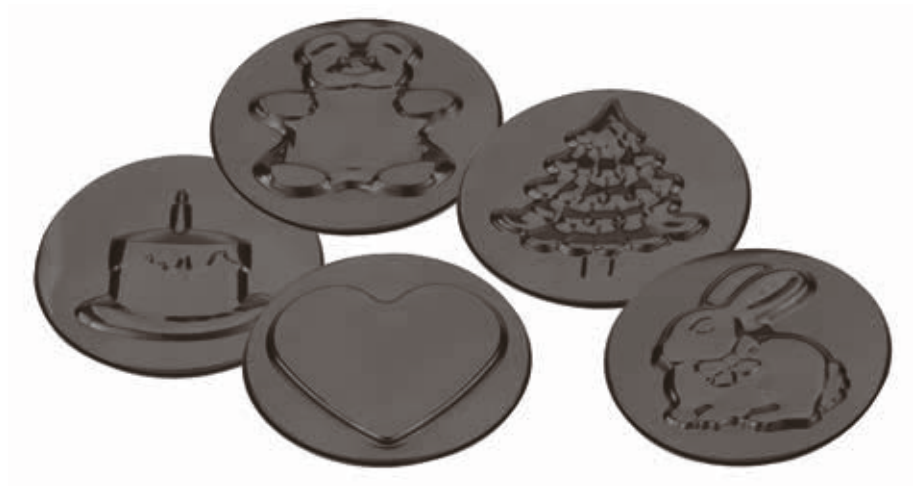

Log mold, plastic

Stampo per tronco, plastica
Kastenform, Kunststoff
Gouttière, plastique
Molde, plástico

| art. | dim. cm. | € |
|----------|------------|-------|
| 47659-01 | 48x6,5x6,5 | 29,45 |
| 47659-02 | 48x6,5x5 | 29,45 |
| 47659-04 | 48x5,0x4 | 26,63 |

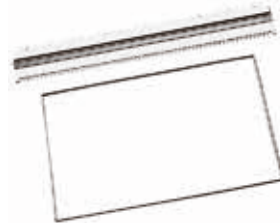

Comb for Charlotte with frame

Pettine Charlotte con telaio
Charlotte-Kamme mit Rahmen
Peigne à Charlotte avec cadre
Peine para Charlotte con marco

| art. | dim. cm. | € |
|----------|----------|--------|
| 47670-02 | 57x36,5 | 157,58 |



Comb with 5 rubber blades

Pettine con 5 fasce gomma
Kamm mit 5 Gummiklingen
Peigne avec 5 bandes à décor
Peine con 5 láminas de goma

| art. | dim. cm. | € |
|----------|----------|--------|
| 47672-05 | 70x10 | 312,96 |

SS

SS

MONOPORTION TRAY MOLDS
TEGLIE MONOPORZIONI



Tray cm. 60x40

Teglia
Blech
Plaque
Bandeja

| art. | dim. mm. | pcs/pz | gr. | € |
|----------|-----------|--------|-----|--------|
| 47651-01 | Ø 44 h 25 | 96 | 20 | 104,72 |
| 47651-02 | 55x35x25 | 96 | 20 | 104,72 |
| 47651-03 | 46x46x25 | 96 | 20 | 104,72 |
| 47651-04 | 60x38x25 | 96 | 20 | 104,72 |
| 47651-05 | 58x39x25 | 96 | 20 | 104,72 |
| 47651-07 | 38x38x25 | 96 | 20 | 104,72 |

Extractor

Estrattore
Extraktor
Extracteur
Extractor

| art. | dim. mm. | € |
|----------|-----------|------|
| 47656-01 | Ø 44 h 25 | 5,13 |
| 47656-02 | 55x35x25 | 5,13 |
| 47656-03 | 46x46x25 | 5,13 |
| 47656-04 | 60x38x25 | 5,13 |
| 47656-05 | 58x39x25 | 5,13 |
| 47656-07 | 38x38x25 | 5,13 |



Cutter

Tagliapasta
Ausstechform
Coupe-pâte
Cortador

| art. | dim. mm. | € |
|----------|-----------|------|
| 47655-01 | Ø 44 h 25 | 9,35 |
| 47655-02 | 55x35x25 | 9,35 |
| 47655-03 | 46x46x25 | 9,35 |
| 47655-04 | 60x38x25 | 9,35 |
| 47655-05 | 58x39x25 | 9,35 |
| 47655-07 | 38x38x25 | 9,35 |

Tray cm. 60x40

Teglia
Blech
Plaque
Bandeja

| art. | dim. mm. | pcs/pz | gr. | € |
|----------|-----------|--------|-----|--------|
| 47652-01 | Ø 67 h 40 | 35 | 75 | 115,27 |
| 47652-02 | 86x50x40 | 35 | 75 | 115,27 |
| 47652-03 | 74x71x40 | 35 | 75 | 115,27 |
| 47652-04 | 90x58x40 | 35 | 75 | 115,27 |
| 47652-05 | 88x60x40 | 35 | 75 | 115,27 |
| 47652-07 | 59x59x40 | 35 | 75 | 115,27 |



Extractor

Estrattore
Extraktor
Extracteur
Extractor

| art. | dim. mm. | € |
|----------|-----------|------|
| 47658-01 | Ø 67 h 40 | 5,13 |
| 47658-02 | 86x50x40 | 5,13 |
| 47658-03 | 74x71x40 | 5,13 |
| 47658-04 | 90x58x40 | 5,13 |
| 47658-05 | 88x60x40 | 5,13 |
| 47658-07 | 59x59x40 | 5,13 |

Cutter

Tagliapasta
Ausstechform
Coupe-pâte
Cortador

| art. | dim. mm. | € |
|----------|-----------|------|
| 47657-01 | Ø 67 h 40 | 9,35 |
| 47657-02 | 86x50x40 | 9,35 |
| 47657-03 | 74x71x40 | 9,35 |
| 47657-04 | 90x58x40 | 9,35 |
| 47657-05 | 88x60x40 | 9,35 |
| 47657-07 | 59x59x40 | 9,35 |

PRALINE'S SILICONE MOLDS CM 19X29
STAMPI IN SILICONE PER PRALINE CM 19X29



Practical, flexible and resistant silicone molds for sweet or salty creations (snaks, truffles, jellies, pralines). Perfect to make large quantities in short time. They withstand from -40° to +250°C. Can be used in the oven, refrigerator and blast chiller.

Pratici stampi in silicone flessibili e resistenti per creazioni dolci o salate (snack, tartufi, gelatine, praline). Ideali per realizzare grandi quantità in poco tempo. Resistono da -40° a +250°C. Utilizzabili in forno, frigorifero e abbattitore.

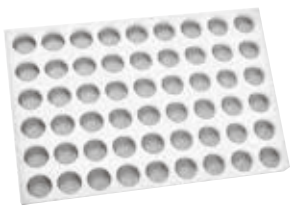

Chocoflex - psc/pz 54

| art. | Ø mm. | h. | € |
|----------|-------|----|-------|
| 47783-01 | 26 | 14 | 64,82 |

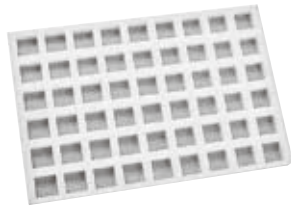

Chocoflex - psc/pz 54

| art. | dim. mm. | € |
|----------|----------|-------|
| 47783-02 | 23x23x14 | 64,82 |

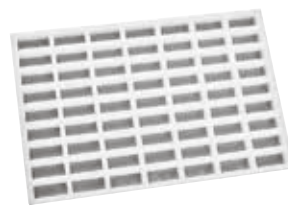

Chocoflex - psc/pz 63

| art. | dim. mm. | € |
|----------|------------|-------|
| 47783-03 | 35x14,5x14 | 64,82 |

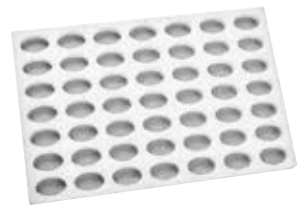

Chocoflex - psc/pz 49

| art. | dim. mm. | € |
|----------|----------|-------|
| 47783-04 | 32x21x14 | 64,82 |

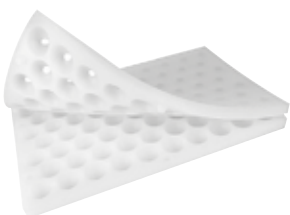

Chocoflex - psc/pz 54

| art. | Ø mm. | h. | € |
|----------|-------|----|--------|
| 47783-11 | 26 | 14 | 125,42 |



Chocoflex - psc/pz 40

| art. | Ø mm. | h. | € |
|----------|-------|----|-------|
| 47783-12 | 30-10 | 12 | 64,82 |



Chocoflex - psc/pz 15

| art. | dim. mm. | € |
|----------|----------|-------|
| 47783-13 | 90x30x19 | 64,82 |



Chocoflex - psc/pz 15

| art. | dim. mm. | € |
|----------|----------|-------|
| 47783-14 | 90x30x19 | 64,82 |

CHOCOLATE
CIOCCOLATO

PC



Polycarbonate chocolate molds. Mold size 17,5x27,5 cm.

Stampi polycarbonato. Misure stampo 17,5x27,5 cm.



NEW



NEW

Chocolate/Ciocolato Praline

| art. | Ø mm. | h. | pcs/pz | gr. | € |
|----------|-------|----|--------|-----|-------|
| 47861-25 | 35 | 16 | 24 | 11 | 30,25 |

Chocolate/Ciocolato Praline

| art. | dim. mm. | pcs/pz | gr. | € |
|----------|----------|--------|-----|-------|
| 47861-26 | 27x27x16 | 28 | 11 | 30,25 |



NEW



NEW

Chocolate/Ciocolato Praline

| art. | dim. mm. | pcs/pz | gr. | € |
|----------|----------|--------|-----|-------|
| 47861-20 | 29x29x18 | 24 | 11 | 30,25 |

Chocolate/Ciocolato Praline

| art. | dim. mm. | pcs/pz | gr. | € |
|----------|----------|--------|-----|-------|
| 47861-21 | 30x31x18 | 24 | 11 | 30,25 |



NEW



NEW

Chocolate/Ciocolato Praline

| art. | dim. mm. | pcs/pz | gr. | € |
|----------|----------|--------|-----|-------|
| 47861-27 | 40x19x16 | 25 | 10 | 30,25 |

Chocolate/Ciocolato Praline

| art. | dim. mm. | pcs/pz | gr. | € |
|----------|------------|--------|-----|-------|
| 47861-28 | 39,5x19x16 | 25 | 11 | 30,25 |



NEW



NEW

Chocolate/Ciocolato Praline

| art. | dim. mm. | pcs/pz | gr. | € |
|----------|----------|--------|-----|-------|
| 47861-29 | 40x18x16 | 25 | 11 | 30,25 |

Chocolate/Ciocolato Praline

| art. | dim. mm. | pcs/pz | gr. | € |
|----------|------------|--------|-----|-------|
| 47861-30 | 40,5x18x16 | 25 | 10 | 30,25 |





NEW

Chocolate/Cioccolato Praline

| art. | Ø mm. | h. | pcs/pz | gr. | € |
|----------|-------|----|--------|-----|-------|
| 47861-31 | 32 | 21 | 25 | 11 | 30,25 |



NEW

Chocolate/Cioccolato Praline

| art. | Ø mm. | h. | pcs/pz | gr. | € |
|----------|-------|------|--------|-----|-------|
| 47861-32 | 32 | 19,5 | 25 | 11 | 30,25 |



Chocolate/Cioccolato Praline

| art. | dim. mm. | pcs/pz | € |
|----------|----------|--------|-------|
| 47861-02 | 50x25x15 | 21 | 29,04 |



Chocolate/Cioccolato Praline

| art. | dim. mm. | pcs/pz | € |
|----------|----------|--------|-------|
| 47861-03 | 30x30x8 | 24 | 29,04 |



Chocolate/Cioccolato Praline

| art. | Ø mm. | h. | pcs/pz | € |
|----------|-------|----|--------|-------|
| 47861-04 | 35 | 8 | 24 | 29,04 |



Chocolate/Cioccolato Praline

| art. | dim. mm. | pcs/pz | € |
|----------|----------|--------|-------|
| 47861-05 | 33x33x15 | 24 | 31,86 |



Chocolate/Cioccolato Praline

| art. | dim. mm. | pcs/pz | € |
|----------|------------|--------|-------|
| 47861-07 | 39x18x15,5 | 30 | 31,86 |
| 47861-08 | 96x22x15,5 | 10 | 31,86 |



Chocolate/Cioccolato Praline

| art. | dim. mm. | pcs/pz | € |
|----------|------------|--------|-------|
| 47861-09 | 39x18x15,5 | 30 | 31,86 |
| 47861-10 | 96x22x17 | 10 | 31,86 |



Chocolate/Cioccolato Praline

| art. | dim. mm. | pcs/pz | € |
|----------|----------|--------|-------|
| 47861-11 | 39x20x16 | 27 | 31,86 |
| 47861-06 | 96x22x17 | 10 | 31,86 |



Chocolate/Cioccolato Praline

| art. | dim. mm. | pcs/pz | € |
|----------|----------|--------|-------|
| 47861-12 | 52x26x14 | 21 | 29,04 |



Chocolate/Cioccolato Praline

| art. | dim. mm. | pcs/pz | € |
|----------|----------|--------|-------|
| 47861-13 | 42x25x6 | 20 | 29,04 |



Chocolate/Cioccolato Praline

| art. | dim. mm. | pcs/pz | € |
|----------|-----------|--------|-------|
| 47861-14 | 123x27x12 | 8 | 29,04 |



Chocolate/Cioccolato Praline

| art. | dim. mm. | pcs/pz | € |
|----------|-----------|--------|-------|
| 47861-15 | 138x72x11 | 3 | 29,04 |



Chocolate/Cioccolato Praline

| art. | dim. mm. | pcs/pz | € |
|----------|----------|--------|-------|
| 47860-17 | 30x30x12 | 24 | 28,24 |



Chocolate/Cioccolato Praline

| art. | Ø mm. | h. | pcs/pz | € |
|----------|-------|----|--------|-------|
| 47860-18 | 27 | 17 | 24 | 28,24 |



Chocolate/Cioccolato Praline

| art. | Ø mm. | h. | pcs/pz | € |
|----------|-------|----|--------|-------|
| 47860-21 | 29 | 18 | 24 | 28,24 |



Chocolate/Cioccolato Praline

| art. | dim. mm. | pcs/pz | € |
|----------|----------|--------|-------|
| 47860-24 | 40x42x15 | 15 | 28,24 |



Chocolate/Ciocolato Praline

| art. | dim. mm. | pcs/pz | € |
|----------|----------|--------|-------|
| 47860-27 | 27x27x13 | 28 | 28,24 |



Chocolate/Ciocolato Praline

| art. | dim. mm. | pcs/pz | € |
|----------|----------|--------|-------|
| 47860-31 | 33x25x12 | 24 | 28,24 |



Chocolate/Ciocolato Praline

| art. | Ø mm. | h. | pcs/pz | € |
|----------|-------|----|--------|-------|
| 47860-35 | 30 | 19 | 28 | 28,24 |



Chocolate/Ciocolato Praline

| art. | dim. mm. | h. | pcs/pz | € |
|----------|----------|----|--------|-------|
| 47860-36 | 25x25x25 | 25 | 40 | 28,24 |



Chocolate/Ciocolato Praline

| art. | dim. mm. | pcs/pz | € |
|----------|----------|--------|-------|
| 47860-37 | 36x22x20 | 36 | 28,24 |



Chocolate/Ciocolato Praline

| art. | dim. mm. | pcs/pz | € |
|----------|------------|--------|-------|
| 47860-38 | 48x18,5x19 | 16 | 28,24 |



Chocolate/Ciocolato Praline

| art. | dim. mm. | pcs/pz | € |
|----------|----------|--------|-------|
| 47860-39 | 30x18x15 | 30 | 28,24 |



Chocolate/Ciocolato Praline

| art. | Ø mm. | h. | pcs/pz | € |
|----------|-------|----|--------|-------|
| 47860-40 | 29 | 21 | 40 | 28,24 |



Chocolate/Ciocolato Praline

| art. | dim. mm. | pcs/pz | € |
|----------|----------|--------|-------|
| 47860-42 | 35x23x16 | 36 | 28,24 |



Chocolate/Ciocolato Praline

| art. | dim. mm. | pcs/pz | € |
|----------|----------|--------|---|
| 47860-43 | 38x28x18 | 30 | - |



Chocolate/Ciocolato Praline

| art. | dim. mm. | pcs/pz | € |
|----------|----------|--------|-------|
| 47860-44 | 28x32x15 | 32 | 28,24 |



Chocolate/Ciocolato Praline

| art. | dim. mm. | pcs/pz | € |
|----------|----------|--------|-------|
| 47860-46 | 35x20x17 | 30 | 28,24 |



Chocolate/Ciocolato Praline

| art. | Ø mm. | h. | pcs/pz | € |
|----------|-------|----|--------|-------|
| 47860-48 | 28 | 24 | 40 | 28,24 |



Chocolate/Ciocolato Praline

| art. | Ø mm. | h. | pcs/pz | € |
|----------|-------|----|--------|-------|
| 47860-49 | 30 | 22 | 28 | 28,24 |



Chocolate/Ciocolato Praline

| art. | Ø mm. | h. | pcs/pz | € |
|----------|-------|----|--------|-------|
| 47860-50 | 26 | 15 | 35 | 28,24 |



Chocolate/Ciocolato Praline

| art. | dim. mm. | pcs/pz | € |
|----------|----------|--------|-------|
| 47860-53 | 22x22x22 | 28 | 28,24 |



Chocolate/Ciocolato Praline

| art. | dim. mm. | pcs/pz | € |
|----------|----------|--------|-------|
| 47860-55 | 26x20x21 | 28 | 28,24 |



Chocolate/Ciocolato Praline

| art. | Ø mm. | h. | pcs/pz | € |
|----------|-------|----|--------|-------|
| 47860-56 | 24 | 21 | 28 | 28,24 |





Chocolate/Ciocolato Praline

| art. | dim. mm. | pcs/pz | € |
|----------|----------|--------|-------|
| 47860-58 | 17x12x5 | 130 | 28,24 |



Chocolate/Ciocolato Praline

| art. | Ø mm. | h. | pcs/pz | € |
|----------|-------|------|--------|-------|
| 47860-60 | 25 | 18,5 | 28 | 28,24 |



Chocolate/Ciocolato Praline

| art. | dim. mm. | pcs/pz | € |
|----------|------------|--------|---|
| 47860-61 | 30x20x17,5 | 28 | - |



Chocolate/Ciocolato Praline

| art. | Ø mm. | h. | pcs/pz | € |
|----------|-------|----|--------|-------|
| 47860-62 | 27 | 20 | 30 | 28,24 |



Chocolate/Ciocolato Praline

| art. | Ø mm. | h. | pcs/pz | € |
|----------|-------|----|--------|-------|
| 47860-63 | 27 | 20 | 30 | 28,24 |



Chocolate/Ciocolato Praline

| art. | dim. mm. | pcs/pz | € |
|----------|----------|--------|-------|
| 47860-66 | 25x25x15 | 30 | 28,24 |



Chocolate/Ciocolato Praline

| art. | dim. mm. | pcs/pz | € |
|----------|----------|--------|-------|
| 47860-67 | 25x25x15 | 30 | 28,24 |



Chocolate/Ciocolato Praline

| art. | Ø mm. | h. | pcs/pz | € |
|----------|-------|----|--------|---|
| 47860-68 | 28 | 25 | 40 | - |



Chocolate/Ciocolato Praline

| art. | dim. mm. | pcs/pz | € |
|----------|----------|--------|-------|
| 47860-69 | 40x20x18 | 30 | 28,24 |



Chocolate/Ciocolato Praline

| art. | dim. mm. | pcs/pz | € |
|----------|----------|--------|-------|
| 47860-73 | 31x22x22 | 5x6 | 28,24 |



Chocolate/Ciocolato Praline

| art. | dim. mm. | pcs/pz | € |
|----------|----------|--------|-------|
| 47860-71 | 26x26x20 | 30 | 28,24 |



Chocolate/Ciocolato Praline

| art. | dim. mm. | pcs/pz | € |
|----------|----------|--------|-------|
| 47860-74 | 32x32x4 | 24 | 28,24 |



Chocolate/Ciocolato Praline

| art. | dim. mm. | pcs/pz | € |
|----------|----------|--------|-------|
| 47860-70 | 40x18x15 | 30 | 28,24 |



Chocolate/Ciocolato Praline

| art. | dim. mm. | pcs/pz | € |
|----------|----------|--------|-------|
| 47860-75 | 20x20x16 | 28 | 28,24 |



Chocolate/Ciocolato Praline

| art. | dim. mm. | pcs/pz | € |
|----------|----------|--------|-------|
| 47860-81 | 30x18x15 | 30 | 28,24 |



Chocolate/Ciocolato Praline

| art. | dim. mm. | pcs/pz | € |
|----------|----------|--------|---|
| 47860-83 | 30x30x15 | 24 | - |



Chocolate/Ciocolato Praline

| art. | Ø mm. | h. | pcs/pz | € |
|----------|-------|----|--------|-------|
| 47860-84 | 26 | 19 | 35 | 28,24 |



Chocolate/Ciocolato Praline

| art. | dim. mm. | pcs/pz | € |
|----------|----------|--------|-------|
| 47860-85 | 35x22x16 | 35 | 28,24 |



Chocolate/Ciocolato Praline

| art. | dim. mm. | pcs/pz | € |
|----------|----------|--------|-------|
| 47860-95 | 25x25x13 | 24 | 28,24 |



Chocolate/Ciocolato Praline

| art. | Ø mm. | h. | pcs/pz | € |
|----------|-------|----|--------|-------|
| 47860-96 | 35 | 15 | 24 | 28,24 |



Chocolate/Ciocolato Praline

| art. | dim. mm. | pcs/pz | € |
|----------|----------|--------|-------|
| 47862-31 | 28x28x16 | 28 | 29,04 |



Chocolate/Ciocolato Praline

| art. | dim. mm. | pcs/pz | € |
|----------|----------|--------|-------|
| 47862-32 | 24x24x18 | 28 | 29,04 |



Chocolate/Ciocolato Praline

| art. | dim. mm. | pcs/pz | € |
|----------|----------|--------|-------|
| 47862-33 | 40x42x16 | 15 | 29,04 |



Chocolate/Ciocolato Praline

| art. | dim. mm. | pcs/pz | € |
|----------|----------|--------|-------|
| 47862-34 | 41x24x20 | 20 | 29,04 |



Chocolate/Ciocolato Praline

| art. | dim. mm. | pcs/pz | € |
|----------|----------|--------|-------|
| 47862-35 | 30x30x11 | 28 | 29,04 |



Chocolate/Ciocolato Praline

| art. | dim. mm. | pcs/pz | € |
|----------|----------|--------|-------|
| 47862-36 | 35x23x17 | 24 | 29,04 |



Chocolate/Ciocolato Praline

| art. | dim. mm. | pcs/pz | € |
|----------|----------|--------|-------|
| 47860-89 | 27x27x20 | 28 | 29,04 |



Chocolate/Ciocolato Praline

| art. | Ø mm. | h. | pcs/pz | € |
|----------|-------|----|--------|-------|
| 47860-97 | 23 | 29 | 28 | 29,04 |



Chocolate/Ciocolato Praline

| art. | Ø mm. | h. | pcs/pz | € |
|----------|-------|------|--------|-------|
| 47860-98 | 23 | 28,5 | 28 | 29,04 |



Chocolate/Ciocolato Praline

| art. | dim. mm. | pcs/pz | € |
|----------|----------|--------|-------|
| 47860-99 | 75x70x22 | 6 | 29,04 |



Chocolate mini bars/Mini barrette

| art. | dim. mm. | pcs/pz | € |
|----------|----------|--------|-------|
| 47862-38 | 50x26x3 | 16 | 29,04 |



Chocolate mini bars/Mini barrette

| art. | dim. mm. | pcs/pz | € |
|----------|----------|--------|-------|
| 47862-39 | 74x33x5 | 12 | 29,04 |





Chocolate bars 3 pcs

Tavolette cioccolato 3 pz
Schokoladentafel 3 Stk
Tablettes chocolat 3 pcs
Tabletas chocolate 3 pz

| art. | dim. mm. | gr. | € |
|----------|-------------|-----|-------|
| 47870-50 | 140x69,5x11 | 100 | 29,04 |



Chocolate bars 3 pcs

Tavolette cioccolato 3 pz
Schokoladentafel 3 Stk
Tablettes chocolat 3 pcs
Tabletas chocolate 3 pz

| art. | dim. mm. | gr. | € |
|----------|-----------|-----|-------|
| 47870-51 | 138x68x11 | 100 | 29,04 |



Chocolate bars 3 pcs

Tavolette cioccolato 3 pz
Schokoladentafel 3 Stk
Tablettes chocolat 3 pcs
Tabletas chocolate 3 pz

| art. | dim. mm. | gr. | € |
|----------|-------------|-----|-------|
| 47870-52 | 140x70,5x10 | 100 | 29,04 |



Chocolate bars 3 pcs

Tavolette cioccolato 3 pz
Schokoladentafel 3 Stk
Tablettes chocolat 3 pcs
Tabletas chocolate 3 pz

| art. | dim. mm. | gr. | € |
|----------|---------------|-----|-------|
| 47870-53 | 139x69,5x11,5 | 100 | 29,04 |



NEW

Chocolate/Ciocolato Praline

| art. | dim. mm. | pcs/pz | gr. | € |
|----------|-----------|--------|-----|-------|
| 47861-23 | 97x64x130 | 1 | 110 | 30,25 |



NEW

Chocolate/Ciocolato Praline

| art. | dim. mm. | pcs/pz | gr. | € |
|----------|----------|--------|-----|-------|
| 47861-24 | 70x66x20 | 6 | 14 | 30,25 |



NEW

Chocolate/Ciocolato Praline

| art. | dim. mm. | pcs/pz | gr. | € |
|----------|-----------|--------|-----|-------|
| 47861-22 | 78x73x150 | 1 | 130 | 30,25 |



NEW

Chocolate/Ciocolato Praline

| art. | Ø mm. | h. | pcs/pz | gr. | € |
|----------|-------|-----|--------|-----|-------|
| 47861-33 | 75 | 120 | 2 | 45 | 30,25 |



NEW

Chocolate/Ciocolato Praline

| art. | Ø mm. | h. | pcs/pz | gr. | € |
|----------|-------|-----|--------|-----|-------|
| 47861-34 | 70 | 120 | 2 | 55 | 30,25 |



Polycarbonate molds mm. 275x175. To create small mignon and refined pralines with an original and inviting look.

Stampi in polycarbonato mm. 275x175 . Per creare piccoli mignon e raffinate praline dall'aspetto originale e invitante.



Mini choco fill

| art. | Ø mm. | h. | pcs/pz | € |
|----------|-------|----|--------|-------|
| 47862-64 | 27 | 31 | 28 | 29,45 |



Mini choco fill

| art. | Ø mm. | h. | pcs/pz | € |
|----------|-------|----|--------|-------|
| 47862-65 | 37 | 14 | 15 | 29,45 |



Mini choco fill

| art. | dim. mm. | pcs/pz | € |
|----------|----------|--------|-------|
| 47862-66 | 27x27x31 | 28 | 29,45 |



Mini choco fill

| art. | dim. mm. | pcs/pz | € |
|----------|----------|--------|-------|
| 47862-67 | 33x33x14 | 24 | 29,45 |



Mini choco fill

| art. | dim. mm. | pcs/pz | € |
|----------|----------|--------|-------|
| 47862-03 | 32x24x29 | 24 | 29,45 |



Mini choco fill

| art. | dim. mm. | pcs/pz | € |
|----------|----------|--------|-------|
| 47862-04 | 44x56x39 | 12 | 29,45 |



Mini choco fill

| art. | Ø mm. | h. | pcs/pz | € |
|----------|-------|----|--------|-------|
| 47862-05 | 40 | 17 | 15 | 29,45 |





Mini choco fill

| art. | dim. mm. | pcs/pz | € |
|----------|----------|--------|-------|
| 47862-06 | 33x31x20 | 24 | 29,45 |



Mini choco fill

| art. | dim. mm. | pcs/pz | € |
|----------|----------|--------|-------|
| 47862-07 | 33x33x23 | 24 | 29,45 |



Mini choco fill

| art. | dim. mm. | pcs/pz | € |
|----------|----------|--------|-------|
| 47862-08 | 44x55x23 | 12 | 29,45 |



Mini choco fill

| art. | Ø mm. | h. | pcs/pz | € |
|----------|-------|------|--------|-------|
| 47862-09 | 40 | 18,5 | 15 | 29,45 |



Mini choco fill

| art. | Ø mm. | h. | pcs/pz | € |
|----------|-------|----|--------|-------|
| 47862-10 | 32 | 37 | 20 | 29,45 |



Tray/Vassoio

| art. | dim. cm. | pcs/pz | € |
|----------|-----------|--------|-------|
| 47862C10 | 38x10x2,5 | 20 | 19,40 |



Chocolate/Ciocolato Decoration

| art. | dim. mm. | pcs/pz | gr. | € |
|----------|----------|--------|-----|---|
| 47862-70 | 64x26 | 16 | 2/3 | - |



Chocolate/Ciocolato Decoration

| art. | dim. mm. | pcs/pz | gr. | € |
|----------|----------|--------|-----|-------|
| 47862-72 | 110x7 | 22 | 3/4 | 31,86 |



Chocolate/Ciocolato Decoration

| art. | dim. mm. | pcs/pz | gr. | € |
|----------|----------|--------|-----|---|
| 47862-74 | 65x22 | 18 | 2/3 | - |



Letters & Numbers

| art. | h. cm. | € |
|----------|--------|-------|
| 47860-86 | 3 | 28,24 |

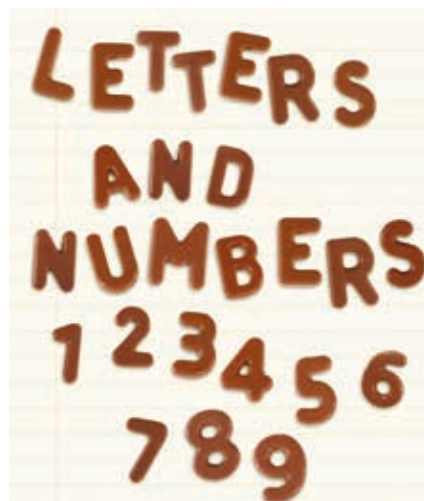

Hemispheres/Semisfere

| art. | Ø mm. | pcs/pz | € |
|----------|-------|--------|-------|
| 47861-16 | 20 | 45 | 29,04 |
| 47860-76 | 30 | 24 | 28,24 |



Hemispheres/Semisfere

| art. | Ø mm. | pcs/pz | € |
|----------|-------|--------|-------|
| 47861-17 | 40 | 15 | 29,04 |



Hemispheres/Semisfere

| art. | Ø mm. | pcs/pz | € |
|----------|-------|--------|-------|
| 47860-77 | 50 | 8 | 28,24 |



Hemispheres/Semisfere

| art. | Ø mm. | pcs/pz | € |
|----------|-------|--------|-------|
| 47861-18 | 60 | 6 | 29,04 |



Hemispheres/Semisfere

| art. | Ø mm. | pcs/pz | € |
|----------|-------|--------|-------|
| 47861-19 | 80 | 4 | 29,04 |



Hemispheres/Semisfere

| art. | Ø mm. | pcs/pz | € |
|----------|-------|--------|-------|
| 47860-78 | 100 | 2 | 28,24 |



Egg mold kit

Stampo uovo kit
Ostereierform-Kit
Moule à oeuf en kit
Molde huevo

| art. | Ø mm. | h. | pcs/pz | gr. | € |
|----------|-------|-----|--------|-----|-------|
| 47862-88 | 115 | 155 | 2 | 230 | 64,82 |

Thermoformed plastic. – Plastica termoformata.



Egg mold kit

Stampo uovo kit
Ostereierform-Kit
Moule à oeuf en kit
Molde huevo

| art. | Ø mm. | h. | pcs/pz | gr. | € |
|----------|-------|-----|--------|-----|---|
| 47862-87 | 120 | 185 | 2 | 280 | - |

Thermoformed plastic. – Plastica termoformata.



Egg mold kit

Stampo uovo kit
Ostereierform-Kit
Moule à oeuf en kit
Molde huevo

| art. | Ø mm. | h. | pcs/pz | gr. | € |
|----------|-------|-----|--------|-----|-------|
| 47862-89 | 122 | 185 | 2 | 270 | 64,82 |

Thermoformed plastic. – Plastica termoformata.





Half egg mold, PETG

Stampo mezzo uovo
Halbe Eierform
Moule demi oeuf
Molde medio huevo

| art. | dim. cm. | Kg. | € |
|----------|----------|---------|-------|
| 47876-11 | 17x25 | 0,5-1,0 | 43,32 |
| 47876-12 | 18x28 | 0,8-1,2 | 44,52 |
| 47876-13 | 34x25 | 1,5-2,0 | 58,59 |
| 47876-14 | 27x40 | 2,0-2,5 | 71,25 |



PC

Half egg mold

Stampo mezzo uovo
Halbe Eierform
Moule demi oeuf
Molde medio huevo

| art. | dim. mm. | pcs/pz | gr. | € |
|----------|----------|--------|-----|-------|
| 47862-80 | 44x64 | 10 | 25 | 29,45 |

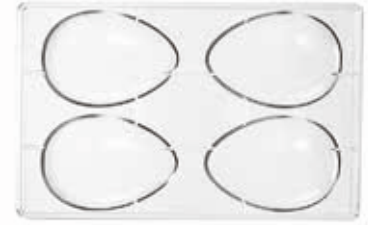

PC

Half egg mold

Stampo mezzo uovo
Halbe Eierform
Moule demi oeuf
Molde medio huevo

| art. | dim. mm. | pcs/pz | gr. | € |
|----------|----------|--------|-----|-------|
| 47862-81 | 75x105 | 4 | 70 | 29,45 |

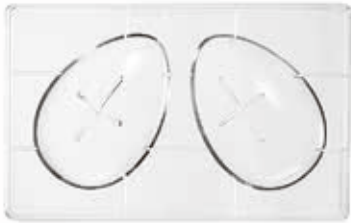

PC

Half egg mold

Stampo mezzo uovo
Halbe Eierform
Moule demi oeuf
Molde medio huevo

| art. | dim. mm. | pcs/pz | gr. | € |
|----------|----------|--------|-----|-------|
| 47862-82 | 90x130 | 2 | 150 | 29,45 |
| 47862-83 | 104x150 | 2 | 230 | 29,45 |



PC

Half egg mold

Stampo mezzo uovo
Halbe Eierform
Moule demi oeuf
Molde medio huevo

| art. | dim. mm. | pcs/pz | gr. | € |
|----------|----------|--------|-----|-------|
| 47862-84 | 121x175 | 1 | 260 | 29,45 |
| 47862-85 | 141x204 | 1 | 380 | 29,45 |
| 47862-86 | 157x227 | 1 | 430 | 29,45 |



PE

Egg mold, PET

Stampo uovo
Ostereierform
Moule à oeuf
Molde para huevos

| art. | dim. mm. | pcs/pz | € |
|----------|------------|--------|-------|
| 47865-44 | 220x160x85 | 1 | 9,55 |
| 47865-23 | 110x80x40 | 2 | 9,55 |
| 47865-80 | 112x83x44 | 2 | 12,16 |
| 47865-81 | 125x94x44 | 2 | 9,55 |
| 47865-82 | 140x100x50 | 2 | 9,55 |
| 47865-83 | 154x110x55 | 2 | 9,55 |



PE

Egg mold, PET

Stampo uovo
Ostereierform
Moule à oeuf
Molde para huevos

| art. | dim. mm. | pcs/pz | € |
|----------|----------|--------|-------|
| 47865-66 | 80x60x25 | 4 | 9,55 |
| 47865-73 | 40x31x17 | 14 | 11,36 |
| 47865-71 | 36x23x12 | 18 | - |



PE

Egg mold, PET

Stampo uovo
Ostereierform
Moule à oeuf
Molde para huevos

| art. | dim. mm. | pcs/pz | € |
|----------|----------|--------|---|
| 47865-74 | 64x44x26 | 6 | - |
| 47865-72 | 39x25x13 | 14 | - |



PE

Egg mold, PET

Stampo uovo
Ostereierform
Moule à oeuf
Molde para huevos

| art. | dim. mm. | pcs/pz | € |
|----------|------------|--------|-------|
| 47865-77 | 140x100x49 | 1 | 13,77 |
| 47865-76 | 95x70x40 | 2 | - |
| 47865-75 | 83x54x24 | 4 | - |

MAGNETIC MOLDS - STAMPI MAGNETICI

NEW PC

Thematic polycarbonate molds - mm 275x175 - with magnets to join the two halves and produce 3D chocolate subjects.

Stampi tematici in polycarbonato - mm 275x175 - con calamite per unire le due metà e realizzare soggetti 3D in cioccolato.



Egg/Uovo

| art. | Ø mm. | h. | pcs/pz | gr. | € |
|----------|-------|-----|--------|-----|-------|
| 47863-10 | 104 | 150 | 2 | 230 | 67,23 |
| 47863-11 | 120 | 175 | 1 | 260 | 67,23 |
| 47863-12 | 141 | 204 | 1 | 380 | 67,23 |
| 47863-13 | 160 | 230 | 1 | 430 | 67,23 |



Tree/Albero

| art. | Ø mm. | h. | pcs/pz | gr. | € |
|----------|-------|-----|--------|-----|-------|
| 47863-14 | 110 | 152 | 2 | 200 | 77,28 |



Tree/Albero

| art. | Ø mm. | h. | pcs/pz | gr. | € |
|----------|-------|-----|--------|-----|---|
| 47863-25 | 58 | 100 | 5 | 100 | - |



Reindeer/Renna

| art. | dim. mm. | pcs/pz | gr. | € |
|----------|-----------|--------|-----|-------|
| 47863-16 | 88x56x120 | 2 | 70 | 77,28 |



Reindeer/Renna

| art. | dim. mm. | pcs/pz | gr. | € |
|----------|-----------|--------|-----|---|
| 47863-23 | 46x45x100 | 4 | 68 | - |



Reindeer/Renna

| art. | dim. mm. | pcs/pz | gr. | € |
|----------|-----------|--------|-----|-------|
| 47863-24 | 43x43x120 | 4 | 65 | 67,23 |



Rooster/Gallo

| art. | dim. mm. | pcs/pz | gr. | € |
|----------|-------------|--------|-----|-------|
| 47863-20 | 100x160x126 | 2 | 115 | 67,23 |



Hen/Gallina

| art. | dim. mm. | pcs/pz | gr. | € |
|----------|------------|--------|-----|---|
| 47863-21 | 94x108x106 | 4 | 75 | - |



Chick/Pulcino

| art. | dim. mm. | pcs/pz | gr. | € |
|----------|----------|--------|-----|---|
| 47863-22 | 65x84x80 | 6 | 45 | - |



Ball/Palla

| art. | Ø mm. | h. | pcs/pz | gr. | € |
|----------|-------|----|--------|-----|-------|
| 47863-17 | 62 | 72 | 6 | 50 | 77,28 |



Soldier/Soldato

| art. | dim. mm. | pcs/pz | gr. | € |
|----------|-----------|--------|-----|-------|
| 47863-15 | 53x44x120 | 4 | 35 | 77,28 |



Santa Claus/Snowman

| art. | dim. mm. | h. | pcs/pz | € |
|----------|----------|----|--------|-------|
| 47863-26 | 46 | 79 | 4 | 67,23 |
| | 42x16 | 72 | 4 | |



3D HOLLOW MOLDS/STAMPI 3D CORPO CAVO - PETG
3D-HOHLFORME/MOULES CREUSES 3D/MOLDE 3D



Easter/Pasqua

| art. | h. mm. | € |
|----------|--------|-------|
| 47793-12 | 180 | 50,25 |



Easter/Pasqua

| art. | h. mm. | € |
|----------|--------|-------|
| 47793-13 | 140 | 50,25 |



Easter/Pasqua

| art. | h. mm. | # | € |
|----------|--------|---|-------|
| 47793-15 | 170 | 2 | 50,25 |



Easter/Pasqua

| art. | h. mm. | # | € |
|----------|--------|---|---|
| 47793-23 | 110 | 3 | - |



Christmas/Natale

| art. | h. mm. | € |
|----------|--------|-------|
| 47793-33 | 180 | 50,25 |



Christmas/Natale

| art. | h. mm. | € |
|----------|--------|-------|
| 47793-40 | 168 | 50,25 |



Easter/Pasqua

| art. | h. mm. | € |
|----------|--------|---|
| 47793-26 | 110 | - |



Christmas/Natale

| art. | h. mm. | # | € |
|----------|--------|---|-------|
| 47793-43 | 114 | 3 | 42,41 |



Christmas/Natale

| art. | h. mm. | € |
|----------|--------|-------|
| 47793-45 | 135 | 50,25 |



Ball/Pallone

| art. | h. mm. | € |
|----------|--------|-------|
| 47793-52 | 120 | 50,25 |



Shoe/Scarpa

| art. | dim. mm. | € |
|----------|------------|-------|
| 47793-55 | 220x75x170 | 50,25 |



FRUITS/TUTTIFRUTTI CM 40X30

Silicone molds cm 40x30, to create original dessert and surprising monoportions.

Stampi in silicone cm 40x30, per realizzare dessert al piatto e monoportzioni.



Pear

Pera

| art. | Ø mm. | h. | ml. | pcs/pz | € |
|----------|-------|----|-----|--------|-------|
| 47745-06 | 53 | 70 | 90 | 20 | 81,20 |

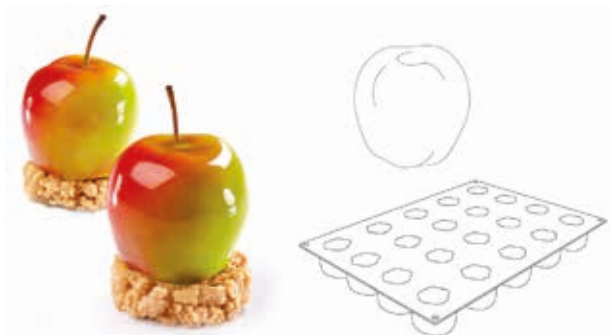

Apple

Mela

| art. | Ø mm. | h. | ml. | pcs/pz | € |
|----------|-------|----|-----|--------|-------|
| 47745-07 | 55 | 48 | 90 | 20 | 81,20 |



Peach/Cherry

Pesca/Ciliegia

| art. | dim. mm. | ml. | pcs/pz | € |
|----------|----------|-----|--------|-------|
| 47745-08 | 58x53x46 | 90 | 20 | 81,20 |

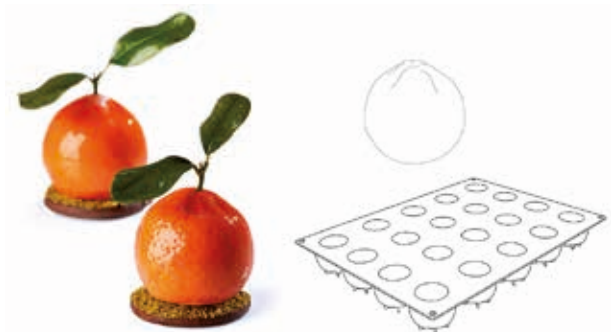

Tangerine

Mandarino

| art. | Ø mm. | h. | ml. | pcs/pz | € |
|----------|-------|----|-----|--------|-------|
| 47745-09 | 57 | 50 | 90 | 20 | 81,20 |

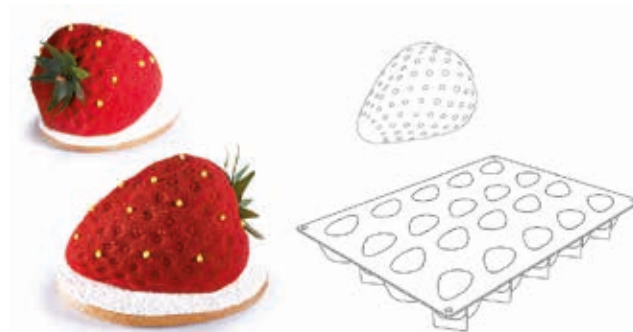

Strawberry

Fragola

| art. | dim. mm. | ml. | pcs/pz | € |
|----------|----------|-----|--------|-------|
| 47745-10 | 71x54x46 | 90 | 20 | 81,20 |



SILICONE MOLDS CM 60X40 - CM 40X30
STAMPI SILICONE CM 60X40 - CM 40X30



Quenelle 60x40

| art. | dim. mm. | ml. | pcs/pz | € |
|----------|----------|-----|--------|-------|
| 47746-01 | 66x33x30 | 32 | 49 | 81,91 |



Mini quenelle 60x40

| art. | dim. mm. | ml. | pcs/pz | € |
|----------|----------|-----|--------|-------|
| 47746-02 | 42x20x20 | 8 | 100 | 81,91 |

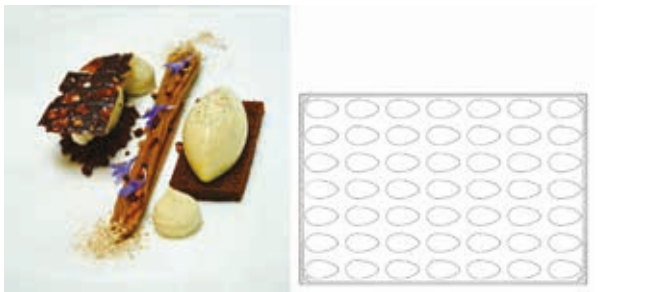

Quenelle 60x40

| art. | dim. mm. | ml. | pcs/pz | € |
|----------|----------|-----|--------|-------|
| 47746-03 | 66x35x26 | 34 | 49 | 81,91 |



Mini quenelle 60x40

| art. | dim. mm. | ml. | pcs/pz | € |
|----------|----------|-----|--------|-------|
| 47746-04 | 42x22x17 | 9 | 100 | 81,91 |



Sphere 40x30

| art. | Ø mm. | ml. | pcs/pz | € |
|----------|-------|-----|--------|-------|
| 47745-02 | 20 | 4 | 48 | 51,46 |



Sphere 40x30

| art. | Ø mm. | ml. | pcs/pz | € |
|----------|-------|-----|--------|-------|
| 47745-03 | 30 | 14 | 30 | 51,46 |



Sphere 40x30

| art. | Ø mm. | ml. | pcs/pz | € |
|----------|-------|-----|--------|-------|
| 47745-04 | 40 | 33 | 24 | 51,46 |



Sphere 40x30

| art. | Ø mm. | ml. | pcs/pz | € |
|----------|-------|-----|--------|-------|
| 47745-05 | 50 | 65 | 20 | 51,46 |

SILICONE MOLDS CM 17,5X30
STAMPI SILICONE CM 17,5X30



100% platinum silicone cake molds, cm 17,5x30 - GN 1/3.
Suitable for freezing and baking (resistance from -40°C up to +280°C). For a correct use, put the moulds on grills or perforated trays, in order to improve the heat diffusion during baking. High non-stick properties to let a perfect demoulding of the product. Can be washed by hand or in dishwasher. Manufactured in conformity with international regulations concerning food contact: D.M. no. 104 of 21/03/1973 (Italian law) - Arrêté du 25/11/1992 (French law) - BGVV (German law) - FDA (USA law).

Stampi in silicone platinico 100%, cm 17,5x30 - GN 1/3.
 Adatti per la surgelazione e la cottura (resistono da -40°C a +280°C). Per un utilizzo ottimale, posizionare gli stampi su griglie o teglie forate per favorire la diffusione del calore durante la cottura. Elevata antiaderenza per consentire una perfetta sfornatura del prodotto. Lavabili a mano e in lavastoviglie. Conforme alle norme internazionali che regolano l'utilizzo di materiali destinati al contatto con sostanze alimentari: D.M. n. 104 del 21/03/1973 (legislazione italiana) - Arrêté du 25/11/1992 (legislazione francese) - BGVV (legislazione tedesca) - FDA (legislazione statunitense).



Big baba
 Babà grande

| art. | Ø mm. | h. | ml. | pcs/pz | € |
|----------|-------|----|-----|--------|------|
| 47742-02 | 55 | 60 | 97 | 8 | 9,95 |



Medium baba
 Babà medio

| art. | Ø mm. | h. | ml. | pcs/pz | € |
|----------|-------|----|-----|--------|------|
| 47742-30 | 45 | 48 | 51 | 11 | 9,95 |



Small baba
 Babà piccolo

| art. | Ø mm. | h. | ml. | pcs/pz | € |
|----------|-------|----|-----|--------|------|
| 47742-31 | 35 | 38 | 25 | 15 | 9,95 |



Bavarian
 Bavarese

| art. | Ø mm. | h. | ml. | pcs/pz | € |
|----------|-------|----|-----|--------|------|
| 47742-41 | 57 | 57 | 110 | 8 | 9,95 |



Fluted cake
 Briochette cannellata

| art. | Ø mm. | h. | ml. | pcs/pz | € |
|----------|-------|----|-----|--------|------|
| 47742-12 | 79 | 30 | 109 | 6 | 9,95 |



Fluted cake
 Briochette cannellata

| art. | Ø mm. | h. | ml. | pcs/pz | € |
|----------|-------|----|-----|--------|------|
| 47742-27 | 79 | 37 | 100 | 6 | 9,95 |



Cake

Cake

| art. | dim. mm. | ml. | pcs/pz | € |
|----------|----------|-----|--------|------|
| 47742-56 | 80x30x30 | 62 | 9 | 9,95 |



Cannelle

Cannelle

| art. | Ø mm. | h. | ml. | pcs/pz | € |
|----------|-------|----|-----|--------|------|
| 47742-51 | 56 | 50 | 70 | 8 | 9,95 |



Cylinder

Cilindro

| art. | Ø mm. | h. | ml. | pcs/pz | € |
|----------|-------|----|-----|--------|------|
| 47742-17 | 60 | 35 | 89 | 8 | 9,95 |



Heart

Cuore

| art. | dim. mm. | ml. | pcs/pz | € |
|----------|----------|-----|--------|------|
| 47742-25 | 65x60x35 | 97 | 8 | 9,95 |



Biscuit disc

Disco biscuit

| art. | Ø mm. | h. | ml. | pcs/pz | € |
|----------|-------|----|-----|--------|------|
| 47742-23 | 103 | 20 | 160 | 3 | 9,95 |



Florentine

Florentine

| art. | Ø mm. | h. | ml. | pcs/pz | € |
|----------|-------|----|-----|--------|------|
| 47742-19 | 60 | 12 | 27 | 8 | 9,95 |



Madeleine

Madeleine

| art. | dim. mm. | ml. | pcs/pz | € |
|----------|------------|-----|--------|------|
| 47742-21 | 68x45x18 | 30 | 9 | 9,95 |
| 47742-37 | 42x30x11,5 | 8 | 20 | 9,95 |



Mini cannelle

Mini cannelle

| art. | Ø mm. | h. | ml. | pcs/pz | € |
|----------|-------|----|-----|--------|------|
| 47742-42 | 35 | 35 | 24 | 18 | 9,95 |



Mini financier

Mini finanziere

| art. | dim. mm. | ml. | pcs/pz | € |
|----------|----------|-----|--------|------|
| 47742-14 | 49x26x11 | 11 | 20 | 9,95 |



Mini gughupf

Mini gughupf

| art. | Ø mm. | h. | ml. | pcs/pz | € |
|----------|-------|----|-----|--------|------|
| 47742-34 | 60 | 33 | 70 | 6 | 9,95 |



Mini muffin

Mini muffin

| art. | Ø mm. | h. | ml. | pcs/pz | € |
|----------|-------|----|-----|--------|------|
| 47742-20 | 50 | 28 | 43 | 11 | 9,95 |



Mini oval

Mini ovale

| art. | dim. mm. | ml. | pcs/pz | € |
|----------|----------|-----|--------|------|
| 47742-09 | 53x33x20 | 28 | 16 | 9,95 |



Mini pyramid

Mini piramide

| art. | dim. mm. | ml. | pcs/pz | € |
|----------|----------|-----|--------|------|
| 47742-13 | 36x36x22 | 13 | 15 | 9,95 |



Mini savarin
Mini savarin

| art. | Ø mm. | h. | ml. | pcs/pz | € |
|----------|-------|----|-----|--------|------|
| 47742-05 | 41 | 12 | 12 | 18 | 9,95 |



Muffin
Muffin

| art. | Ø mm. | h. | ml. | pcs/pz | € |
|----------|-------|----|-----|--------|------|
| 47742-08 | 70 | 40 | 130 | 6 | 9,95 |



Muffin
Muffin

| art. | Ø mm. | h. | ml. | pcs/pz | € |
|----------|-------|----|-----|--------|------|
| 47742-33 | 80 | 35 | 110 | 5 | 9,95 |



Petit four
Petit four

| art. | Ø mm. | h. | ml. | pcs/pz | € |
|----------|-------|----|-----|--------|------|
| 47742-24 | 40 | 20 | 22 | 15 | 9,95 |



Pyramid
Piramide

| art. | dim. mm. | ml. | pcs/pz | € |
|----------|----------|-----|--------|------|
| 47742-07 | 71x71x40 | 92 | 6 | 9,95 |



Pomponette
Pomponette

| art. | Ø mm. | h. | ml. | pcs/pz | € |
|----------|-------|----|-----|--------|------|
| 47742-06 | 34 | 16 | 13 | 24 | 9,95 |



Savarin
Savarin

| art. | Ø mm. | h. | ml. | pcs/pz | € |
|----------|-------|----|-----|--------|------|
| 47742-15 | 72 | 23 | 67 | 6 | 9,95 |



Savarin
Savarin

| art. | Ø mm. | h. | ml. | pcs/pz | € |
|----------|-------|----|-----|--------|------|
| 47742-10 | 65 | 21 | 49 | 8 | 9,95 |



Half sphere
Semisfera

| art. | Ø mm. | h. | ml. | pcs/pz | € |
|----------|-------|----|-----|--------|------|
| 47742-04 | 30 | 17 | 8,5 | 24 | 9,95 |



Half sphere
Semisfera

| art. | Ø mm. | h. | ml. | pcs/pz | € |
|----------|-------|----|-----|--------|------|
| 47742-03 | 40 | 20 | 17 | 15 | 9,95 |



Half sphere
Semisfera

| art. | Ø mm. | h. | ml. | pcs/pz | € |
|----------|-------|----|-----|--------|------|
| 47742-48 | 50 | 23 | 33 | 15 | 9,95 |



Half sphere
Semisfera

| art. | Ø mm. | h. | ml. | pcs/pz | € |
|----------|-------|----|-----|--------|------|
| 47742-47 | 60 | 30 | 57 | 8 | 9,95 |



Half sphere
Semisfera

| art. | Ø mm. | h. | ml. | pcs/pz | € |
|----------|-------|----|-----|--------|------|
| 47742-01 | 70 | 35 | 89 | 6 | 9,95 |



Half sphere
Semisfera

| art. | Ø mm. | h. | ml. | pcs/pz | € |
|----------|-------|----|-----|--------|------|
| 47742-29 | 80 | 40 | 134 | 5 | 9,95 |

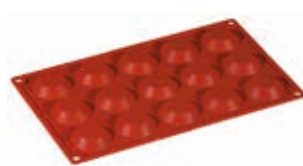

Tartlet
Tartelletta

| art. | Ø mm. | h. | ml. | pcs/pz | € |
|----------|-------|----|-----|--------|------|
| 47742-16 | 50 | 15 | 20 | 15 | 9,95 |



Cakes
Tortine

| art. | Ø mm. | h. | ml. | pcs/pz | € |
|----------|-------|----|-----|--------|------|
| 47742-61 | 80 | 18 | 85 | 6 | 9,95 |



Round cake tin
Tortiera tonda

| art. | Ø mm. | h. | ml. | € |
|----------|-------|----|------|-------|
| 47765-24 | 240 | 42 | 1850 | 11,86 |
| 47765-26 | 260 | 45 | 2250 | 11,96 |
| 47765-28 | 280 | 45 | 2600 | 11,96 |



Fluted round cake tin
Tortiera tonda cannellata

| art. | Ø mm. | h. | ml. | € |
|----------|-------|----|------|-------|
| 47766-26 | 260 | 30 | 1350 | 11,86 |
| 47766-28 | 280 | 30 | 1600 | 11,86 |
| 47766-30 | 300 | 30 | 1850 | 11,86 |





Tart tin

Crostata

| art. | Ø mm. | h. | ml. | € |
|----------|-------|----|------|-------|
| 47771-28 | 280 | 30 | 1700 | 11,86 |



Heart cake tin

Tortiera cuore

| art. | dim. mm. | ml. | € |
|----------|------------|------|-------|
| 47770-21 | 220x218x35 | 1150 | 11,96 |



Plumcake

Plumcake

| art. | dim. mm. | ml. | € |
|----------|------------|------|-------|
| 47773-24 | 240x105x65 | 1385 | 11,96 |
| 47773-28 | 280x105x65 | 1660 | 11,96 |



Rectangular cake pan

Tortiera rettangolare

| art. | dim. mm. | ml. | € |
|----------|------------|------|-------|
| 47769-28 | 280x240x40 | 2670 | 11,96 |



Drainer

Sgocciolatore

| art. | dim. cm. | € |
|----------|------------|-------|
| 47742-00 | 30x30x17,5 | 51,05 |

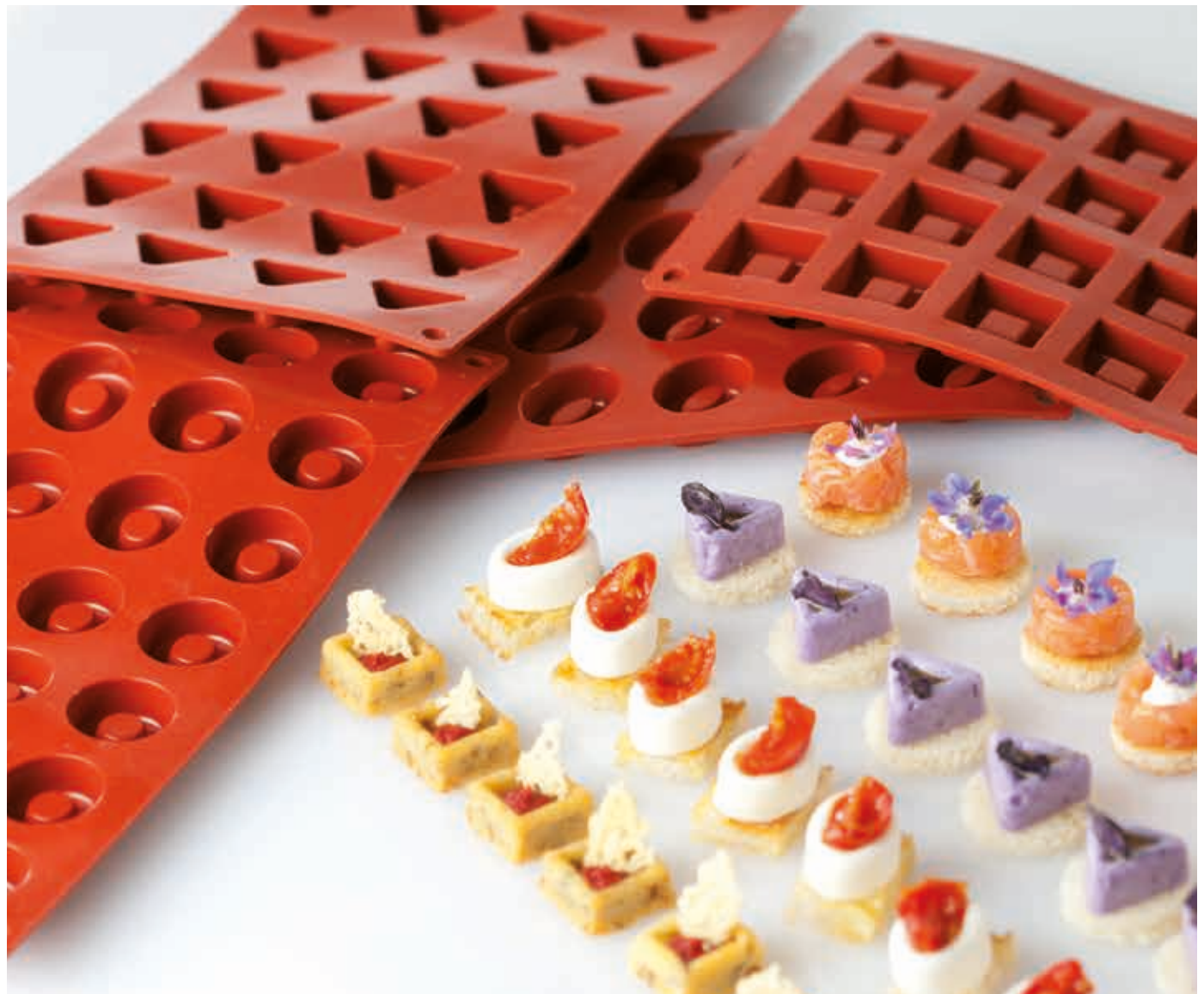
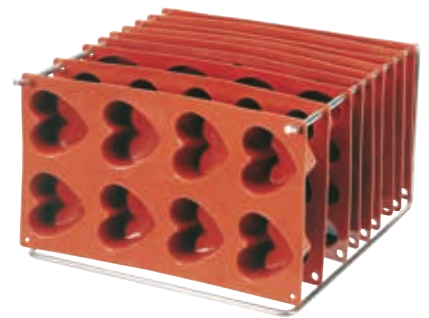

FLEXIPAN® ORIGINE

f FLEXIPAN®

PASTRY
PASTICCERIA



The Sasa Demarle Group is the only company in the world to formulate and produce its own food silicone, specially designed for the bakery and pastry industry. The use of this silicone allows an optimal heat distribution, which offers an even baking and colour, as well as perfect non-stick properties for an easy and perfect demoulding. The Flexipan moulds offer great performances with high lifetime expectancy: from 3,000 to 5,000+ baking cycles, depending on the conditions of use. Can be used for cooking and freezing (from -40°C to +240°C), for sweet and/or savory recipes. No need to grease, can be easily cleaned with water.

Il gruppo Sasa Demarle è l'unica azienda al mondo a formulare e produrre il proprio silicone alimentare, appositamente progettato per l'industria della panificazione e della pasticceria. L'uso di questo silicone consente una distribuzione ottimale del calore, offrendo una cottura e un colore uniformi, nonché proprietà antiaderenti perfette per una facile e perfetta sformatura. Gli stampi Flexipan offrono grandi prestazioni con un'elevata aspettativa di vita: da 3.000 a 5.000 e più cicli di cottura, a seconda delle condizioni di utilizzo. Può essere utilizzato per cucinare e congelare (da -40°C a +240°C), per ricette dolci e/o salate. Non serve ungere gli stampi e si pulisce facilmente con acqua.





Bavarois

Pcs/pz 18 - ml. 100

| art. | Ø mm. | h. | € |
|----------|-------|----|--------|
| 47740105 | 78 | 35 | 192,06 |



Champagne biscuits

Pcs/pz 45 - ml. 20

| art. | mm. | € |
|----------|-----------|--------|
| 47740-29 | 109x24x10 | 192,06 |



Charlotte

Pcs/pz 24 - ml. 60

| art. | Ø mm. | h. | € |
|----------|-------|----|--------|
| 47740-80 | 62 | 35 | 192,06 |



Charlotte

Pcs/pz 18 - ml. 100

| art. | Ø mm. | h. | € |
|----------|-------|----|--------|
| 47740-23 | 78 | 40 | 192,06 |



Chocolate bars

Pcs/pz 18 - ml. 100

| art. | mm. | € |
|----------|----------|--------|
| 47740128 | 78x58x40 | 192,06 |

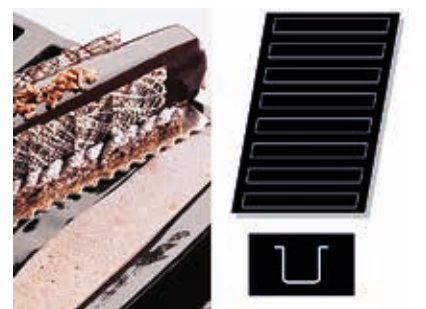

Christmas log

Pcs/pz 8 - ml. 450

| art. | mm. | € |
|----------|-----------|--------|
| 47740-28 | 339x40x39 | 192,06 |



Christmas log

Pcs/pz 24 - ml. 80

| art. | mm. | € |
|----------|----------|--------|
| 47740-26 | 95x40x30 | 192,06 |



Christmas log

Pcs/pz 24 - ml. 115

| art. | mm. | € |
|----------|-----------|--------|
| 47740-27 | 122x42x32 | 192,06 |



Christmas log insert

Pcs/pz 5 - ml. 700

| art. | mm. | € |
|----------|-----------|--------|
| 47740-93 | 495x40x39 | 299,29 |

With s/s frame. – Con supporto inox.



Cylinders

Pcs/pz 24 - ml. 65

| art. | Ø mm. | h. | € |
|----------|-------|----|--------|
| 47740-52 | 63/55 | 25 | 192,06 |
| 47740-06 | 63/55 | 35 | 192,06 |



Cylinders

Pcs/pz 15 - ml. 220

| art. | Ø mm. | h. | € |
|----------|-------|----|--------|
| 47740-69 | 82 | 50 | 192,06 |
| 47740-70 | 91 | 35 | 192,06 |



Cone insert

Pcs/pz 40 - ml. 24

| art. | Ø mm. | h. | € |
|----------|-------|----|--------|
| 47740102 | 50 | 40 | 192,06 |

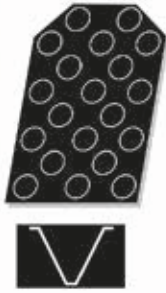

Cones

Pcs/pz 20 - ml. 80

| art. | Ø mm. | h. | € |
|----------|-------|----|--------|
| 47740103 | 70 | 60 | 192,06 |



Cookies

Pcs/pz 40 - ml. 30

| art. | Ø mm. | h. | € |
|----------|-------|----|--------|
| 47740-18 | 59/48 | 13 | 192,06 |
| 47740-60 | 78 | 10 | 192,06 |



Cookies

Pcs/pz 12 - ml. 245

| art. | Ø mm. | h. | € |
|----------|-------|----|--------|
| 47740-74 | 100 | 35 | 192,06 |
| 47740-75 | 105 | 40 | 192,06 |



Eggs

Pcs/pz 25 - ml. 95

| art. | mm. | € |
|----------|----------|--------|
| 47740135 | 94x60x31 | 192,06 |

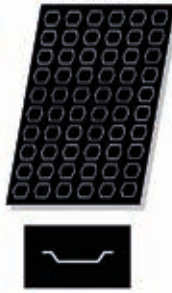

Exagon

Pcs/pz 60 - ml. 12

| art. | mm. | € |
|----------|----------|--------|
| 47740-83 | 45x40x12 | 192,06 |



Financiers

Pcs/pz 24 - ml. 45

| art. | mm. | € |
|----------|----------|--------|
| 47740-10 | 86x46x14 | 192,06 |



Flan bases

Pcs/pz 24 - ml. 70

| art. | Ø mm. | h. | € |
|----------|-------|----|--------|
| 47740-43 | 80 | 20 | 192,06 |



Fluted brioche

Pcs/pz 24 - ml. 60

| art. | mm. | € |
|----------|----------|--------|
| 47740-57 | 62x49x26 | 192,06 |



Fluted brioche

Pcs/pz 24 - ml. 60

| art. | Ø mm. | h. | € |
|----------|-------|----|--------|
| 47740-58 | 68 | 25 | 192,06 |
| 47740-59 | 78 | 30 | 192,06 |
| 47740-16 | 81 | 37 | 192,06 |



Fluted cakes

Pcs/pz 16 - ml. 105

| art. | mm. | € |
|----------|-----------|--------|
| 47740-95 | 110x60x25 | 192,06 |



Fluted ingots

Pcs/pz 24 - ml. 90

| art. | mm. | € |
|----------|-----------|--------|
| 47740127 | 106x46x25 | 192,06 |



Fluted tartlets

Pcs/pz 24 - ml. 70

| art. | mm. | € |
|----------|----------|--------|
| 47740132 | 78x78x20 | 192,06 |



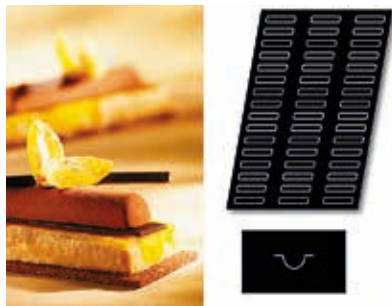

Half cylinder

Pcs/pz 48 - ml. 20

| art. | mm. | € |
|----------|----------|--------|
| 47740125 | 85x17x15 | 192,06 |

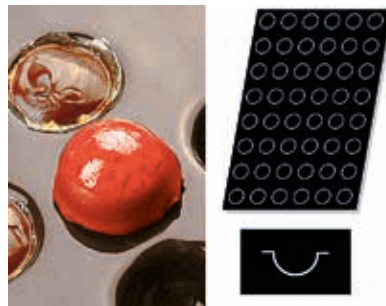

Half sphere

Pcs/pz 48 - ml. 20

| art. | Ø mm. | h. | € |
|----------|-------|----|--------|
| 47740-02 | 42 | 21 | 192,06 |



Half sphere

Pcs/pz 24 - ml. 125

| art. | Ø mm. | h. | € |
|----------|-------|----|--------|
| 47740-38 | 80 | 40 | 192,06 |



Half sphere

Pcs/pz 28 - ml. 50

| art. | Ø mm. | h. | € |
|----------|-------|----|--------|
| 47740-37 | 58 | 31 | 192,06 |



Half sphere

Pcs/pz 24 - ml. 105

| art. | Ø mm. | h. | € |
|----------|-------|----|--------|
| 47740-03 | 70 | 40 | 192,06 |



Hearts

Pcs/pz 20 - ml. 81

| art. | mm. | € |
|----------|----------|--------|
| 47740-89 | 75x65x35 | 192,06 |

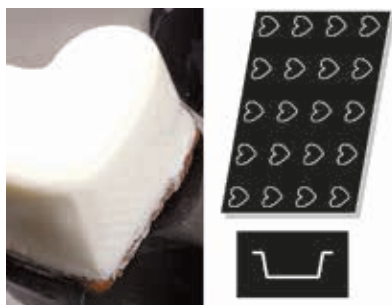

Hearts

Pcs/pz 20 - ml. 90

| art. | mm. | € |
|----------|----------|--------|
| 47740-41 | 66x62x35 | 192,06 |

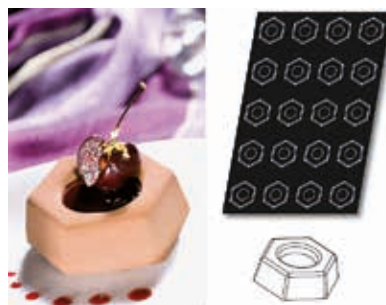

Hexagons

Pcs/pz 20 - ml. 90

| art. | Ø mm. | h. | € |
|----------|-------|----|--------|
| 47740130 | 80 | 25 | 192,06 |

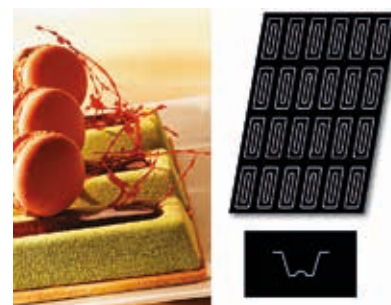

Hollow ingot

Pcs/pz 24 - ml. 70

| art. | mm. | € |
|----------|-----------|--------|
| 47740123 | 100x40x25 | 192,06 |
| 47740124 | 120x40x25 | 192,06 |

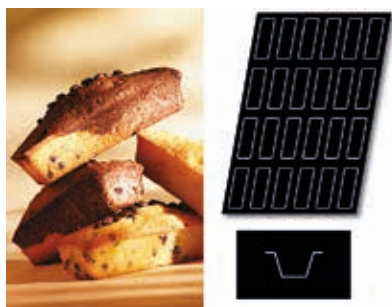

Ingot

Pcs/pz 24 - ml. 100

| art. | mm. | € |
|----------|-----------|--------|
| 47740122 | 120x40x25 | 192,06 |

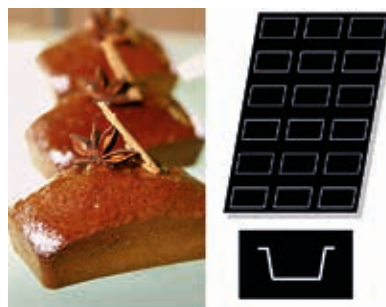

Ingot

Pcs/pz 18 - ml. 139

| art. | mm. | € |
|----------|-----------|--------|
| 47740-94 | 102x58x30 | 192,06 |



Interlacing hearts

Pcs/pz 8 - ml. 200

| art. | mm. | € |
|----------|------------|--------|
| 47740101 | 120x113x35 | 192,06 |



Landscapes

Pcs/pz 27 - ml. 80

| art. | Ø mm. | h. | € |
|----------|-------|----|--------|
| 47740144 | 75 | 24 | 192,06 |

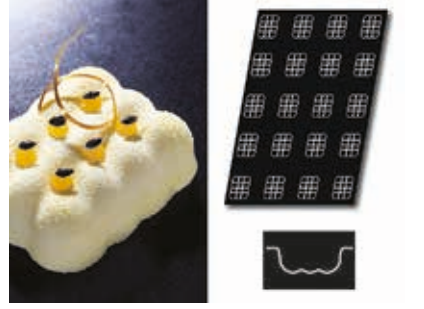

Little cushion

Pcs/pz 24 - ml. 70

| art. | mm. | € |
|----------|----------|--------|
| 47740-77 | 71x57x23 | 192,06 |

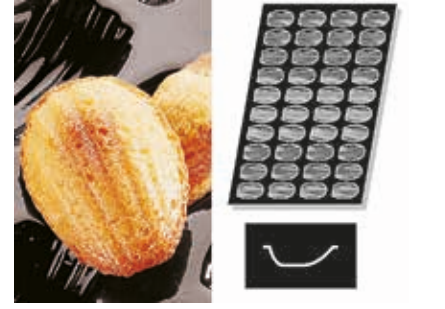

Madeines

Pcs/pz 40 - ml. 35

| art. | mm. | € |
|----------|----------|--------|
| 47740-17 | 78x47x19 | 192,06 |

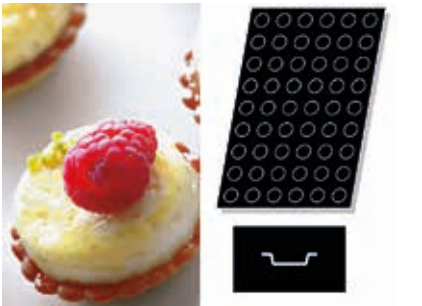

Medallions

Pcs/pz 54 - ml. 14

| art. | Ø mm. | h. | € |
|----------|-------|----|--------|
| 47740-50 | 38 | 10 | 192,06 |



Medallions

Pcs/pz 96 - ml. 5

| art. | Ø mm. | h. | € |
|----------|-------|----|--------|
| 47740-97 | 28 | 8 | 192,06 |



Mini Charlotte

Pcs/pz 60 - ml. 9

| art. | Ø mm. | h. | € |
|----------|-------|----|--------|
| 47740-82 | 35 | 15 | 192,06 |

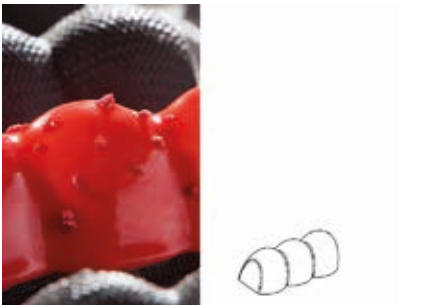

Mini chenilles

Pcs/pz 27 - ml. 10

| art. | mm. | € |
|----------|-----------|--------|
| 47740143 | 102x40x36 | 192,06 |



Mini drops

Pcs/pz 56 - ml. 18

| art. | mm. | € |
|----------|----------|--------|
| 47740133 | 52x32x20 | 192,06 |



Mini écriins

Pcs/pz 24 - ml. 65

| art. | mm. | € |
|----------|----------|--------|
| 47740142 | 50x50x29 | 192,06 |



Mini Madeines

Pcs/pz 56 - ml. 15

| art. | mm. | € |
|----------|----------|--------|
| 47740106 | 52x33x15 | 192,06 |



Mini St Honoré crown

Pcs/pz 18 - ml. 70

| art. | Ø mm. | h. | € |
|----------|-------|----|--------|
| 47740131 | 80 | 20 | 192,06 |



Muffins

Pcs/pz 24 - ml. 125

| art. | Ø mm. | h. | € |
|----------|-------|----|--------|
| 47740-19 | 73 | 40 | 192,06 |
| 47740-68 | 79 | 36 | 192,06 |





Optagon

Pcs/pz 40 - ml. 28

| art. | mm. | € |
|----------|----------|--------|
| 47740-34 | 43x40x26 | 192,06 |



Oval savarins

Pcs/pz 12 - ml. 230

| art. | mm. | € |
|----------|-----------|--------|
| 47740-81 | 100x80x45 | 192,06 |



Oval savarins

Pcs/pz 30 - ml. 48

| art. | mm. | € |
|----------|----------|--------|
| 47740111 | 70x50x22 | 192,06 |



Oval savarins

Pcs/pz 24 - ml. 70

| art. | mm. | € |
|----------|----------|--------|
| 47740-44 | 80x60x25 | 192,06 |



Oval tartlets

Pcs/pz 30 - ml. 35

| art. | mm. | € |
|----------|-----------|--------|
| 47740-32 | 106x45x15 | 192,06 |



Ovals

Pcs/pz 24 - ml. 80

| art. | mm. | € |
|----------|----------|--------|
| 47740-49 | 96x45x28 | 192,06 |



Ovals

Pcs/pz 30 - ml. 55

| art. | mm. | € |
|----------|----------|--------|
| 47740-46 | 70x50x25 | 192,06 |
| 47740-47 | 70x50x30 | 192,06 |



Ovals

Pcs/pz 20 - ml. 100

| art. | mm. | € |
|----------|----------|--------|
| 47740-48 | 85x60x30 | 192,06 |



Ovals

Pcs/pz 48 - ml. 15

| art. | mm. | € |
|----------|----------|--------|
| 47740-92 | 70x30x10 | 192,06 |



Ovals

Pcs/pz 24 - ml. 80

| art. | mm. | € |
|----------|-----------|--------|
| 47740-55 | 130x48x18 | 192,06 |



Pomponnettes

Pcs/pz 96 - ml. 14

| art. | Ø mm. | h. | € |
|----------|-------|----|--------|
| 47740-04 | 36 | 17 | 192,06 |



Puddings

Pcs/pz 15 - ml. 128

| art. | Ø mm. | h. | € |
|----------|-------|----|--------|
| 47740104 | 65 | 55 | 192,06 |

**PAstry PASTICCERIA
FLEXIPAN ORIGINE CM 60X40**



Pyramids

Pcs/pz 24 - ml. 90

| art. | mm. | € |
|----------|----------|--------|
| 47740-13 | 71x71x41 | 192,06 |

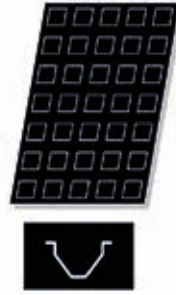

Pyramids flat bottom

Pcs/pz 35 - ml. 50

| art. | mm. | € |
|----------|----------|--------|
| 47740-39 | 50x50x35 | 192,06 |



Quiches

Pcs/pz 15 - ml. 135

| art. | Ø mm. | h. | € |
|----------|-------|----|--------|
| 47740-85 | 96 | 25 | 192,06 |



Quiches

Pcs/pz 24 - ml. 65

| art. | Ø mm. | h. | € |
|----------|-------|----|--------|
| 47740-30 | 77 | 20 | 192,06 |



Quiches

Pcs/pz 42 - ml. 30

| art. | mm. | € |
|----------|----------|--------|
| 47740-45 | 60x40x25 | 192,06 |



Quiches

Pcs/pz 15 - ml. 140

| art. | Ø mm. | h. | € |
|----------|-------|----|--------|
| 47740-62 | 102 | 20 | 192,06 |



Quiches

Pcs/pz 6 - ml. 200

| art. | Ø mm. | h. | € |
|----------|-------|----|--------|
| 47740-64 | 147 | 12 | 192,06 |
| 47740-65 | 150 | 15 | 192,06 |
| 47740-66 | 166 | 12 | 192,06 |

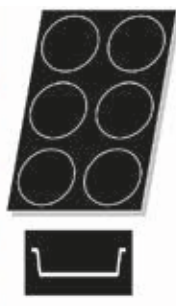

Quiches

Pcs/pz 6 - ml. 360

| art. | Ø mm. | h. | € |
|----------|-------|----|--------|
| 47740-71 | 140 | 25 | 192,06 |
| 47740-72 | 150 | 24 | 192,06 |
| 47740-05 | 186 | 12 | 192,06 |



Rectangular cakes

Pcs/pz 24 - ml. 55

| art. | mm. | € |
|----------|----------|--------|
| 47740-25 | 80x30x30 | 192,06 |



Rectangular cakes

Pcs/pz 25 - ml. 110

| art. | mm. | € |
|----------|----------|--------|
| 47740-24 | 89x46x25 | 192,06 |

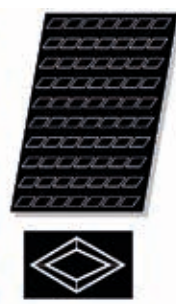

Rhombus

Pcs/pz 70 - ml. 9

| art. | mm. | € |
|----------|----------|--------|
| 47740-36 | 60x35x10 | 192,06 |



Round

Pcs/pz 11 - ml. 75

| art. | Ø mm. | h. | € |
|----------|-------|----|--------|
| 47740-63 | 125 | 16 | 192,06 |



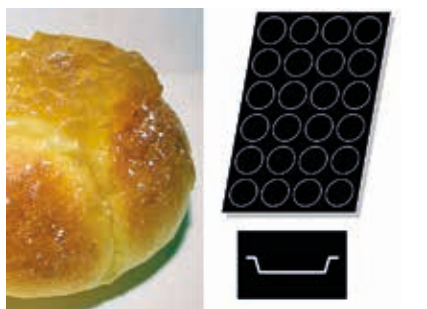

Round brioches
Pcs/pz 24 - ml. 65

| art. | Ø mm. | h. | € |
|----------|-------|----|--------|
| 47740-56 | 79 | 15 | 192,06 |



Savarin zaphire
Pcs/pz 24 - ml. 80

| art. | mm. | € |
|----------|----------|--------|
| 47740114 | 70x70x32 | 192,06 |



Savarins
Pcs/pz 35 - ml. 50

| art. | Ø mm. | h. | € |
|----------|-------|----|--------|
| 47740-20 | 66 | 20 | 192,06 |



Savarins
Pcs/pz 24 - ml. 65

| art. | Ø mm. | h. | € |
|----------|-------|----|--------|
| 47740-15 | 70 | 23 | 192,06 |



Scoop out
Pcs/pz 24 - ml. 90

| art. | mm. | € |
|----------|----------|--------|
| 47740145 | 85x61x30 | 192,06 |

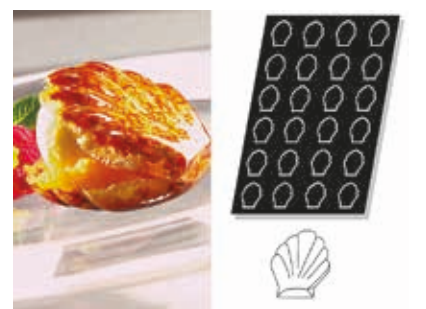

Shells
Pcs/pz 24 - ml. 70

| art. | mm. | € |
|----------|----------|--------|
| 47740-79 | 80x75x20 | 192,06 |

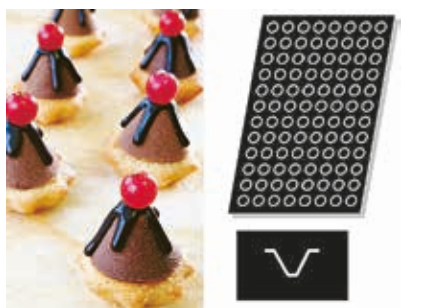

Small cones
Pcs/pz 96 - ml. 6

| art. | Ø mm. | h. | € |
|----------|-------|----|--------|
| 47740-99 | 30 | 20 | 192,06 |

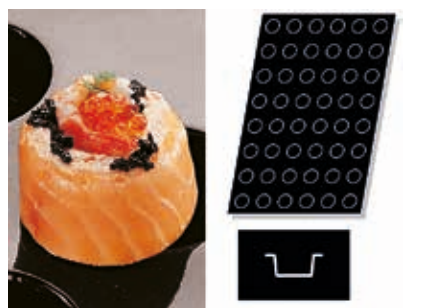

Small cylinders
Pcs/pz 48 - ml. 25

| art. | Ø mm. | h. | € |
|----------|-------|----|--------|
| 47740-51 | 40 | 20 | 192,06 |



Small financiers
Pcs/pz 84 - ml. 10

| art. | mm. | € |
|----------|----------|--------|
| 47740-09 | 50x26x11 | 192,06 |

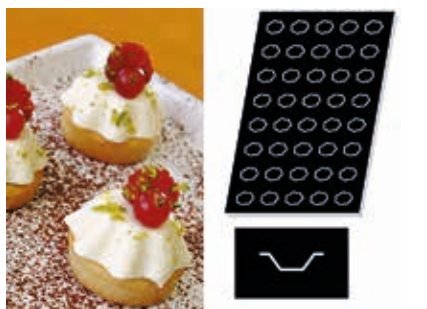

Small fluted tartlet
Pcs/pz 40 - ml. 11

| art. | mm. | € |
|----------|----------|--------|
| 47740100 | 46x38x15 | 192,06 |



Small half sphere
Pcs/pz 96 - ml. 6

| art. | Ø mm. | h. | € |
|----------|-------|----|--------|
| 47740-87 | 26 | 16 | 192,06 |

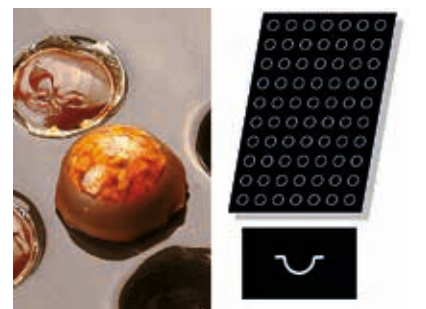

Small half sphere
Pcs/pz 70 - ml. 10

| art. | Ø mm. | h. | € |
|----------|-------|----|--------|
| 47740-01 | 29 | 18 | 192,06 |



Small hearts

Pcs/pz 70 - ml. 15

| art. | mm. | € |
|----------|----------|--------|
| 47740115 | 41x38x16 | 192,06 |



Small muffins

Pcs/pz 40 - ml. 45

| art. | Ø mm. | h. | € |
|----------|-------|----|--------|
| 47740-67 | 51 | 29 | 192,06 |



Small oval savarins

Pcs/pz 60 - ml. 9

| art. | mm. | € |
|----------|----------|--------|
| 47740-98 | 40x30x12 | 192,06 |



Small oval tartlets

Pcs/pz 48 - ml. 10

| art. | mm. | € |
|----------|----------|--------|
| 47740-31 | 66x27x11 | 192,06 |

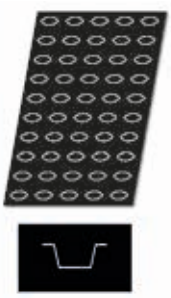

Small ovals

Pcs/pz 50 - ml. 20

| art. | mm. | € |
|----------|----------|--------|
| 47740-11 | 51x31x20 | 192,06 |



Small ovals flat bottom

Pcs/pz 64 - ml. 18

| art. | mm. | € |
|----------|----------|--------|
| 47740-91 | 57x35x12 | 192,06 |



Small pyramids

Pcs/pz 54 - ml. 15

| art. | mm. | € |
|----------|----------|--------|
| 47740-12 | 35x35x23 | 192,06 |

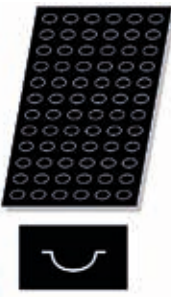

Small quenelles

Pcs/pz 72 - ml. 56

| art. | mm. | € |
|----------|----------|--------|
| 47740-90 | 42x26x20 | 192,06 |

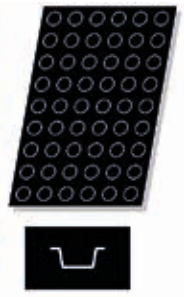

Small quiches

Pcs/pz 54 - ml. 22

| art. | Ø mm. | h. | € |
|----------|-------|----|--------|
| 47740-33 | 40 | 20 | 192,06 |



Small quiches

Pcs/pz 60 - ml. 13

| art. | Ø mm. | h. | € |
|----------|-------|----|--------|
| 47740-07 | 42 | 10 | 192,06 |



Small quiches

Pcs/pz 48 - ml. 20

| art. | Ø mm. | h. | € |
|----------|-------|----|--------|
| 47740-08 | 48 | 15 | 192,06 |



Small quiches

Pcs/pz 40 - ml. 35

| art. | Ø mm. | h. | € |
|----------|-------|----|--------|
| 47740-84 | 58 | 20 | 192,06 |





Small Savarin
Pcs/pz 60 - ml. 15

| art. | mm. | € |
|----------|----------|--------|
| 47740107 | 37x37x17 | 192,06 |



Small savarin
Pcs/pz 60 - ml. 10

| art. | Ø mm. | h. | € |
|----------|-------|----|--------|
| 47740-14 | 41 | 12 | 192,06 |



Small squares
Pcs/pz 60 - ml. 18

| art. | mm. | € |
|----------|----------|--------|
| 47740116 | 37x37x17 | 192,06 |



Small squares
Pcs/pz 60 - ml. 20

| art. | mm. | € |
|----------|----------|--------|
| 47740109 | 45x45x12 | 192,06 |



Small upside-down half sphere
Pcs/pz 45 - ml. 6

| art. | Ø mm. | h. | € |
|----------|-------|----|--------|
| 47740-86 | 26 | 16 | 192,06 |



Square Savarin
Pcs/pz 35 - ml. 45

| art. | mm. | € |
|----------|----------|--------|
| 47740108 | 56x56x24 | 192,06 |



Square Savarin
Pcs/pz 24 - ml. 100

| art. | mm. | € |
|----------|----------|--------|
| 47740-96 | 70x70x30 | 192,06 |

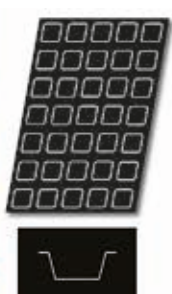

Squares
Pcs/pz 35 - ml. 60

| art. | mm. | € |
|----------|----------|--------|
| 47740117 | 56x56x24 | 192,06 |



Squares
Pcs/pz 40 - ml. 40

| art. | mm. | € |
|----------|----------|--------|
| 47740110 | 60x60x15 | 192,06 |



Stars
Pcs/pz 24 - ml. 35

| art. | mm. | € |
|----------|----------|---|
| 47740-88 | 80x65x15 | - |



Tarte tatin
Pcs/pz 15 - ml. 135

| art. | Ø mm. | h. | € |
|----------|-------|----|--------|
| 47740-73 | 82 | 30 | 192,06 |



Teddy bear
Pcs/pz 18 - ml. 80

| art. | mm. | € |
|----------|----------|--------|
| 47740-53 | 90x55x20 | 192,06 |



Triangles

Pcs/pz 80 - ml. 7

| art. | mm. | € |
|----------|----------|--------|
| 47740-35 | 48x41x10 | 192,06 |



Various petits-fours

Pcs/pz 60

| art. | h. mm. | € |
|----------|--------|--------|
| 47740134 | 22 | 192,06 |



Zaphire

Pcs/pz 54 - ml. 17

| art. | mm. | € |
|----------|----------|--------|
| 47740112 | 40x40x24 | 192,06 |



Zaphire

Pcs/pz 24 - ml. 75

| art. | mm. | € |
|----------|----------|--------|
| 47740113 | 70x70x35 | 192,06 |



Calisson

Pcs/pz 20 - ml. 118

| art. | mm. | € |
|----------|-----------|--------|
| 47743-03 | 180x90x50 | 192,06 |



Lemon

Pcs/pz 20 - ml. 73

| art. | mm. | € |
|----------|----------|--------|
| 47743-05 | 85x65x34 | 192,06 |



Donuts

Pcs/pz 8

| art. | Ø mm. | h. | € |
|----------|-------|----|--------|
| 47743-13 | 88 | 30 | 157,08 |



Triangles

Pcs/pz 24 - ml. 80

| art. | mm. | € |
|----------|----------|---|
| 47743-10 | 70x95x25 | - |



Small half sphere

Mm 400x300

Pcs/pz 5 - ml. 63

| art. | Ø mm. | h. | € |
|----------|-------|----|-------|
| 47741-76 | 23 | 11 | 99,29 |



Small hearts

Mm 400x300

Pcs/pz 30 - ml. 15

| art. | mm. | € |
|----------|----------|-------|
| 47741-78 | 52x49x10 | 99,29 |



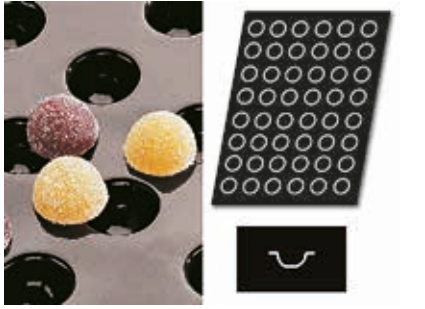

Half sphere flat
Mm 400x300
Pcs/pz 48 - ml. 10

| art. | Ø mm. | h. | € |
|----------|-------|----|-------|
| 47741-77 | 30 | 13 | 99,29 |



Twisted bars
Mm 400x300
Pcs/pz 12

| art. | mm. | € |
|----------|-----------|-------|
| 47741-07 | 100x45x25 | 99,29 |



Stripped rectangle
Mm 280x160
Pc/pz 1

| art. | mm. | € |
|----------|------------|-------|
| 47741-11 | 240x120x50 | 44,82 |



Stripped bars
Mm 400x300
Pcs/pz 16

| art. | mm. | € |
|----------|-----------|-------|
| 47741-13 | 100x30x15 | 99,29 |



Candy
Mm 400x300
Pcs/pz 12

| art. | mm. | € |
|----------|----------|-------|
| 47741-15 | 65x50x36 | 99,29 |



Fluted crowns
Mm 400x300
Pcs/pz 8

| art. | Ø mm. | h. | € |
|----------|-------|----|-------|
| 47741-20 | 80 | 26 | 99,29 |



FLEXIPAN® INSPIRATION

f FLEXIPAN®

PASTRY
PASTICCERIA



The FLEXIPAN® INSPIRATION range is the high-performance solution for both straight-edged and complex shapes. A new source of INSPIRATION for creations of both traditional shapes and special designs. Product advantages: 100% silicone, baking at + 240 °C and freezing at - 40 °C, designed for automated pan release, ideal for semi-industrial and industrial production, superior pan durability, easy pan release, precise, detailed shapes.

La gamma FLEXIPAN® INSPIRATION è la soluzione ad alte prestazioni per prodotti con bordi dritti e per le forme complesse. Una nuova fonte di ISPIRAZIONE per le creazioni sia con forme tradizionali o di design speciali. Vantaggi del prodotto: 100% silicone, cottura a +240°C e congelamento a -40°C, progettati per il rilascio automatico dello stampo, ideale per la produzione semi industriale e industriale, durata superiore dello stampo, facile sformatura, forme precise e dettagliate.





Twist
Mm 400x300
Pcs/pz 48

| art. | Ø mm. | h. | € |
|----------|-------|----|--------|
| 47741-00 | 32 | 20 | 132,66 |



Stars
Mm 400x300
Pcs/pz 48

| art. | Ø mm. | h. | € |
|----------|-------|----|-------|
| 47741-01 | 32 | 13 | 99,29 |



Insert fingers
Mm 400x300
Pcs/pz 18

| art. | mm. | € |
|----------|--------|-------|
| 47741-02 | 120x11 | 99,29 |



Sphere 3D
Mm 400x300
Pcs/pz 8

| art. | Ø mm. | h. | € |
|----------|-------|----|-------|
| 47741-05 | 65 | 50 | 95,78 |



Waffles
Mm 400x300
Pcs/pz 8 - ml. 100

| art. | mm. | € |
|----------|-----------|-------|
| 47741-38 | 80x127x15 | 99,29 |



Fingers
Mm 400x300
Pcs/pz 24 - ml. 54

| art. | mm. | € |
|----------|-----------|-------|
| 47741-37 | 129x28x15 | 99,29 |



Cylinder
Mm 600x400
Pcs/pz 24 - ml. 148

| art. | Ø mm. | h. | € |
|----------|-------|----|--------|
| 47744-30 | 70 | 40 | 160,20 |

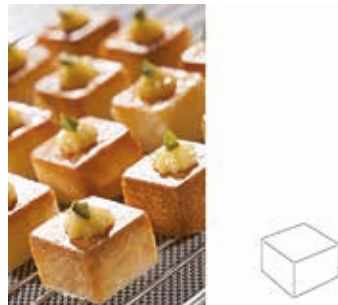

Cube
Mm 600x400
Pcs/pz 96 - ml. 17

| art. | mm. | € |
|----------|----------|--------|
| 47744-32 | 30x30x20 | 160,20 |



Kougloff
Mm 600x400
Pcs/pz 24 - ml. 150

| art. | Ø mm. | h. | € |
|----------|-------|----|--------|
| 47744-31 | 80 | 54 | 165,83 |



Diamond
Mm 600x400
Pcs/pz 24 - ml. 100

| art. | Ø mm. | h. | € |
|----------|-------|----|--------|
| 47744-34 | 79 | 40 | 160,20 |



Insert ring
Mm 600x400
Pcs/pz 24

| art. | Ø mm. | h. | € |
|----------|-------|----|--------|
| 47743-15 | 61 | 9 | 165,83 |



Ring 3D
Mm 600x400
Pcs/pz 24

| art. | Ø mm. | h. | € |
|----------|-------|----|--------|
| 47743-16 | 76 | 25 | 165,83 |



NEW

Flower buds
Mm 400x300
Pcs/pz 30

| art. | mm. | € |
|----------|----------|-------|
| 47744-04 | 45x45x21 | 76,18 |



NEW

Fluted rectangles
Mm 400x300
Pcs/pz 12

| art. | mm. | € |
|----------|----------|-------|
| 47744-05 | 65x54x22 | 76,18 |

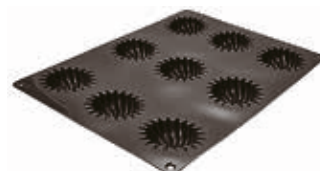

NEW

Saint-Honoré
Mm 400x300
Pcs/pz 9

| art. | Ø mm. | h. | € |
|----------|-------|----|-------|
| 47744-06 | 81 | 30 | 76,18 |



NEW

Cathedrals
Mm 400x300
Pcs/pz 14

| art. | mm. | € |
|----------|-----------|-------|
| 47744-07 | 103x34x48 | 76,18 |



Half sphere

| art. | Ø mm. | h. | ml. | € |
|----------|-------|----|------|-------|
| 47744-81 | 180 | 90 | 1600 | 95,78 |



NEW

Rond

| art. | Ø mm. | h. | € |
|----------|-------|----|-------|
| 47744-02 | 220 | 45 | 68,94 |



Flexiform desserts

| art. | mm. | ml. | € |
|----------|------------|-----|-------|
| 47744-58 | 253x253x45 | 222 | 95,78 |



Flexiform desserts

| art. | mm. | ml. | € |
|----------|------------|-----|--------|
| 47744-59 | 600x400x50 | 980 | 174,27 |



Silpat entremet

| art. | mm. | € |
|----------|------------|--------|
| 47744-48 | 280x480x13 | 95,78 |
| 47744-60 | 360x555x10 | 127,03 |
| 47744-62 | 360x555x20 | 127,03 |

3D DESIGNS FOR DESSERTS - DISCS & MATS



3D disc Rosace

| art. | Ø mm. | h. mm. | € |
|----------|-------|--------|-------|
| 47744-10 | 225 | 6 | 44,12 |



NEW

3D disc Dots

| art. | Ø mm. | h. mm. | € |
|----------|-------|--------|-------|
| 47744-01 | 216 | 8 | 33,17 |



NEW

3D disc Flower crown

| art. | Ø mm. | h. mm. | € |
|----------|-------|--------|-------|
| 47744-03 | 216 | 2 | 33,17 |



3D mat Venetian Cane

| art. | mm. | € |
|----------|---------|---|
| 47744-19 | 555x360 | - |



3D mat Labyrinth

| art. | mm. | € |
|----------|---------|--------|
| 47744-21 | 600x400 | 157,08 |



3D mat Bubbles

| art. | mm. | € |
|----------|---------|--------|
| 47744-36 | 600x400 | 157,08 |



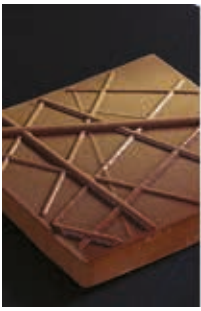

3D mat Mikado

| art. | mm. | € |
|----------|---------|--------|
| 47744-37 | 600x400 | 157,08 |



3D mat Buche2

| art. | mm. | € |
|----------|---------|-------|
| 47744-70 | 275x185 | 73,57 |



3D mat Buche1

| art. | mm. | € |
|----------|---------|-------|
| 47744-71 | 275x185 | 73,57 |



SILPAT® – SILPAIN® – ROUL'PAT®

SILPAT: Non-stick sheet ideal for backing brioches and buns as well as any kind of sweet bread backed in sheets. Ideal also for working sugar. **SILPAIN:** Non-stick perforated sheet ideal for baking bread and tarts. **ROUL'PAT:** The silicone coating on both sides prevents the sheet from slipping. Perfect to prepare any type of dough and it also enables to easily prepare macaroon.

SILPAT: Antiaderente ideale per la cottura di tutte le viennoiseries e tutti i tipi di pasticceria da panetteria cotti in teglie. Ideale anche per la lavorazione dello zucchero. SILPAIN: Antiaderente areato ideale per la cottura di pani e la cottura in bianco di fondi per crostate. ROUL'PAT: Con il rivestimento in silicone su entrambi i lati, non scivola sul piano di lavoro. Permette di lavorare ogni tipo di pasta, e con grande facilità anche il croccante.



SILPAT Silicone baking sheet

Tappeto silicone
Silikonbackmatte
Tapis cuisson en silicone
Tapete de cocción silicona

| art. | GN | mm. | € |
|----------|-----|---------|-------|
| 47680-40 | - | 400x300 | 23,72 |
| 47680-53 | 1/1 | 530x325 | 31,76 |
| 47680-60 | - | 600x400 | 44,12 |



SILPAIN Silicone baking sheet

Tappeto silicone
Silikonbackmatte
Tapis de cuisson en silicone
Tapete de cocción silicona

| art. | GN | mm. | € |
|----------|-----|---------|-------|
| 47685-53 | 1/1 | 530x325 | 35,18 |
| 47685-60 | - | 600x400 | 44,12 |



ROUL'PAT Silicone baking sheet

Tappeto silicone
Silikonbackmatte
Tapis de cuisson en silicone
Tapete de cocción silicona

| art. | mm. | € |
|----------|---------|-------|
| 47688-60 | 600x400 | 50,95 |



NEW

SILPAT Macarons

Tappeto silicone
Silikonbackmatte
Tapis de cuisson en silicone
Tapete de cocción silicona

| art. | Ø mm. | No. | mm. | € |
|----------|-------|-----|---------|-------|
| 47683-01 | 35 | 28 | 400x300 | 26,93 |
| 47683-02 | 35 | 63 | 600x400 | 49,04 |
| 47683-03 | 50 | 28 | 600x400 | 49,04 |



NEW

SILPAIN Éclair

Tappeto silicone
Silikonbackmatte
Tapis de cuisson en silicone
Tapete de cocción silicona

| art. | No. | mm. | € |
|----------|-----|---------|-------|
| 47685-61 | 18 | 600x400 | 73,57 |

FLEXIPAN® AIR



Flexible pans made of silicone and glass fiber fabric and bi-component, designed for bread-making and bakery products, especially for cream puffs dough. The pre-formed shapes make easy obtaining perfect, regular and same size products. Neither greasing the sheet nor spiking the dough is required before baking. The non-stick property of the material allows an easy and perfect extraction. They have a well-ventilated texture that ensures proper heat circulation, to obtain a crusty finished product with excellent color. Non-stick FLEXIPAN® AIR sheets are very durable, lasting up to 1500 cycles without any risk of sticking. For baking up to +240°, as well as for freezing at -40°, and are also designed to hold frozen dough. Using FLEXIPAN® AIR pans the products will be well calibrated and perfectly homogenous in terms of size, color and crust.

Stampi flessibili realizzati in silicone e tessuto in fibra di vetro e bicomponente, ideali per la panificazione e prodotti dolci da forno, in particolare per la pasta di bigné. Grazie alle impronte preformate, preparare prodotti uguali e regolari diventa facile. Non è più indispensabile spennellare con tuorlo o forare la pasta. Grazie alle sue proprietà antiaderenti l'estrazione è impeccabile. Hanno una texture ben ventilata che garantisce una corretta circolazione del calore, per ottenere un prodotto finito croccante e dal colore eccellente. Gli stampi FLEXIPAN® AIR sono molto resistenti, durano fino a 1500 cicli senza alcun rischio che il prodotto si attacchi. Per cotture fino a +240°, come pure per congelare a -40°, e sono progettati anche per contenere impasti surgelati. L'utilizzo di FLEXIPAN® AIR consente di ottenere prodotti ben calibrati e perfettamente omogenei per dimensione, colore e crosta.



Paris-Brest

Mm 600x400
Pcs/pz 24 - ml. 50

| art. | Ø mm. | h. | € |
|----------|-------|----|-------|
| 41760-27 | 80 | 15 | 99,29 |



Oval choux

Mm 600x400
Pcs/pz 25 - ml. 56

| art. | mm. | € |
|----------|----------|---|
| 41760-26 | 90x60x15 | - |



Baby choux

Mm 600x400
Pcs/pz 59 - ml. 4

| art. | Ø mm. | h. | € |
|----------|-------|----|-------|
| 41760-22 | 30 | 5 | 99,29 |



Big choux
Mm 600x400
Pcs/pz 28 - ml. 48

| art. | Ø mm. | h. | € |
|----------|-------|----|---|
| 41759-01 | 67 | 15 | - |



Eclairs - Right handed / Per ambidestri
Mm 600x400
Pcs/pz 18 - ml. 15

| art. | mm. | € |
|----------|----------|-------|
| 41760-20 | 125x25x5 | 99,29 |



Eclairs - Left handed / Per mancini
Mm 600x400
Pcs/pz 18 - ml. 15

| art. | mm. | € |
|----------|----------|-------|
| 41760-21 | 125x25x5 | 99,29 |



Round shapes / Forme rotonde
Mm 600x400
Pcs/pz 28 - ml. 48

| art. | Ø mm. | h. | € |
|----------|-------|----|-------|
| 41759-01 | 67 | 15 | 99,29 |



Round shapes / Forme rotonde
Mm 600x400
Pcs/pz 15 - ml. 140

| art. | Ø mm. | h. | € |
|----------|-------|----|-------|
| 41759-05 | 102 | 20 | 99,29 |



Round shapes / Forme rotonde
Mm 600x400
Pcs/pz 11 - ml. 175

| art. | Ø mm. | h. | € |
|----------|-------|----|-------|
| 41759-09 | 125 | 16 | 99,29 |





Oval shapes / Forme ovali

Mm 600x400

Pcs/pz 24 - ml. 80

| art. | mm. | h. | € |
|----------|-------|----|---|
| 41760-02 | 95x40 | 30 | - |



Oval shapes / Forme ovali

Mm 600x400

Pcs/pz 18 - ml. 50

| art. | mm. | h. | € |
|----------|--------|----|-------|
| 41760-05 | 155x41 | 25 | 99,29 |



Oval shapes / Forme ovali

Mm 600x400

Pcs/pz 12 - ml. 230

| art. | mm. | h. | € |
|----------|--------|----|-------|
| 41760-06 | 169x64 | 30 | 99,29 |



Oval shapes / Forme ovali

Mm 600x400

Pcs/pz 8 - ml. 400

| art. | mm. | h. | € |
|----------|--------|----|-------|
| 41760-08 | 259x64 | 30 | 99,29 |



Oval shapes / Forme ovali

Mm 600x400

Pcs/pz 6 - ml. 435

| art. | mm. | h. | € |
|----------|--------|----|-------|
| 41760-09 | 314x60 | 30 | 99,29 |



Square shapes / Forme quadrate

Mm 600x400

Pcs/pz 15 - ml. 200

| art. | mm. | € |
|----------|----------|-------|
| 41759-04 | 93x93x28 | 99,29 |

NEW



Sandwich

Mm 600x400

Pcs/pz 8 - ml. 500

| art. | mm. | € |
|----------|-----------|-------|
| 41759-07 | 240x70x35 | 99,29 |

NEW



Brioches

Mm 390x250

Pcs/pz 2

| art. | mm. | € |
|----------|------------|-------|
| 41759-08 | 211x158x32 | 66,03 |

NEW



French loaves perforated sheet, silicone coated

Teglia alluminio forato, siliconata

Pariserbrotblech, Silikon-beschichtet

Plaque perforée pain parisien, siliconée

Placa pan perforada, siliconada

| art. | cm. | pcs/pz | € |
|----------|-------|--------|-------|
| 41758-53 | 53x32 | 4 | 51,36 |
| 41758-60 | 60x40 | 5 | 60,60 |
| 41758-65 | 65x43 | 6 | 70,95 |
| 41758-85 | 85x43 | 6 | 85,32 |

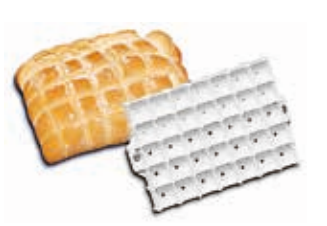

ABS

Bread mould

Stampo per pane

Brot-Ausstechforme

Découpoir à pain

Cortador para pan

| art. | cm. | € |
|----------|-------|-------|
| 47041-01 | 14x10 | 20,20 |



ABS

Bread mould

Stampo per pane

Brot-Ausstechforme

Découpoir à pain

Cortador para pan

| art. | cm. | € |
|----------|-------|-------|
| 47041-02 | 14x11 | 20,20 |



ABS

Bread mould

Stampo per pane

Brot-Ausstechforme

Découpoir à pain

Cortador para pan

| art. | Ø cm. | € |
|----------|-------|-------|
| 47041-05 | 12,5 | 20,20 |



ABS

Bread mould
Stampo per pane
Brot-Ausstechforme
Découpoir à pain
Cortador para pan

| art. | Ø cm. | € |
|----------|-------|---|
| 47041-07 | 8 | - |



Bread brush
Spazzola pane
Brot-Bürste
Brosse à pain
Cepillo para pan

| art. | l. cm. | € |
|----------|--------|-------|
| 42614-04 | 24,5 | 18,09 |
| 42614-05 | 32,0 | 27,34 |
| 42614-06 | 41,0 | 37,89 |
| 42614-07 | 46,0 | 39,50 |



SS

Disposable baker's blades
Lame panettiere usa e getta
Einweg-Bäcker-Klingen
Incisette boulanger jetables
Láminas del panadero desechables

| art. | l. cm. | pcs/pz | € |
|----------|--------|--------|-------|
| 48290-10 | 12 | 10 | 66,03 |



PE

Bread basket
Cesta pane
Brot-Korb
Corbeille à pain
Cesta pan

| art. | cm. | lt. | € |
|----------|----------|-----|-------|
| 44982-04 | 57x36x34 | 40 | 18,19 |
| 44982-06 | 66x45x35 | 60 | 21,91 |
| 44982-10 | 78x52x40 | 100 | 46,43 |



PP

Bread proofing basket
Cestino impasto
Gärkorb
Banneton
Molde para pan

| art. | Ø cm. | h. | gr. | col. | € |
|----------|-------|-----|------|------|-------|
| 47042-19 | 19 | 7,5 | 500 | ● | 17,09 |
| 47042-22 | 22 | 9,3 | 1000 | ● | 21,00 |
| 47042-25 | 25 | 9 | 1500 | ● | 21,11 |



PP

Bread proofing basket
Cestino impasto
Gärkorb
Banneton
Molde para pan

| art. | cm. | gr. | col. | € |
|----------|-----------|------|------|-------|
| 47043-27 | 27x12x6,5 | 500 | ● | 18,29 |
| 47043-35 | 35x13x7,2 | 1000 | ● | 21,00 |
| 47043-42 | 42x14x7,5 | 1500 | ● | 22,41 |



ETHNIC CUISINE CUCINA ETNICA

ASIA FUSION



The images of the products in this chapter reflect the characteristics of the products in the warehouse. However, they have to be considered mainly for illustrative purposes only. Although we make every effort to display the products accurately, the products received may vary slightly from those images. In any case the changes are intended as improvements and do not alter the function, nor lessen the utility of the product.

Tutte le foto degli articoli presenti nel capitolo rispecchiano il più possibile le caratteristiche dei prodotti presenti in magazzino. Teniamo comunque a precisare che le immagini sono indicative ed i prodotti reali potrebbero differire nei colori e nelle dimensioni. Le variazioni sono in ogni caso migliorative e tali da non alterare la natura e la funzionalità del prodotto stesso.



The THARA series presents tableware inspired by oriental cuisine, Chinese, Japanese and Thai. Not just a fashion but a lifestyle that conquers for its taste and style. The appearance is that of stoneware. Withstands temperatures from -20°C to +70°C.

La serie THARA presenta articoli da tavola ispirati alla cucina orientale, cinese, giapponese e thailandese. Non solo una moda ma uno stile di vita che conquista per il suo gusto e per il suo stile. L'aspetto è quello del gres. Termoresistente da -20°C a +70°C.

**Rice bowl**

Coppa riso
Reistasse
Bol à riz
Cuenco arroz

| art. | Ø cm. | h. | lt. | col. | € |
|----------|-------|----|-----|------|------|
| 44463-11 | 11 | 7 | 0,3 | ● | 4,72 |

**Tray**

Vassoio
Platte
Plateau
Bandeja

| art. | dim. cm. | col. | € |
|----------|------------|------|------|
| 44464-23 | 23,5x7,5x2 | ● | 5,23 |

**Tray**

Vassoio
Platte
Plateau
Bandeja

| art. | dim. cm. | col. | € |
|----------|--------------|------|------|
| 44465-24 | 24,5x6,5x1,5 | ● | 2,61 |



Bowl
Ciotola
Schüssel
Bol
Cuenco Ensalada

| art. | Ø cm. | h. | col. | € |
|----------|-------|-----|------|-------|
| 44452-31 | 31 | 8,5 | ○ | 22,71 |
| 44452B31 | 31 | 8,5 | ● | 22,71 |



Bowl
Ciotola
Schüssel
Bol
Cuenco Ensalada

| art. | dim. cm. | col. | € |
|----------|-------------|------|------|
| 44453-14 | 14,5x12x5,5 | ○ | 3,82 |
| 44453B14 | 14,5x12x5,5 | ● | 3,82 |



Bowl
Ciotola
Schüssel
Bol
Cuenco Ensalada

| art. | Ø cm. | h. | col. | € |
|----------|-------|----|------|------|
| 44454-11 | 11,5 | 4 | ○ | 3,62 |
| 44454B11 | 11,5 | 4 | ● | 3,62 |



Bowl
Ciotola
Schüssel
Bol
Cuenco Ensalada

| art. | dim. cm. | col. | € |
|----------|----------|------|------|
| 44455-09 | 9x7x2,5 | ○ | 2,21 |
| 44455B09 | 9x7x2,5 | ● | 2,21 |



Bowl
Ciotola
Schüssel
Bol
Cuenco Ensalada

| art. | dim. cm. | col. | € |
|----------|----------|------|------|
| 44456-14 | 14x9x2,5 | ○ | 3,42 |
| 44456B14 | 14x9x2,5 | ● | 3,42 |



Bowl
Ciotola
Schüssel
Bol
Cuenco Ensalada

| art. | dim. cm. | col. | € |
|----------|-----------|------|-------|
| 44457-32 | 32,5x14x4 | ○ | 10,85 |
| 44457B32 | 32,5x14x4 | ● | 10,85 |



Tray
Vassoio
Platte
Plateau
Bandeja

| art. | dim. cm. | col. | € |
|----------|---------------|------|------|
| 44461-20 | 18,5x18,5x4,5 | ○ | 6,33 |
| 44461B20 | 18,5x18,5x4,5 | ● | 6,33 |



Bowl
Ciotola
Schüssel
Bol
Cuenco Ensalada

| art. | dim. cm. | col. | € |
|----------|----------|------|-------|
| 44450-21 | 21x21x11 | ○ | 11,06 |
| 44450B21 | 21x21x11 | ● | 11,06 |



Bowl
Ciotola
Schüssel
Bol
Cuenco Ensalada

| art. | dim. cm. | col. | € |
|----------|----------|------|------|
| 44450-12 | 12x12x4 | ○ | 3,82 |
| 44450B12 | 12x12x4 | ● | 3,82 |



Bowl
Ciotola
Schüssel
Bol
Cuenco Ensalada

| art. | dim. cm. | col. | € |
|----------|-------------|------|------|
| 44450-17 | 17,5x17,5x7 | ○ | 7,74 |
| 44450B17 | 17,5x17,5x7 | ● | 7,74 |



Tray
Vassoio
Platte
Plateau
Bandeja

| art. | dim. cm. | col. | € |
|----------|----------|------|------|
| 44451-22 | 22x12x3 | ○ | 5,83 |
| 44451B22 | 22x12x3 | ● | 5,83 |



Tray
Vassoio
Platte
Plateau
Bandeja

| art. | dim. cm. | col. | € |
|----------|-----------|------|-------|
| 44462-25 | 25x25x5,5 | ○ | 12,86 |
| 44462B25 | 25x25x5,5 | ● | 12,86 |



Dish
Piatto
Teller
Assiette
Plato

| art. | Ø cm. | h. | col. | € |
|----------|-------|----|------|------|
| 44459-28 | 28 | 3 | ○ | 8,64 |
| 44459B28 | 28 | 3 | ● | 8,64 |



Bowl
Ciotola
Schüssel
Bol
Cuenco Ensalada

| art. | dim. cm. | h. | col. | € |
|----------|----------|----|------|------|
| 44450-11 | 11x10 | 3 | ○ | 2,01 |
| 44450B11 | 11x10 | 3 | ● | 2,01 |



Bowl
Ciotola
Schüssel
Bol
Cuenco Ensalada

| art. | dim. cm. | h. | col. | € |
|----------|----------|-----|------|------|
| 44450-13 | 13x11 | 3,5 | ○ | 3,22 |
| 44450B13 | 13x11 | 3,5 | ● | 3,22 |



Bowl
Ciotola
Schüssel
Bol
Cuenco Ensalada

| art. | dim. cm. | col. | € |
|----------|---------------|------|------|
| 44450-15 | 17,5x15,5x5,5 | ○ | 4,72 |
| 44450B15 | 17,5x15,5x5,5 | ● | 4,72 |



Tray
Vassoio
Platte
Plateau
Bandeja

| art. | dim. cm. | col. | € |
|----------|-------------|------|------|
| 44450-23 | 22x23,5x5,5 | ○ | 9,45 |
| 44450B23 | 22x23,5x5,5 | ● | 9,45 |



Soup/risotto bowl with lid
Ciotola riso con coperchio
Reisschüssel mit Deckel
Bol à riz avec couvercle
Cuenco arroz con tapa

| art. | Ø cm. | h. | € |
|----------|-------|-----|-------|
| 49655-34 | 10 | 6,5 | 11,46 |





Levantine cuisine served appropriately. Lots of vegetables, little meat and a variety of spices characterize the cuisine of the Middle East. The eastern Mediterranean region, i. e. Syria, Lebanon, Jordan, Israel and Palestine are referred to as the Levant. The food tradition of these countries are celebrated as a food trend.

Cucina levantina servita in modo appropriato. Tanta verdura, poca carne e una varietà di spezie caratterizzano la cucina del Medio Oriente. Le regioni del Mediterraneo orientale, come Siria, Libano, Giordania, Israele e Palestina sono indicati come Levante. Le tradizioni alimentari di questi paesi vengono celebrate come tendenza.



Bowl

Ciotola
Schale
Bol
Cuenco

| art. | Ø cm. | h. | € |
|----------|-------|-----|-------|
| 49656C10 | 9,5 | 4,2 | 12,96 |
| 49656C12 | 12,0 | 6,2 | 20,00 |
| 49656C17 | 17,0 | 9,0 | 30,65 |

Double wall. – Doppia parete.



Bowl

Ciotola
Schale
Bol
Cuenco

| art. | Ø cm. | h. | € |
|----------|-------|-----|-------|
| 49656B10 | 9,5 | 4,2 | 12,96 |
| 49656B12 | 12,0 | 6,2 | 20,00 |
| 49656B17 | 17,0 | 9,0 | 30,65 |

Double wall. – Doppia parete.



Bowl

Ciotola
Schale
Bol
Cuenco

| art. | Ø cm. | h. | € |
|----------|-------|-----|------|
| 49656C07 | 7,5 | 2,5 | 7,94 |



Bowl

Ciotola
Schale
Bol
Cuenco

| art. | Ø cm. | h. | € |
|----------|-------|-----|------|
| 49656B07 | 7,5 | 2,5 | 7,94 |



Bowl

Ciotola
Schale
Bol
Cuenco

| art. | Ø cm. | h. | € |
|----------|-------|-----|-------|
| 49656C08 | 8,5 | 5,5 | 11,96 |
| 49656C09 | 8,5 | 8,5 | 12,96 |



Bowl

Ciotola
Schale
Bol
Cuenco

| art. | Ø cm. | h. | € |
|----------|-------|-----|-------|
| 49656B08 | 8,5 | 5,5 | 11,96 |
| 49656B09 | 8,5 | 8,5 | 12,96 |



NEW

Set 6 dip bowls

Set 6 ciotoline
Satz 6 Dipschälchen
Set 6 bols
Juego 6 cuencos

| art. | Ø cm. | h. | ml. | € |
|----------|-------|-----|-----|-------|
| 49656C04 | 6 | 2,5 | 40 | 23,52 |
| 49656C06 | 6 | 4,5 | 60 | 25,02 |



NEW

Set 6 dip bowls

Set 6 ciotoline
Satz 6 Dipschälchen
Set 6 bols
Juego 6 cuencos

| art. | Ø cm. | h. | ml. | € |
|----------|-------|-----|-----|-------|
| 49656B04 | 6 | 2,5 | 40 | 23,52 |
| 49656B06 | 6 | 4,5 | 60 | 25,02 |



Tray

Vassoio
Tablett
Plateau
Bandeja

| art. | dim. cm. | € |
|----------|-----------|-------|
| 49656C26 | 25,5x16x3 | 25,83 |



Tray

Vassoio
Tablett
Plateau
Bandeja

| art. | dim. cm. | € |
|----------|-----------|-------|
| 49656B26 | 25,5x16x3 | 25,83 |



W

Tortillas cup

Contenitore per tortillas
Tortilla-Behälter
Conteneur à tortillas
Recipiente para tortillas

| art. | Ø cm. | € |
|----------|-------|-------|
| 44241-19 | 19 | 84,22 |



ABS

MF



Bento box with lid 7 pcs

Scatola bento con coperchio 7 pz
Bento-Box mit Deckel 7-tlg
Boîte à bento avec couvercle 7 pcs
Caja bento con tapa 7 pz

| art. | dim. cm. | € |
|----------|----------|---|
| 44357B07 | 30x25x8 | - |



SS

Taco holder, 2 pcs

Supporto per tacos, 2 pz
Taco-Ständer, 2 Stk
Support à tacos, 2 pcs
Soporte para tacos, 2 pz

| art. | dim. cm. | € |
|----------|----------|------|
| 49657-03 | 23x10x5 | 8,84 |



MF

Chinese spoon

Cucchiaio cinese
Chinesischer Löffel
Cuillère chinoise
Cuchara china

| art. | dim. cm. | col. | € |
|----------|----------|------|------|
| 44850-13 | 13,5x4,5 | ○ | 1,01 |
| 44850B13 | 13,5x4,5 | ● | 1,00 |



W

Sushi bridge

Ponte per sushi
Sushi-Brücke
Pont à sushi
Puente para sushi

| art. | dim. cm. | € |
|----------|------------|-------|
| 49655-41 | 38X18X12,5 | 75,98 |
| 49655-39 | 52x26x15 | 86,63 |





W

Sushi dragon boat

Barca per sushi dragone
Sushi-Drachenboot
Bateau à sushi dragon
Barco do dragão para sushi

| art. | dim. cm. | € |
|----------|----------|-------|
| 49657-09 | 40x10x16 | 74,17 |



W

Sushi boat

Barca per sushi
Sushi-Boot
Bateau à sushi
Barco para sushi

| art. | dim. cm. | € |
|----------|----------|-------|
| 49655-29 | 50x20x13 | 85,43 |



W



Hand roll stand

Supporto per temaki
Temaki-Ständer
Support pour temaki
Soporte para temaki

| art. | dim. cm. | € |
|----------|----------|-------|
| 49655-31 | 18x9x8,5 | 22,41 |



W

Sushi geta board

Tagliere sushi
Sushi-Servierbrett
Planche à sushi
Tabla para sushi

| art. | dim. cm. | € |
|----------|----------|-------|
| 49655-24 | 24x15x3 | 17,29 |
| 49655-67 | 27x18x3 | 19,30 |



W

Sushi ladder 5 steps

Espositore sushi 5 piani
Sushi-Display 5 Etagen
Présentoir à sushi 5 étages
Expositor de sushi 5 pisos

| art. | dim. cm. | € |
|----------|------------|-------|
| 49655-68 | 32,5x25x10 | 54,47 |



W

Sushi ladder 7 steps

Espositore sushi 7 piani
Sushi-Display 7 Etagen
Présentoir à sushi 7 étages
Expositor de sushi 7 pisos

| art. | dim. cm. | € |
|----------|----------|-------|
| 49655-69 | 38x26x15 | 58,89 |



W

Sushi ladder 6 steps

Espositore sushi 6 piani
Sushi-Display 6 Etagen
Présentoir à sushi 6 étages
Expositor de sushi 6 pisos

| art. | Ø cm. | h. | € |
|----------|-------|----|-------|
| 49655-73 | 28 | 12 | 55,58 |



W

Sushi box

Contentitore sushi
Sushi-Box
Boîte à sushi
Caja sushi

| art. | dim. cm. | € |
|----------|-------------|-------|
| 49657-12 | 32x21,5x4,5 | 36,18 |

With eutectic plate to be filled with water.
Con placca eutettica da riempire con acqua.



W

Sushi box

Contentitore sushi
Sushi-Box
Boîte à sushi
Caja sushi

| art. | dim. cm. | € |
|----------|-----------|-------|
| 49657-10 | 24x24x4,5 | 31,66 |



B

Sushi small boat

Barchetta sushi
Kleines Sushi-Boot
Petit bateau à sushi
Barco sushi pequeño

| art. | dim. cm. | € |
|----------|----------|------|
| 49657-30 | 29x10x5 | 8,34 |



W

Sushi box

Contentitore sushi
Sushi-Box
Boîte à sushi
Caja sushi

| art. | dim. cm. | € |
|----------|-----------|-------|
| 49657-11 | 20x30x4,5 | 35,28 |



B

Sushi container

Piatto presentazione sushi
Sushi-Behälter
Conteneur à sushi
Contenedor sushi

| art. | dim. cm. | € |
|----------|----------|-------|
| 49657-32 | 26x12x5 | 52,06 |



B

Sushi container

Piatto presentazione sushi
Sushi-Behälter
Conteneur à sushi
Contenedor sushi

| art. | dim. cm. | € |
|----------|----------|-------|
| 49657-33 | 32x12x10 | 58,69 |



B

Sushi container

Piatto presentazione sushi
Sushi-Behälter
Conteneur à sushi
Contenedor sushi

| art. | Ø cm. | h. | € |
|----------|-------|-------|--------|
| 49657-37 | 16 | 11+19 | 117,28 |





B

Sushi shell

Conchiglia sushi
Sushi-Schale
Coquille à sushi
Concha sushi

| art. | l. cm. | € |
|----------|--------|-------|
| 49657-31 | 20-24 | 36,88 |



B

Sushi container

Piatto presentazione sushi
Sushi-Behälter
Conteneur à sushi
Contenedor sushi

| art. | dim. cm. | € |
|----------|----------|-------|
| 49657-34 | 34x14x13 | 83,82 |



B

Sushi container

Piatto presentazione sushi
Sushi-Behälter
Conteneur à sushi
Contenedor sushi

| art. | dim. cm. | h. | € |
|----------|----------|------|-------|
| 49657-35 | 22x15 | 5+10 | 62,81 |



B

Sushi container

Piatto presentazione sushi
Sushi-Behälter
Conteneur à sushi
Contenedor sushi

| art. | Ø cm. | h. | € |
|----------|-------|-------|-------|
| 49657-36 | 16 | 10+17 | 69,55 |



Teapot

Teiera
Teekanne
Théière
Tetera

| art. | dim. cm. | h. | lt. | € |
|----------|----------|----|-----|-------|
| 49655R70 | 19,5x18 | 15 | 0,8 | 40,70 |

Cast iron with s/steel strainer. For 2-3 cups.
In ghisa con colino inox. Per 2-3 tazze.



Teapot

Teiera
Teekanne
Théière
Tetera

| art. | dim. cm. | h. | lt. | € |
|----------|----------|----|-----|-------|
| 49655-70 | 19,5x18 | 15 | 0,8 | 40,70 |

Cast iron with s/steel strainer. For 2-3 cups.
In ghisa con colino inox. Per 2-3 tazze.



Teapot warmer

Rechaud
Stövchen
Chauffe-théière
Calentador

| art. | Ø cm. | h. | € |
|----------|-------|-----|-------|
| 49655-72 | 13 | 7,5 | 27,64 |



Teapot

Teiera
Teekanne
Théière
Tetera

| art. | dim. cm. | h. | lt. | € |
|----------|----------|------|-----|-------|
| 49655-80 | 12,5x11 | 12,5 | 0,3 | 35,48 |

Cast iron, without tea strainer.
In ghisa, senza colino.



NEW



Teapot

Teiera
Teekanne
Théière
Tetera

| art. | dim. cm. | h. | lt. | € |
|----------|----------|----|-----|-------|
| 49655B91 | 17x14 | 17 | 0,8 | 40,70 |

Cast iron, inside enamelled. S/steel strainer.
In ghisa, interno smaltato. Colino inox.



NEW



Teapot

Teiera
Teekanne
Théière
Tetera

| art. | dim. cm. | h. | lt. | € |
|----------|----------|----|-----|-------|
| 49655G91 | 17x14 | 17 | 0,8 | 40,70 |

Cast iron, inside enamelled. S/steel strainer.
In ghisa, interno smaltato. Colino inox.



Coaster

Sottoteiera
Untersetzer
Repose théière
Reposa tetera

| art. | Ø cm. | h. | € |
|----------|-------|-----|------|
| 49655-81 | 13,5 | 1,5 | 9,25 |

Cast iron with non-slip feet.
In ghisa con piedini antiscivolo.



B



Tray

Vassoio
Tablett
Plateau
Bandeja

| art. | GN | dim. cm. | € |
|----------|-----|-------------|-------|
| 49655-86 | 1/2 | 32,5x26,5x3 | 21,91 |



MF

Chopsticks

Bacchette cinesi
Ess-Stäbchen
Baguettes
Palillos

| art. | l. cm. | pairs/paia | € |
|----------|--------|------------|-------|
| 49658-01 | 27 | 10 | 11,56 |



MF

Chopsticks

Bacchette cinesi
Ess-Stäbchen
Baguettes
Palillos

| art. | l. cm. | pairs/paia | € |
|----------|--------|------------|-------|
| 49658-02 | 27 | 10 | 11,56 |



B

Disposable chopsticks

Bacchette monouso
Einweg Ess-Stäbchen
Baguettes jetables
Palillos desechables

| art. | l. cm. | pairs/paia | € |
|----------|--------|------------|------|
| 48300-29 | 21 | 50 | 4,72 |



B

Disposable chopsticks

Bacchette monouso
Einweg Ess-Stäbchen
Baguettes jetables
Palillos desechables

| art. | l. cm. | pairs/paia | € |
|----------|--------|------------|-------|
| 49627-22 | 24 | 100 | 10,05 |



MF

Chopstick rest

Supporto bacchette cinesi
Ess-Stäbchen Ablage
Pose baguettes
Soporte para palillos

| art. | dim. cm. | col. | € |
|----------|-----------|------|------|
| 49655-27 | 5x3,5x1,8 | ● | 3,82 |



B

Noshikushi skewers

Spiedini noshikushi
Noshikushi Spieße
Brochettes noshikushi
Pinchos noshikushi

| art. | l. cm. | pcs/pz | € |
|----------|--------|--------|------|
| 48300-42 | 10,5 | 100 | 4,12 |



B

Tepokushi skewers

Spiedini tepokushi
Tepokushi Spieße
Brochettes tepokushi
Pinchos tepokushi

| art. | l. cm. | pcs/pz | € |
|----------|--------|--------|------|
| 48300-43 | 9 | 100 | 1,91 |
| 48300-33 | 15 | 100 | 2,41 |



B

Sushi mat

Stuoietta
Sushi-Matte
Natte à rouler les sushis
Mantelín para sushi

| art. | dim. cm. | € |
|----------|----------|------|
| 49626-00 | 24x24 | 2,91 |



B

Sushi mat

Stuoietta
Sushi-Matte
Natte à rouler les sushis
Mantelín para sushi

| art. | dim. cm. | € |
|----------|----------|------|
| 49626-02 | 27x27 | 2,61 |



W

Sushi mould

Stampo sushi
Sushi-Form
Moule à sushi
Molde para sushi

| art. | dim. cm. | € |
|----------|------------|-------|
| 49655-02 | 21x7,5x4,5 | 33,87 |



B

Rice paddle

Cucchiaio riso
Reislöffel
Cuillère à riz
Cuchara arroz

| art. | l. cm. | € |
|----------|--------|------|
| 49655-89 | 20 | 1,81 |



B

Rice knife

Coltello riso
Reismesser
Couteau à riz
Cuchillo arroz

| art. | l. cm. | € |
|----------|--------|------|
| 49655-90 | 17,5 | 2,21 |



W

Hangiri/sushi rice tub

Vasca riso hangiri
Hangiri/Sushi-Reis-Wanne
Bol à riz sushi/hangiri
Cuenco arroz sushi/hangiri

| art. | Ø cm. | € |
|----------|-------|--------|
| 49655-50 | 36 | 107,74 |
| 49655-49 | 45 | 205,42 |



B

Steamer

Cuocivapore
Dampfgarer
Panier vapeur
Vaporera

| art. | Ø cm. | € |
|----------|-------|--------|
| 49603-15 | 16 | 15,38 |
| 49603-20 | 20 | 19,30 |
| 49603-25 | 25 | 28,54 |
| 49603-30 | 30 | 35,48 |
| 49603-40 | 40 | 69,24 |
| 49603-50 | 50 | 103,82 |

2 bodies + 1 cover. – 2 ceste + 1 coperchio.



Steamer net liner, 6 pcs

Stuoietta cuocivapore, 6 pz
Matte zum Dämpfen, 6 Stk
Natte pour cuisson à la vapeur, 6 pcs
Mantelín para cocinar al vapor, 6 pz

| art. | Ø cm. | € |
|----------|-------|-------|
| 49614-15 | 15 | 4,32 |
| 49614-20 | 19 | 6,73 |
| 49614-25 | 24 | 11,26 |
| 49614-30 | 29 | 16,28 |
| 49614-40 | 39 | 43,52 |
| 49614-50 | 49 | 45,83 |



Wok with grid and cover, 3-ply

Wok c/griglia e coperchio, 3-ply
Wok mit Rost und Deckel, 3-ply
Wok avec grille et couvercle, 3-ply
Wok con rejilla y tapa, 3-ply

| art. | Ø cm. | h. | € |
|----------|-------|----|--------|
| 12529-32 | 32 | 8 | 118,39 |



Steel wok pan

Wok, ferro
Wok-Eisenpfanne
Poêle chinoise, acier
Wok, hierro

| art. | Ø cm. | h. | € |
|----------|-------|----|-------|
| 11713-32 | 32 | 10 | 41,10 |
| 11713-40 | 40 | 11 | 56,28 |



Steel wok pan

Wok, ferro
Wok-Eisenpfanne
Poêle chinoise, acier
Wok, hierro

| art. | Ø cm. | h. | € |
|----------|-------|----|-------|
| 49604-31 | 30,5 | 9 | 22,71 |
| 49604-36 | 35,5 | 11 | 23,92 |
| 49604-41 | 40,5 | 12 | 30,05 |

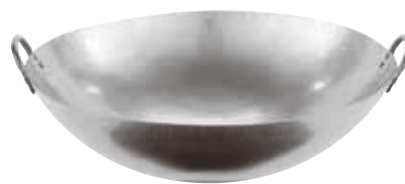

Steel wok pan

Wok, ferro
Wok-Eisenpfanne
Poêle chinoise, acier
Wok, hierro

| art. | Ø cm. | h. | € |
|----------|-------|------|--------|
| 49605-46 | 45,5 | 14,0 | 35,88 |
| 49605-61 | 61,0 | 18,5 | 68,64 |
| 49605-71 | 71,0 | 22,0 | 113,77 |



SS

Wok stand

Base per wok
Fuss für Wokpfanne
Base pour wok
Base para Wok

| art. | Ø cm. | € |
|----------|-------|-------|
| 11953-22 | 22 | 31,76 |



Steel fry pan

Padella per friggere, ferro
Frittier-Eisenpfanne
Tuile à frire, acier
Sartén freidora, hierro

| art. | Ø cm. | h. | lt. | € |
|----------|-------|------|------|--------|
| 41707-32 | 32 | 9,8 | 6,0 | 54,67 |
| 41707-36 | 36 | 11,0 | 8,8 | 69,45 |
| 41707-40 | 40 | 13,4 | 12,2 | 83,82 |
| 41707-45 | 45 | 15,0 | 17,3 | 111,76 |
| 41707-50 | 50 | 17,6 | 23,5 | 146,83 |



Wire basket, tinned

Cestello per friggere, stagnato
Frittier-Rost, verzinkt
Grille à frire, étamée
Cesta escurrefrito, estañada

| art. | Ø cm. | h. | € |
|----------|-------|------|--------|
| 41708-32 | 29,5 | 8,7 | 56,58 |
| 41708-36 | 32,6 | 9,3 | 73,26 |
| 41708-40 | 39,0 | 12,4 | 96,38 |
| 41708-45 | 43,0 | 15,0 | 136,88 |
| 41708-50 | 46,5 | 17,0 | - |



SS

Steamer

Cuocivapore
Dampf-Kocher
Cuiseur à vapeur
Cuscusera

| art. | Ø cm. | h. | € |
|----------|-------|----|-------|
| 49606-51 | 51 | 14 | 59,80 |
| 49606-00 | 51 | 14 | 42,31 |
| 49606-01 | 51 | 20 | 43,62 |



Mortar and pestle

Mortaio e pestello
Mörser und Stößel
Mortier et pilon
Mortero y pistilo

| art. | Ø cm. | h. | Kg. | € |
|----------|-------|------|-----|-------|
| 49618-12 | 12,5 | 9,0 | 1,9 | 35,58 |
| 49618-15 | 15,0 | 10,0 | 3,2 | 44,92 |
| 49618-18 | 17,0 | 11,5 | 3,9 | 56,58 |



SS

Wasabi grater

Grattugia per wasabi
Wasabi-Raffel
Rape à wasabi
Rallador para wasabi

| art. | dim. cm. | € |
|----------|----------|-------|
| 42555-11 | 11x7,5 | 13,97 |

Dishwasher safe. To mash garlic, wasabi, ginger, horseradish. To grind almonds, nutmeg.

Lavabile in lavastoviglie. Per grattugiare aglio, wasabi, zenzero, rafano, mandorle, noce moscata.



SS

Oil pourer

Oliera
Ölkanne
Huilière
Alcuza

| art. | ml. | € |
|----------|------|-------|
| 41780-05 | 500 | 25,93 |
| 41780-07 | 750 | 27,94 |
| 41780-09 | 1000 | 31,16 |



Chinese kitchen scissors

Forbici cucina cinesi
Chinesische Küchenschere
Ciseaux de cuisine chinois
Tijeras de cocina china

| art. | dim. cm. | € |
|----------|----------|-------|
| 49636-00 | 17x8,5 | 10,25 |

Stainless steel and brass. – Inox e ottone.



Fry basket, coarse mesh

Schiumarola fritto, rete grossa
Frittierkorb
Panier de friture
Cesta para freír

| art. | Ø cm. | € |
|----------|-------|-------|
| 49607-15 | 15,0 | 11,06 |
| 49607-20 | 20,0 | 17,99 |
| 49607-25 | 25,5 | 25,23 |
| 49607-30 | 30,5 | 36,88 |

Bamboo handle, stainless steel mesh.
Manico bamboo, rete inox.



Fry basket, fine mesh

Schiumarola fritto, rete fine
Frittierkorb
Panier de friture
Cesta para freír

| art. | Ø cm. | € |
|----------|-------|-------|
| 49608-15 | 15,0 | 16,58 |
| 49608-20 | 20,0 | 27,03 |
| 49608-25 | 25,5 | 39,70 |
| 49608-30 | 30,5 | 55,88 |
| 49608-35 | 35,5 | 71,25 |

Bamboo handle, stainless steel mesh.
Manico bamboo, rete inox.



Ladle

Mestolo
Schöpflöffel
Louche
Cacillo

| art. | Ø cm. | € |
|----------|-------|-------|
| 49609-12 | 11,8 | 16,88 |
| 49609-14 | 13,8 | 22,71 |

Stainless steel and natural wood.
Inox e legno naturale.



Spatula

Paletta
Teigschäber
Spatule
Espátula

| art. | dim. cm. | € |
|----------|----------|-------|
| 49610-11 | 11x10,2 | 14,07 |
| 49610-14 | 13,3x12 | 18,09 |

Stainless steel and natural wood.
Inox e legno naturale.



Wok brush

Pennello per wok
Wok-Pinsel
Pinceaux à wok
Pincel para wok

| art. | l. cm. | € |
|----------|--------|------|
| 49634-00 | 31 | 3,82 |

B



PIZZA

ETHNIC CUISINE
CUCINA ETNICA





SS

Oil pourer

Oliera
Ölkanne
Huilière
Alcuza

| art. | lt. | € |
|----------|------|-------|
| 41780-05 | 0,50 | 25,93 |
| 41780-07 | 0,75 | 27,94 |
| 41780-09 | 1,00 | 31,16 |



Pizza peel, aluminum

Pala pizza, alluminio
Pizzaschaufel, Aluminium
Pelle à pizza, aluminum
Pala pizza, aluminio

| art. | Ø cm. | l. cm. | gr. | € |
|----------|-------|--------|------|--------|
| 11701-02 | 32 | 150 | 736 | 112,86 |
| 11701-06 | 37 | 150 | 870 | 126,23 |
| 11701-10 | 41 | 150 | 1226 | 157,08 |
| 11701-13 | 45 | 150 | 1460 | 164,32 |
| 11701-16 | 50 | 150 | 1604 | 187,63 |



Pizza peel, aluminum

Pala pizza, alluminio
Pizzaschaufel, Aluminium
Pelle à pizza, aluminum
Pala pizza, aluminio

| art. | cm. | l. cm. | gr. | € |
|----------|-------|--------|------|--------|
| 11702-02 | 32x32 | 150 | 784 | 112,36 |
| 11702-06 | 37x37 | 150 | 894 | 127,64 |
| 11702-10 | 41x41 | 150 | 1246 | 151,05 |
| 11702-16 | 50x50 | 150 | 1694 | 181,60 |



Perforated pizza peel, aluminum

Pala pizza forata, alluminio
Pizzaschaufel, gelocht, Aluminium
Pelle à pizza perforée, aluminum
Pala pizza perforada, aluminio

| art. | cm. | l. cm. | gr. | € |
|----------|-------|--------|------|--------|
| 11704-02 | 32x32 | 150 | 700 | 143,41 |
| 11704-06 | 37x37 | 150 | 816 | 162,51 |
| 11704-13 | 45x45 | 150 | 1250 | 192,46 |
| 11704-16 | 50x50 | 150 | 1409 | 216,98 |



SS

Pizza peel, small

Palettino
Pizzaschaufel, klein
Petite pelle à pizza
Pala pizza, pequeña

| art. | Ø cm. | l. cm. | gr. | € |
|----------|-------|--------|-----|--------|
| 11705-02 | 17 | 150 | 780 | 93,87 |
| 11705-06 | 20 | 150 | 846 | 96,28 |
| 11705-10 | 23 | 150 | 938 | 102,91 |
| 11705-14 | 26 | 150 | 984 | 105,32 |



SS

Perforated pizza peel, small

Palettino forato
Pizzaschaufel, gelocht, klein
Petite pelle à pizza perforée
Pala pizza perforada, pequeña

| art. | Ø cm. | l. cm. | gr. | € |
|----------|-------|--------|-----|--------|
| 11706-02 | 17 | 150 | 770 | 111,15 |
| 11706-06 | 20 | 150 | 830 | 110,65 |
| 11706-10 | 23 | 150 | 912 | 115,68 |
| 11706-14 | 26 | 150 | 954 | 121,50 |



Oven pizza peel, aluminum

Pala per infornare, alluminio
Back-Pizzaschaufel, Aluminium
Pelle à enfourner, aluminum
Pala para hornear, aluminio

| art. | cm. | l. cm. | gr. | € |
|----------|-------|--------|------|--------|
| 41765-32 | 32x32 | 150 | 1200 | 101,91 |
| 41765-37 | 37x37 | 150 | 1400 | 109,04 |
| 41765-41 | 41x41 | 150 | 1500 | 137,38 |
| 41765-45 | 45x45 | 150 | 1600 | 154,37 |
| 41765-50 | 50x50 | 150 | 1700 | 182,01 |



SS

Oven pizza peel

Pala per infornare
Back-Pizzaschaufel
Pelle à enfourner
Pala para hornear

| art. | Ø cm. | l. cm. | gr. | € |
|----------|-------|--------|-----|---|
| 41735-29 | 29 | 150 | 870 | - |

Aluminum handle. – Manico alluminio.



Oven pizza peel, aluminum

Pala per infornare, alluminio
Back-Pizzaschaufel, Aluminium
Pelle à enfourner, aluminum
Pala para hornear, aluminio

| art. | cm. | l. cm. | gr. | € |
|----------|-------|--------|-----|-------|
| 41736-32 | 32x30 | 150 | 954 | 40,70 |



SS

Perforated pizza peel, small

Palettino forato
Pizzaschaufel, gelocht, klein
Petite pelle à pizza perforée
Pala pizza perforada, pequeña

| art. | Ø cm. | l. cm. | gr. | € |
|----------|-------|--------|-----|-------|
| 41737-17 | 17 | 150 | 890 | 83,62 |
| 41737-20 | 20 | 150 | 910 | 85,73 |
| 41737-23 | 23 | 150 | 960 | 90,75 |



SS

Pizza peel, small

Palettino
Pizzaschaufel, klein
Petite pelle à pizza
Pala pizza, pequeña

| art. | Ø cm. | l. cm. | gr. | € |
|----------|-------|--------|------|-------|
| 41738-17 | 17 | 150 | 905 | 72,56 |
| 41738-20 | 20 | 150 | 975 | 74,77 |
| 41738-23 | 23 | 150 | 1030 | 76,78 |



Pizza peel, small, aluminum

Palettino, alluminio
Pizzaschaufel, klein, Aluminium
Petite pelle à pizza, aluminium
Pala pizza, pequeña, aluminio

| art. | Ø cm. | l. cm. | gr. | € |
|----------|-------|--------|-----|-------|
| 41735-20 | 20 | 150 | 800 | 37,19 |



W

Pizza peel

Pala pizza
Pizzaschaufel
Pelle à enfourner
Pala pizza

| art. | Ø cm. | l. cm. | € |
|----------|-------|--------|--------|
| 41764-33 | 33 | 200 | 148,44 |



SS

Ash shovel

Paletta cenere
Asche-Schaufel
Pelle à cendres
Paleta recogedar cenizas

| art. | cm. | l. cm. | € |
|----------|-------|--------|-------|
| 41768-21 | 21x31 | 173 | 72,36 |



SS

Rake

Rastrello
Harke
Râteau
Rastrillo

| art. | cm. | l. cm. | € |
|----------|-------|--------|-------|
| 41768-22 | 24x10 | 150 | 55,88 |



Adjustable brush

Spazzola orientabile
Drehbare Bürste
Brosse orientable
Cepillo orientable

| art. | cm. | l. cm. | € |
|----------|--------|--------|-------|
| 41767-20 | 20x6,5 | 155 | 92,16 |

Brass bristles. – Setole ottone.



Adjustable brush

Spazzola orientabile
Drehbare Bürste
Brosse orientable
Cepillo orientable

| art. | cm. | l. cm. | € |
|----------|------|--------|--------|
| 41766-27 | 27x7 | 150 | 110,45 |

Brass bristles. – Setole ottone.



Adjustable brush

Spazzola orientabile
Drehbare Bürste
Brosse orientable
Cepillo orientable

| art. | cm. | l. cm. | € |
|----------|------|--------|-------|
| 41766-16 | 16x5 | 150 | 60,50 |

Brass bristles. – Setole ottone.



Adjustable brush

Spazzola orientabile
Drehbare Bürste
Brosse orientable
Cepillo orientable

| art. | cm. | l. cm. | € |
|----------|------|--------|--------|
| 41766-14 | 14x7 | 150 | 105,63 |



Adjustable brush

Spazzola orientabile
Drehbare Bürste
Brosse orientable
Cepillo orientable

| art. | cm. | l. cm. | € |
|----------|--------|--------|-------|
| 41739-20 | 20x6,6 | 150 | 85,12 |



SS

Support for peels

Poggia pala pizza
Schaufelträger
Support pour pelles à pizza
Soporte palas

| art. | cm. | fits/per | € |
|----------|----------|----------|--------|
| 41769-36 | 40x16x39 | max Ø 36 | 173,06 |
| 41769-50 | 52x16x34 | max Ø 50 | 186,83 |



Small pizza peel wall rack, aluminum

Portapaletto da muro, alluminio
Pizzaschaufel-Wandgestell, Aluminum
Support mural petite pelle, aluminium
Soporte pala mural, aluminio

| art. | cm. | € |
|----------|---------|-------|
| 41769-02 | 32x10x5 | 35,28 |



Pizza peel wall rack, aluminum

Appendi pala da muro, alluminio
Pizzaschaufel-Wandgestell, Aluminum
Support mural pour pelle, aluminium
Soporte pala mural, aluminio

| art. | cm. | € |
|----------|----------|-------|
| 41769-01 | 17,5x9x9 | 40,40 |



Double-sided brush

Spazzola bi-facciale
Doppelseitige Bürste
Brosse double face
Cepillo doble

| art. | l. cm. | € |
|----------|--------|-------|
| 41761-02 | 100 | 76,48 |



SS

Pizza peel rack, marble base

Porta pale, base marmo
Schaufeln-Ständer, Marmorsockel
Support pour pelles, socle marbre
Soporte palas, pie marmol

| art. | cm. | € |
|----------|-----------|--------|
| 41769-00 | 25x35x175 | 247,53 |

Double front. For peels H 150 cm.
Doppio fronte/retro. Per pale da 150 cm.



SS

Pizza peel rack, marble base

Porta pale, base marmo
Schaufeln-Ständer, Marmorsockel
Support pour pelles, socle marbre
Soporte palas, pie marmol

| art. | cm. | € |
|----------|-----------|--------|
| 41769G00 | 25x35x233 | 240,30 |

Supplied WITHOUT peels. With Gluten Free sign.
Fornito SENZA pale. Con logo Gluten Free,



Adjustable brush

Spazzola orientabile
Drehbare Bürste
Brosse orientable
Cepillo orientable

| art. | cm. | l. cm. | € |
|----------|------|--------|--------|
| 41767G20 | 20x6 | 160 | 112,26 |

Brass bristles. – Setole ottone.



Pizza peel, aluminum

Pala pizza, alluminio
Pizzaschaufel, Aluminum
Pelle à pizza, aluminium
Pala pizza, aluminio

| art. | cm. | l. cm. | € |
|----------|-------|--------|--------|
| 41704G33 | 33x33 | 150 | 172,86 |
| 41704G36 | 36x36 | 150 | 196,78 |



SS

Perforated pizza peel, small

Palettino forato
Pizzaschaufel, gelocht, klein
Petite pelle à pizza perforée
Pala pizza perforada, pequeña

| art. | Ø cm. | l. cm. | € |
|----------|-------|--------|--------|
| 41737G20 | 20 | 150 | 133,36 |
| 41737G23 | 23 | 150 | 138,09 |



SS

Pan gripper

Pinza per teglie
Pizzablech-Zange
Pince à plaques
Pinza fuente horns

| art. | l. cm. | € |
|----------|--------|-------|
| 42822-00 | 23 | 17,79 |



SS

Pan gripper

Pinza per teglie
Pizzablech-Zange
Pince à plaques
Pinza fuente horns

| art. | l. cm. | € |
|----------|--------|-------|
| 18323-00 | 23 | 12,56 |



SS

Pizza cutter

Tronchetto tagliapizza
Pizzaschneider
Coupe-pizza
Cortador de pizza

| art. | Ø cm. | l. cm. | € |
|----------|-------|--------|------|
| 18324-00 | 13,5 | 19 | 8,34 |



SS

Pizza wheel

Rotella taglia pizza
Pizzaschneider
Roulette à pizza
Ruleta cortapizzas

| art. | Ø cm. | € |
|----------|-------|-------|
| 18324-10 | 10 | 10,85 |



SS

Divisible pizza scissors

Forbice pizza smontabile
Pizzaschere, teilbar
Ciseaux à pizza, divisible
Tijeras para pizza desmontables

| art. | l. cm. | € |
|----------|--------|------|
| 18276-00 | 25 | 7,54 |



SS

Pizza knife

Coltello per pizzaiolo
Pizzamesser
Couteau à pizza
Cuchillo para pizza

| art. | l. cm. | € |
|----------|--------|------|
| 48280-45 | 23 | 7,44 |



SS

Perforated spatula

Paletta triangolare, forata
Palette, gelocht
Palette perforée
Pala triangular perforada

| art. | cm. | € |
|----------|-------|-------|
| 18301-01 | 12x15 | 14,57 |



SS

Spatula

Paletta triangolare
Palette
Palette
Pala triangular

| art. | cm. | € |
|----------|-------|-------|
| 18301-02 | 12x15 | 12,96 |



Peel with handle, aluminum

Pala manicata, alluminio
Schaufel mit Griff, Aluminum
Pelle avec manche, alu
Pala con mango, aluminio

| art. | Ø cm. | € |
|----------|-------|-------|
| 42826-32 | 32 | 48,84 |
| 42826-37 | 37 | 54,07 |



SS

Perforated peel with handle

Pala manicata, forata
Schaufel mit Griff, gelocht
Pelle perforée avec manche
Pala con mango, perforada

| art. | cm. | € |
|----------|-------|-------|
| 18302-01 | 22x18 | 25,53 |



SS

Peel with handle

Pala manicata
Schaufel mit Griff
Pelle avec manche
Pala con mango

| art. | cm. | € |
|----------|-------|-------|
| 18302-02 | 22x18 | 25,63 |



W

Round platter

Vassoio rotondo
Buchenholzbrett, rund
Plateau rond
Bandeja redonda

| art. | Ø cm. | h. cm. | € |
|----------|-------|--------|-------|
| 41774-33 | 33 | 1,2 | 49,75 |

Beech wood. – Faggio.



W

Cutting board 1 portion

Tagliere monoporzione
Einzelportion Tablett
Planche mono-portion
Tabla monoporción

| art. | cm. | € |
|----------|-----------|-------|
| 41775-34 | 34x20x1,2 | 40,10 |

Beech wood. – Faggio.



MF

Round platter

Vassoio rotondo
Tablett, rund
Plateau rond

Bandeja redonda

| art. | Ø cm. | h. mm. | € |
|----------|-------|--------|-------|
| 44473-02 | 33 | 0,8 | 21,91 |
| 44473-03 | 43 | 0,8 | 38,79 |



Pizza plate with wooden platter

Piatto pizza con tagliere legno
Pizzaplatte mit Holzbrett
Plat pizza avec planche bois

Fuente pizza con tabla madera

| art. | Ø cm. | € |
|----------|-------|-------|
| 44232S16 | 16 | 70,25 |
| 44232S20 | 20 | 98,09 |

Enamelled cast iron plate.
Piatto in ghisa smaltata.



Pizza plate with wooden platter

Piatto pizza con tagliere legno
Pizzaplatte mit Holzbrett
Plat pizza avec planche bois

Fuente pizza con tabla madera

| art. | Ø cm. | € |
|----------|-------|--------|
| 44233-20 | 20 | 100,60 |

Enamelled cast iron plate. Cups not included.
Piatto in ghisa smaltata. Ciotoline non incluse.

MODULAR SYSTEM BASE=LID EXTENSIBLE HEIGHT
SISTEMA MODULARE BASE=COPERCHIO ALTEZZA
ESTENSIBILE



The modular system where the base and lid are the same element. Rotation system allows the steam of hot pizzas to escape.

Sistema modulare, la base e coperchio sono lo stesso elemento. Dotato di sistema rotabile, per la fuoriuscita del vapore delle pizze calde.



PPE

Base and lid
Base e coperchio
Basis und Abdeckung
Base et couvercle
Base y tapa

| art. | cm. ext. | int. | € |
|----------|-----------|-----------|-------|
| 44975-50 | 57x57x9,5 | 51x51x6,3 | 49,75 |



PPE

Extender
Estensore
Aufsatz
Réhausse
Extensión

| art. | cm. ext. | int. | € |
|----------|-----------|---------------|-------|
| 44975H50 | 57x57x9,5 | 51x51x7,5x9,5 | 48,04 |



PPE

Insulated container
Contenitore isoteramico
Thermobehälter
Conteneur isotherme
Contenedor isotérmico

| art. | cm. | lt. | € |
|----------|------------|-----|-------|
| 44961-03 | 42x42x34,5 | 36 | 95,98 |

With steam release system. For pizza boxes max 36x36 cm. – Con sistema di rilascio del vapore. Per cartoni pizza max 36x36 cm.



PPE

Insulated container with handle
Contenitore isoteramico con maniglia
Thermobehälter mit Grill
Conteneur isotherme avec manche
Contenedor isotérmico con asa

| art. | cm. | lt. | € |
|----------|------------|-----|--------|
| 44961M03 | 42x42x34,5 | 36 | 122,71 |



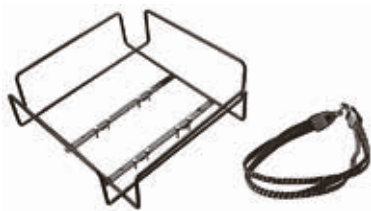

Bike basket rack + elastic hook

Cestello portapacco bike + gancio elastico
Fahrradträgerkorb + elastischer Haken
Porte-panier pour vélos + crochet élastique
Canasta para bicicletas + gancho elástico

| art. | cm. | € |
|----------|----------|-------|
| 44962-01 | 46x46x16 | 88,34 |

With 8 self-locking screws. Max platform capacity 25 kg. – Completo di 8 viti autobloccanti. Portata massima pianale 25 kg.



Pizza delivery bag

Borsa isotermitica
Thermo-Tasche
Sac thermique
Bolsa térmica

| art. | cm. | cap. | € |
|----------|----------|-------|---|
| 44960-01 | 55x50x20 | 3xø45 | - |



Pizza delivery bag

Borsa isotermitica
Thermo-Tasche
Sac thermique
Bolsa térmica

| art. | cm. | cap. | € |
|----------|----------|-------|-------|
| 44960-04 | 46x44x20 | 4xø30 | 67,54 |



Pizza delivery bag

Borsa isotermitica
Thermo-Tasche
Sac thermique
Bolsa térmica

| art. | cm. | cap. | € |
|----------|----------|-------|--------|
| 44960-06 | 34x34x19 | 5xø33 | 70,65 |
| 44960-07 | 42x42x19 | 4xø40 | 114,17 |



Pizza delivery bag

Borsa isotermitica
Thermo-Tasche
Sac thermique
Bolsa térmica

| art. | cm. | cap. | € |
|----------|----------|-------|-------|
| 44960-02 | 46x46x12 | 2xø40 | 39,70 |
| 44960-03 | 50x51x11 | 2xø45 | 42,21 |



Sandwich delivery bag

Borsa isotermitica
Thermo-Tasche
Sac thermique
Bolsa térmica

| art. | cm. | € |
|----------|----------|-------|
| 44960-13 | 39x27x30 | 34,57 |

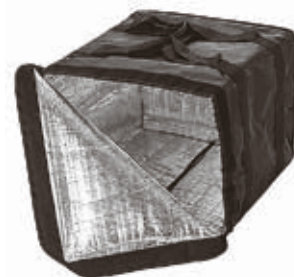

Pizza delivery bag

Borsa isotermitica
Thermo-Tasche
Sac thermique
Bolsa térmica

| art. | cm. | € |
|----------|----------|-------|
| 44960-10 | 51x46x41 | 65,02 |



Pizza delivery bag

Borsa isotermitica
Thermo-Tasche
Sac thermique
Bolsa térmica

| art. | cm. | € |
|----------|----------|-------|
| 44960-11 | 48x48x70 | 81,81 |



Pizza delivery bag with rack
Borsa isotermitica con rastrelliera
Thermo-Tasche mit Gestell
Sac thermique avec étagère
Bolsa térmica con rack

| art. | cm. | cap. | € |
|----------|----------|-------|-------|
| 44960K10 | 51x46x41 | 6xø45 | 87,94 |

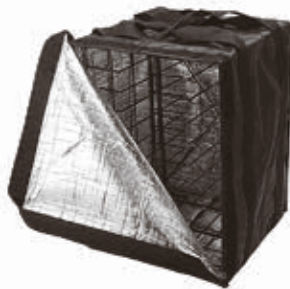

Pizza delivery bag with rack
Borsa isotermitica con rastrelliera
Thermo-Tasche mit Gestell
Sac thermique avec étagère
Bolsa térmica con rack

| art. | cm. | cap. | € |
|----------|----------|--------|--------|
| 44960K11 | 48x48x70 | 10xø45 | 102,41 |



Pizza delivery backbag
Zaino isotermitico
Thermo-Rucksack
Sac à dos thermique
Mochila térmica

| art. | cm. | € |
|----------|----------|--------|
| 44962-05 | 45x45x38 | 188,14 |

Polyester and nylon. With inner PP insulataed container. For pizza boxes up to 35x35 cm. – Poliestere e nylon. Interno con contenitore isotermitico in PP. Per scatole pizza fino a 35x35 cm.



Pizza screen, aluminum
Retina pizza, alluminio
Pizzanetzscheibe, Aluminum
Toile à pizza, aluminium
Red para pizza, aluminio

| art. | cm. | € |
|----------|-------|-------|
| 41734-60 | 60x40 | 32,76 |



Pizza screen, aluminum
Retina pizza, alluminio
Pizzanetzscheibe, Aluminum
Toile à pizza, aluminium
Red para pizza, aluminio

| art. | Ø cm. | € |
|----------|-------|-------|
| 41727-28 | 28 | 8,14 |
| 41727-30 | 30 | 9,75 |
| 41727-33 | 33 | 10,45 |
| 41727-36 | 36 | 13,47 |
| 41727-40 | 40 | 15,28 |

Without seam. – Senza giunzione.



Pizza screen, aluminum
Retina pizza, alluminio
Pizzanetzscheibe, Aluminum
Toile à pizza, aluminium
Red para pizza, aluminio

| art. | Ø cm. | € |
|----------|-------|-------|
| 41727-45 | 45 | 19,20 |
| 41727-50 | 50 | 23,22 |
| 41727-55 | 55 | 26,03 |
| 41727-60 | 60 | 29,65 |

Without seam. – Senza giunzione.



SS

Pizza screen rack
Rastrelliera per retine
Pizzanetzscheiben-Träger
Etagère à toiles
Rack para red para pizza

| art. | cm. | € |
|----------|---------|-------|
| 41771-96 | 23x35,6 | 59,60 |

Suitable for 96 screens.
Può contenere 96 retine.



SS

Pizza pan rack
Rastrelliera per teglie pizza
Pizzableche-Träger
Etagère pour plaques à pizza
Rack para placas pizza

| art. | cm. | € |
|----------|--------------|-------|
| 41770-15 | 30,5x30,5x70 | 74,87 |

Rails h.3,5 cm. for sheets up to Ø 36 cm.
Distanza piani cm 3,5, per teglie max ø 36 cm.



Baking tray, alusteel
Teglia forno, acciaio alluminato
Backblech mit Aluminumüberzug
Plaque à pizza, tôle aluminée
Placa pizza, acero aluminizado

| art. | Ø cm. | h. cm. | U. Pack | € |
|----------|-------|--------|---------|------|
| 11739-20 | 20 | 2,5 | 10 | 4,52 |
| 11739-24 | 24 | 2,5 | 10 | 5,73 |
| 11739-28 | 28 | 2,5 | 10 | 7,64 |
| 11739-32 | 32 | 2,5 | 10 | 8,64 |



Pizza pan, heavy blue steel
Teglia pizza, ferro blu pesante
Pizzablech, Blaublech, Schwerausführung
Plaque à pizza, tôle forte bleuie
Placa pizza, hierro pesante

| art. | Ø cm. | h. cm. | U. Pack | € |
|----------|-------|--------|---------|------|
| 11744-20 | 20 | 2,5 | 10 | 4,32 |
| 11744-24 | 24 | 2,5 | 10 | 5,73 |
| 11744-28 | 28 | 2,5 | 10 | 7,34 |
| 11744-32 | 32 | 2,5 | 10 | 8,04 |



Pizza pan, perforated, non stick coated
Teglia pizza forata, antiaderente
Pizzablech, gelocht, beschichtet
Plaque à pizza perforée, anti-adhésive
Placa pizza perforada, antiaderente

| art. | Ø cm. | h. cm. | € |
|----------|-------|--------|-------|
| 41729-30 | 29/27 | 1,5 | 11,56 |
| 41729-34 | 33/30 | 1,5 | 16,08 |



Pizza pan double non stick-coating
Teglia pizza, antiaderente a 2 strati
Pizzablech mit Doppel-Beschichtung
Plaque à pizza, double revêtement
Placa pizza antiaderente, 2 capas

| art. | Ø cm. | h. cm. | U. Pack | € |
|----------|-------|--------|---------|-------|
| 11741-20 | 20 | 2,5 | 5 | 9,65 |
| 11741-24 | 24 | 2,5 | 5 | 11,86 |
| 11741-26 | 26 | 2,5 | 5 | 13,07 |
| 11741-28 | 28 | 2,5 | 5 | 14,97 |
| 11741-32 | 32 | 2,5 | 5 | 17,29 |

Heat resistant up to 280°C. – Resistente a 280 °C.



Pizza pan, blue steel
Teglia pizza, ferro blu
Pizza-Blaublech
Plaque à pizza, tôle bleuie
Placa pizza, hierro

| art. | Ø cm. | h. cm. | U. Pack | € |
|----------|-------|--------|---------|------|
| 11740-14 | 14 | 2,5 | 5 | 3,12 |
| 11740-16 | 16 | 2,5 | 5 | 3,22 |
| 11740-18 | 18 | 2,5 | 5 | 3,52 |
| 11740-20 | 20 | 2,5 | 5 | 3,62 |
| 11740-22 | 22 | 2,5 | 5 | 4,52 |
| 11740-24 | 24 | 2,5 | 5 | 5,13 |



Pizza pan, blue steel
Teglia pizza, ferro blu
Pizza-Blaublech
Plaque à pizza, tôle bleuie
Placa pizza, hierro

| art. | Ø cm. | h. cm. | U. Pack | € |
|----------|-------|--------|---------|-------|
| 11740-26 | 26 | 2,5 | 5 | 5,43 |
| 11740-28 | 28 | 2,5 | 5 | 6,03 |
| 11740-30 | 30 | 2,5 | 5 | 6,53 |
| 11740-32 | 32 | 2,5 | 5 | 7,14 |
| 11740-36 | 36 | 2,5 | 5 | 8,74 |
| 11740-40 | 40 | 2,5 | 5 | 10,35 |



Pizza pan, blue steel
Teglia pizza, ferro blu
Pizza-Blaublech
Plaque à pizza, tôle bleuie
Placa pizza, hierro

| art. | Ø cm. | h. cm. | U. Pack | € |
|----------|-------|--------|---------|------|
| 11742-16 | 16 | 3,5 | 10 | 3,72 |
| 11742-18 | 18 | 3,5 | 10 | 3,72 |
| 11742-20 | 20 | 3,5 | 10 | 4,72 |
| 11742-22 | 22 | 3,5 | 10 | 5,13 |
| 11742-24 | 24 | 3,5 | 10 | 5,53 |
| 11742-26 | 26 | 3,5 | 10 | 5,83 |
| 11742-28 | 28 | 3,5 | 10 | 6,93 |



Pizza pan, blue steel

Teglia pizza, ferro blu
Pizza-Blaublech
Plaque à pizza, tôle bleuie
Placa pizza, hierro

| art. | Ø cm. | h. cm. | U. Pack | € |
|----------|-------|--------|---------|-------|
| 11742-30 | 30 | 3,5 | 10 | 7,34 |
| 11742-32 | 32 | 3,5 | 5 | 8,74 |
| 11742-36 | 36 | 3,5 | 5 | 9,15 |
| 11742-40 | 40 | 3,5 | 5 | 11,16 |
| 11742-45 | 45 | 4,0 | 5 | 13,67 |
| 11742-50 | 50 | 4,0 | 5 | 15,78 |
| 11742-60 | 60 | 4,0 | 5 | 25,83 |



Baking tray, blue steel, rectangular

Teglia rettangolare, ferro blu
Blaublech, rechteckig
Plaque rectangulaire, tôle bleuie
Placa rectangular, hierro

| art. | cm. | h. cm. | € |
|----------|-------|--------|-------|
| 41745-30 | 30x23 | 3 | 12,76 |
| 41745-35 | 35x28 | 3 | 14,17 |
| 41745-40 | 40x30 | 3 | 15,58 |
| 41745-50 | 50x35 | 3 | 18,89 |
| 41745-60 | 60x40 | 3 | 22,81 |
| 41745-65 | 65x45 | 3 | 26,93 |



Baking tray, alusteel

Teglia, alluminata
Backblech, Aluminumüberzug
Plaque rectangulaire, tôle aluminisée
Placa rectangular, acero aluminizado

| art. | cm. | h. cm. | € |
|----------|-------|--------|-------|
| 41746-60 | 60x40 | 2 | 18,39 |



Baking tray, alusteel

Teglia, alluminata
Backblech, Aluminumüberzug
Plaque rectangulaire, tôle aluminisée
Placa rectangular, acero aluminizado

| art. | cm. | h. cm. | € |
|----------|-------|--------|-------|
| 41751-30 | 30x23 | 3 | 13,77 |
| 41751-35 | 35x28 | 3 | 13,77 |
| 41751-40 | 40x30 | 3 | 16,08 |
| 41751-50 | 50x35 | 3 | 18,39 |
| 41751-60 | 60x40 | 3 | 21,51 |
| 41751-65 | 65x45 | 3 | 25,73 |



Baking tray, aluminum

Teglia, alluminio
Backblech, Aluminium
Plaque à cuisson, aluminium
Placa pastelería, aluminio

| art. | cm. | GN | € |
|----------|---------|-----|-------|
| 41744-32 | 53x32,5 | 1/1 | 20,40 |
| 41744-53 | 53x65 | 2/1 | 55,48 |
| 41744-60 | 60x40 | - | 28,84 |

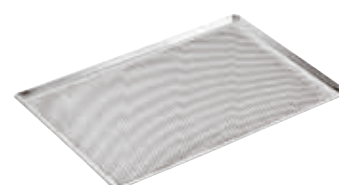

Baking tray perforated, aluminum

Teglia forata, alluminio
Backblech, gelocht, Aluminium
Plaque perforée, aluminium
Placa perforada, aluminio

| art. | cm. | € |
|----------|---------|-------|
| 41756-30 | 30x40 | 22,11 |
| 41756-32 | 53x32,5 | 26,93 |
| 41756-53 | 53x65 | 51,76 |
| 41756-60 | 60x40 | 44,72 |

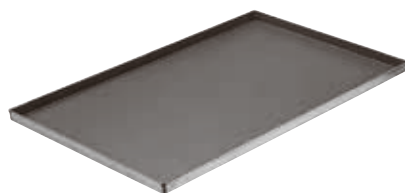

Baking tray, non stick coated

Teglia antiaderente
Blech mit Antihafbeschichtung
Plaque avec revêtement anti-adhésif
Placa antiaderente

| art. | cm. | h. cm. | € |
|----------|-------|--------|-------|
| 41747-60 | 60x40 | 2 | 57,79 |



Baking tray, non stick coated

Teglia antiaderente
Blech mit Antihafbeschichtung
Plaque avec revêtement anti-adhésif
Placa antiaderente

| art. | Ø cm. | GN | pcs/pz | € |
|----------|-------|-----|--------|-------|
| 41755-11 | 12,5 | 1/1 | 6 | 88,34 |



Baking tray, silicone coated

Teglia siliconata
Backblech Silikonbeschichtet
Plaque avec revêtement silicone
Placa siliconada

| art. | cm. | GN | € |
|----------|---------|-----|-------|
| 41743D32 | 53x32,5 | 1/1 | 32,16 |
| 41743D53 | 53x65 | 2/1 | 55,48 |
| 41743D60 | 60x40 | - | 45,43 |

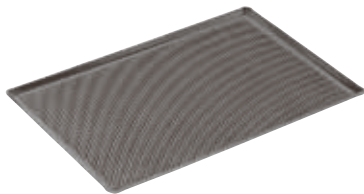

Baking tray perforated, silicone coated

Teglia forata, siliconata
Backblech, gelocht, Silikonbeschichtet
Plaque perforée, revêtement silicone
Placa perforada, siliconada

| art. | cm. | GN | € |
|----------|---------|-----|-------|
| 41753D30 | 30x40 | - | 25,93 |
| 41753D32 | 53x32,5 | 1/1 | 35,88 |
| 41753D53 | 53x65 | 2/1 | 56,58 |
| 41753D60 | 60x40 | - | 39,90 |

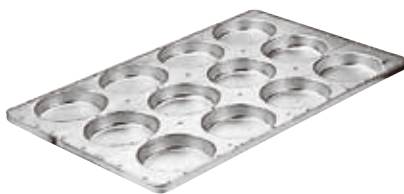

Baking tray, alusteel

Teglia, alluminata
Backblech, Aluminumüberzug
Plaque, tôle aluminitée
Placa, acero aluminizado

| art. | Ø cm. | cm. | pcs/pz | € |
|----------|-------|-------|--------|--------|
| 41752-08 | 14 | 60x40 | 8 | 62,31 |
| 41752-12 | 12 | 60x40 | 12 | 69,14 |
| 41752-24 | 12 | 60x80 | 24 | 120,50 |



PP
SS

Dough scraper, flexible

Tagliapasta flessibile
Abstecher, flexibele
Raclette flexible
Cortapastas flexible

| art. | cm. | € |
|----------|--------|------|
| 18501-02 | 12x9,5 | 9,55 |



PP
SS

Dough scraper

Tagliapasta
Abstecher
Raclette
Cortapastas

| art. | cm. | € |
|----------|---------|-------|
| 18501-01 | 12x16 | 13,17 |
| 18501-03 | 13,5x10 | 9,35 |
| 18501-04 | 12x9,5 | 8,24 |



PP
SS

Dough scraper

Raschia
Teigschäber
Raclette
Rasqueta

| art. | cm. | € |
|----------|---------|-------|
| 18501-05 | 11x19,5 | 13,27 |



PP
SS

Dough scraper

Raschia
Teigschäber
Raclette
Rasqueta

| art. | cm. | € |
|----------|------|-------|
| 18502-18 | 18x9 | 12,66 |



PP
SS

Dough scraper

Raschia
Teigschäber
Raclette
Rasqueta

| art. | cm. | € |
|----------|-------|------|
| 18503-12 | 12x10 | 9,55 |



PP
SS

Dough scraper

Raschia
Teigschäber
Raclette
Rasqueta

| art. | cm. | € |
|----------|--------|------|
| 18504-15 | 15x7,5 | 7,04 |



PP
SS

Dough scraper

Raschia
Teigschäber
Raclette
Rasqueta

| art. | cm. | € |
|----------|------|------|
| 18520-15 | 15x6 | 6,43 |



PA+
plus

Pizza ladle, flat bottom

Mestolo pizza, fondo piatto
Schöpföffel, flachboden
Louche fond plat
Cacillo fondo plano

| art. | Ø cm. | l. cm. | € |
|----------|-------|--------|------|
| 12968-10 | 10 | 27 | 9,55 |



PS

Dough cutter

Tagliapasta
Teigschäber
Raclette
Rascador

| art. | cm. | € |
|----------|-------|-------|
| 47621-11 | 10x24 | 10,35 |

Shock and scratchproof material. Do not use on heat sources. – Materiale antiurto e antigraffio. Non usare su fonti di calore.



PS

Dough cutter

Tagliapasta
Teigschäber
Raclette
Rascador

| art. | cm. | € |
|----------|-----------|-------|
| 47621-12 | 13,5x14,5 | 11,36 |

Shock and scratchproof material. Do not use on heat sources. – Materiale antiurto e antigraffio. Non usare su fonti di calore.



PE

Dough box

Contentore per impasti
Behälter für Pizzateig
Réceptient à pétrissage
Contenedor para masa de pizza

| art. | cm. | lt. | € |
|----------|-----------|-----|-------|
| 41762-07 | 60x40x7,5 | 14 | 14,87 |
| 41762-09 | 60x40x9,5 | 19 | 16,58 |
| 41762-13 | 60x40x13 | 26 | 19,90 |



PE

Cover for dough box

Coperchio per contenitore
Deckel für Pizzateig-Behälter
Couvercle pour réceptient à pétrissage
Tapa para contenedor

| art. | cm. | € |
|----------|-------|-------|
| 41763-00 | 60x40 | 12,26 |



COFFEE SHOP CAFFETTERIA

BAR HAPPY HOUR





Set 2 double wall espresso cups
Set 2 tazze espresso doppia parete
Set 2 Doppelwandigen Espressotassen
Set 2 tasses espresso double paroi
Juego 2 tazas doble pared espresso

| art. | Ø cm. | h. cm. | ml. | € |
|----------|-------|--------|-----|-------|
| 41202-01 | 6 | 7,5 | 100 | 13,07 |

Borosilicate glass. – Vetro borosilicato.



Set 2 double wall capuccino cups
Set 2 tazze capuccino doppia parete
Set2 Doppelwandigen Cappuccinotassen
Set 2 tasses capuccino double paroi
Juego 2 tazas doble pared capuchino

| art. | Ø cm. | h. cm. | ml. | € |
|----------|-------|--------|-----|-------|
| 41202-02 | 7,5 | 9,5 | 200 | 17,89 |

Borosilicate glass. – Vetro borosilicato.



Teapot with infuser
Teiera con infusore
Teekanne mit Infuser
Théière avec infuseur
Tetera con infusor

| art. | Ø cm. | h. cm. | ml. | € |
|----------|-------|--------|-----|-------|
| 41203-01 | 14 | 12 | 900 | 23,82 |

Borosilicate glass. Stainless steel infuser. – Vetro borosilicato. Infusore inox.



Pour over coffee maker with filter
Caffettiera pour over con filtro
Pour Over Kaffeebereiter mit Filter
Cafetière pour over avec filtre
Cafetera pour over con filtro

| art. | Ø cm. | h. cm. | ml. | € |
|----------|--------|--------|-----|-------|
| 41203-11 | 8,5-11 | 21 | 600 | 34,97 |

Borosilicate glass. Bamboo collar. St/steel filter.
Vetro borosilicato. Collo bambù. Filtro inox.



Nitro Whip

Sifone nitro
Nitrobereiter
Siphon à nitro
Sifón para Nitro

| art. | lt. | des. | € |
|----------|-----|-----------------------|--------|
| 41452N10 | 1 | Whip/Sifone | 281,60 |
| 41452N16 | - | 16 chargers/ricariche | 29,75 |

Nitro Brew is on one of the fastest growing trends in the coffee business. Offer Nitro Coffee, Nitro Tea, and Nitro Cocktails to delight your guests table/barside. Adding Nitrogen (N2) to cold brew coffee and cocktails initiates a spectacular cascading effect, making the beverage unique, attractive, and personal. Nitrogen creates a velvety creamy texture and a long lasting foamy head for brews and cocktails. – Infusi Nitro è una delle tendenze in rapida crescita nel settore del caffè. Offri Nitro Caffè, Nitro Te e Nitro Cocktails per deliziare i tuoi ospiti. Aggiungendo l'azoto (N2) per preparare caffè e cocktail a freddo, viene avviato uno spettacolare effetto a cascata, rendendo la bevanda unica, attraente e personale. L'azoto crea una consistenza vellutata e cremosa e una spuma di lunga durata per infusi e cocktail.



Set of 10 stencils, plastic

Kit 10 mascherine, plastica
Satz 10 Masken, kunststoff
Set 10 pcs masques, plastique
Juego 10 máscaras, plástico

| art. | Ø cm. | h. cm. | lt. | € |
|----------|-------|--------|------|---|
| 47859-01 | 10 | 16 | 0,25 | - |



Set of 10 stencils, plastic

Kit 10 mascherine, plastica
Satz 10 Masken, kunststoff
Set 10 pcs masques, plastique
Juego 10 máscaras, plástico

| art. | Ø cm. | € |
|----------|-------|---|
| 47859-02 | 10 | - |



Set of 4 stencils, plastic

Kit 4 mascherine, plastica
Satz 4 Masken, kunststoff
Set 4 pcs masques, plastique
Juego 4 máscaras, plástico

| art. | Ø cm. | € |
|----------|-------|---|
| 47859-03 | 10 | - |



Cocoa duster kit

Kit spargicacao
Kakaostreuer-Set
Set glacière à cacao
Juego dosificador cacao

| art. | Ø cm. | h. cm. | € | |
|----------|-------|--------|-------|--|
| 42923-07 | 6,5 | 13 | 33,37 | |



Cocoa dredger

Spargicacao
Kakaostreuer
Saupoudreuse à cacao
Coctelera de cacao

| art. | Ø cm. | h. cm. | ml. | € |
|----------|-------|--------|-----|-------|
| 41607-00 | 5,5 | 7,5 | 160 | 10,95 |



Sugar pourer

Spargizucchero
Zuckerstreuer
Saupoudreuse à sucre
Dispensador de azúcar

| art. | Ø cm. | Ø mm. | ml. | € |
|----------|-------|-------|-----|-------|
| 47023-01 | 7 | 1,5 | 300 | 10,45 |
| 47023-02 | 7 | 2,5 | 300 | 10,45 |
| 47023-03 | 7 | 5 | 300 | 10,45 |
| 47023-04 | 7 | mesh | 300 | 12,06 |



Sugar pourer

Spargizucchero
Zuckerstreuer
Saupoudreuse à sucre
Dispensador azúcar

| art. | Ø cm. | h. cm. | ml. | € |
|----------|-------|--------|-----|------|
| 41525-01 | 8 | 15 | 250 | 6,23 |



Sugar pourer

Spargizucchero
Zuckerstreuer
Saupoudreuse à sucre
Dispensador azúcar

| art. | Ø cm. | h. cm. | ml. | € |
|----------|-------|--------|-----|------|
| 42920-02 | 7,5 | 13,5 | 320 | 4,72 |



Sugar pourer

Spargizucchero
Zuckerstreuer
Saupoudreuse à sucre
Dispensador azúcar

| art. | Ø cm. | h. cm. | ml. | € |
|----------|-------|--------|-----|------|
| 41645-00 | 7,5 | 17 | 320 | 7,54 |



Honey/cream dispenser

Dosatore miele/cremiera
Sahne-/Honigkännchen
Doseur pour miel/lait
Dosificador para miel/leche

| art. | Ø cm. | h. cm. | ml. | € |
|----------|-------|--------|-----|-------|
| 41525-00 | 8,5 | 13,5 | 300 | 14,57 |



Milk frothing thermometers, 3 pcs

Termometri latte/barista, 3 pz
Mich-Thermometer, 3 Stk
Thermomètres à lait, 3 pièces
Termómetros leche, 3 pz

| art. | Ø cm. | scala | range | € |
|----------|-------|-------|-----------|-------|
| 49709-03 | 4,5 | 1°C | -10+110°C | 26,33 |

Red, green and blue, to easily identify different types of milk used, to avoid cross-contamination. Stem 175 mm. – Rosso, verde e blu, per identificare facilmente i diversi tipi di latte utilizzati, per evitare la contaminazione incrociata. Stelo 175 mm.



Milk pot with lid

Lattiera con coperchio
Milchgießer mit Deckel
Pot à lait avec couvercle
Jarra leche con tapa

| art. | lt. | € |
|----------|------|-------|
| 66303-01 | 0,15 | 29,15 |
| 66303-03 | 0,30 | 34,57 |
| 66303-06 | 0,60 | 48,44 |



Cappuccino milk pot

Lattiera cappuccino
Capuccino-Milchkanne
Pot à cappuccino
Jarra cappuccino

| art. | lt. | € |
|----------|-----|-------|
| 66307-06 | 0,6 | 40,30 |
| 66307-09 | 0,9 | 46,43 |
| 66307-12 | 1,2 | 54,57 |



Spoon holder

Porta cucchiaini
Kaffeelöffelbehälter
Porte cuillères
Porta cucharas

| art. | Ø cm. | h. cm. | € |
|----------|-------|--------|-------|
| 66313-03 | 6 | 9 | 20,10 |



SS

Straw holder

Porta cannuce
Röhrchenbehälter
Porte chalumaux
Porta pajitas

| art. | Ø cm. | h. cm. | € |
|----------|-------|--------|-------|
| 66313-06 | 8 | 12 | 28,14 |



NEW

SS

W

Milk & sugar set 5 pcs

Latte & zucchero, set 5 pezzi
Milch- und Zucker-Set 5 Stk
Set lait et Sucre, 5 pièces
Set leche y azúcar 5 piezas

| art. | dim. cm. | € |
|----------|------------|-------|
| 41537-00 | 19x10x10,5 | 40,70 |

Stainless steel PTFE coated. Acacia wood.



NEW

SS

QD

Milk jug

Lattiera
Milchkanne
Pot à lait
Jarra leche

| art. | Ø cm. | h. cm. | lt. | € |
|----------|-------|--------|------|-------|
| 41537-03 | 8,0 | 10,0 | 0,35 | 23,52 |
| 41537-06 | 9,0 | 11,5 | 0,60 | 28,54 |
| 41537-08 | 10,5 | 13,0 | 0,80 | 37,89 |

PTFE coated.



SS

Sugar packet holder

Portabustine zucchero
Zuckertütenschale
Porte-sachet de sucre
Porta sobres de azúcar

| art. | dim. cm. | € |
|----------|----------|-------|
| 66374-00 | 13x6x4 | 19,30 |

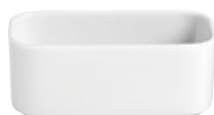

PR

Sugar packet holder

Portabustine zucchero
Zuckertütenschale
Porte-sachet de sucre
Porta sobres de azúcar

| art. | dim. cm. | € |
|----------|----------|------|
| 67303-64 | 11x6x4 | 7,04 |



Sugar packet holder

Portabustine zucchero
Zuckertütenschale
Porte-sachet de sucre
Porta sobres de azúcar

| art. | dim. cm. | col. | € |
|----------|-----------|------|------|
| 44104-01 | 8,5x6,5x5 | ● | 1,61 |
| 44104-02 | 8,5x6,5x5 | ○ | 1,61 |



AY

Tea-box

Scatola portabustine thè
Teebox
Boîte à sachets de thé
Caja para bolsitas de tè

| art. | dim. cm. | € |
|----------|----------|-------|
| 41614-22 | 22x17x9 | 35,48 |



W

Tea-box

Scatola portabustine thè
Teebox
Boîte à sachets de thé
Caja para bolsitas de tè

| art. | dim. cm. | € |
|----------|-----------|-------|
| 41614-33 | 33,5x20x9 | 42,11 |
| 41614-35 | 31x28x9 | 47,24 |



W

Tea-box

Scatola portabustine thè
Teebox
Boîte à sachets de thé
Caja para bolsitas de tè

| art. | dim. cm. | € |
|----------|-----------|-------|
| 41614-34 | 33,5x20x9 | 44,12 |
| 41614-36 | 31x28x9 | 47,24 |



PMMA

Box With Lid

Contentitore con coperchio
Behälter mit Deckel
Boîte avec couvercle
Recipiente con tapa

| art. | dim. cm. | € |
|----------|---------------|--------|
| 41472-25 | 27,5x10,5x9,5 | 109,75 |

Single compartment 8,5x8 cm.
Singolo scomparto 8,5x8 cm.



PMMA

Napkin holder

Portatovaglioli
Serviettenhalter
Porte serviettes
Servilletero

| art. | dim. cm. | € |
|----------|----------|-------|
| 41472-12 | 18x6x10 | 29,25 |



PMMA

Napkin holder

Portatovaglioli
Serviettenhalter
Porte serviettes
Servilletero

| art. | dim. cm. | € |
|----------|----------|-------|
| 41472-13 | 18x6x11 | 29,25 |



SS

Napkin holder
Portatovaglioli
Serviettenhalter
Porte serviettes
Servilletero

| art. | dim. cm. | € |
|----------|----------|------|
| 66391-00 | 10x3x8 | 7,84 |



SS

Napkin holder
Portatovaglioli
Serviettenhalter
Porte serviettes
Servilletero

| art. | dim. cm. | € |
|----------|----------|-------|
| 41602-00 | 17x3x7 | 11,86 |



SS

Napkin holder
Portatovaglioli
Serviettenhalter
Porte serviettes
Servilletero

| art. | dim. cm. | € |
|----------|-------------|-------|
| 41601-17 | 8,5x11x12,5 | 19,80 |



Napkin holder, chrome plated wire
Portatovaglioli in filo cromato
Serviettenhalter, Metall verchromt
Porte-serviettes en fil chromé
Servilletero en hilo cromado

| art. | dim. cm. | € |
|----------|-----------|-------|
| 41617-05 | 19x19x6,5 | 12,16 |



Napkin holder, chrome plated wire
Portatovaglioli in filo cromato
Serviettenhalter, Metall verchromt
Porte-serviettes en fil chromé
Servilletero en hilo cromado

| art. | dim. cm. | € |
|----------|----------|-------|
| 41617-15 | 19x19x19 | 19,90 |



Napkin holder, chrome plated wire
Portatovaglioli in filo cromato
Serviettenhalter, Metall verchromt
Porte-serviettes en fil chromé
Servilletero en hilo cromado

| art. | dim. cm. | € |
|----------|-----------|-------|
| 41618-14 | 14x14x6,5 | 11,66 |



Cash tray, 18 Cr s/s
Vassoio conto, inox 18 Cr
Rechnungstablent, Edelstahl 18 Cr
Plateau porte-monnaie, inox 18 Cr
Bandeja cuentas, acero 18 Cr

| art. | dim. cm. | € |
|----------|----------|-------|
| 66318-19 | 19x14 | 10,65 |
| 66318-22 | 22x15 | 11,56 |



SS

Pastry stand 2-tier
Alzata dolci, 2 piani
Gebäckständer, 2-stufig
Serviteur muet 2 étages
Soporte dulces 2 niveles

| art. | Ø cm. | h. cm. | € |
|----------|-------|--------|-------|
| 66339-02 | 12/16 | 20 | 75,48 |



Serving stand, chrome plated
Alzata cromata
Serviergestell, Metall hartverchromt
Présentoir chromé
Soporte platos cromado

| art. | dim. cm. | € |
|----------|--------------|-------|
| 42962-26 | 18,5x15,5x26 | 41,31 |

For 3 plates max. Ø 17 cm, inside Ø 10,5 cm.
Per 3 piatti max. Ø 17 cm, interno Ø 10,5 cm.



Serving stand

Alzata
Serviergestell
Présentoir
Soporte platos

| art. | dim. cm. | € |
|----------|--------------|-------|
| 42962C26 | 18,5x15,5x26 | 45,23 |

For 3 plates max. Ø 17 cm, inside Ø 10,5 cm.
Per 3 piatti max. Ø 17 cm, interno Ø 10,5 cm.



W

Coffee set 4 pieces

Servizio caffè 4 pezzi
Kaffeaset 4 Stk
Service à café 4 pièces
Servicio de café 4 piezas

| art. | dim. cm. | € |
|----------|-------------|-------|
| 41206-03 | 25x18,7x2,5 | 17,89 |

Acacia wood. – Acacia.



Serving stand 2-tier

Alzata 2 piani
Serviergestell, 2-stufig
Présentoir 2 étages
Soporte 2 niveles

| art. | dim. cm. | € |
|----------|----------|--------|
| 41208-06 | 31x17x38 | 103,41 |

Black metal frame with non-slip feet, 2 baskets 29x16x7 cm, 2 acacia wood boards 28,5x15,5x1,5 cm. – Struttura in metallo nero con piedini antiscivolo, 2 cesti cm 29x16x7, 2 assi in legno di acacia cm 28,5x15,5x1,5.



Serving stand 2-tier

Alzata 2 piani
Serviergestell, 2-stufig
Présentoir 2 étages
Soporte 2 niveles

| art. | Ø cm. | h. cm. | € |
|----------|-------|--------|-------|
| 41208-02 | 22/26 | 48 | 67,84 |

Wooden handle, metal black baskets Ø 22 H 6 cm and Ø 26 H 8 cm. – Manico legno, cesti in metallo nero Ø 22 H 6 cm e Ø 26 H 8 cm.



SS

Cake stand

Alzata torta
Tortenplatte
Gueridon pâtissier
Pedestal para tartas

| art. | Ø cm. | h. cm. | € |
|----------|-------|--------|---|
| 41538-30 | 30 | 5 | - |



SS

Cake stand

Alzata torta
Tortenplatte
Gueridon pâtissier
Pedestal para tartas

| art. | Ø cm. | h. cm. | € |
|----------|-------|--------|-------|
| 47099-30 | 30 | 10 | 59,60 |



SS

Swivel cake stand

Alzata torta girevole
Tortenplatte drehbar
Gueridon pâtissier tournante
Pedestal giratorio para tartas

| art. | Ø cm. | h. cm. | € |
|----------|-------|--------|-------|
| 47101-31 | 30,5 | 9 | 75,88 |

Rotating plate. Fits to: 41414-31.
Piatto rotante. Per art.: 41414-31.



MF

Cake stand

Alzata torta
Tortenplatte
Gueridon pâtissier
Pedestal para tartas

| art. | dim. cm. | € |
|----------|----------|-------|
| 44874-08 | 31x31x8 | 53,97 |
| 44874-16 | 31x31x16 | 65,83 |



PS

Dome cover

Cloche
Abdeckhaube
Cloche
Campana

| art. | Ø cm. | h. cm. | € |
|----------|-------|--------|-------|
| 41414-30 | 30 | 9,5 | 10,35 |

Fits to/Per art.: 44845-31, 47101-31, 44873-08, 44873-16.



MF

Cake tray

Piatto torta
Tortenplatte
Plat gâteau
Bandeja pasteles

| art. | Ø cm. | h. cm. | € |
|----------|-------|--------|-------|
| 44845-31 | 31,0 | 3,5 | 31,05 |

With non-slip feet. With carved edge fixing the cover. – Con piedini antiscivolo. Con bordo fissacoperchio.



MF

Cake stand

Alzata torta
Tortenplatte
Gueridon pâtissier
Pedestal para tartas

| art. | Ø cm. | h. cm. | € |
|----------|-------|--------|-------|
| 44873-08 | 30,5 | 9 | 48,34 |

With non-slip feet. With carved edge fixing the cover. – Con piedini antiscivolo. Con bordo fissacoperchio.



MF

Cake stand

Alzata torta
Tortenplatte
Gueridon pâtissier
Pedestal para tartas

| art. | Ø cm. | h. cm. | € |
|----------|-------|--------|-------|
| 44873-16 | 30,5 | 17 | 60,80 |

With non-slip feet. With carved edge fixing the cover. – Con piedini antiscivolo. Con bordo fissacoperchio.



PC

Dome cover

Campana
Haube
Cloche
Campana

| art. | Ø cm. | h. cm. | € |
|----------|-------|--------|-------|
| 41414-21 | 21 | 17 | 21,61 |

Fits to/Per art.: 44474-24, 44474-25.



PC

Dome cover

Campana
Haube
Cloche
Campana

| art. | Ø cm. | h. cm. | € |
|----------|-------|--------|-------|
| 41414-31 | 30 | 22 | 42,71 |

Fits to/Per art.: 41586-33, 41587-32, 44475-79, 44845-31, 44873-08, 44873-16, 47101-31, 44474-33, 44474-34.



PC

Dome cover

Campana
Haube
Cloche
Campana

| art. | Ø cm. | h. cm. | € |
|----------|-------|--------|-------|
| 41414-36 | 36 | 27 | 71,96 |

Fits to/Per art.: 44474-38, 44474-39, 44470-38.



PC

Dome cover

Campana
Haube
Cloche
Campana

| art. | Ø cm. | h. cm. | € |
|----------|-------|--------|--------|
| 41413-30 | 30 | 40 | 124,92 |

Fits to/Per art.: 44845-31, 44873-08, 44873-16, 44474-33, 44474-34.





W



Cake stand
Alzata torta
Tortenplatte
Gueridon pâtissier
Pedestal para tartas

| art. | Ø cm. | h. cm. | € |
|----------|-------|--------|-------|
| 44474-09 | 9,5 | 7 | 9,85 |
| 44474-13 | 13,0 | 9 | 14,47 |

Acacia wood. – Legno d'acacia.



NEW

PC

Dome cover
Cloche
Abdeckehaube
Cloche
Campana

| art. | Ø cm. | h. cm. | fits/per | € |
|----------|-------|--------|----------|------|
| 41414-10 | 10 | 10 | 44474-13 | 7,94 |



W



Cake stand
Alzata torta
Tortenplatte
Gueridon pâtissier
Pedestal para tartas

| art. | Ø cm. | h. cm. | fits/per | € |
|----------|-------|--------|----------|-------|
| 44474-24 | 24 | 8 | 41414-21 | 24,22 |
| 44474-33 | 33 | 8 | 41414-31 | 40,80 |
| 44474-38 | 38,5 | 8 | 41414-36 | 50,15 |

Acacia wood. – Legno d'acacia.



W



Cake stand
Alzata torta
Tortenplatte
Gueridon pâtissier
Pedestal para tartas

| art. | Ø cm. | h. cm. | fits/per | € |
|----------|-------|--------|----------|-------|
| 44474-25 | 24 | 16 | 41414-21 | 31,66 |
| 44474-34 | 33 | 16 | 41413-30 | 54,77 |
| 44474-39 | 38,5 | 16 | 41414-36 | 63,32 |

Acacia wood. – Legno d'acacia.



W



Cake plate
Piatto torta
Tortenplatte
Plat à gâteau
Plato pastel

| art. | Ø cm. | h. cm. | € |
|----------|-------|--------|---|
| 41445-11 | 30 | 2,0 | - |

Oak. With non-slip feet.

Quercia. Con piedini antiscivolo.



PS

Dome cover
Cloche
Abdeckehaube
Cloche
Campana

| art. | Ø cm. | h. cm. | € |
|----------|-------|--------|------|
| 41420-30 | 30 | 11,5 | 9,55 |

Fits to / Per art.: 41445-11, 44470-31.





PS

Dome cover

Cloche
Abdeckhaube
Cloche
Campana

| art. | Ø cm. | h. cm. | € |
|----------|-------|--------|---|
| 41420-31 | 30 | 11,5 | - |

Chrome plated knob. – Pomolo cromato.



B

PS

Tray with cover

Tagliere con cloche
Servierbrett mit Abdeckhaube
Planche avec cloche
Tabla con campana

| art. | dim. cm. | € |
|----------|-----------|-------|
| 41416-24 | 24x18,5x8 | 12,36 |



B

PS

Tray with cover

Tagliere con cloche
Servierbrett mit Abdeckhaube
Planche avec cloche
Tabla con campana

| art. | dim. cm. | € |
|----------|------------|-------|
| 41416-32 | 32x16,5x11 | 16,38 |



B

PS

Tray with cover

Tagliere con cloche
Servierbrett mit Abdeckhaube
Planche avec cloche
Tabla con campana

| art. | Ø cm. | h. cm. | € |
|----------|-------|--------|-------|
| 41416-20 | 20,5 | 10,0 | 14,37 |



W

SAN

Tray with cover

Tagliere con cloche
Servierbrett mit Abdeckhaube
Planche avec cloche
Tabla con campana

| art. | Ø cm. | h. cm. | € |
|----------|-------|--------|-------|
| 41416-25 | 25 | 13,5 | 18,39 |



W

SAN

Tray with cover

Tagliere con cloche
Servierbrett mit Abdeckhaube
Planche avec cloche
Tabla con campana

| art. | dim. cm. | € |
|----------|------------|-------|
| 41416-28 | 28x14x11,5 | 16,38 |



W

Tray with dome cover

Vassoio con campana
Tablett mit Haube
Plat avec cloche
Bandeja con campana

| art. | Ø cm. | h. cm. | € |
|----------|-------|--------|-------|
| 41416-18 | 18,5 | 24,5 | 60,80 |

Glass cover Ø 16 H 22,5 cm.

Cloche in vetro Ø 16 H 22,5 cm.



NEW

SS

PS

Tray with cover

Vassoio con cloche
Tablett mit Haube
Plateau avec cloche
Bandeja con campana

| art. | dim. cm. | € |
|----------|-----------|-------|
| 41422-42 | 42x31x8,5 | 34,47 |



NEW

SS

PS

Tray with cover

Vassoio con cloche
Tablett mit Haube
Plateau avec cloche
Bandeja con campana

| art. | Ø cm. | h. cm. | € |
|----------|-------|--------|-------|
| 41422-38 | 38 | 12,0 | 35,07 |



NEW
SS
SAN

Tray with cover
Vassoio con cloche
Tablett mit Haube
Plateau avec cloche
Bandeja con campana

| art. | Ø cm. | h. cm. | € |
|----------|-------|--------|-------|
| 41422-27 | 27 | 12,5 | 20,40 |



NEW
SS
SAN

Tray with cover
Vassoio con cloche
Tablett mit Haube
Plateau avec cloche
Bandeja con campana

| art. | dim. cm. | € |
|----------|--------------|-------|
| 41422-30 | 30x15,5x10,5 | 22,21 |



NEW
SS
PS

Tray with cover
Vassoio con cloche
Tablett mit Haube
Plateau avec cloche
Bandeja con campana

| art. | dim. cm. | € |
|----------|----------|-------|
| 41422-25 | 25x19x7 | 14,67 |



NEW
SS
PS

Tray with cover
Vassoio con cloche
Tablett mit Haube
Plateau avec cloche
Bandeja con campana

| art. | dim. cm. | € |
|----------|----------|-------|
| 41422-33 | 33x17x10 | 14,67 |



PMMA

Display case
Vetrina brioches
Vitrine für Brioches
Vitrine brioches
Vitrina brioches

| art. | dim. cm. | € |
|----------|----------|--------|
| 41472-32 | 37x31x31 | 307,43 |

1 door, 3 shelves, H 10 cm.
1 porta, 3 piani H 10 cm.

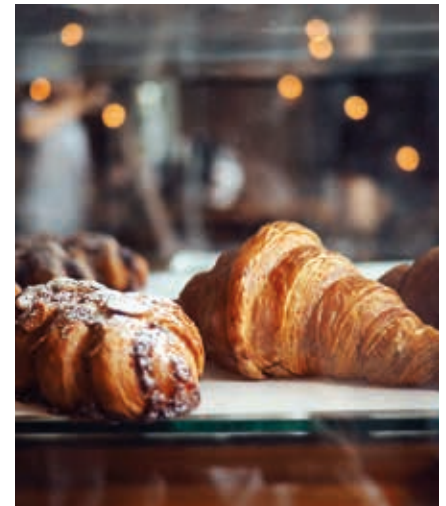

~~SS~~
AY
PP

Sweet box
Contenitore universale
Universalbox
Boîte à comptoir
Exibidor

| art. | dim. cm. | € |
|----------|------------|-------|
| 47090-23 | 23x14,5x15 | 22,81 |



NEW
PS

Showcase
Vetrina da banco
Vitrine für Verkaufstheke
Vitrine à comptoir
Vitrina

| art. | dim. cm. | € |
|----------|----------|-------|
| 47092-01 | 40x30x18 | 42,01 |

Double side opening. – Apertura doppio fronte.



NEW
PS

Showcase, 2-tier
Vetrina da banco, 2 piani
Vitrine für Verkaufstheke, doppeldecker
Vitrine à comptoir, 2 étages
Vitrina, doble

| art. | dim. cm. | € |
|----------|----------|-------|
| 47092-02 | 45x30x43 | 97,49 |

Double side opening. – Apertura doppio fronte.

ICE CREAM GELATERIA

BAR HAPPY HOUR





SS

Ice cream container

Bacinella per gelato
Eisbehälter
Réceptient à glace
Cubeta helado

| art. | dim. cm. | lt. | € |
|----------|----------|-----|-------|
| 41487-12 | 26x16x12 | 3,5 | 23,62 |
| 41487-15 | 26x16x15 | 4,1 | 30,95 |
| 41487-17 | 26x16x17 | 4,5 | 32,06 |



SS

Ice cream container

Bacinella per gelato
Eisbehälter
Réceptient à glace
Cubeta helado

| art. | dim. cm. | lt. | € |
|----------|------------|-----|-------|
| 41471-12 | 36x16,5x12 | 5,0 | 28,74 |
| 41471-15 | 36x16,5x15 | 6,5 | 40,10 |
| 41471-17 | 36x16,5x17 | 7,5 | 47,24 |



SS

Ice cream container

Bacinella per gelato
Eisbehälter
Réceptient à glace
Cubeta helado

| art. | dim. cm. | lt. | € |
|----------|----------|-----|-------|
| 41486-08 | 36x25x8 | 5 | 26,93 |
| 41486-12 | 36x25x12 | 8 | 28,94 |
| 41486-15 | 36x25x15 | 10 | 46,03 |



PC

Ice cream container

Bacinella per gelato
Eisbehälter
Réceptient à glace
Cubeta helado

| art. | dim. cm. | lt. | € |
|----------|------------|-----|------|
| 41431-12 | 36x16,5x12 | 5,4 | 8,24 |



PC

Ice cream container

Bacinella per gelato
Eisbehälter
Réceptient à glace
Cubeta helado

| art. | dim. cm. | lt. | € |
|----------|----------|-----|-------|
| 41431-08 | 36x25x8 | 5,0 | 11,16 |



PMMA

Lid for ice cream container

Coperchio per bacinella gelato
Deckel für Eisbehälter
Couvercle pour réceptient à glace
Tapa para cubeta helado

| art. | dim. cm. | € |
|----------|----------|-------|
| 41471-00 | 36x16,5 | 11,66 |



PC

Lid for ice cream container

Coperchio per bacinella gelato
Deckel für Eisbehälter
Couvercle pour réceptient à glace
Tapa para cubeta helado

| art. | dim. cm. | € |
|----------|----------|-------|
| 41486-00 | 36x16,5 | 11,46 |
| 41486-01 | 36x25 | 12,16 |



SS

Ice cream basin

Carapina
Eisbehälter
Réceptient à glace
Cubeta helados

| art. | Ø cm. | h. cm. | lt. | € |
|----------|-------|--------|-----|-------|
| 41489-20 | 20 | 25 | 7,3 | 68,24 |



SS

Ice cream server

Spatola gelato carapina
Eisspachtel
Palette à glace
Paleta helados

| art. | col. | € |
|----------|------|------|
| 41475-20 | ○ | 9,95 |



SS

Ice cream server

Spatola gelato
Eisspachtel
Palette à glace
Paleta helados

| art. | l. cm. | col. | € |
|----------|--------|------|------|
| 41475-00 | 27 | ○ | 8,44 |
| 41475-01 | 27 | ● | 8,44 |
| 41475-03 | 27 | ● | 8,44 |
| 41475-04 | 27 | ● | 8,44 |
| 41475-05 | 27 | ● | 8,44 |



Ice-dipper

Spatola gelato
Eisdipper
Cuillère à glace
Cuchara helados

| art. | Ø mm. | lt. | € |
|----------|-------|------|------|
| 41468-20 | 55 | 1/20 | 9,55 |
| 41468-24 | 50 | 1/24 | 9,55 |

With liquid heat conductor in the handle.
Con liquido conduttore nel manico.



Ice-dipper

Spatola gelato
Eisdipper
Cuillère à glace
Cuchara helados

| art. | Ø mm. | lt. | € |
|----------|-------|------|-------|
| 41469-20 | 55 | 1/20 | 11,46 |
| 41469-24 | 50 | 1/24 | 11,46 |

With liquid heat conductor in the handle.
Con liquido conduttore nel manico.



SS

Ice cream scoop
Porzionatore
Eisportionierer
Cuillère à glace
Racionador de helado

| art. | Ø mm. | lt. | € |
|----------|-------|------|-------|
| 41476-50 | 50 | 1/24 | 22,91 |

Non slip handle. – Manico antiscivolo.



SS

Ice cream scoop
Porzionatore
Eisportionierer
Cuillère à glace
Racionador de helado

| art. | Ø mm. | lt. | € |
|----------|-------|-------|-------|
| 41473-31 | 30 | 1/100 | 17,69 |
| 41473-39 | 38 | 1/65 | 17,69 |
| 41473-44 | 43 | 1/50 | 17,69 |
| 41473-50 | 50 | 1/24 | 17,69 |
| 41473-56 | 55 | 1/20 | 18,99 |
| 41473-62 | 60 | 1/14 | 18,99 |
| 41473-66 | 66 | 1/12 | 18,99 |



SS

Oval ice cream scoop
Porzionatore ovale
Eisportionierer, oval
Cuillère à glace ovale
Racionador de helado oval

| art. | Ø mm. | lt. | € |
|----------|-------|------|-------|
| 41474-00 | 60 | 1/30 | 21,00 |



SS

Triangle ice cream scoop
Porzionatore triangolare
Eisportionierer, dreieckig
Cuillère à glace triangle
Racionador de helado triangular

| art. | lt. | € |
|----------|------|-------|
| 41474-02 | 1/30 | 18,29 |



Decorative scrapers 5 pcs
Raschietti decorativi 5 pezzi
Dekorative Schaber 5 Stk
Raclettes décoratives 5 pcs
Rasquetas decorativas 5 pz

| art. | dim. cm. | € |
|----------|----------|---|
| 41472-43 | 14,5x15 | - |

PETG.



PMMA

Counter ice cream cone holder
Porta coni da banco
Theke-Eiswaffelständer
Porte cornets à glace de comptoir
Expositor para cucuruchos

| art. | Ø mm. | dim. cm. | € |
|----------|-------|-------------|-------|
| 41472-07 | 3,5 | 21x8,5x11 | 41,51 |
| 41472-08 | 3,5 | 28,5x8,5x11 | 51,15 |



SS

Counter ice cream cone holder
Porta coni da banco
Theke-Eiswaffelständer
Porte cornets à glace de comptoir
Expositor para cucuruchos

| art. | Ø cm. | h. cm. | € |
|----------|-------|--------|-------|
| 41472-04 | 16,5 | 14 | 44,72 |



SS

Counter ice cream cone holder

Porta coni da banco
Theke-Eiswaffelständer
Porte cornets à glace de comptoir
Expositor para cucuruchos

| art. | dim. cm. | € |
|----------|------------|-------|
| 41472-01 | 20x9,5x8,5 | 41,00 |



PMMA

Flavour marker holder 10 pcs

Porta segnagusto 10 pezzi
Eisschilderhalter 10 Stk
Porte-etiquettes 10 pièces
Porta etiquetas 10 pz

| art. | mm. | € |
|----------|-------|-------|
| 41472-46 | 87x52 | 60,30 |

Labels not included. – Cartellino non incluso.



PMMA

Flavour marker 10 pcs

Segnagusto 10 pezzi
Eisschilder 10 Stk
Etiquettes 10 pièces
Etiquetas sabores 10 pz

| art. | mm. | € |
|----------|--------|-------|
| 41472-45 | 150x70 | 38,09 |



PMMA

Flavour marker 10 pcs

Segnagusto 10 pezzi
Eisschilder 10 Stk
Etiquettes 10 pièces
Etiquetas sabores 10 pz

| art. | mm. | € |
|----------|--------|-------|
| 41472-44 | 190x85 | 24,92 |



Chalkmarker

Penna a gesso liquido
Kreidestifte
Stylo à craie liquide
Marcadores de tiza líquida

| art. | col. | € |
|----------|------|------|
| 47832-01 | ● | 4,92 |
| 47832-03 | ● | - |
| 47832-04 | ● | - |
| 47832-05 | ● | 4,92 |

Writes on all non porous surfaces. Clean with water. – Scrive su tutte le superfici non porose. Pulire con acqua.



PMMA

Paper napkins holder

Porta tovaglioli
Serviettenhalter
Porte serviettes
Porta servilletas

| art. | dim. cm. | € |
|----------|----------|-------|
| 41472-12 | 18x6x10 | 29,25 |



PMMA

Paper napkins holder

Porta tovaglioli
Serviettenhalter
Porte serviettes
Porta servilletas

| art. | dim. cm. | € |
|----------|----------|-------|
| 41472-13 | 18x6x11 | 29,25 |



AY
PP

Universal box

Contentitore universale
Universalbox
Conteneur à comptoir
Recipiente universal

| art. | dim. cm. | € |
|----------|------------|-------|
| 47090-23 | 23x14,5x15 | 22,81 |



PMMA

Box with lid

Contentitore con coperchio
Behälter mit Deckel
Boîte avec couvercle
Recipiente con tapa

| art. | dim. cm. | € |
|----------|---------------|--------|
| 41472-25 | 27,5x10,5x9,5 | 109,75 |

Compartments size 8,5x8 cm. – Dimensione scomparti 8,5x8 cm.



PMMA

Waffle case

Contentitore per cialde
Waffelbehälter
Porte gaufres
Dispensador waffles

| art. | dim. cm. | € |
|----------|----------|--------|
| 41472-21 | 22x26x12 | 109,75 |



PMMA

Spoon case

Contentitore per palette
Eislöffelbehälter
Porte cuillères à glace
Dispensador cucharillas de helado

| art. | dim. cm. | € |
|----------|------------|-------|
| 41472-20 | 19x12,5x14 | 64,92 |



PMMA

Straws case

Contentitore per cannucce
Strohalmbehälter
Porte chalumeaux
Dispensador pajitas

| art. | dim. cm. | € |
|----------|----------|--------|
| 41472-22 | 26x17x22 | 112,26 |



PMMA

Cone holder, front opening

Porta coni, apertura frontale
Eiswaffelbehälter mit Frontöffnung
Porte cornets à glace, ouverture frontale
Porta cucurucho, abertura frontal

| art. | dim. cm. | € |
|----------|----------|--------|
| 41472-16 | 11x13x50 | 143,61 |



PMMA

Spoon and cup holder

Porta palette e coppette
Eislöffel und Schalenbehälter
Porte cuillères et pots
Porta cucharillas y copas

| art. | dim. cm. | € |
|----------|----------|--------|
| 41472-17 | 28x25x55 | 154,77 |



PMMA

Cone holder 6 holes with spoon drawer

Porta coni 6 fori c/porta palette
Eiswaffelspender, 6 Löcher mit Palettenhalter
Porte cornets 6 trous, porte cuillères
Porta cucurucho/cucharillas, 6 orificios

| art. | dim. cm. | € |
|----------|--------------|--------|
| 41472-18 | 25,5x18x60,5 | 241,30 |

Upper hole Ø 3,5 cm. Lower Ø 2 cm. Distance between holes Ø 4,5 cm. Removable lower drawer. – Foro superiore Ø 3,5 cm. Inferiore Ø 2 cm. Distanza tra i fori Ø 4,5 cm. Cassetto inferiore estraibile.



PMMA

Cone holder 12 holes

Porta coni 12 fori
Eiswaffelspender, 12 Löcher
Porte cornets 12 trous
Porta cucurucho 12 orificios

| art. | dim. cm. | € |
|----------|----------|---|
| 41472-24 | 33x25x50 | - |

Upper hole Ø 5,2 cm. Lower Ø 2 cm.
Foro superiore Ø 5,2 cm. Inferiore Ø 2 cm.



PMMA

Swivel cone holder 5 sections

Porta coni rotante 5 sezioni
Eiswaffelspender, drehbar, 5 Fächer
Porte cornets rotatif, 5 comp
Porta cucurucho giratorio 5 secciones

| art. | Ø cm. | h. cm. | € |
|----------|-------|--------|--------|
| 41472-23 | 25 | 50 | 268,13 |

Upper hole Ø 3,5 cm. Lower Ø 2 cm. Distance between holes Ø 4,5 cm. – Foro superiore Ø 3,5 cm. Inferiore Ø 2 cm. Distanza tra i fori Ø 4,5 cm.



PMMA

Cone holder with door

Porta coni con porta
Eiswaffelspender mit Tür
Porte cornets ouverture frontale
Porta cucurucho, abertura frontal

| art. | dim. cm. | € |
|----------|----------|---|
| 41472-19 | 33x18x50 | - |



PMMA

Horizontal cone holder with door

Porta coni orizzontale con porta
Eiswaffelspender horizontal mit Tür
Porte cornets à glace horizontal
Porta cucurucho horizontal

| art. | Ø cm. | dim. cm. | € |
|----------|-------|------------|--------|
| 41472-14 | 30 | 42x37x40,5 | 387,53 |

With removable divider. – Con divisorio estraibile.



PMMA

Revolving cones dispenser

Porta coni girevole
Eiswaffelspender, drehbar
Porte-cornets pivotant
Distributor giratorio de cucurucho

| art. | Ø cm. | h. cm. | € |
|----------|-------|--------|--------|
| 41472-15 | 24 | 78 | 474,06 |



MS

Ice cream cup

Coppa gelato
Eisbecher
Coupe à glace
Copa helado

| art. | h. cm. | lt. | U. Pack | € |
|----------|--------|------|---------|------|
| 44942-11 | 11 | 0,38 | 6 | 4,72 |



MS

Ice cream cup

Coppa gelato
Eisbecher
Coupe à glace
Copa helado

| art. | h. cm. | lt. | U. Pack | € |
|----------|--------|------|---------|------|
| 44942-10 | 16 | 0,25 | 6 | 5,63 |



SMMA

Ice cream cup

Coppa gelato
Eisbecher
Coupe à glace
Copa helado

| art. | Ø cm. | h. cm. | U. Pack | € |
|----------|-------|--------|---------|------|
| 44942-06 | 10 | 10 | 6 | 5,83 |



SMMA

Ice cream cup

Coppa gelato
Eisbecher
Coupe à glace
Copa helado

| art. | Ø cm. | h. cm. | U. Pack | € |
|----------|-------|--------|---------|---|
| 44942-07 | 9 | 19 | 6 | - |

NATURAL ELEGANT



A valid alternative to glass. Elegant and unbreakable ideals for HORECA pastry and ice cream sector. Made with high quality material that confers beside resistance also glossiness and perfect transparency. Bisphenol free. Thermal tolerance -18°C +70°C. Dishwasher safe: up to 50 washes. Can be reused several times and once disposed, they are 100% recyclable. Made in Italy.

La valida alternativa al vetro. Eleganti ed infrangibili ideali per il settore HORECA della pasticceria e gelateria. Realizzati con materiale di alta qualità che gli conferisce oltre alla resistenza anche lucidità e trasparenza. Privi di Bisfenolo. Tolleranza termica -18°C +70°C. Lavabili in lavastoviglie: fino a 50 lavaggi. Possono essere riutilizzati più volte e, una volta gettati, sono riciclabili al 100%. Prodotti made in Italy.



NEW

Cup
Coppetta
Schale
Coupe
Bol

| art. | dim. cm. | h. cm. | ml. | € |
|----------|---------------|--------|-----|-------|
| 48371-12 | 13,7x3,7x4,1 | 4,1 | 120 | 28,24 |
| 48371C12 | lid/coperchio | - | - | 17,39 |

Pcs/Conf. 100 pz.



Bowl
Coppetta
Schale
Coupe
Copa

| art. | Ø cm. | h. cm. | ml. | € |
|----------|-------|--------|-----|-------|
| 48367-10 | 7 | 5,9 | 105 | 24,12 |

Pcs/Conf. 100 pz.



Glass
Bicchierino
Glas
Verrine
Vaso

| art. | Ø cm. | h. cm. | ml. | € |
|----------|-------|--------|-----|-------|
| 48354-01 | 4 | 8,5 | 80 | 43,11 |

Pcs/Conf. 100 pz.



Glass
Bicchierino
Glas
Verrine
Vaso

| art. | dim. cm. | h. cm. | ml. | € |
|----------|---------------|--------|-----|-------|
| 48371-10 | 7,3x6,4 | 5,2 | 100 | 30,35 |
| 48371-11 | lid/coperchio | - | - | 23,62 |

Pcs/Conf. 100 pz.



Glass
Bicchierino
Glas
Verrine
Vaso

| art. | Ø cm. | h. cm. | ml. | € |
|----------|-------|--------|-----|-------|
| 48353-01 | 8,5 | 6,5 | 120 | 34,97 |

Pcs/Conf. 100 pz.



Glass

Bicchierino

Glas

Verrine

Vaso

| art. | Ø cm. | h. cm. | ml. | € |
|----------|---------------|--------|-----|-------|
| 48370-10 | 7,8 | 5,7 | 210 | 38,69 |
| 48370-11 | lid/coperchio | - | - | 23,32 |

Pcs/Conf. 100 pz.



Glass

Bicchierino

Glas

Verrine

Vaso

| art. | Ø cm. | h. cm. | ml. | € |
|----------|-------|--------|-----|-------|
| 48352-01 | 6,5 | 5,5 | 90 | 37,29 |
| 48352-02 | 7,0 | 6,7 | 135 | 41,61 |
| 48352-03 | 7,5 | 7,3 | 150 | 40,40 |

Pcs/Conf. 100 pz.



Cup

Coppetta

Schale

Coupelle

Bol

| art. | Ø cm. | h. cm. | ml. | € |
|----------|-------|--------|-----|-------|
| 48365-09 | 9 | 7,5 | 215 | 44,32 |

Pcs/Conf. 100 pz.





Cup

Coppetta
Schale
Coupelle
Bol

| art. | Ø cm. | h. cm. | ml. | € |
|----------|-------|--------|-----|-------|
| 48366-09 | 9 | 7,5 | 165 | 40,60 |

Pcs/Conf. 100 pz.



Glass

Bicchierino
Glas
Verrine
Vaso

| art. | Ø cm. | h. cm. | ml. | € |
|----------|-------|--------|-----|-------|
| 48350-01 | 4,2 | 6,5 | 65 | 23,72 |
| 48350-02 | 5,0 | 6,5 | 90 | 25,73 |
| 48350-03 | 5,5 | 7,0 | 120 | 29,25 |
| 48350-04 | 6,0 | 9,0 | 170 | 38,19 |

Pcs/Conf. 100 pz.



Glass

Bicchierino
Glas
Verrine
Vaso

| art. | dim. cm. | h. cm. | ml. | € |
|----------|----------|--------|-----|-------|
| 48351-01 | 4x4 | 5,5 | 60 | 26,13 |
| 48351-02 | 5x5 | 7,0 | 120 | 29,85 |
| 48351-03 | 5,7x5,7 | 7,3 | 175 | 35,68 |

Pcs/Conf. 100 pz.



Ice tube mold

Stampo gelato
Eisform
Moule à glace
Molde helado

| art. | ml. | € |
|----------|-----|-------|
| 41472-36 | 150 | 61,20 |

Pcs/Conf. 100 pz.



Ice cream counter display

Espositore per vetrina gelato
Ständer für Eiscremetheke
Présentoir de comptoir
Expositor helados

| art. | dim. cm. | holes/fori | € |
|----------|-----------|------------|-------|
| 41472-34 | 25x36x4,5 | 21 | 68,54 |
| 41472-35 | 16x36x4,5 | 15 | 63,92 |

For mold/Per stampo: 41472-36.



Holder for blast chiller

Supporto per abbattitore
Ständer für Schnellabkühler
Présentoir à cellule de refroidissement
Soporte para abatidor

| art. | dim. cm. | holes/fori | € |
|----------|----------|------------|-------|
| 41472-33 | 29x39x12 | 28 | 69,24 |

For mold/Per stampo: 41472-36.



Mini push up pops

Stampi mini push up pops
Mini push up pops Eisformen
Moules à mini push up pops
Mini push up pops moldes

| art. | Ø cm. | h. cm. | ml. | € |
|----------|-------|--------|-----|-------|
| 41472-37 | 4,0 | 18,8 | 90 | 59,70 |
| 41472-38 | 3,5 | 19,6 | 50 | 47,44 |

Pcs/Conf. 100 pz.



PMMA

Display for mini ice cream cones

Espositore per mini cornetti
Waffelhörnchen-Ständer
Présentoir à mini cornet à glace
Expositor mini conos helado

| art. | Ø cm. | dim. cm. | holes/fori | € |
|----------|-------|----------|------------|-------|
| 41472-41 | 1,8 | 36x16,5 | 27 | 41,91 |
| 41472-42 | 1,8 | 36x25 | 45 | 49,65 |

Suitable for all waffle minicones on the market.
Per tutti i miniconi in cialda in commercio.



Ice cream mold, silicone

Stampo gelato su stecco, silicone
Eisform, Silikon
Moule à glace, silicone
Molde helado, silicona

| art. | mm. | ml. | pcs/pz | € |
|----------|----------|-----|--------|-------|
| 41472-47 | 44x22x93 | 78 | 12 | 59,30 |

Kit 2 molds of 6 pcs with white plastic tray and 50 pcs wooden sticks. – Kit 2 stampi da 6 pz con vassoio in plastica e 50 bastoncini legno.

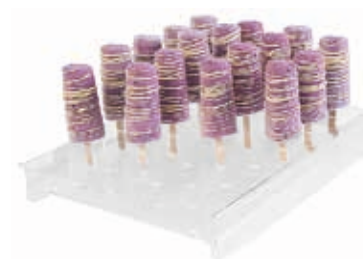

PMMA

Ice cream counter display

Espositore per vetrina gelato
Ständer für Eiscremetheke
Présentoir de comptoir
Expositor helados

| art. | dim. cm. | pcs/pz | € |
|----------|----------|--------|-------|
| 41472-48 | 36x25x5 | 24 | 69,95 |

For mold/Per stampo: 41472-47.



Tray with cover

Vassoio con coperchio
Tablett mit Deckel
Plateau avec couvercle
Bandeja con tapa Cm 59X39X8

| art. | dim. cm. | € |
|----------|----------|-------|
| 41472-50 | 59x39x8 | 90,35 |

Unbreakable, shock resistant even at very low temperatures. – Infrangibile, resistente agli urti anche a bassissime temperature.



ABS

Tempering unit

Temperatrice
Temperiergerät
Tempereuse
Templadora

| art. | Ø cm. | h. cm. | lt. | € |
|----------|-------|--------|-----|--------|
| 47698-01 | 20,5 | 21,2 | 1,7 | 572,25 |

Ideal for chocolate coatings of ice creams on sticks. Removable anodized aluminum tank.
Ideale per coperture in cioccolato di gelati e semifreddi su stecco. Vasca estraibile in alluminio anodizzato.



ABS

Tempering unit

Temperatrice
Temperiergerät
Tempereuse
Templadora

| art. | Ø cm. | h. cm. | lt. | € |
|----------|-------|--------|-----|--------|
| 47698-02 | 26 | 16 | 1,8 | 314,06 |

Allows to process tiny chocolate quantities without any waste. Removable tank.
Adatto per piccole produzioni senza sprechi. Pratica vasca estraibile.



Professional cream whipper
Sifone panna professionale
Profi-Sahnebereiter
Siphon à crème professionnel
Sifón montador de nata profesional

| art. | lt. | € |
|----------|-----|--------|
| 41451-05 | 0,5 | 168,84 |
| 41451-10 | 1,0 | 180,00 |



Cream chargers, 10-pcs set
Ricariche panna montata, conf. 10 pezzi
10-Stk. Sahnekapseln-Packung
Capsules à crème Chantilly, set 10 pièces
Cápsulas para nata, 10 piezas

| art. | € |
|----------|-------|
| 41450-AA | 11,56 |

Contains N2O under pressure.
Contiene N2O sotto pressione.



GOURMET-Cream whipper
Sifone panna
Sahnebereiter
Siphon à crème
Sifón para nata montada

| art. | lt. | € |
|----------|------|--------|
| 41458-02 | 0,25 | 210,25 |
| 41458-05 | 0,50 | 232,76 |
| 41458-10 | 1,00 | 258,39 |

Heat resistant silicone gasket. Keep warm in bain marie up to 75°C. – Guarnizione in silicone resistente al calore. Tenere a bagnomaria max. a 75°C.



THERMO-Cream whipper
Sifone termico
Thermo-Sahnebereiter
Siphon à crème, isotherme
Sifón isotérmico

| art. | lt. | € |
|----------|-----|--------|
| 41455T55 | 0,5 | 305,12 |

Double-walled, insulated bottle: keeps creations cold for 8 hours and hot for 3 hours, dishwasher-safe. – Bottiglia termica, mantiene le preparazioni in caldo fino a 3 ore e a freddo fino a 8 ore.



THERMO SPRESS-Cream whipper
Sifone termico
Thermo-Sahnebereiter
Siphon à crème, isotherme
Sifón isotérmico

| art. | h. cm. | lt. | € |
|----------|--------|-----|--------|
| 41459-10 | 35 | 1 | 498,68 |

Double-walled, insulated bottle, keeps creations cold for 8 hours and hot for 3 hours. – Bottiglia termica, mantiene le preparazioni in caldo fino a 3 ore e a freddo fino a 8 ore, lavabile in lavastoviglie.



PROFI-Cream whipper
Sifone panna
Sahnebereiter
Siphon à crème
Sifón para nata montada

| art. | lt. | € |
|----------|-----|--------|
| 41460-05 | 0,5 | 200,30 |
| 41460-10 | 1,0 | 221,60 |

Only for cold preparations.
Solo per preparazioni fredde.



Decorating tips, 3-pcs set
Bocchette, set 3 pezzi
Dekorationstüllen, 3er Set
Douilles de décoration, 3 pièces
Boquillas de decoración, 3 piezas

| art. | € |
|----------|-------|
| 41455-BC | 26,93 |



Decorating tips, 3-pcs set
Bocchette, set 3 pezzi
Dekorationstüllen, 3er Set
Douilles de décoration, 3 pièces
Boquillas de decoración, 3 piezas

| art. | € |
|----------|-------|
| 41458-23 | 37,49 |



Decorating tips and adapter
Bocchette decoro e adattatore
Dekorationstüllen-Set u. Adapter
Douilles de décoration et adaptateur
Boquillas de decoración y adaptador

| art. | € |
|----------|-------|
| 41458-24 | 36,78 |



Injector needles

Iniettori/siringhe decoro
Nadeltüllen
Aiguilles d'injection
Boquillas de aguja

| art. | € |
|----------|-------|
| 41458-21 | 58,79 |



Heat protector, silicone

Protezione in silicone
Silikonhülle
Housse en silicone
Protección de silicona

| art. | lt. | € |
|----------|-----|-------|
| 41458-50 | 0,5 | 24,62 |
| 41458-51 | 1,0 | 24,62 |



Cream chargers, PROFESSIONAL

Ricariche panna montata, PROFESSIONAL
Sahnekapseln-Packung, PROFESSIONAL
Capsules à crème Chantilly, PROFESSIONAL
Cápsulas para nata, PROFESSIONAL

| art. | pcs/pz | € |
|----------|--------|-------|
| 41455-CA | 24 | 34,77 |
| 41455-CB | 50 | 72,06 |

Filled with 8,4 g of N2O (E942, nitrous oxide).
Contenuto: 8,4 g di N2O (E942 protossido di azoto).



Funnel and sieve

Imbuto e colino
Trichter und Sieb
Entonnoir et tamis
Embudo y tamiz

| art. | € |
|----------|-------|
| 41458-11 | 85,53 |



Kit rapid infusion

Kit di infusione rapida
Rapid Infusion Set
Paquet rapid infusion
Rapid infusion set

| art. | € |
|----------|-------|
| 41458-25 | 48,74 |

Enables a liquid to be infused with different flavors in the shortest possible time. First, combine aromatic solids (e.g. herbs, spices, fruit) and a liquid (e.g. alcohol, oil, water, vinegar) in the whipper then apply pressure into it using a cream charger. – Permette di infondere un liquido con sapori diversi in tempo rapido. Unire gli aromi solidi (erbe, spezie, frutta, ecc.) con il liquido (alcohol, olio, acqua, aceto, ecc.) nel sifone ed immettere una carica per panna.



COCKTAIL BAR

BAR HAPPY HOUR



Paderno offers a wide selection of bar equipment, designed to combine easy use with efficiency and style. The tools are flanked by fascinating accessories making every moment trendy and lively. To share refined happy hours, to enjoy spectacular cocktails and long drinks, or to add style to every sort of drink.

Paderno propone un'ampia selezione di attrezzature bar, ideata per unire praticità d'utilizzo a efficienza e stile. Agli utensili si affiancano affascinanti accessori in grado di rendere trendy e vivace ogni momento. Per condividere raffinati happy hour, per gustare scenografici cocktail e long drink, oppure per aggiungere stile a ogni tipo di bevanda.



SS

Pumpkin mug, antique

Coppa zucca, antique
Kürbis-Becher, Antique
Gobelet citrouille, antique
Vaso de calabaza, antique

| art. | Ø cm. | h. cm. | ml. | € |
|----------|-------|--------|-----|-------|
| 44944A07 | 10 | 14,5 | 700 | 20,90 |



SS

Champagne glass, antique

Flute champagne, antique
Champagner Glas, Antique
Verre champagne, antique
Copa champán, antique

| art. | Ø cm. | h. cm. | ml. | € |
|----------|-------|--------|-----|-------|
| 41493A00 | 5 | 25,5 | 270 | 16,58 |



SS

Martini cup, antique

Coppa martini, antique
Martini Cocktail Glas, Antique
Verre à martini, antique
Copa martini, antique

| art. | Ø cm. | h. cm. | ml. | € |
|----------|-------|--------|-----|-------|
| 41494A00 | 12 | 16,5 | 200 | 20,10 |



SS

Margarita cup, antique

Coppa margarita, antique
Margarita Cocktail Glas, Antique
Verre à margarita, antique
Copa margarita, antique

| art. | Ø cm. | h. cm. | ml. | € |
|----------|-------|--------|-----|-------|
| 41498A00 | 10,5 | 14 | 220 | 17,29 |



SS

Cola cup, antique

Tazza Cola, antique
Cola-Becher, Antique
Gobelet Cola, antique
Taza Cola, antique

| art. | Ø cm. | h. cm. | ml. | € |
|----------|-------|--------|-----|-------|
| 44941A05 | 7,5 | 11 | 490 | 12,06 |



SS

Mint julep cup, antique

Coppa mint julep, antique
Becher für Mint Julep, Antique
Tasse à cocktail mint julep, antique
Vaso para mint julep, antique

| art. | Ø cm. | h. cm. | ml. | € |
|----------|-------|--------|-----|-------|
| 41497A05 | 8,5 | 10,5 | 380 | 16,18 |



SS

Pumpkin mug

Coppa zucca
Kürbis-Becher
Gobelet citrouille
Vaso de calabaza

| art. | Ø cm. | h. cm. | ml. | € |
|----------|-------|--------|-----|-------|
| 44944G07 | 10 | 14,5 | 700 | 20,90 |



SS

Pumpkin mug

Coppa zucca
Kürbis-Becher
Gobelet citrouille
Vaso de calabaza

| art. | Ø cm. | h. cm. | ml. | € |
|----------|-------|--------|-----|-------|
| 44944C07 | 10 | 14,5 | 700 | 20,90 |



SS

Pineapple cup
Coppa ananas
Ananas-Becher
Gobelet ananas
Vaso de piña

| art. | Ø cm. | h. cm. | ml. | col. | € |
|----------|-------|--------|-----|------|-------|
| 44945G05 | 9,5 | 20,5 | 500 | ● | 24,02 |
| 44945C05 | 9,5 | 20,5 | 500 | ● | 24,02 |

With straw. – Con cannuccia.



SS

Champagne glass
Flute champagne
Champagner Glas
Verre champagne
Copa champán

| art. | Ø cm. | h. cm. | ml. | col. | € |
|----------|-------|--------|-----|------|-------|
| 41493G00 | 5 | 25,5 | 270 | ● | 16,58 |
| 41493C00 | 5 | 25,5 | 270 | ● | 16,58 |
| 41493B00 | 5 | 25,5 | 270 | ● | 16,58 |



SS

Wine glass
Coppa vino
Wein Glas
Verre à vin
Copa vino

| art. | Ø cm. | h. cm. | ml. | col. | € |
|----------|-------|--------|-----|------|-------|
| 41499G00 | 9,4 | 20,8 | 500 | ● | 15,38 |
| 41499C00 | 9,4 | 20,8 | 500 | ● | 15,38 |
| 41499B00 | 9,4 | 20,8 | 500 | ● | 15,38 |

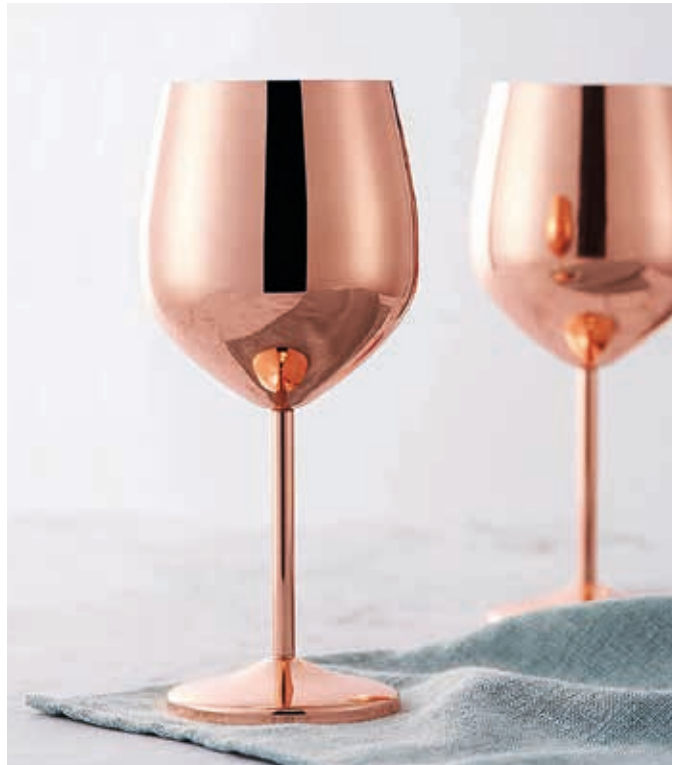

SS

Martini cup
Coppa martini
Martini Cocktail Glas
Verre à martini
Copa martini

| art. | Ø cm. | h. cm. | ml. | col. | € |
|----------|-------|--------|-----|------|-------|
| 41494G00 | 12 | 16,5 | 200 | ● | 20,10 |
| 41494C00 | 12 | 16,5 | 200 | ● | 20,10 |
| 41494B00 | 12 | 16,5 | 200 | ● | 20,10 |



SS

Margarita cup
Coppa margarita
Margarita Cocktail Glas
Verre à margarita
Copa margarita

| art. | Ø cm. | h. cm. | ml. | col. | € |
|----------|-------|--------|-----|------|-------|
| 41498G00 | 10,5 | 14 | 220 | ● | 17,29 |
| 41498C00 | 10,5 | 14 | 220 | ● | 17,29 |
| 41498B00 | 10,5 | 14 | 220 | ● | 17,29 |



SS

Moscow mule mug
Tazza moscow mule
Moscow Mule Becher
Gobelet moscow mule
Taza moscow mule

| art. | Ø cm. | h. cm. | ml. | col. | € |
|----------|-------|--------|-----|------|-------|
| 41463-01 | 8,9 | 9 | 500 | ● | 11,26 |



SS

Moscow mule mug
Tazza moscow mule
Moscow Mule Becher
Gobelet moscow mule
Taza moscow mule

| art. | Ø cm. | h. cm. | ml. | col. | € |
|----------|-------|--------|-----|------|-------|
| 41463-02 | 8,5 | 9,7 | 500 | ● | 12,06 |

Gold plated handle. – Manico dorato.



SS

Moscow mule mug, antique
Tazza moscow mule, antique
Moscow Mule Becher, Antik
Gobelet moscow mule, antique
Taza moscow mule, antiguo

| art. | Ø cm. | h. cm. | ml. | col. | € |
|----------|-------|--------|-----|------|-------|
| 41463A05 | 8,5 | 9,7 | 500 | ● | 13,07 |

Gold plated handle. – Manico dorato.



SS

Moscow mule mug
Tazza moscow mule
Moscow Mule Becher
Gobelet moscow mule
Taza moscow mule

| art. | Ø cm. | h. cm. | ml. | col. | € |
|----------|-------|--------|-----|------|-------|
| 41463G05 | 8,5 | 9,7 | 500 | ● | 10,85 |

Gold plated handle. – Manico dorato.



SS

Moscow mule mug
Tazza moscow mule
Moscow Mule Becher
Gobelet moscow mule
Taza moscow mule

| art. | Ø cm. | h. cm. | ml. | col. | € |
|----------|-------|--------|-----|------|-------|
| 41463B05 | 8,5 | 9,7 | 500 | ● | 11,76 |

Gold plated handle. – Manico dorato.



SS

Moscow mule mug
Tazza moscow mule
Moscow Mule Becher
Gobelet moscow mule
Taza moscow mule

| art. | Ø cm. | h. cm. | ml. | € |
|----------|-------|--------|-----|-------|
| 41463M05 | 8,5 | 10 | 550 | 15,18 |

Water transfer printing. Gold plated handle.
Stampa a trasferimento ad acqua. Manico dorato.





SS

Moscow mule mug
Tazza moscow mule
Becher Moscow Mule
Gobelet moscow mule
Taza moscow mule

| art. | Ø cm. | h. cm. | lt. | col. | € |
|----------|-------|--------|-----|------|-------|
| 41463C30 | 15,5 | 17,5 | 3 | ● | 41,41 |
| 41463C50 | 18,0 | 20,0 | 5 | ● | 52,36 |

Gold plated handle. – Manico dorato.



SS

Moscow mule mug, antique
Tazza moscow mule, antique
Becher Moscow Mule, Antik
Gobelet moscow mule, antique
Taza moscow mule, antiguo

| art. | Ø cm. | h. cm. | lt. | col. | € |
|----------|-------|--------|-----|------|-------|
| 41463A30 | 15,5 | 17,5 | 3 | ● | 43,62 |
| 41463A50 | 18,0 | 20,0 | 5 | ● | 54,47 |

Gold plated handle. – Manico dorato.



SS

Mini moscow mule mug
Mini moscow mule
Moscow Mule Shotbecher
Moscow mule à shot
Chupito moscow mule

| art. | Ø cm. | h. cm. | ml. | col. | € |
|----------|-------|--------|-----|------|-------|
| 41463C00 | 4,6 | 4,7 | 60 | ● | 23,42 |

Gold plated handle. Set 4 pcs. – Manico dorato. Conf. 4 pz.



SS

Mini moscow mule mug, antique
Mini moscow mule, antique
Moscow Mule Shotbecher, Antik
Moscow mule à shot, antique
Chupito moscow mule, antiguo

| art. | Ø cm. | h. cm. | ml. | col. | € |
|----------|-------|--------|-----|------|-------|
| 41463A00 | 4,6 | 4,7 | 60 | ● | 25,13 |

Gold plated handle. Set 4 pcs. – Manico dorato. Conf. 4 pz.



SS

Cola cup

Tazza Cola
Cola-Becher
Gobelet Cola
Taza Cola

| art. | Ø cm. | h. cm. | ml. | col. | € |
|----------|-------|--------|-----|------|-------|
| 44941G05 | 7,5 | 11 | 490 | ● | 12,06 |
| 44941C05 | 7,5 | 11 | 490 | ● | 12,06 |
| 44941B05 | 7,5 | 11 | 490 | ● | 12,06 |



SS

Mint julep cup

Coppa mint julep
Becher für Mint Julep
Tasse à cocktail mint julep
Vaso para mint julep

| art. | Ø cm. | h. cm. | ml. | col. | € |
|----------|-------|--------|-----|------|-------|
| 41497-05 | 8,5 | 10,5 | 380 | ● | 13,47 |
| 41497G05 | 8,5 | 10,5 | 380 | ● | 16,18 |
| 41497C05 | 8,5 | 10,5 | 380 | ● | 16,18 |
| 41497B05 | 8,5 | 10,5 | 380 | ● | 16,18 |



SS

Julep mug

Tazza julep
Becher Julep
Gobelet julep
Taza julep

| art. | Ø cm. | h. cm. | ml. | col. | € |
|----------|-------|--------|-----|------|-------|
| 41470C03 | 8 | 12 | 335 | ● | 11,26 |



SS

Julep mug, antique

Tazza julep, antique
Becher Julep, Antik
Gobelet julep, antique
Taza julep, antiguo

| art. | Ø cm. | h. cm. | ml. | col. | € |
|----------|-------|--------|-----|------|-------|
| 41470A03 | 8 | 12 | 335 | ● | 11,66 |



SS

Mini mug

Mini tazza
Shotbecher
Verre à shot
Vaso de chupito

| art. | Ø cm. | h. cm. | ml. | col. | € |
|----------|-------|--------|-----|------|-------|
| 41470C00 | 4,5 | 5,5 | 60 | ● | 25,43 |

Set 4 pcs. – Conf. 4 pz.



SS

Mini mug, antique

Mini tazza, antique
Shotbecher, Antik
Verre à shot, antique
Vaso de chupito, antiguo

| art. | Ø cm. | h. cm. | ml. | col. | € |
|----------|-------|--------|-----|------|-------|
| 41470A00 | 4,5 | 5,5 | 60 | ● | 27,24 |

Set 4 pcs. – Conf. 4 pz.





Tiki skull glass

Tiki mug teschio in vetro
Tiki-Schädelglas
Tiki mug crâne en verre
Vaso Tiki de vidro

| art. | Ø cm. | h. cm. | ml. | € |
|----------|-------|--------|-----|-------|
| 44948-07 | 13 | 10,5 | 700 | 10,55 |



Tiki mug ceramic

Tiki mug in ceramica
Tiki-Becher aus Keramik
Tiki mug en céramique
Taza Tiki en cerámica

| art. | h. cm. | ml. | € |
|----------|--------|-----|-------|
| 44949-02 | 22 | 500 | 11,86 |



Tiki mug ceramic

Tiki mug in ceramica
Tiki-Becher aus Keramik
Tiki mug en céramique
Taza Tiki en cerámica

| art. | Ø cm. | h. cm. | ml. | € |
|----------|-------|--------|-----|------|
| 44949-01 | 9,3 | 11 | 450 | 9,55 |



Tiki mug ceramic

Tiki mug in ceramica
Tiki-Becher aus Keramik
Tiki mug en céramique
Taza Tiki en cerámica

| art. | Ø cm. | h. cm. | ml. | € |
|----------|-------|--------|-----|-------|
| 44949-03 | 7 | 21,5 | 650 | 13,07 |



Tiki mug ceramic

Tiki mug in ceramica
Tiki-Becher aus Keramik
Tiki mug en céramique
Taza Tiki en cerámica

| art. | h. cm. | ml. | € |
|----------|--------|-----|-------|
| 44949-04 | 15 | 550 | 15,58 |



Tiki mug ceramic

Tiki mug in ceramica
Tiki-Becher aus Keramik
Tiki mug en céramique
Taza Tiki en cerámica

| art. | Ø cm. | h. cm. | ml. | € |
|----------|-------|--------|-----|-------|
| 44949-05 | 8 | 16,5 | 340 | 12,36 |



Tiki mug ceramic

Tiki mug in ceramica
Tiki-Becher aus Keramik
Tiki mug en céramique
Taza Tiki en cerámica

| art. | Ø cm. | h. cm. | ml. | € |
|----------|-------|--------|-----|-------|
| 44949-06 | 8 | 17 | 510 | 15,58 |



Tiki mug ceramic

Tiki mug in ceramica
Tiki-Becher aus Keramik
Tiki mug en céramique
Taza Tiki en cerámica

| art. | Ø cm. | h. cm. | ml. | € |
|----------|-------|--------|-----|-------|
| 44949-07 | 6,2 | 10 | 700 | 12,76 |



Tiki mug ceramic

Tiki mug in ceramica
Tiki-Becher aus Keramik
Tiki mug en céramique
Taza Tiki en cerámica

| art. | Ø cm. | h. cm. | ml. | € |
|----------|-------|--------|-----|-------|
| 44949-08 | 10 | 13 | 600 | 13,27 |



Tiki mug ceramic

Tiki mug in ceramica
Tiki-Becher aus Keramik
Tiki mug en céramique
Taza Tiki en cerámica

| art. | Ø cm. | h. cm. | ml. | € |
|----------|-------|--------|-----|-------|
| 44949-09 | 8,8 | 12,5 | 560 | 12,96 |



Tiki mug ceramic

Tiki mug in ceramica
Tiki-Becher aus Keramik
Tiki mug en céramique
Taza Tiki en cerámica

| art. | Ø cm. | h. cm. | ml. | € |
|----------|-------|--------|-----|-------|
| 44949-10 | 7 | 17,3 | 430 | 13,27 |



PVD
SS

Straight straws

Cannucce
Strohhalme
Pailles
Pajitas

| art. | Ø mm. | l. cm. | col. | € |
|----------|-------|--------|------|-------|
| 41490-00 | 6 | 21,5 | ● | 13,47 |
| 41490B00 | 6 | 21,5 | ● | 25,43 |
| 41490G00 | 6 | 21,5 | ● | 22,71 |
| 41490C00 | 6 | 21,5 | ● | 22,71 |

Set 12 pcs plus 1 straw brush.
Conf. 12 pz + 1 scovolino.



PVD
SS

Curved straws

Cannucce curve
Gebogene Strohhalme
Pailles incurvées
Pajitas curvados

| art. | Ø mm. | l. cm. | col. | € |
|----------|-------|--------|------|-------|
| 41490-01 | 6 | 21,5 | ● | 14,37 |
| 41490B01 | 6 | 21,5 | ● | 26,43 |
| 41490G01 | 6 | 21,5 | ● | 23,52 |
| 41490C01 | 6 | 21,5 | ● | 23,52 |

Set 12 pcs plus 1 straw brush.
Conf. 12 pz + 1 scovolino.



SS

Straw brush, 5 pcs

Scovolini, 5 pezzi
Strohhalme-Bürste, 5 Stk.
Brosses à pailles, 5 pièces
Cepillos para pajitas, 5 pz

| art. | l. cm. | € |
|----------|--------|------|
| 41490-AA | 21 | 3,82 |



B

Straight straws, 24 pcs

Cannucce, 24 pz
Strohhalme, 24 Stk
Pailles, 24 pièces
Pajitas, 24 piezas

| art. | Ø mm. | l. | € |
|----------|-------|-----|------|
| 48310-14 | 5-7 | 140 | 2,71 |
| 48310-20 | 5-7 | 200 | 3,22 |



B

Straight straws, 150 pcs

Cannucce, 150 pz
Strohhalme, 150 Stk
Pailles, 150 pièces
Pajitas, 150 piezas

| art. | Ø mm. | l. | € |
|----------|-------|-----|-------|
| 48311-20 | 6-8 | 200 | 19,70 |
| 48311-25 | 6-8 | 250 | 23,12 |



B

Straight straws, 110 pcs

Cannucce, 110 pz
Strohhalme, 110 Stk
Pailles, 110 pièces
Pajitas, 110 piezas

| art. | Ø mm. | l. | € |
|----------|-------|-----|-------|
| 48312-25 | 9-10 | 250 | 20,40 |



B

Straight straws, 24 pcs

Cannucce, 24 pz
Strohhalme, 24 Stk
Pailles, 24 pièces
Pajitas, 24 piezas

| art. | Ø mm. | l. | € |
|----------|-------|-----|---|
| 48313-14 | 10-12 | 140 | - |
| 48313-18 | 10-12 | 180 | - |



3 Straight straws, 3 bent, glass

3 Cannucce diritte, 3 curve in vetro
3 Gerade Strohhalme, 3 gebogene aus Glas
3 Pailles droites, 3 incurvées en verre
3 Pajitas eectas, 3 curvados de vidrio

| art. | Ø mm. | l. | € |
|----------|-------|-----|------|
| 41495-08 | 8 | 215 | 6,93 |
| 41495-10 | 10 | 215 | 7,44 |

Incl. 2 straw brushes. – Incl. 2 scovolini.



SS

Drinks stirrers flamingo, 4 pcs

Miscelatori cocktail fenicottero, 4 pz
Flamingo-Cocktail Rührer, 4 Stk
Agitateurs cocktails flamant, 4 pcs
Agitadores cócteles flamingo, 4 pz

| art. | l. cm. | col. | € |
|----------|--------|------|-------|
| 41491G00 | 21,5 | ● | 17,49 |
| 41491C00 | 21,5 | ● | 17,49 |



SS

Drinks stirrers skull, 4 pcs

Miscelatori cocktail teschio, 4 pz
Totenkopf-Cocktail Rührer, 4 Stk
Agitateurs tête de mort, 4 pcs
Agitadores cócteles cráneo, 4 pz

| art. | l. cm. | col. | € |
|----------|--------|------|-------|
| 41491G01 | 18,5 | ● | 17,49 |
| 41491C01 | 18,5 | ● | 17,49 |



SS

Drinks stirrers pineapple, 4 pcs

Miscelatori cocktail ananas, 4 pz
Ananas-Cocktail Rührer, 4 Stk
Agitateurs cocktails ananas, 4 pcs
Agitadores cócteles piña, 4 pz

| art. | l. cm. | col. | € |
|----------|--------|------|-------|
| 41491G02 | 20 | ● | 17,49 |
| 41491C02 | 20 | ● | 17,49 |



SS

Drinks stirrers owl, 4 pcs

Miscelatori cocktail gufo, 4 pz
Eule-Cocktail Rührer, 4 Stk
Agitateurs cocktails hibou, 4 pcs
Agitadores cócteles búho, 4 pz

| art. | l. cm. | col. | € |
|----------|--------|------|-------|
| 41491G03 | 20 | ● | 17,49 |
| 41491C03 | 20 | ● | 17,49 |



SS

Drinks stirrers seahorse, 4 pcs

Miscelatori cavalluccio marino, 4 pz
Seepferdchen-Cocktail Rührer, 4 Stk
Agitateurs hippocampe, 4 pcs
Agitadores caballo de mar, 4 pz

| art. | l. cm. | col. | € |
|----------|--------|------|-------|
| 41491G04 | 20,5 | ● | 17,49 |
| 41491C04 | 20,5 | ● | 17,49 |



SS

Drinks stirrers bow-knot, 4 pcs

Miscelatori cocktail fiocco, 4 pz
Bogenknoten-Cocktail Rührer, 4 Stk
Agitateurs noeud d'arc, 4 pcs
Agitadores nudo de proa, 4 pz

| art. | l. cm. | col. | € |
|----------|--------|------|-------|
| 41491G05 | 21 | ● | 17,49 |
| 41491C05 | 21 | ● | 17,49 |



SS

Drinks stirrers octopus, 4 pcs

Miscelatori cocktail polipo, 4 pz
Tintenfisch-Cocktail Rührer, 4 Stk
Agitateurs cocktails poulpe, 4 pcs
Agitadores cócteles pulpo, 4 pz

| art. | l. cm. | col. | € |
|----------|--------|------|-------|
| 41491G06 | 18,5 | ● | 17,49 |
| 41491C06 | 18,5 | ● | 17,49 |



SS

Tweezer

Pinza
Zange
Pince
Pinza

| art. | l. cm. | col. | € |
|----------|--------|------|------|
| 42902-30 | 30 | ● | 7,94 |
| 42902G30 | 30 | ● | 7,94 |



SS

Tweezer

Pinza
Zange
Pince
Pinza

| art. | l. cm. | col. | € |
|----------|--------|------|------|
| 42902C30 | 30 | ● | 7,94 |
| 42902B30 | 30 | ● | 7,94 |



SS

Tweezer

Pinza
Zange
Pince
Pinza

| art. | l. cm. | € |
|----------|--------|------|
| 42902-31 | 30 | 8,64 |



SS

Cocktail spoon

Cucchiaio miscelatore
Cocktail-Löffel
Cuillère à cocktail
Cuchara cóctel

| art. | l. cm. | € |
|----------|--------|------|
| 41605-00 | 27 | 6,93 |



SS

Cocktail spoon

Cucchiaio miscelatore
Cocktail-Löffel
Cuillère à cocktail
Cuchara cóctel

| art. | l. cm. | col. | € |
|----------|--------|------|------|
| 41605-01 | 27 | ● | 7,44 |



SS

Cocktail spoon

Cucchiaio miscelatore
Cocktail-Löffel
Cuillère à cocktail
Cuchara cóctel

| art. | l. cm. | col. | € |
|----------|--------|------|------|
| 41605G27 | 27 | ● | 7,44 |
| 41605B27 | 27 | ● | 7,44 |



SS

Cocktail spoon, antique

Cucchiaio miscelatore, antique
Cocktail-Löffel, Antique
Cuillère à cocktail, antique
Cuchara cóctel, antique

| art. | l. cm. | € |
|----------|--------|------|
| 41605A27 | 27 | 7,44 |



SS

Cocktail spoon/fork, antique

Cucchiaio/forchetta miscelatore, antique
Cocktail-Löffell/-Gabel, Antique
Cuillère/fourchette à cocktail, antique
Cuchara/tenedor cóctel, antique

| art. | l. cm. | € |
|----------|--------|------|
| 41605A30 | 30 | 7,54 |
| 41605A03 | 50 | 8,74 |



SS

Cocktail spoon/fork

Cucchiaio/forchetta miscelatore
Cocktail-Löffell/-Gabel
Cuillère/fourchette à cocktail
Cuchara/tenedor cóctel

| art. | l. cm. | col. | € |
|----------|--------|------|------|
| 41605-30 | 30 | ● | 6,53 |
| 41605G30 | 30 | ● | 7,54 |



SS

Cocktail spoon/fork

Cucchiaio/forchetta miscelatore
Cocktail-Löffell/-Gabel
Cuillère/fourchette à cocktail
Cuchara/tenedor cóctel

| art. | l. cm. | col. | € |
|----------|--------|------|------|
| 41605C30 | 30 | ● | 7,54 |
| 41605B30 | 30 | ● | 7,54 |



SS

Cocktail spoon/fork

Cucchiaio/forchetta miscelatore
Cocktail-Löffell/-Gabel
Cuillère/fourchette à cocktail
Cuchara/tenedor cóctel

| art. | l. cm. | col. | € |
|----------|--------|------|------|
| 41605-03 | 50 | ● | 7,74 |
| 41605G03 | 50 | ● | 8,74 |





SS

Cocktail spoon/fork

Cucchiaio/forchetta miscelatore
Cocktail-Löffell/-Gabel
Cuillère/fourchette à cocktail
Cuchara/tenedor cóctel

| art. | l. cm. | col. | € |
|----------|--------|------|------|
| 41605C03 | 50 | ● | 8,74 |
| 41605B03 | 50 | ● | 8,74 |



SS

Absinthe spoon

Cucchiaio assenzio
Absinth-Löffel
Cuillère d'absinthe
Cuchara de ajenjo

| art. | l. cm. | col. | € |
|----------|--------|------|------|
| 41600-00 | 16 | ● | 5,83 |
| 41600G00 | 16 | ● | 8,24 |
| 41600C00 | 16 | ● | 8,24 |



SS

Magic spoon whisks

Cucchiaio magico
Zauberlöffel
Fouet plat à spirales
Cuchara mágica

| art. | l. cm. | € |
|----------|--------|------|
| 41595-20 | 20 | 5,03 |



SS

Strainer, antique

Colino, antique
Sieb, Antique
Passoire, antique
Colador, antique

| art. | Ø cm. | € |
|----------|-------|------|
| 41570A10 | 8 | 8,24 |



SS

Strainer

Colino
Sieb
Passoire
Colador

| art. | Ø cm. | col. | € |
|----------|-------|------|------|
| 41570-10 | 8 | ● | 6,03 |
| 41570G10 | 8 | ● | 8,24 |



SS

Strainer

Colino
Sieb
Passoire
Colador

| art. | Ø cm. | col. | € |
|----------|-------|------|------|
| 41570C10 | 8 | ● | 8,24 |
| 41570B10 | 8 | ● | 8,24 |



SS

Cocktail strainer, antique

Colino cocktail, antique
Cocktail-Sieb, Antique
Passoire à cocktail, antique
Colador de cóctel, antique

| art. | Ø cm. | € |
|----------|-------|-------|
| 41603A00 | 9 | 12,36 |



SS

Cocktail strainer

Colino cocktail
Cocktail-Sieb
Passoire à cocktail
Colador de cóctel

| art. | Ø cm. | col. | € |
|----------|-------|------|-------|
| 41603-00 | 9 | ● | 8,14 |
| 41603G00 | 9 | ● | 12,36 |



SS

Cocktail strainer

Colino cocktail
Cocktail-Sieb
Passoire à cocktail
Colador de cóctel

| art. | Ø cm. | col. | € |
|----------|-------|------|-------|
| 41603C00 | 9 | ● | 12,36 |
| 41603B00 | 9 | ● | 12,36 |



SS

Julep strainer, antique

Colino Julep, antique
Julep Barsieb, Antique
Tamis cocktail Julep, antique
Colador de cóctel

| art. | Ø cm. | € |
|----------|-------|-------|
| 41603A07 | 7 | 10,85 |



SS

Julep strainer

Colino Julep
Julep Barsieb
Tamis cocktail Julep
Colador de cóctel

| art. | Ø cm. | col. | € |
|----------|-------|------|-------|
| 41603-07 | 7 | ● | 7,54 |
| 41603G07 | 7 | ● | 10,85 |



SS

Julep strainer

Colino Julep
Julep Barsieb
Tamis cocktail Julep
Colador de cóctel

| art. | Ø cm. | col. | € |
|----------|-------|------|-------|
| 41603C07 | 7 | ● | 10,85 |
| 41603B07 | 7 | ● | 10,85 |



SS

Cocktail measuring cup

Misurino cocktail
Alkohol-Meßbecher
Mesureur de cocktail
Medidor de cóctel

| art. | ml. | € |
|----------|-----|------|
| 41609-75 | 75 | 6,53 |



SS

Cocktail jigger, antique

Misurino cocktail, antique
Cocktail-Doppelmaß, Antique
Mesureur de cocktail, antique
Medidor de cóctel, antique

| art. | ml. | € |
|----------|-------|-------|
| 41609A36 | 30/60 | 15,68 |



SS

Cocktail jigger, antique

Misurino cocktail, antique
Cocktail-Doppelmaß, Antique
Mesureur de cocktail, antique
Medidor de cóctel, antique

| art. | ml. | € |
|----------|-------|------|
| 41604A00 | 20/40 | 6,93 |



SS

Japanese jigger, antique

Misurino cocktail Giappone, antique
Japanischer Messbecher, Antique
Mesureur de cocktail Japonais, antique
Medidor de cóctel Japonés, antique

| art. | ml. | € |
|----------|-------|-------|
| 41604A01 | 20/40 | 10,55 |



SS

Cocktail jigger

Misurino cocktail
Cocktail-Doppelmaß
Mesureur de cocktail
Medidor de cóctel

| art. | ml. | col. | € |
|----------|-------|------|-------|
| 41609-36 | 30/60 | ● | 12,26 |
| 41609G36 | 30/60 | ● | 15,68 |
| 41609C36 | 30/60 | ● | 15,68 |
| 41609B36 | 30/60 | ● | 15,68 |



SS

Cocktail jigger

Misurino cocktail
Cocktail-Doppelmaß
Mesureur de cocktail
Medidor de cóctel

| art. | ml. | col. | € |
|----------|-------|------|------|
| 41604-00 | 20/40 | ● | 5,73 |
| 41604G00 | 20/40 | ● | 6,93 |
| 41604C00 | 20/40 | ● | 6,93 |
| 41604B00 | 20/40 | ● | 6,93 |





SS

Japanese jigger

Misurino cocktail Giapponese
Japanischer Messbecher
Mesureur de cocktail Japonais
Medidor de cóctel Japonés

| art. | ml. | col. | € |
|----------|-------|------|-------|
| 41604-01 | 20/40 | ● | 7,94 |
| 41604G01 | 20/40 | ● | 10,55 |
| 41604C01 | 20/40 | ● | 10,55 |
| 41604B01 | 20/40 | ● | 10,55 |



SS

Long-drink shaker, antique

Shaker, antique
Shaker, Antique
Shaker, antique
Coctelera, antique

| art. | Ø cm. | h. cm. | ml. | € |
|----------|-------|--------|-----|-------|
| 41484A05 | 8,8 | 20,5 | 500 | 20,80 |



SS

Long-drink shaker, antique

Shaker, antique
Shaker, Antique
Shaker, antique
Coctelera, antique

| art. | ml. | € |
|----------|-----|-------|
| 41480A05 | 500 | 20,10 |



SS

Shaker parisienne, antique

Shaker parisienne, antique
Shaker parisienne, Antique
Shaker parisienne, antique
Coctelera parisienne, antique

| art. | Ø cm. | h. cm. | ml. | € |
|----------|-------|--------|-----|-------|
| 41461A07 | 9 | 23 | 700 | 23,52 |



SS

Shaker calabrese, antique

Shaker calabrese, antique
Shaker calabrese, Antique
Shaker calabrese, antique
Coctelera calabrese, antique

| art. | Ø cm. | h. cm. | ml. | € |
|----------|-------|--------|-----|-------|
| 41464A09 | 9,5 | 24,5 | 900 | 24,92 |



SS

Boston tin + half tin, antique

Shaker boston 2 pz, antique
Boston Shaker, 2 Stk, Antique
Shaker boston, 2 pcs, antique
Coctelera boston, 2 pz, antique

| art. | Ø cm. | ml. | € |
|----------|-------|---------|-------|
| 41467A08 | 9 | 790/590 | 28,54 |



SS

Long-drink shaker

Shaker
Shaker
Shaker
Coctelera

| art. | Ø cm. | h. cm. | ml. | col. | € |
|----------|-------|--------|-----|------|-------|
| 41484-05 | 8,8 | 20,5 | 500 | ● | 14,67 |
| 41484G05 | 8,8 | 20,5 | 500 | ● | 20,80 |
| 41484C05 | 8,8 | 20,5 | 500 | ● | 20,80 |
| 41484B05 | 8,8 | 20,5 | 500 | ● | 20,80 |



SS

Long-drink shaker

Shaker
Shaker
Shaker
Coctelera

| art. | Ø cm. | h. cm. | ml. | col. | € |
|----------|-------|--------|-----|------|-------|
| 41480G05 | 8,7 | 20,5 | 500 | ● | 20,10 |
| 41480C05 | 8,7 | 20,5 | 500 | ● | 20,10 |
| 41480B05 | 8,7 | 20,5 | 500 | ● | 20,10 |



SS

Shaker parisienne

Shaker parisienne
Shaker parisienne
Shaker parisienne
Coctelera parisienne

| art. | Ø cm. | h. cm. | ml. | col. | € |
|----------|-------|--------|-----|------|-------|
| 41461-07 | 9 | 23 | 700 | ● | 17,29 |
| 41461G07 | 9 | 23 | 700 | ● | 23,52 |
| 41461C07 | 9 | 23 | 700 | ● | 23,52 |
| 41461B07 | 9 | 23 | 700 | ● | 23,52 |



SS

Shaker calabrese

Shaker calabrese
Shaker Calabrese
Shaker calabrese
Coctelera calabrese

| art. | Ø cm. | h. cm. | ml. | col. | € |
|----------|-------|--------|-----|------|-------|
| 41464-09 | 9,5 | 24,5 | 900 | ● | 18,69 |
| 41464G09 | 9,5 | 24,5 | 900 | ● | 24,92 |
| 41464C09 | 9,5 | 24,5 | 900 | ● | 24,92 |
| 41464B09 | 9,5 | 24,5 | 900 | ● | 24,92 |



SS

Boston tin + half tin

Shaker boston 2 pz
Boston Shaker, 2 Stk
Shaker boston, 2 pcs
Coctelera boston, 2 pz

| art. | Ø cm. | ml. | col. | € |
|----------|-------|---------|------|-------|
| 41467G08 | 9 | 790/590 | ● | 28,54 |
| 41467C08 | 9 | 790/590 | ● | 28,54 |
| 41467B08 | 9 | 790/590 | ● | 28,54 |



SS

Long-drink shaker

Shaker
Shaker
Shaker
Coctelera

| art. | ml. | € |
|----------|-----|-------|
| 41480-03 | 200 | 14,27 |
| 41480-05 | 500 | 15,58 |
| 41480-07 | 700 | 26,03 |



SS

SAN

Long-drink shaker

Shaker
Shaker
Shaker
Coctelera

| art. | ml. | col. | € |
|----------|-----|------|-------|
| 41481-02 | 550 | ● | 24,12 |
| 41481-03 | 550 | ● | 24,12 |



PS

Long-drink shaker

Shaker
Shaker
Shaker
Coctelera

| art. | h. cm. | ml. | € |
|----------|--------|-----|------|
| 41483-04 | 22,5 | 450 | 6,53 |



SS

Boston shaker, vinyl coated

Cono boston, rivestimento vinile
Boston-Shaker, Vinyl Überzug
Shaker boston, revêtement en vinyle
Coctelera boston, revestimiento vinilo

| art. | Ø cm. | h. cm. | ml. | col. | € |
|----------|-------|--------|-----|------|-------|
| 41479-11 | 9 | 18 | 830 | ● | 19,30 |



SS

Boston shaker

Cono boston con fondello
Boston-Shaker
Shaker boston
Coctelera boston

| art. | Ø cm. | h. cm. | ml. | € |
|----------|-------|--------|-----|-------|
| 41479-05 | 9 | 17 | 500 | 17,49 |



Mixing glass

Bicchiere miscelatore
Rührglas
Verre mélangeur
Vaso mezclador

| art. | Ø cm. | h. cm. | ml. | € |
|----------|-------|--------|-----|------|
| 41479-AA | 8,5 | 15 | 500 | 4,32 |



Mixing glass

Bicchiere miscelatore
Rührglas
Verre mélangeur
Vaso mezclador

| art. | Ø cm. | h. cm. | ml. | € |
|----------|-------|--------|-----|------|
| 41478-50 | 8,8 | 15 | 473 | 7,44 |
| 41478-35 | 8,3 | 13 | 355 | 4,52 |



Mixing glass

Bicchiere miscelatore
Rührglas
Verre mélangeur
Vaso mezclador

| art. | Ø cm. | h. cm. | ml. | € |
|----------|-------|--------|-----|------|
| 41477-50 | 9 | 15 | 473 | 8,14 |

With ounce markings. – Graduato in once.



Mixing glass with lip

Bicchiere miscelatore con becco versatore
Rührglas mit Lippe
Verre mélangeur avec bec verseur
Vaso mezclador vertedor con pico

| art. | Ø cm. | h. cm. | lt. | € |
|----------|-------|--------|-----|-------|
| 41514-05 | 9 | 16,5 | 0,5 | 24,42 |



Mixing glass with lip

Bicchiere miscelatore con becco versatore
Rührglas mit Lippe
Verre mélangeur avec bec verseur
Vaso mezclador vertedor con pico

| art. | Ø cm. | h. cm. | lt. | € |
|----------|-------|--------|------|-------|
| 41514-10 | 11,5 | 19 | 0,95 | 29,04 |



PC

Whiskey glass

Bicchiere whiskey
Whiskey Glas
Verre à whiskey
Vaso whiskey

| art. | Ø cm. | h. cm. | ml. | € |
|----------|-------|--------|-----|------|
| 44940-01 | 8,5 | 9,5 | 420 | 6,03 |

U.Pack 6 pcs



PC

Juice glass

Bicchiere succo
Fruchtsaft-Glas
Verre à jus
Vaso zumo

| art. | Ø cm. | h. cm. | ml. | € |
|----------|-------|--------|-----|------|
| 44940-02 | 7,5 | 15,5 | 460 | 6,53 |

U.Pack 6 pcs



PC

Beer glass

Boccale birra
Bier-Glas
Verre à bière
Vaso cerveza

| art. | Ø cm. | h. cm. | ml. | € |
|----------|-------|--------|-----|------|
| 44940-06 | 8 | 23 | 450 | 6,23 |

U.Pack 6 pcs



SMMA

Beer glass
Boccale birra
Bier-Glas
Verre à bière
Vaso cerveza

| art. | Ø cm. | h. cm. | ml. | € |
|----------|-------|--------|-----|------|
| 44940-08 | 9 | 16 | 500 | 9,55 |

U.Pack 6 pcs



PC

Margarita glass
Bicchiere margarita
Margarita-Glas
Verre à margarita
Vaso margarita

| art. | Ø cm. | h. cm. | ml. | € |
|----------|-------|--------|-----|------|
| 44940-10 | 12 | 18 | 300 | 5,43 |

U.Pack 6 pcs



PC

Martini glass
Bicchiere martini
Martini-Glas
Verre à martini
Vaso martini

| art. | Ø cm. | h. cm. | ml. | € |
|----------|-------|--------|-----|------|
| 44940-11 | 12 | 17 | 240 | 5,13 |

U.Pack 6 pcs



PC

Wine glass
Bicchiere vino
Wein-Glas
Verre à vin
Vaso vino

| art. | Ø cm. | h. cm. | ml. | € |
|----------|-------|--------|-----|------|
| 44940-12 | 7 | 21 | 300 | 6,13 |

U.Pack 6 pcs



PC

Wine glass
Bicchiere vino
Wein-Glas
Verre à vin
Vaso vino

| art. | Ø cm. | h. cm. | ml. | € |
|----------|-------|--------|-----|------|
| 44940-13 | 7 | 19 | 200 | 6,03 |

U.Pack 6 pcs



PC

Champagne glass
Bicchiere spumante
Sekt-Glas
Flûte
Vaso champaña

| art. | Ø cm. | h. cm. | ml. | € |
|----------|-------|--------|-----|------|
| 44940-14 | 5 | 22 | 180 | 4,92 |

U.Pack 6 pcs



PC

Mixing glass
Bicchiere
Glas
Verre
Vaso

| art. | Ø cm. | h. cm. | ml. | € |
|----------|-------|--------|-----|------|
| 44940-16 | 9 | 16 | 540 | 7,14 |

U.Pack 6 pcs



PC

Whiskey/rocks glass
Bicchiere whiskey/rocks
Whiskey-/Rocks-Glas
Verre à whiskey/rocks
Vaso whiskey/rocks

| art. | Ø cm. | h. cm. | ml. | € |
|----------|-------|--------|-----|------|
| 44940-17 | 9 | 12 | 420 | 6,73 |

U.Pack 6 pcs



PC

Whiskey/rocks glass
Bicchiere whiskey/rocks
Whiskey-/Rocks-Glas
Verre à whiskey/rocks
Vaso whiskey/rocks

| art. | Ø cm. | h. cm. | ml. | € |
|----------|-------|--------|-----|------|
| 44940-18 | 8,5 | 11,5 | 420 | 4,82 |

U.Pack 6 pcs



PC

Cooler
Bicchiere
Glas
Verre
Vaso

| art. | Ø cm. | h. cm. | ml. | € |
|----------|-------|--------|-----|------|
| 44940-19 | 8 | 17 | 540 | 6,13 |

U.Pack 6 pcs



PC

Tumbler
Bicchiere
Trinkbecher
Gobelet
Vaso

| art. | Ø cm. | h. cm. | ml. | € |
|----------|-------|--------|-----|------|
| 44940-24 | 7,5 | 12,5 | 360 | 2,91 |
| 44940-25 | 8,0 | 13,5 | 480 | 4,22 |
| 44940-26 | 8,5 | 16,0 | 660 | 4,92 |

U.Pack 6 pcs



PC

Tumbler
Bicchiere
Trinkbecher
Gobelet
Vaso

| art. | Ø cm. | h. cm. | ml. | € |
|----------|-------|--------|-----|------|
| 44940-32 | 7,5 | 12,5 | 360 | 2,71 |
| 44940-33 | 8,0 | 13,5 | 480 | 3,62 |
| 44940-34 | 8,5 | 16,0 | 660 | 3,62 |

U.Pack 6 pcs





SAN

Tumbler
Bicchieri
Trinkbecher
Gobelet
Vaso

| art. | Ø cm. | h. cm. | ml. | € |
|----------|-------|--------|-----|------|
| 44990-15 | 5,5 | 9,5 | 150 | 1,11 |
| 44990-24 | 6,5 | 10,0 | 240 | 1,51 |
| 44990-29 | 7,0 | 11,0 | 290 | 1,71 |
| 44990-36 | 7,5 | 13,0 | 360 | 2,01 |
| 44990-48 | 8,0 | 15,0 | 480 | 2,41 |

U.Pack 6 pcs



Cover with spout
Coperchio con beccuccio
Deckel mit Ausguss
Couvreclcle avec bec
Tapa con boquilla

| art. | Ø cm. | U. Pack | € |
|----------|-------|---------|------|
| 44871-23 | 7 | 10 | 4,12 |

TPE. For PC glasses 250 ml.
TPE. Per bicchieri in PC da 250 ml.



PC

Water tumbler
Bicchieri acqua
Wasserglas
Verre à eau
Vaso agua

| art. | Ø cm. | h. cm. | ml. | U. Pack | € |
|----------|-------|--------|-----|---------|------|
| 44871-20 | 7,0 | 7,0 | 170 | 50 | 2,71 |
| 44871-21 | 7,0 | 10,2 | 250 | 50 | 2,81 |
| 44871-22 | 7,8 | 11,4 | 350 | 30 | 3,12 |



PC

Water tumbler
Bicchieri acqua
Wasserglas
Verre à eau
Vaso agua

| art. | Ø cm. | h. cm. | ml. | U. Pack | col. | € |
|----------|-------|--------|-----|---------|------|------|
| 44871R20 | 7,0 | 7,0 | 170 | 50 | ● | 2,81 |
| 44871L20 | 7,0 | 7,0 | 170 | 50 | ● | 2,81 |
| 44871G20 | 7,0 | 7,0 | 170 | 50 | ● | 2,81 |
| 44871B20 | 7,0 | 7,0 | 170 | 50 | ● | 2,81 |



PC

Water tumbler
Bicchieri acqua
Wasserglas
Verre à eau
Vaso agua

| art. | Ø cm. | h. cm. | ml. | U. Pack | col. | € |
|----------|-------|--------|-----|---------|------|------|
| 44871R21 | 7,0 | 10,2 | 250 | 50 | ● | 2,91 |
| 44871L21 | 7,0 | 10,2 | 250 | 50 | ● | 2,91 |
| 44871G21 | 7,0 | 10,2 | 250 | 50 | ● | 2,91 |
| 44871B21 | 7,0 | 10,2 | 250 | 50 | ● | 2,91 |



PC

Water jug
Caraffa
Wasserkrug
Crûche à eau
Jarra agua

| art. | dim. cm. | l. | € |
|----------|-----------|-----|-------|
| 44871-28 | 12x13,8 | 0,5 | 9,95 |
| 44871-30 | 17,4x17 | 1,0 | 13,27 |
| 44871-32 | 18,7x19,8 | 1,5 | 16,88 |
| 44871-34 | 21,6x18,8 | 2,0 | 21,11 |

Withstands temperatures/Termoresistenti da:
-30° +120°C.



PP

Lid
Coperchio
Deckel
Couvreclcle
Tapa

| art. | dim. cm. | fits/per | U. Pack | € |
|----------|----------|----------|---------|------|
| 44871-29 | 9,9x1,4 | l. 0,5 | 10 | 2,81 |
| 44871-31 | 11,2x1,9 | l. 1,0 | 10 | 4,52 |
| 44871-33 | 14x2,4 | l. 1,5 | 10 | 4,62 |
| 44871-35 | 15,9x2,2 | l. 2,0 | 10 | 4,62 |

Withstands temperatures/Termoresistenti da:
-40° +100°C.



Cocktail glass
Bicchiere cocktail
Cocktail Glas
Verre à cocktail
Vaso cocktail

| art. | Ø cm. | h. cm. | ml. | € |
|----------|-------|--------|-----|------|
| 44942-01 | 8 | 21 | 350 | 4,92 |

U.Pack 6 pcs



Cocktail glass
Bicchiere cocktail
Cocktail Glas
Verre à cocktail
Vaso cocktail

| art. | Ø cm. | h. cm. | ml. | € |
|----------|-------|--------|-----|------|
| 44942-02 | 11 | 21 | 460 | 4,92 |

U.Pack 6 pcs



Martini glass
Bicchiere martini
Martini-Glas
Verre à martini
Vaso martini

| art. | Ø cm. | h. cm. | ml. | € |
|----------|-------|--------|-----|------|
| 44942-03 | 10,5 | 20 | 340 | 4,72 |

U.Pack 6 pcs



Cocktail glass
Bicchiere cocktail
Cocktail Glas
Verre à cocktail
Vaso cocktail

| art. | Ø cm. | h. cm. | ml. | € |
|----------|-------|--------|-----|------|
| 44942-04 | 7,5 | 23 | 220 | 4,62 |

U.Pack 6 pcs



Margarita glass
Bicchiere margarita
Margarita-Glas
Verre à margarita
Vaso margarita

| art. | Ø cm. | h. cm. | ml. | € |
|----------|-------|--------|-----|------|
| 44942-05 | 12 | 17,5 | 340 | 5,23 |

U.Pack 6 pcs



Fruit basket
Cesto agrumi
Obstkorb
Panier à fruits
Cesta frutas

| art. | Ø cm. | h. cm. | € |
|----------|-------|--------|-------|
| 41611-20 | 21,5 | 20 | 38,99 |



Fruit basket, oval
Cesto frutta, ovale
Obstschale, oval
Panier à fruits, ovale
Cesta fruta, oval

| art. | dim. cm. | € |
|----------|----------|-------|
| 42956-19 | 19x15 | 22,41 |
| 42956-24 | 24,5x18 | 27,64 |
| 42956-28 | 28x21 | 30,45 |



Fruit basket
Cesto frutta
Obstschale
Panier à fruits
Cesta fruta

| art. | Ø cm. | h. cm. | € |
|----------|-------|--------|------|
| 42882-23 | 23 | 25 | 9,45 |

Metal frame, black powder coating.
Metallo verniciato a polvere nero.

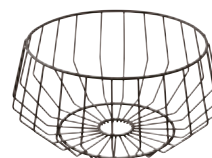

Fruit basket
Cesto frutta
Obstschale
Panier à fruits
Cesta fruta

| art. | Ø cm. | h. cm. | € |
|----------|-------|--------|------|
| 42882-28 | 28 | 14 | 9,65 |

Metal frame, black powder coating.
Metallo verniciato a polvere nero.



Serving stand 2-tier

Alzata 2 piani
Serviergestell, 2-stufig
Présentoir 2 étages
Soporte 2 niveles

| art. | dim. cm. | € |
|----------|----------|--------|
| 41208-06 | 31x17x38 | 103,41 |

Black metal frame with non-slip feet, 2 baskets 29x16x7 cm, 2 acacia wood boards 28,5x15,5x1,5 cm. – Struttura in metallo nero con piedini antiscivolo, 2 cesti cm 29x16x7, 2 assi in legno di acacia cm 28,5x15,5x1,5.



Fruit basket 2-tier

Cesto agrumi 2 piani
Obstkorb, 2-stufig
Panier à fruits 2 étages
Cesta frutas 2 niveles

| art. | Ø cm. | h. cm. | € |
|----------|-------|--------|-------|
| 41208-02 | 22/26 | 48 | 67,84 |

Wooden handle, metal black baskets Ø 22 H 6 cm and Ø 26 H 8 cm. – Manico legno, cesti in metallo nero Ø 22 H 6 cm e Ø 26 H 8 cm.



Orange juicer, chromed

Spremiagrumi manuale, cromato
Orangepresse, verchromt
Presse-agrumes, chromé
Exprimidor de cítricos, cromado

| art. | dim. cm. | € |
|----------|----------|-------|
| 41456-02 | 18x13x46 | 43,42 |



SS

Lemon squeezer

Spremilimone
Zitronenpresse
Presse citron
Exprime limones

| art. | dim. cm. | € |
|----------|----------|------|
| 41606-00 | 12,5x6,5 | 6,73 |



SS

Lemon squeezer

Spremilimone
Zitronenpresse
Presse citron
Exprime limones

| art. | dim. cm. | € |
|----------|----------|------|
| 41606-01 | 7x8,5 | 3,82 |



Lemon squeezer, aluminum

Spremilimone, alluminio
Zitronenpresse, aluminum
Presse citron, alu
Exprime limones, aluminio

| art. | l. cm. | € |
|----------|--------|------|
| 41606-02 | 20 | 7,44 |



Lemon/lime squeezer, aluminum

Spremilimone/limone, alluminio
Zitronen-/Limettenpresse, aluminum
Presse citron, alu
Exprimidor de limón/lima, aluminio

| art. | dim. cm. | € |
|----------|----------|-------|
| 41606-22 | 22x7,5 | 10,25 |

3 pieces, powder coated yellow and green.
3 pezzi, verniciato a polvere giallo e verde.



Soda siphon

Sifone soda
Soda Siphon
Siphon à eau de seltz
Sifón agua de seltz

| art. | lt. | € |
|----------|-----|--------|
| 41453-11 | 1 | 137,99 |



Soda siphon

Sifone soda
Soda Siphon
Siphon à eau de seltz
Sifón agua de seltz

| art. | lt. | € |
|----------|-----|--------|
| 41465-10 | 1 | 183,71 |



Soda siphon

Sifone soda
Soda Siphon
Siphon à eau de seltz
Sifón agua de seltz

| art. | lt. | € |
|----------|-----|--------|
| 41454-01 | 1 | 105,63 |



2 Bottles Twist&Sparkle

2 Bottiglie Twist&Sparkle
2 Flaschen Twist&Sparkle
2 Bouteilles Twist&Sparkle
2 Botellas Twist&Sparkle

| art. | lt. | € |
|----------|-----|-------|
| 41454-99 | 1 | 46,23 |



Soda chargers, 10-pcs set

Ricariche soda, 10 pezzi
10-Stk. Sodakapseln-Packung
Capsules à eau de seltz, set 10 pcs
Cápsulas para agua de seltz, 10 pz

| art. | € |
|----------|-------|
| 41453-AA | 10,85 |

Content: 8 g of CO2. – Contenuto: 8 gr di CO2.



Ice pick

Rompighiaccio
Eisstößel
Casse-glace
Pico para hielo

| art. | l. cm. | € |
|----------|--------|------|
| 44105-00 | 23 | 8,14 |

Wooden handle. – Manico legno.



Muddler, plastic

Pestaghiaccio, plastica
Eiszerstosser, Kunststoff
Pic à glace, plastique
Pico para hielo, plástico

| art. | l. cm. | € |
|----------|--------|------|
| 41503-22 | 22,5 | 5,93 |



SS

Muddler

Pestaghiaccio
Eiszerstosser
Pic à glace
Pico para hielo

| art. | l. cm. | € |
|----------|--------|------|
| 41503-21 | 20 | 8,14 |



SS

Muddler

Pestaghiaccio
Eiszerstosser
Pic à glace
Pico para hielo

| art. | l. cm. | col. | € |
|----------|--------|------|------|
| 41503G21 | 20 | ● | 9,25 |
| 41503C21 | 20 | ● | 9,25 |



Ice crusher, chromed

Tritaghiaccio, cromato
Eiswolf, verchromt
Broyer à glace, chromé
Trituradora de hielo, cromada

| art. | dim. cm. | € |
|----------|----------|-------|
| 41457-00 | 15x12x26 | 63,62 |



SS

Ice scoop

Sessola per ghiaccio
Eisschaufel
Pelle à glace
Librador para hielo

| art. | ml. | € |
|----------|-----|-------|
| 41503-00 | 100 | 22,01 |



PC

Ice scoop

Sessola per ghiaccio
Eisschaufel
Pelle à glace
Librador para hielo

| art. | ml. | € |
|----------|-----|------|
| 14958-01 | 100 | 4,42 |
| 14958-02 | 250 | 5,83 |



SS

Ice spoon

Cucchiaio ghiaccio
Eislöffel
Cuillère à glace
Cuchara hielo

| art. | l. cm. | € |
|----------|--------|------|
| 12550-04 | 22 | 9,25 |



Mold for ice-ball, silicone

Stampo sfera di ghiaccio, silicone
Eis-Kugel-Former, Silikon
Moule à boule de glace, silicone
Molde bola de hielo, silicona

| art. | dim. cm. | € |
|----------|----------|------|
| 41515-10 | 6,5x7,5 | 6,33 |

For 1 ball ø 6 cm. – Per 1 sfera ø 6 cm.



PP

Mold for ice-balls

Stampo sfere di ghiaccio
Eis-Kugel-Former
Moule pour boules de glace
Molde bolas de hielo

| art. | dim. cm. | € |
|----------|----------|------|
| 41515-03 | 24x8,5 | 9,85 |

For 3 balls ø 5,5 cm, 100 ml.
Per 3 sfere ø 5,5 cm da 100 ml.



Mold for ice-balls, silicone

Stampo sfere di ghiaccio, silicone
Eis-Kugel-Former, Silikon
Moule à boules de glace, silicone
Molde bolas de hielo, silicona

| art. | dim. cm. | € |
|----------|---------------|------|
| 41515-08 | 13,5x13,5x4,5 | 6,33 |

For 4 balls ø 4,5 cm. – Per 4 sfere ø 4,5 cm.



Mold for ice-balls, silicone

Stampo sfere di ghiaccio, silicone
Eis-Kugel-Former, Silikon
Moule à boules de glace, silicone
Molde bolas de hielo, silicona

| art. | dim. cm. | € |
|----------|-----------|-------|
| 41515-09 | 25x12,5x5 | 10,15 |

For 8 balls ø 4 cm. – Per 8 sfere ø 4 cm.

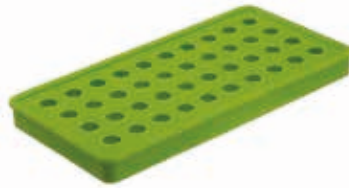

Mold for ice-balls, silicone

Stampo sfere di ghiaccio, silicone
Eis-Kugel-Former, Silikon
Moule à boules de glace, silicone
Molde bolas de hielo, silicona

| art. | dim. cm. | € |
|----------|----------|-------|
| 41515-22 | 24x12x2 | 11,36 |

For 40 balls ø 1 cm. – Per 40 sfere ø 1 cm.



Mold for ice-skulls, silicone

Stampo teschi ghiaccio, silicone
Eis-Schädel-Former, Silikon
Moule à crânes de glace, silicone
Molde de crâneos de hielo, silicona

| art. | dim. cm. | € |
|----------|--------------|------|
| 41515-05 | 11,5x7,5x4,3 | 7,64 |



Mold for ice-diamonds, silicone

Stampo diamanti ghiaccio, silicone
Eis-Diamant-Former, Silikon
Moule à diamants de glace, silicone
Molde de diamante de hielo, silicona

| art. | dim. cm. | € |
|----------|-----------|------|
| 41515-07 | 12x12x3,8 | 7,94 |



NEW

Mold for ice-roses, silicone

Stampo rose ghiaccio, silicone
Eis-Rosen-Former, Silikon
Moule à roses de glace, silicone
Molde de rosas de hielo, silicona

| art. | dim. cm. | € |
|----------|-------------|-------|
| 41515-06 | 16,8x16,8x6 | 12,56 |



NEW

Mold for ice-cubes, silicone

Stampo cubi ghiaccio, silicone
Eiswürfel-Former, Silikon
Moule à glaçons, silicone
Molde cubos de hielo, silicona

| art. | dim. cm. | € |
|----------|-------------|------|
| 41515-19 | 16,7x16,7x5 | 6,73 |

For 6 cubes 4,7 cm. – Per 6 cubi 4,7 cm.



NEW

Mold for ice-cubes, silicone

Stampo cubi ghiaccio, silicone
Eiswürfel-Former, Silikon
Moule à glaçons, silicone
Molde cubos de hielo, silicona

| art. | dim. cm. | € |
|----------|-------------|------|
| 41515-18 | 11,7x11,7x5 | 5,63 |

For 4 cubes 4,7 cm. – Per 4 cubi 4,7 cm.



Mold for ice-cubes, silicone

Stampo cubetti ghiaccio, silicone
Eiswürfel-Former, Silikon
Moule à glaçons, silicone
Molde cubitos de hielo, silicona

| art. | dim. cm. | € |
|----------|-------------|-------|
| 41515-20 | 27x13,5x3,5 | 11,36 |

For 21 cubes 3 cm. – Per 21 cubetti 3 cm.



Mold for ice-cubes, silicone

Stampo cubetti ghiaccio, silicone
Eiswürfel-Former, Silikon
Moule à glaçons, silicone
Molde cubitos de hielo, silicona

| art. | dim. cm. | € |
|----------|----------|-------|
| 41515-21 | 25x12x3 | 11,86 |

For 32 cubes 2,5 cm. – Per 32 cubetti 2,5 cm.



SS

Ice tongs

Molla ghiaccio
Eiszange
Pince à glace
Pinza hielo

| art. | l. cm. | col. | € |
|----------|--------|------|------|
| 41518G12 | 16 | ● | 7,44 |
| 41518C12 | 16 | ● | 7,44 |
| 41518B12 | 16 | ● | 7,44 |



SS

Ice tongs, antique

Molla ghiaccio, antique
Eiszange, Antique
Pince à glace, antique
Pinza hielo, antique

| art. | l. cm. | € |
|----------|--------|------|
| 41518A12 | 16 | 7,44 |



Ice bucket with tongs

Secchio ghiaccio e pinza
Eiseimer mit Eiszange
Seau à glace avec pince
Cubo hielo con pinza

| art. | Ø mm. | h. cm. | lt. | € |
|----------|-------|--------|-----|-------|
| 41513-13 | 14 | 22 | 1,3 | 48,44 |

Noble plastic jacket highly chrome plated with special insulated plastic insert. – Camicia in materiale plastico, finitura cromata lucida con speciale inserto termico.



PP

SAN

Ice box

Secchio ghiaccio
Eisbox
Seau à glace
Cubitera

| art. | dim. cm. | lt. | € |
|----------|----------|-----|-------|
| 41512-50 | 27x27x15 | 5,4 | 82,71 |

With drainer. – Con griglia.



SS

Ice bucket

Secchio ghiaccio
Eisbehälter
Seau à glace
Cubitera hielo

| art. | Ø cm. | h. cm. | € |
|-----------|-------|--------|-------|
| 46116-15● | 12,5 | 13 | 81,81 |





SS

Ice bucket

Secchio ghiaccio
Eisbehälter
Seau à glace
Cubitera hielo

| art. | Ø cm. | h. cm. | lt. | col. | € |
|----------|-------|--------|-----|------|-------|
| 41513G20 | 15 | 14 | 2 | ● | 23,42 |
| 41513C20 | 15 | 14 | 2 | ● | 23,42 |
| 41513B20 | 15 | 14 | 2 | ● | 23,42 |



SS

Ice bucket, antique

Secchio ghiaccio, antique
Eisbehälter, Antique
Seau à glace, antique
Cubitera hielo, antique

| art. | Ø cm. | h. cm. | lt. | € |
|----------|-------|--------|-----|-------|
| 41513A20 | 15 | 14 | 2 | 23,42 |



Bar organizer

Porta oggetti da bar
Bar-Behälter
Présentoir de bar
Dispensador bar

| art. | dim. cm. | € |
|----------|------------|------|
| 44102-24 | 24x14,5x11 | 8,44 |



ABS

Smoking gun

Affumicatore
Räuchergerät
Pistolet à fumer
Ahumador aromatizador

| art. | dim. cm. | € |
|----------|---------------|-------|
| 49923-00 | 16,2x5,5x12,5 | 78,49 |

DC6V - 3,0L/min. Ideal for flavoring and smoking liquid and solid products, such as: cocktails, vegetables, meat and fish. – Ideale per aromatizzare e affumicare prodotti liquidi e solidi, come: cocktail, verdure, carne e pesce.



Smoking chips

Segatura aromatizzata
Aromatisiertes Sägemehl
Sciure aromatisée
Serrín aromatizado

| art. | ml. | € |
|----------|-------|-------|
| 49923-99 | 4x250 | 38,79 |

Mesquite/Hickory/Oak/Cherry. – Mesquite/Hickory/Rovere/Ciliegio.



Cocktail cover

Cloche per affumicatore
Cocktail Räucherglocke
Cloche à fumée
Campana para ahumado

| art. | Ø cm. | h. cm. | € |
|----------|-------|--------|-------|
| 49923-01 | 12 | 11 | 42,91 |
| 49923-02 | 12 | 16 | 47,84 |

**Glass cover, wood base ø 15 cm.
Cloche vetro, base legno ø 15 cm.**



PC

Cocktail cover

Cloche per affumicatore
Cocktail Räucherglocke
Cloche à fumée
Campana para ahumado

| art. | Ø cm. | h. cm. | € |
|----------|-------|--------|-------|
| 49924-21 | 21 | 17 | 28,44 |
| 49924-31 | 30 | 22 | 47,13 |
| 49924-36 | 36 | 27 | 78,69 |



Skull dash bottle

Bottiglia angostura teschio
Schädel Dash Bottle
Dash bottle crâne
Dash bottle cráneo

| art. | ml. | € |
|----------|-----|------|
| 41680-03 | 30 | 3,72 |
| 41680-06 | 60 | 4,32 |
| 41680-12 | 120 | 5,23 |



Atomizer dash bottle

Bottiglia angostura spray
Bitter Flasche Atomizer
Vaporisateur d'angostura
Botella angostrura spray

| art. | ml. | € |
|----------|-----|-------|
| 41681-10 | 100 | 13,17 |



Atomizer dash bottle

Bottiglia angostura spray
Bitter Flasche Atomizer
Vaporisateur d'angostura
Botella angostrura spray

| art. | h. cm. | ml. | € |
|----------|--------|-----|-------|
| 41681-11 | 15 | 50 | 12,26 |



Atomizer dash bottle

Bottiglia angostura spray
Bitter Flasche Atomizer
Vaporisateur d'angostura
Botella angostrura spray

| art. | Ø cm. | h. cm. | ml. | col. | € |
|----------|-------|--------|-----|------|-------|
| 41681-12 | 7 | 10 | 100 | ● | 15,18 |



Atomizer dash bottle

Bottiglia angostura spray
Bitter Flasche Atomizer
Vaporisateur d'angostura
Botella angostrura spray

| art. | Ø cm. | h. cm. | ml. | col. | € |
|----------|-------|--------|-----|------|-------|
| 41681-13 | 3,4 | 9,6 | 100 | ● | 14,47 |





Dash bottle

Bottiglia angostura
Bitter Flasche
Dash bottle

Botella angostrura

| art. | ml. | € |
|----------|-----|-------|
| 41681-06 | 150 | 10,15 |



Dash Bottle

Bottiglia angostura
Bitter Flasche
Dash Bottle

Botella Angostrura

| art. | dim. cm. | ml. | € |
|----------|------------|-----|-------|
| 41681-01 | 6,5x6,5x10 | 100 | 13,37 |



Dash Bottle

Bottiglia angostura
Bitter Flasche
Dash Bottle

Botella Angostrura

| art. | Ø cm. | h. cm. | ml. | € |
|----------|-------|--------|-----|-------|
| 41681-03 | 8,5 | 15 | 280 | 18,89 |



Dash Bottle

Bottiglia angostura
Bitter Flasche
Dash Bottle

Botella Angostrura

| art. | dim. cm. | ml. | € |
|----------|----------|-----|-------|
| 41681-02 | 6x5x15 | 200 | 14,27 |

Without pourer. – Senza dosatore.



Dash Bottle

Bottiglia angostura
Bitter Flasche
Dash Bottle

Botella Angostrura

| art. | Ø cm. | h. cm. | ml. | € |
|----------|-------|--------|-----|------|
| 41681-04 | 6,2 | 10 | 100 | 8,74 |

Without pourer. – Senza dosatore.



Bottle pourer

Tappo versatore
Ausgiesser
Bouchon verseur
Tapón vertedor

| art. | € |
|----------|------|
| 41681-99 | 1,51 |



Flair bottle

Flair bottle
Flair bottle
Flair bottle
Flair bottle

| art. | lt. | € |
|----------|------|-------|
| 44108-01 | 0,75 | 21,21 |



Store & pour container

Contentitore versatore
Dosier-Vorratsbehälter, komplett
Bouteille verseuse
Recipiente vertedor

| art. | Ø cm. | h. cm. | lt. | col. | € |
|----------|-------|--------|-----|------|------|
| 44106W05 | 9,0 | 26 | 0,5 | ○ | 5,33 |
| 44106W10 | 9,0 | 33 | 1,0 | ○ | 7,04 |
| 44106W20 | 12,5 | 35 | 2,0 | ○ | 8,54 |
| 44106W25 | 12,5 | 39 | 2,5 | ○ | 9,45 |

PE



Store & pour container

Contentitore versatore
Dosier-Vorratsbehälter, komplett
Bouteille verseuse
Recipiente vertedor

| art. | Ø cm. | h. cm. | lt. | col. | € |
|----------|-------|--------|-----|------|------|
| 44106G05 | 9,0 | 26 | 0,5 | ● | 5,33 |
| 44106G10 | 9,0 | 33 | 1,0 | ● | 7,04 |
| 44106G20 | 12,5 | 35 | 2,0 | ● | 8,54 |
| 44106G25 | 12,5 | 39 | 2,5 | ● | 9,45 |

PE



PE

Store & pour container

Contentitore versatore
Dosier-Vorratsbehälter, komplett
Bouteille verseuse
Recipiente vertedor

| art. | Ø cm. | h. cm. | lt. | col. | € |
|----------|-------|--------|-----|------|------|
| 44106Y05 | 9,0 | 26 | 0,5 | ● | 5,33 |
| 44106Y10 | 9,0 | 33 | 1,0 | ● | 7,04 |
| 44106Y20 | 12,5 | 35 | 2,0 | ● | 8,54 |
| 44106Y25 | 12,5 | 39 | 2,5 | ● | 9,45 |



PE

Store & pour container

Contentitore versatore
Dosier-Vorratsbehälter, komplett
Bouteille verseuse
Recipiente vertedor

| art. | Ø cm. | h. cm. | lt. | col. | € |
|----------|-------|--------|-----|------|------|
| 44106R05 | 9,0 | 26 | 0,5 | ● | 5,33 |
| 44106R10 | 9,0 | 33 | 1,0 | ● | 7,04 |
| 44106R20 | 12,5 | 35 | 2,0 | ● | 8,54 |
| 44106R25 | 12,5 | 39 | 2,5 | ● | 9,45 |



PE

Store & pour container

Contentitore versatore
Dosier-Vorratsbehälter, komplett
Bouteille verseuse
Recipiente vertedor

| art. | Ø cm. | h. cm. | lt. | col. | € |
|----------|-------|--------|-----|------|------|
| 44106O05 | 9,0 | 26 | 0,5 | ● | 5,33 |
| 44106O10 | 9,0 | 33 | 1,0 | ● | 7,04 |
| 44106O20 | 12,5 | 35 | 2,0 | ● | 8,54 |
| 44106O25 | 12,5 | 39 | 2,5 | ● | 9,45 |



PE

Store & pour container

Contentitore versatore
Dosier-Vorratsbehälter, komplett
Bouteille verseuse
Recipiente vertedor

| art. | Ø cm. | h. cm. | lt. | col. | € |
|----------|-------|--------|-----|------|------|
| 44106B05 | 9,0 | 26 | 0,5 | ● | 5,33 |
| 44106B10 | 9,0 | 33 | 1,0 | ● | 7,04 |
| 44106B20 | 12,5 | 35 | 2,0 | ● | 8,54 |
| 44106B25 | 12,5 | 39 | 2,5 | ● | 9,45 |



PE

Storage canister

Contentitore di riserva
Vorratsbehälter
Réipient réserve
Recipiente reserva

| art. | Ø cm. | h. cm. | lt. | col. | € |
|----------|-------|--------|-----|------|------|
| 44107W05 | 9,0 | 9,5 | 0,5 | ○ | 4,02 |
| 44107W10 | 9,0 | 16 | 1,0 | ○ | 5,53 |
| 44107W20 | 12,5 | 20 | 2,0 | ○ | 6,93 |
| 44107W25 | 12,5 | 23 | 2,5 | ○ | 7,74 |



PE

Storage canister

Contentitore di riserva
Vorratsbehälter
Réipient réserve
Recipiente reserva

| art. | Ø cm. | h. cm. | lt. | col. | € |
|----------|-------|--------|-----|------|------|
| 44107G05 | 9,0 | 9,5 | 0,5 | ● | 4,02 |
| 44107G10 | 9,0 | 16 | 1,0 | ● | 5,53 |
| 44107G20 | 12,5 | 20 | 2,0 | ● | 6,93 |
| 44107G25 | 12,5 | 23 | 2,5 | ● | 7,74 |



PE

Storage canister

Contentitore di riserva
Vorratsbehälter
Réipient réserve
Recipiente reserva

| art. | Ø cm. | h. cm. | lt. | col. | € |
|----------|-------|--------|-----|------|------|
| 44107Y05 | 9,0 | 9,5 | 0,5 | ● | 4,02 |
| 44107Y10 | 9,0 | 16 | 1,0 | ● | 5,53 |
| 44107Y20 | 12,5 | 20 | 2,0 | ● | 6,93 |
| 44107Y25 | 12,5 | 23 | 2,5 | ● | 7,74 |



PE

Storage canister

Contentitore di riserva
Vorratsbehälter
Réipient réserve
Recipiente reserva

| art. | Ø cm. | h. cm. | lt. | col. | € |
|----------|-------|--------|-----|------|------|
| 44107R05 | 9,0 | 9,5 | 0,5 | ● | 4,02 |
| 44107R10 | 9,0 | 16 | 1,0 | ● | 5,53 |
| 44107R20 | 12,5 | 20 | 2,0 | ● | 6,93 |
| 44107R25 | 12,5 | 23 | 2,5 | ● | 7,74 |



PE

Storage canister

Contentitore di riserva
Vorratsbehälter
Réipient réserve
Recipiente reserva

| art. | Ø cm. | h. cm. | lt. | col. | € |
|----------|-------|--------|-----|------|------|
| 44107O05 | 9,0 | 9,5 | 0,5 | ● | 4,02 |
| 44107O10 | 9,0 | 16 | 1,0 | ● | 5,53 |
| 44107O20 | 12,5 | 20 | 2,0 | ● | 6,93 |
| 44107O25 | 12,5 | 23 | 2,5 | ● | 7,74 |





PE

Storage canister

Contentitore di riserva
Vorratsbehälter
Récipient réserve
Recipiente reserva

| art. | Ø cm. | h. cm. | lt. | col. | € |
|----------|-------|--------|-----|------|------|
| 44107B05 | 9,0 | 9,5 | 0,5 | ● | 4,02 |
| 44107B10 | 9,0 | 16 | 1,0 | ● | 5,53 |
| 44107B20 | 12,5 | 20 | 2,0 | ● | 6,93 |
| 44107B25 | 12,5 | 23 | 2,5 | ● | 7,74 |



PS

Pouring container cap

Tappo per versatore
Dosier-Behälterstopfen
Bouchon à bouteille verseuse
Tapón para recipiente vertedor

| art. | pcs/pz | € |
|----------|--------|------|
| 44106-12 | 12 | 3,12 |



PS

PP

Condiment holder

Portacondimenti
Bar-Beilagenbehälter
Boîte à condiments
Caja condimentos

| art. | dim. cm. | comp. | € |
|----------|----------|-------|-------|
| 44103-03 | 49x15x9 | 3 | 26,23 |
| 44103-04 | 49x15x9 | 4 | 26,23 |
| 44103-06 | 49x15x9 | 6 | 26,23 |



SS

Condiment holder

Portacondimenti
Bar-Beilagenbehälter
Boîte à condiments
Caja condimentos

| art. | dim. cm. | comp. | € |
|----------|----------|-------|-------|
| 41782-04 | 32x16x10 | 4 | 29,45 |
| 41782-05 | 39x16x10 | 5 | 33,06 |
| 41782-06 | 47x16x10 | 6 | 38,39 |

Inserts in PP. – Inserti in PP.



Glass rimmer

Bordatore bicchieri
Bar-Kombination Salz-/Zuckerumrand
Système de girvage de verres
Ribeteador de vasos

| art. | Ø cm. | € |
|----------|-------|-------|
| 44101-03 | 15,5 | 11,86 |



PE

Bar liner

Tappeto sottobicchieri
Gläsermatte
Revêtement de bar
Tapete para vasos

| art. | dim. cm. | € |
|----------|----------|--------|
| 44099-03 | 60x1300 | 151,05 |

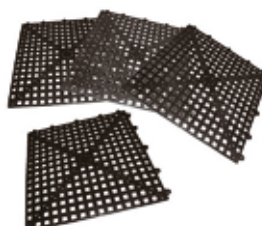

Bar mat, non-slip

Tappeto antiscivolo componibile
Gläserabstellmatte, rutschfest
Tapis antidérapant, composable
Alfombra antiderrapante, componible

| art. | dim. cm. | € |
|----------|----------|------|
| 44100-04 | 30x30 | 6,03 |



Bar runner

Tappetino bar
Gläserabstellmatte
Tapis à verres
Tapete para vasos

| art. | dim. cm. | € |
|----------|----------|-------|
| 44100-01 | 68x8 | 10,95 |
| 44100-02 | 45x30 | 17,89 |



Barman's set, 20 pcs

Valigia Barman, 20 pz
Barman-Koffer, 20 Stk.
Mallette de barman, 20 pièces
Alfombra, 20 piezas

| art. | € |
|----------|--------|
| 14480-20 | 332,35 |

Incl. / Comprende: 41479-05 boston shaker, 41480-05 shaker, 41503-22 pestello/ice beater, 41595-20 cucchiaio magico/magic spoon, 41603-00 colino/strainer, 41604-00 misurino/measuring cup, 41605-00 miscelatore/mixing spoon, 41606-00 & 41606-01 spremilimone/lemon squeezer, 41606-02 spremi lime/lime squeezer, 41608-04 tappo/champagne stopper, 41699-06 cavatappi/corkscrew, 44058-10 tappo dosatore/dispenser plug 10ml, 48280-02 levacapsule/bottle opener, 48280-97 coltello barman/barman knife, 48280-92 rigalimoni/lemon striper, 48280-96 pelarance/orange peeler, 12550-04 cucchiaio ghiaccio/ice spoon, 12550-36 cucchiaio bibita/cocktail spoon, 12550-55 molla ghiaccio/ice tong.



Barman apron

Grembiule barman
Barman Schurz
Tablier barman
Mandil barman

| art. | dim. cm. | col. | € |
|----------|----------|------|-------|
| 48543-01 | 70x40 | ● | 10,65 |
| 48543-02 | 70x40 | ● | 12,26 |

65% polyester/poliestere. – 35% cotton/cotone. 195 g/mq.



SS

Speed rack

Rastrelliera
Flaschenregal
Rack à bouteilles
Estantería bar para botellas

| art. | dim. cm. | bot. | € |
|----------|------------|------|--------|
| 44060-51 | 56x21x15,5 | 2x 6 | 117,89 |



SS

Speed rack

Rastrelliera
Flaschenregal
Rack à bouteilles
Estantería bar para botellas

| art. | dim. cm. | bot. | € |
|----------|---------------|------|--------|
| 44060-50 | 56x10,5x15,5 | 6 | 56,38 |
| 44060-80 | 81x10,5x15,5 | 8 | 88,84 |
| 44060-99 | 107x10,5x15,5 | 10 | 111,76 |





SS

Glass shelf rack

Rastrelliera, fissaggio sospeso
Gläserhalter Regalmontage
Rack à verres fixation suspendue
Rack de copas, fijación techo

| art. | dim. cm. | € |
|----------|-------------|-------|
| 44060-01 | 45x31,6x5,5 | 52,86 |



SS

Glass wall rack

Rastrelliera, fissaggio murale
Gläserhalter Wandmontage
Rack à verres fixation murale
Rack de copas, fijación mural

| art. | dim. cm. | € |
|----------|-------------|-------|
| 44060-02 | 45x31,6x5,6 | 55,28 |



SS

Glass cleaning brush

Lavabicchieri
Gläserpüler
Brosse lave-verres
Cepillo lavavasos

| art. | dim. cm. | € |
|----------|----------|--------|
| 44135-02 | 38x18x29 | 333,56 |



Glass cleaning brush, nylon

Spazzole lavabicchieri, nylon
Bierglasbürstenständer, nylon
Brosse lave-verres, nylon
Cepillo lavavasos, nilón

| art. | h. cm. | € |
|----------|--------|-------|
| 44130-02 | 16,5 | 13,87 |
| 44130-03 | 21,5 | 16,58 |



Glass cleaning brush, nylon-aluminum

Spazzola lavabicchieri, nylon-alluminio
Bierglasbürstenständer, Nylon-Aluminium
Brosse lave-verres, nylon-alu
Cepillo lavavasos, nilón-aluminio

| art. | Ø cm. | h. cm. | € |
|----------|-------|--------|-------|
| 44130-01 | 15 | 19 | 20,70 |



Aluminum wall mounted bottle rack

Supporto a parete, alluminio
Alu-Wandständer
Support pour bouteilles en aluminium
Soporte mural, aluminio

| art. | l. cm. | bot. | € |
|----------|--------|------|--------|
| 44056-04 | 41 | 4 | 120,70 |
| 44056-06 | 67 | 6 | 166,63 |

Dispensers not included. – Dosatori non inclusi.



Revolving bottle rack

Supporto rotante da banco
Theken-Drehständer vollständig
Support rotatif de comptoir
Soporte giratorio

| art. | h. cm. | bot. | € |
|----------|--------|------|--------|
| 44057-04 | 70 | 4 | 462,50 |
| 44057-06 | 70 | 6 | 492,45 |

Dispensers not included. – Dosatori non inclusi.



Standard aluminum support

Supporto bottiglia, alluminio
Alu-Standard Ständer,
Support en aluminium
Soporte de botella, aluminio

| art. | col. | € |
|----------|------|-------|
| 44056-01 | ● | 22,41 |
| 44056-11 | ● | 30,75 |
| 44056-21 | ● | 24,22 |

Universal fitting, shelf or wall mounting.
Fissaggio universale, a ripiano o parete.



Chrome plated dispenser

Dosatore cromato
Verchromter Dosierer
Doseur chromé
Dosificador cromado

| art. | ml. | € |
|----------|-----|-------|
| 44055-10 | 10 | 38,39 |
| 44055-50 | 50 | 38,39 |



Chrome plated dispenser

Dosatore cromato
Verchromter Dosierer
Doseur chromé
Dosificador cromado

| art. | ml. | € |
|----------|-----|-------|
| 44055-20 | 20 | 32,76 |
| 44055-25 | 25 | 32,76 |
| 44055-30 | 30 | 32,76 |
| 44055-35 | 35 | 32,76 |
| 44055-40 | 40 | 32,76 |



Dispenser

Dosatore
Dosierer
Doseur
Dosificador

| art. | ml. | col. | € |
|----------|-----|------|-------|
| 44055G30 | 30 | ● | 47,54 |
| 44055G40 | 40 | ● | 47,54 |
| 44055C30 | 30 | ● | 51,26 |
| 44055C40 | 40 | ● | 51,26 |



Automatic dispenser plug

Tappo dosatore automatico
Automatischer Portionierer
Bouchon doseur automatique
Bola dosificadora

| art. | ml. | € |
|----------|-----|-------|
| 44058-20 | 20 | 14,77 |
| 44058-25 | 25 | 14,77 |
| 44058-30 | 30 | 15,48 |



Automatic dispenser plug

Tappo dosatore automatico
Automatischer Portionierer
Bouchon doseur automatique
Bola dosificadora

| art. | ml. | € |
|----------|-----|-------|
| 44058-10 | 10 | 16,88 |
| 44058-40 | 40 | 16,88 |
| 44058-50 | 50 | 16,98 |



Bottle pourer with cap

Tappo versatore con chiusura
Ausgießer mit Kappe
Bouchon avec clapet
Tapón vertedor con clerre

| art. | pcs/pz | € |
|----------|--------|------|
| 44111-02 | 2 | 6,23 |

SS





Free flow pourer

Tappo versatore continuo
Permanentenausgiesser
Bouchon verseur continu
Vertedor continuo

| art. | pcs/pz | col. | € |
|----------|--------|------|------|
| 44110-01 | 12 | ● | 3,32 |
| 44110-02 | 12 | ● | 3,32 |
| 44110-03 | 12 | ● | 3,32 |



Free flow pourer

Tappo versatore continuo
Permanentenausgiesser
Bouchon verseur continu
Vertedor continuo

| art. | pcs/pz | col. | € |
|----------|--------|------|------|
| 44110-04 | 12 | ● | 3,32 |
| 44110-05 | 12 | ○ | 3,32 |
| 44110-06 | 12 | ● | 3,32 |



Free flow pourer

Tappo versatore continuo
Permanentenausgiesser
Bouchon verseur continu
Vertedor continuo

| art. | pcs/pz | € |
|----------|--------|------|
| 44110-00 | 12 | 3,32 |



Pourer

Tappo versatore
Ausgiesser
Bouchon verseur
Tapón vertedor

| art. | U. Pack | col. | € |
|----------|---------|------|------|
| 44119-01 | 6 | ● | 3,12 |
| 44119-02 | 6 | ● | 3,12 |
| 44119-03 | 6 | ● | 3,12 |
| 44119-04 | 6 | ● | 3,12 |
| 44119-06 | 6 | ● | 3,12 |



Pourer

Tappo versatore
Ausgiesser
Bouchon verseur
Tapón vertedor

| art. | € |
|----------|------|
| 44114-01 | 2,21 |
| 44114-02 | 2,21 |
| 44114-03 | 2,21 |



Pourer set 3 pcs

Tappo versatore set 3 pz
Ausgiesser Satz 3 Stk
Bouchon verseur set 3 pcs
Tapón vertedor 3 piezas

| art. | col. | € |
|----------|------|------|
| 44114G03 | ● | 8,94 |
| 44114C03 | ● | 8,94 |



Measure pourer

Tappo metrico
Portioniererausgiesser
Bouchon doseur
Caños dosificador

| art. | ml. | U. Pack | col. | € |
|----------|-----|---------|------|------|
| 44118-10 | 10 | 6 | ● | 4,22 |
| 44118-20 | 20 | 6 | ● | 4,22 |
| 44118-25 | 25 | 6 | ● | 4,22 |
| 44118-30 | 30 | 6 | ● | 4,22 |



Measure pourer

Tappo metrico
Portioniererausgiesser
Bouchon doseur
Caños dosificador

| art. | ml. | U. Pack | col. | € |
|----------|-----|---------|------|------|
| 44118-35 | 35 | 6 | ● | 4,22 |
| 44118-40 | 40 | 6 | ● | 4,22 |
| 44118-50 | 50 | 6 | ○ | 4,22 |



Whiskey pourer

Tappo versatore
Ausgiesser
Bouchon verseur
Vertedor

| art. | pcs/pz | col. | € |
|----------|--------|------|-------|
| 44112-01 | 12 | ● | 10,95 |
| 44112-02 | 12 | ○ | 10,95 |



Champagne stopper
Tappo spumante
Sektflaschenstopfen
Bouchon à champagne
Tapón Champaña

| art. | € |
|----------|------|
| 41608-20 | 7,44 |



Champagne stopper, chrome plated
Tappo spumante, cromato
Sektflaschenstopfen, verchromt
Bouchon à champagne chromé
Tapón Champaña cromado

| art. | € |
|----------|------|
| 41608-04 | 7,34 |



Champagne stopper
Tappo spumante
Sektflaschenstopfen
Bouchon à champagne
Tapón Champaña

| art. | col. | € |
|----------|------|------|
| 41608G04 | ● | 7,94 |
| 41608C04 | ● | 7,94 |



SS

Champagne stopper
Tappo spumante
Sektflaschenstopfen
Bouchon à champagne
Tapón Champaña

| art. | € |
|----------|-------|
| 46796-00 | 16,38 |



SS

Wine stopper
Tappo vino
Weinflaschenstopfen
Bouchon à vin
Tapón vino

| art. | € |
|----------|-------|
| 41608-03 | 14,37 |



SS

ABS

Vacuum pump wine preserver + 2 stoppers
Pompa sottovuoto per vino + 2 tappi
Wein-Vakuum-Pumpe + 2 Stopfen
Pompe à vide d'air + 2 bouchons
Bomba vacío vino + 2 tapones

| art. | € |
|----------|-------|
| 41500-00 | 12,56 |



Set 2 stoppers
Set 2 tappi
Satz 2 Stopfen
Jeu 2 bouchons
Juego 2 tapones

| art. | € |
|----------|------|
| 41500-AA | 4,22 |



Foil cutter
Taglia capsula
Folienschneider
Coupe-capsules
Cortacápsulas

| art. | € |
|----------|------|
| 49858-07 | 2,61 |



Winged corkscrew
Cavatappi a doppia leva
Korkenzieher mit Doppelhebel
Tire-bouchon à double levier
Sacacorchos a doble palanca

| art. | € |
|----------|-------|
| 41699-10 | 20,70 |

Zinc alloy, chromed. – Cromato.



Waiter's corkscrew
Cavatappi cameriere
Kellner Korkenzieher
Tire-bouchon sommelier
Sacacorchos camarero

| art. | € |
|----------|------|
| 41699-20 | 8,34 |



Waiter's corkscrew
Cavatappi cameriere
Kellner Korkenzieher
Tire-bouchon sommelier
Sacacorchos camarero

| art. | € |
|----------|------|
| 41699-06 | 3,92 |



Bottle opener with collector box
Levacapsule con contenitore di raccolta
Flaschenöffner mit Sammelbehälter
Décapsuleur avec récipient de récupération
Abridor de botellas + caja de recuperación

| art. | dim. cm. | € |
|----------|----------|-------|
| 48223-00 | 12x7x30 | 45,63 |

BAR HAPPY HOUR



SS

Bottle opener
Levacapsule
Flaschenöffner
Décapsuleur
Abrebotellas

| art. | dim. cm. | col. | € |
|----------|----------|------|------|
| 41699-18 | 18x4 | ● | 4,32 |
| 41699G18 | 18x4 | ● | 6,03 |
| 41699C18 | 18x4 | ● | 6,03 |
| 41699B18 | 18x4 | ● | 6,03 |



SS

Bottle opener
Levacapsule
Flaschenöffner
Décapsuleur
Abrebotellas

| art. | dim. cm. | € |
|----------|----------|------|
| 41699-12 | 11x4 | 3,52 |



SS

Bottle opener
Levacapsule
Flaschenöffner
Décapsuleur
Abrebotellas

| art. | dim. cm. | € |
|----------|----------|------|
| 41699-04 | 11x4 | 7,54 |



Bar blade holster with belt clip
Fondina per levacapsule
Flaschenöffner-Halter
Etui pour décapsuleur
Funda para abrebotellas

| art. | dim. cm. | € |
|----------|----------|-------|
| 41699-13 | 11x4 | 23,32 |



Bottle opener, nickelplated
Levacapsule nichelato
Flaschenöffner, vernickelt
Décapsuleur, nickelé
Abrebotellas, niquelado

| art. | € |
|----------|------|
| 41699-03 | 1,51 |



SS

Etlund

Can punch and bottle opener
Apriscatole/levacapsule
Dosen-/Flaschenöffner
Ouvre-boîte/décapsuleur
Abrelatas/botellas

| art. | € |
|----------|-------|
| 49860-00 | 40,40 |



B

Tepokushi skewers
Spiedini tepokushi
Tepokushi Spieße
Brochettes tepokushi
Pinchos tepokushi

| art. | l. cm. | pcs/pz | € |
|----------|--------|--------|------|
| 48300-43 | 9 | 100 | 1,91 |
| 48300-33 | 15 | 100 | 2,41 |



B

Noshikushi skewers
Spiedini noshikushi
Noshikushi Spieße
Brochettes noshikushi
Pinchos noshikushi

| art. | l. cm. | pcs/pz | € |
|----------|--------|--------|------|
| 48300-42 | 10,5 | 100 | 4,12 |



W

Toothpicks
Stuzzicadenti
Zahnstocher
Cure-dents
Palillos

| art. | l. cm. | pcs/pz | € |
|----------|--------|--------|------|
| 48306-01 | 9 | 1000 | 6,23 |

Birch, double pointed, individually wrapped.
Betulla, 2 punte, imbustati singolarmente.



SS

Cocktail picks, 4 pcs
Spiedini cocktail, 4 pz
Cocktailspiese, 4 Stk
Brochettes, 4 pièces
Palos, 4 piezas

| art. | l. cm. | col. | € |
|----------|--------|------|------|
| 41492-00 | 10 | ● | 4,92 |
| 41492G00 | 10 | ● | 6,23 |
| 41492C00 | 10 | ● | 6,23 |
| 41492B00 | 10 | ● | 6,23 |



PC

Glass clip holder
Clip reggibicchieri
Glashalter
Clip porte-verre
Soporte para vidrio

| art. | U. Pack | € |
|----------|---------|------|
| 44048-99 | 100 | 1,31 |



PP

Non-slip tray, round

Vassoio antiscivolo, rotondo
Tablett, rutschfest, rund
Plateau antidérapant, rond
Bandeja antideslizante, redonda

| art. | Ø cm. | € |
|----------|-------|------|
| 41863-35 | 35 | 4,22 |



PP

Non-slip tray, oval

Vassoio antiscivolo, ovale
Tablett, rutschfest, oval
Plateau antidérapant, ovale
Bandeja antideslizante, oval

| art. | dim. cm. | € |
|----------|----------|-------|
| 41864-56 | 56x68 | 16,18 |



PP

Non-slip tray, rectangular

Vassoio antiscivolo, rettangolare
Tablett, rutschfest, rechteckig
Plateau antidérapant, rectangulaire
Bandeja antideslizante, rectangular

| art. | dim. cm. | € |
|----------|----------|-------|
| 41865-40 | 41x56,5 | 11,16 |



PP

Fast food tray

Vassoio fast food
Serviertablett, Fast Food
Plateau fast food
Bandeja fast food

| art. | dim. cm. | € |
|----------|-----------|------|
| 41860-36 | 27x36,5 | 4,32 |
| 41860-43 | 30,7x43,5 | 6,03 |
| 41860-47 | 35,5x47 | 6,63 |



PP

Fast food tray

Vassoio fast food
Serviertablett, Fast Food
Plateau fast food
Bandeja fast food

| art. | dim. cm. | € |
|----------|----------|------|
| 41861-44 | 30,7x44 | 6,73 |



PP

Gastronorm tray

Vassoio Gastronorm
Serviertablett, Gastronorm
Plateau Gastronorm
Bandeja Gastronorm

| art. | dim. cm. | col. | € |
|----------|-------------|------|-------|
| 41862B11 | 53x32,5x1,6 | ● | 12,86 |
| 41862C11 | 53x32,5x1,6 | ● | 12,86 |
| 41862G11 | 53x32,5x1,6 | ● | 12,86 |



PP

Euronorm tray

Vassoio Euronorm
Serviertablett, Euronorm
Plateau Euronorm
Bandeja Euronorm

| art. | dim. cm. | col. | € |
|----------|-----------|------|-------|
| 41862B53 | 53x37x1,6 | ● | 13,37 |
| 41862C53 | 53x37x1,6 | ● | 13,37 |
| 41862G53 | 53x37x1,6 | ● | 13,37 |



PADERNO®

WORLD CUISINE

THE ART OF
MIXOLOGY
Bar Collection

Paderno offers a selection of bar tools for mixology enthusiasts in the trendy Gold and Copper colors. Each set comes with a stylish packaging. Designed as perfect gift ideas.

Paderno propone una selezione di utensili bar per gli appassionati del mixology nelle colorazioni di tendenza Gold e Copper. Ogni set ha un packaging con grafica raffinata. Pensati come perfette idee regalo.





Set 2 Martini cups

Set coppe Martini 2 pz
Set Martini Gläser 2 Stk
Set verres à Martini 2 pcs
Set copas Martini 2 pz

| art. | col. | € |
|----------|------|-------|
| 41494-C2 | ● | 36,98 |



Set 2 Martini cups

Set coppe Martini 2 pz
Set Martini Gläser 2 Stk
Set verres à Martini 2 pcs
Set copas Martini 2 pz

| art. | col. | € |
|----------|------|-------|
| 41494-G2 | ● | 36,98 |



Set 2 Champagne Glasses

Set flûte Champagne 2 pz
Set Champagne Gläser 2 Stk
Set verres à Champagne 2 pcs
Set copas Champagne 2 pz

| art. | col. | € |
|----------|------|-------|
| 41493-C2 | ● | 32,86 |



Set 2 Champagne Glasses

Set flûte Champagne 2 pz
Set Champagne Gläser 2 Stk
Set verres à Champagne 2 pcs
Set copas Champagne 2 pz

| art. | col. | € |
|----------|------|-------|
| 41493-G2 | ● | 32,86 |



Martini set 3 pcs

Set mixology 3 pz, Martini
Set Mixology 3 Stk, Martini
Set mixology 3 pcs, Martini
Set mixology 3 pz, Martini

| art. | col. | € |
|----------|------|-------|
| 41494-C3 | ● | 57,59 |



Martini set 3 pcs

Set mixology 3 pz, Martini
Set Mixology 3 Stk, Martini
Set mixology 3 pcs, Martini
Set mixology 3 pz, Martini

| art. | col. | € |
|----------|------|-------|
| 41494-G3 | ● | 57,59 |



Mixology set 3 pcs, Starter

Set mixology 3 pz, Starter
Set Mixology 3 Stk, Starter
Set mixology 3 pcs, Starter
Set mixology 3 pz, Starter

| art. | col. | € |
|----------|------|-------|
| 41484-C3 | ● | 41,10 |



Mixology set 3 pcs, Starter

Set mixology 3 pz, Starter
Set Mixology 3 Stk, Starter
Set mixology 3 pcs, Starter
Set mixology 3 pz, Starter

| art. | col. | € |
|----------|------|-------|
| 41484-G3 | ● | 41,10 |





Mixology set 4 pcs, Parisian

Set mixology 4 pz, Parisian
Set Mixology 4 Stk, Parisian
Set mixology 4 pcs, Parisian
Set mixology 4 pz, Parisian

| art. | col. | € |
|----------|------|-------|
| 41461-C4 | ● | 57,59 |



Mixology set 4 pcs, Parisian

Set mixology 4 pz, Parisian
Set Mixology 4 Stk, Parisian
Set mixology 4 pcs, Parisian
Set mixology 4 pz, Parisian

| art. | col. | € |
|----------|------|-------|
| 41461-G4 | ● | 57,59 |



Mixology set 5 pcs, Boston

Set mixology 5 pz, Boston
Set Mixology 5 Stk, Boston
Set mixology 5 pcs, Boston
Set mixology 5 pz, Boston

| art. | col. | € |
|----------|------|-------|
| 41467-C5 | ● | 65,83 |



Mixology set 5 pcs, Boston

Set mixology 5 pz, Boston
Set Mixology 5 Stk, Boston
Set mixology 5 pcs, Boston
Set mixology 5 pz, Boston

| art. | col. | € |
|----------|------|-------|
| 41467-G5 | ● | 65,83 |



Mixology set 5 pcs, Crystal

Set mixology 5 pz, Crystal
Set Mixology 5 Stk, Crystal
Set mixology 5 pcs, Crystal
Set mixology 5 pz, Crystal

| art. | col. | € |
|----------|------|-------|
| 41514-C5 | ● | 65,83 |



Mixology set 5 pcs, Crystal

Set mixology 5 pz, Crystal
Set Mixology 5 Stk, Crystal
Set mixology 5 pcs, Crystal
Set mixology 5 pz, Crystal

| art. | col. | € |
|----------|------|-------|
| 41514-G5 | ● | 65,83 |



Mixology set 5 pcs, Parisian

Set mixology 5 pz, Parisian
Set Mixology 5 Stk, Parisian
Set mixology 5 pcs, Parisian
Set mixology 5 pz, Parisian

| art. | col. | € |
|----------|------|-------|
| 41461-C5 | ● | 57,59 |



Mixology set 5 pcs, Parisian

Set mixology 5 pz, Parisian
Set Mixology 5 Stk, Parisian
Set mixology 5 pcs, Parisian
Set mixology 5 pz, Parisian

| art. | col. | € |
|----------|------|-------|
| 41461-G5 | ● | 57,59 |



Mixology set 6 pcs, Ice

Set mixology 6 pz, Ice
Set Mixology 6 Stk, Ice
Set mixology 6 pcs, Ice
Set mixology 6 pz, Ice

| art. | col. | € |
|----------|------|-------|
| 41461-C6 | ● | 78,19 |



Mixology set 6 pcs, Ice

Set mixology 6 pz, Ice
Set Mixology 6 Stk, Ice
Set mixology 6 pcs, Ice
Set mixology 6 pz, Ice

| art. | col. | € |
|----------|------|-------|
| 41461-G6 | ● | 78,19 |



Mixology set 8 pcs, Cobbler

Set mixology 8 pz, Cobbler
Set Mixology 8 Stk, Cobbler
Set mixology 8 pcs, Cobbler
Set mixology 8 pz, Cobbler

| art. | col. | € |
|----------|------|-------|
| 41480-C8 | ● | 61,71 |



Mixology set 8 pcs, Cobbler

Set mixology 8 pz, Cobbler
Set Mixology 8 Stk, Cobbler
Set mixology 8 pcs, Cobbler
Set mixology 8 pz, Cobbler

| art. | col. | € |
|----------|------|-------|
| 41480-G8 | ● | 61,71 |



BAR HAPPY HOUR

APPETIZERS
AMUSE-BOUCHE



SS

Snack holder
Porta snack
Snack-Behälter
Conteneur à snack
Contenedor para snack

| art. | Ø cm. | h. cm. | lt. | € |
|----------|-------|--------|------|------|
| 41524-09 | 9 | 8,5 | 0,33 | 8,04 |



SS

Snack holder, 4 pcs
Porta snack, 4 pz
Snack-Behälter, 4 Stk
Conteneur à snack, 4 pcs
Contenedor para snack, 4 pz

| art. | Ø cm. | h. cm. | lt. | € |
|----------|-------|--------|------|-------|
| 41524-04 | 7 | 6,5 | 0,15 | 22,71 |



SS

Snack holder
Porta snack
Snack-Behälter
Conteneur à snack
Contenedor para snack

| art. | dim. cm. | € |
|----------|------------|-------|
| 41527-12 | 10x8,5x6,5 | 7,94 |
| 41527-13 | 13x10,5x9 | 10,35 |



SS

Snack holder
Porta snack
Snack-Behälter
Conteneur à snack
Contenedor para snack

| art. | dim. cm. | € |
|----------|---------------|-------|
| 41527-10 | 21,5x10,5x4,5 | 26,03 |
| 41527-11 | 26x13x5 | 30,75 |



SS

Snack holder
Porta snack
Snack-Behälter
Conteneur à snack
Contenedor para snack

| art. | Ø cm. | h. cm. | € |
|----------|-------|--------|------|
| 41523-08 | 8 | 7,5 | 7,74 |
| 41523-09 | 9 | 8,5 | 9,45 |



SS

Snack holder
Mini tegame
Mini-Servierfanne
Conteneur à snack
Contenedor para snack

| art. | dim. cm. | lt. | € |
|----------|--------------|-----|-------|
| 41522-14 | 14,5x9,5x4,5 | 0,5 | 17,79 |



SS
PVD

Snack holder

Porta snack
Snack-Behälter
Conteneur à snack
Contenedor para snack

| art. | dim. cm. | col. | € |
|----------|---------------|------|-------|
| 41527G10 | 21,5x10,5x4,5 | ● | 30,75 |
| 41527G11 | 26x13x5 | ● | 35,48 |



SS
PVD

Snack holder

Porta snack
Snack-Behälter
Conteneur à snack
Contenedor para snack

| art. | dim. cm. | col. | € |
|----------|------------|------|-------|
| 41527G12 | 10x8,5x6,5 | ● | 27,64 |
| 41527G13 | 13x10,5x9 | ● | 33,77 |



SS
PVD

Snack holder

Porta snack
Snack-Behälter
Conteneur à snack
Contenedor para snack

| art. | Ø cm. | h. cm. | col. | € |
|----------|-------|--------|------|-------|
| 41523G08 | 8 | 7,5 | ● | 19,90 |
| 41523G09 | 9 | 8,5 | ● | 23,01 |



SS

Snack holder

Porta snack
Snack-Behälter
Conteneur à snack
Contenedor para snack

| art. | Ø cm. | h. cm. | lt. | € |
|----------|-------|--------|------|------|
| 41524-10 | 9,5 | 11,5 | 0,45 | 9,85 |



SS

Snack holder

Porta snack
Snack-Behälter
Conteneur à snack
Contenedor para snack

| art. | Ø cm. | h. cm. | lt. | € |
|----------|-------|--------|------|------|
| 41524-11 | 8,5 | 8,5 | 0,35 | 7,04 |



SS

Snack holder

Porta snack
Snack-Behälter
Conteneur à snack
Contenedor para snack

| art. | Ø cm. | h. cm. | lt. | € |
|----------|-------|--------|------|------|
| 41524-12 | 8,5 | 8,5 | 0,35 | 7,74 |



SS
PVD

Snack holder

Porta snack
Snack-Behälter
Conteneur à snack
Contenedor para snack

| art. | Ø cm. | h. cm. | lt. | col. | € |
|----------|-------|--------|------|------|-------|
| 41524C10 | 9,5 | 11,5 | 0,45 | ● | 10,95 |



SS
PVD

Snack holder

Porta snack
Snack-Behälter
Conteneur à snack
Contenedor para snack

| art. | Ø cm. | h. cm. | lt. | col. | € |
|----------|-------|--------|------|------|------|
| 41524C11 | 8,5 | 8,5 | 0,35 | ● | 8,04 |



SS
PVD

Snack holder

Porta snack
Snack-Behälter
Conteneur à snack
Contenedor para snack

| art. | Ø cm. | h. cm. | lt. | col. | € |
|----------|-------|--------|------|------|------|
| 41524C12 | 8,5 | 8,5 | 0,35 | ● | 9,05 |



NEW

Snack holder

Ciotola porta snack
Snack-Schale
Bol à snack
Cuenco para snack

| art. | dim. cm. | lt. | col. | € |
|----------|-------------|-----|------|-------|
| 41532G15 | 15,5x12x5,5 | 0,7 | ● | 21,91 |
| 41532G23 | 23x15,5x6 | 1,4 | ● | 32,86 |

Aluminum, hammered surface.
Alluminio, superficie martellata.



NEW

Snack holder

Ciotola porta snack
Snack-Schale
Bol à snack
Cuenco para snack

| art. | dim. cm. | lt. | col. | € |
|----------|-------------|-----|------|-------|
| 41532C15 | 15,5x12x5,5 | 0,7 | ● | 21,91 |
| 41532C23 | 23x15,5x6 | 1,4 | ● | 32,86 |

Aluminum, hammered surface.
Alluminio, superficie martellata.



NEW

Snack holder

Ciotola porta snack
Snack-Schale
Bol à snack
Cuenco para snack

| art. | dim. cm. | lt. | col. | € |
|----------|-------------|-----|------|-------|
| 41532B15 | 15,5x12x5,5 | 0,7 | ● | 21,91 |
| 41532B23 | 23x15,5x6 | 1,4 | ● | 32,86 |

Aluminum, hammered surface.
Alluminio, superficie martellata.



NEW

SS



Snack dispenser

Porta snack
Snackspender
Distributeur de snacks
Dispensador de snacks

| art. | Ø cm. | h. cm. | lt. | col. | € |
|----------|-------|--------|------|------|-------|
| 41521-01 | 8,5 | 15,5 | 0,35 | ● | 12,76 |
| 41521-02 | 8,5 | 15,5 | 0,35 | ● | 12,76 |

Glass container, screw cap, opening oval 3,5x2,5 cm. – Contenitore vetro, tappo a vite, apertura ovale 3,5x2,5 cm.



W

5 pcs tasting/dessert set

Set 5 pz aperitivo/degustazione
5 Stück Verkostung/Dessert Set
Set 5 pcs dégustation/dessert
Juego de degustación/postre 5 pz

| art. | dim. cm. | ml. | € |
|----------|----------|------|-------|
| 41205-07 | 42x9x1,8 | 4x68 | 19,80 |



W

4 pcs canning jar set

Set 4 pz barattoli degustazione
4 Stück Verkostung-Gläser Set
Set 4 pcs dégustation/dessert
Juego de degustación/postre 4 pz

| art. | dim. cm. | ml. | € |
|----------|-----------|-------|-------|
| 41205-08 | 27,5x11x4 | 3x200 | 17,29 |



W

7 pcs canning jar set

Set 7 pz barattoli degustazione
5 Stück Verkostung-Gläser Set
Set 7 pcs dégustation/dessert
Juego de degustación/postre 5 pz

| art. | dim. cm. | ml. | € |
|----------|----------|-------|-------|
| 41205-09 | 43x10x3 | 6x100 | 21,81 |

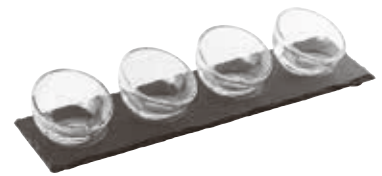

AR

5 pcs tasting/dessert set

Set 5 pz aperitivo/degustazione
5 Stück Verkostung/Dessert Set
Set 5 pcs dégustation/dessert
Juego de degustación/postre 5 pz

| art. | dim. cm. | ml. | € |
|----------|----------|------|-------|
| 41205-01 | 35x10 | 4x43 | 15,98 |



AR

5 pcs tasting/dessert set

Set 5 pz aperitivo/degustazione
5 Stück Verkostung/Dessert Set
Set 5 pcs dégustation/dessert
Juego de degustación/postre 5 pz

| art. | dim. cm. | ml. | € |
|----------|----------|-------|-------|
| 41205-02 | 35x10 | 4x110 | 16,48 |



W

5 pcs tasting/dessert set

Set 5 pz aperitivo/degustazione
5 Stück Verkostung/Dessert Set
Set 5 pcs dégustation/dessert
Juego de degustación/postre 5 pz

| art. | dim. cm. | ml. | € |
|----------|------------|-------|-------|
| 41205-03 | 49x9,7x1,8 | 4x176 | 23,12 |



W

4 pcs tasting/dessert set

Set 4 pz aperitivo/degustazione
4 Stück Verkostung/Dessert Set
Set 4 pcs dégustation/dessert
Juego de degustación/postre 4 pz

| art. | dim. cm. | ml. | € |
|----------|-----------|-------|-------|
| 41205-05 | 45x11x1,8 | 3x147 | 18,59 |



W

4 pcs tasting/dessert set

Set 4 pz aperitivo/degustazione
4 Stück Verkostung/Dessert Set
Set 4 pcs dégustation/dessert
Juego de degustación/postre 4 pz

| art. | dim. cm. | ml. | € |
|----------|-----------|-------|-------|
| 41205-04 | 35x11x1,8 | 3x147 | 16,68 |



W

5 pcs tasting/dessert set

Set 5 pz aperitivo/degustazione
5 Stück Verkostung/Dessert Set
Set 5 pcs dégustation/dessert
Juego de degustación/postre 5 pz

| art. | dim. cm. | € |
|----------|----------|-------|
| 41205-06 | 45x9x1,8 | 21,71 |



W

4 pcs tasting/dessert set

Set 4 pz aperitivo/degustazione

4 Stück Verkostung/Dessert Set

Set 4 pcs dégustation/dessert

Juego de degustación/postre 4 pz

| art. | dim. cm. | € |
|----------|----------|-------|
| 41205-10 | 35x11x2 | 19,90 |



W

7 pcs tasting/dessert set

Set 7 pz aperitivo/degustazione

7 Stück Verkostung/Dessert Set

Set 7 pcs dégustation/dessert

Juego de degustación/postre 7 pz

| art. | dim. cm. | € |
|----------|----------|-------|
| 41206-04 | 38x12x1 | 32,06 |

**TRAYS WOOD EFFECT
VASSOI EFFETTO LEGNO**



MF



GN

Rectangular platter

Vassoio rettangolare

Tablett, Rechteckig

Plateau rectangulaire

Bandeja rectangular

| art. | dim. cm. | € |
|----------|---------------|-------|
| 44473-31 | 53x32,5x0,8 | 45,63 |
| 44473-32 | 32,5x26,5x0,8 | 21,71 |
| 44473-34 | 26x16x0,8 | 8,94 |
| 44473-33 | 32,5x17,5x0,8 | 12,26 |



Round platter

Vassoio rotondo

Tablett, Rund

Plateau rond

Bandeja redonda

| art. | Ø cm. | h. cm. | € |
|----------|-------|--------|-------|
| 44473-02 | 33 | 0,8 | 21,91 |
| 44473-03 | 43 | 0,8 | 38,79 |



Round platter with handle

Vassoio rotondo con manico
Tablett, Rund mit Griff
Plateau rond avec manche
Bandeja redonda con mango

| art. | Ø cm. | h. cm. | € |
|----------|-------|--------|-------|
| 44473-05 | 38 | 1,5 | 32,36 |



Rectangular platter with handle

Vassoio rettangolare con manico
Tablett Rechteckig mit Griff
Plateau rectangulaire avec manche
Bandeja rectangular con mango

| art. | dim. cm. | € |
|----------|-----------|-------|
| 44473-07 | 53x20x1,5 | 23,92 |



Rectangular platter with handle

Vassoio rettangolare con manico
Tablett Rechteckig mit Griff
Plateau rectangulaire avec manche
Bandeja rectangular con mango

| art. | dim. cm. | € |
|----------|-----------|-------|
| 44473-08 | 61x20x1,5 | 24,92 |

WOODEN SERVING BOARDS
TAGLIERI IN LEGNO



Each piece is carefully handcrafted therefore size, shape and finish may vary from piece to piece. Wash by hand with warm soapy water, do not to soak.

Ogni pezzo è realizzato a mano quindi dimensioni, forma e finitura variano da pezzo a pezzo. Lavare a mano con acqua tiepida e sapone. Non mettere in ammollo.



Serving board
Tagliere
Servierbrett
Planche de service
Tabla

| art. | dim. cm. | € |
|----------|----------|-------|
| 41327-01 | 45,5x20 | 40,00 |

Acacia wood. – Acacia.



Bowl
Ciotola
Schüssel
Bol
Bol

| art. | Ø cm. | € |
|----------|-------|-------|
| 41327-02 | 25,5 | 42,51 |

Acacia wood. – Acacia.



Serving board
Tagliere
Servierbrett
Planche de service
Tabla

| art. | Ø cm. | € |
|----------|-------|-------|
| 41327-03 | 20,0 | 18,19 |
| 41327-04 | 25,5 | 22,01 |
| 41327-05 | 30,5 | 25,53 |

Acacia wood. – Acacia.



W

Serving board
Tagliere
Servierbrett
Planche de service
Tabla

| art. | Ø cm. | € |
|----------|-------|-------|
| 41327-06 | 19,5 | 22,61 |
| 41327-07 | 24,0 | 26,63 |
| 41327-08 | 29,5 | 39,50 |

Acacia wood. – Acacia.



W

Serving board
Tagliere
Servierbrett
Planche de service
Tabla

| art. | Ø cm. | € |
|----------|-------|-------|
| 41327-09 | 24 | 25,53 |
| 41327-10 | 30 | 33,27 |

Acacia wood. – Acacia.



W

Serving board
Tagliere
Servierbrett
Planche de service
Tabla

| art. | dim. cm. | € |
|----------|-----------|-------|
| 41320-25 | 25x17x1,5 | 53,97 |

Olive wood. – Ulivo.



W

Serving board
Tagliere
Servierbrett
Planche de service
Tabla

| art. | dim. cm. | l. | € |
|----------|-----------|-------|--------|
| 41321-40 | 40x15x1,5 | 40+11 | 94,57 |
| 41321-44 | 44x20x2 | 44+12 | 121,50 |

Olive wood. – Ulivo.



W

Serving board
Tagliere
Servierbrett
Planche de service
Tabla

| art. | dim. cm. | l. | € |
|----------|-------------|------|-------|
| 41322-19 | 19x12,2x1,5 | 19+6 | 38,79 |
| 41322-25 | 25x16x1,5 | 25+8 | 58,99 |
| 41322-31 | 31x20x1,5 | 31+9 | 87,74 |

Olive wood. – Ulivo.



W

Serving board
Tagliere
Servierbrett
Planche de service
Tabla

| art. | dim. cm. | € |
|----------|----------|-------|
| 41325-20 | 20x12x3 | 16,88 |

Birch wood. – Betulla.



W

Serving board
Tagliere
Servierbrett
Planche de service
Tabla

| art. | dim. cm. | € |
|----------|----------|-------|
| 41325-30 | 30x20x3 | 20,20 |

Birch wood. – Betulla.



W

Serving board
Tagliere
Servierbrett
Planche de service
Tabla

| art. | dim. cm. | € |
|----------|----------|-------|
| 41325-40 | 40x15x3 | 25,02 |

Birch wood. – Betulla.



W

AR

Serving board set 4 pieces
Tagliere set 4 pezzi
Servierbrett, 4-tlg
Planche de service, set 4 pièces
Tabla juego 4 piezas

| art. | dim. cm. | € |
|----------|-----------|-------|
| 41206-01 | 35x23x1,5 | 20,80 |

Pine wood & slate. – Pino & ardesia.



W

AR

Serving board set 3 pieces
Tagliere set 3 pezzi
Servierbrett, 3-tlg
Planche de service, set 3 pièces
Tabla juego 3 piezas

| art. | dim. cm. | € |
|----------|-----------|-------|
| 41206-02 | 37x17x1,8 | 16,28 |

Pine wood & slate. – Pino & ardesia.



NEW

W

AR

Tagliere
Servierbrett
Planche de service
Tabla

| art. | dim. cm. | € |
|----------|----------|-------|
| 41326-26 | 26x18x2 | 23,52 |

Acacia wood & slate. – Acacia & ardesia.

BAR HAPPY HOUR



NEW
W
AR

Tagliere
Servierbrett
Planche de service

| art. | dim. cm. | € |
|----------|----------|-------|
| 41326-33 | 33x20x2 | 28,84 |

Acacia wood & slate. – Acacia & ardesia.



NEW
W
AR

Tagliere
Servierbrett
Planche de service

| art. | dim. cm. | € |
|----------|----------|-------|
| 41326-40 | 40x15x2 | 36,68 |

Acacia wood & slate. – Acacia & ardesia.



NEW
W
AR

Tagliere
Servierbrett
Planche de service

| art. | dim. cm. | € |
|----------|----------|-------|
| 41326-43 | 43x12x2 | 28,84 |

Acacia wood & slate. – Acacia & ardesia.



W

Coffee set 4 pieces
Servizio caffè 4 pezzi
Kaffeaset 4 Stk
Service à café 4 pièces
Servicio de café 4 piezas

| art. | dim. cm. | € |
|----------|-------------|-------|
| 41206-03 | 25x18,7x2,5 | 17,89 |

Acacia wood. – Acacia.



AR
W

Serving board
Tagliere
Servier-Brett
Planche de service
Tabla

| art. | dim. cm. | € |
|----------|-------------|-------|
| 41326-30 | 30,5x13x1,5 | 30,45 |

Acacia wood & slate. – Acacia & ardesia.



AR
W

Serving board
Tagliere
Servier-Brett
Planche de service
Tabla

| art. | dim. cm. | € |
|----------|-------------|-------|
| 41326-36 | 36,5x15x1,5 | 38,79 |

Acacia wood & slate. – Acacia & ardesia.



AR
W

Serving board
Tagliere
Servier-Brett
Planche de service
Tabla

| art. | dim. cm. | € |
|----------|-----------|-------|
| 41326-42 | 42x18x1,5 | 43,92 |

Acacia wood & slate. – Acacia & ardesia.



W
AR

Serving stand 2-tier
Alzata 2 piani
Servierstand 2-stufig
Support 2 niveaux
Soporte 2 pisos

| art. | dim. cm. | € |
|----------|-------------|-------|
| 41207-02 | 25x4,5x34,5 | 39,80 |

Beech. Slate cm. 31x13 - 41x18.
Faggio. Ardesia cm. 31x13 - 41x18.



W
AR

Serving stand 3-tier
Alzata 3 piani
Servierstand 3-stufig
Support 3 niveaux
Soporte 3 pisos

| art. | dim. cm. | € |
|----------|-----------|-------|
| 41207-03 | 25x4,5x54 | 44,92 |

Beech. Slate cm. 21x8 - 31x13 - 41x18.
Faggio. Ardesia cm. 21x8 - 31x13 - 41x18.



W

Serving board with cast iron surface
Tagliere con inserto ghisa
Servierplatte mit Gusseiseneinsatz
Planche à servir avec insert en fonte
Tabla con inserto de hierro fundido

| art. | Ø cm. | Por. | € |
|----------|-------|------|-------|
| 44250S30 | 30 | 1-2 | 98,09 |

Iroko wood. – Iroko.



W

Serving board with cast iron surface
Tagliere con inserto ghisa
Servierplatte mit Gusseiseneinsatz
Planche à servir avec insert en fonte
Tabla con inserto de hierro fundido

| art. | dim. cm. | Por. | € |
|----------|-----------|------|--------|
| 44248S60 | 60x15x2,5 | 4 | 124,62 |

Iroko wood. – Iroko.



W

Serving board with cast iron surface
Tagliere con inserto ghisa
Servierplatte mit Gusseiseneinsatz
Planche à servir avec insert en fonte
Tabla con inserto de hierro fundido

| art. | Ø cm. | h. cm. | Por. | € |
|----------|-------|--------|------|---|
| 44254-30 | 31 | 2,5 | 1 | - |

Iroko wood. – Iroko.



W

Wooden service platter

Tagliere legno
Holzbrett
Planche à servir en bois
Tabla madera

| art. | dim. cm. | Por. | € |
|----------|----------|------|-------|
| 44258-60 | 60x15 | 4-6 | 42,41 |

Iroko wood. – Iroko.



W

Wooden service platter

Tagliere legno
Holzbrett
Planche à servir en bois
Tabla madera

| art. | dim. cm. | Por. | € |
|----------|-----------|------|-------|
| 44264-35 | 25x35x1,8 | 1-2 | 37,08 |

Iroko wood. – Iroko.



W

Wooden service platter

Tagliere legno
Holzbrett
Planche à servir en bois
Tabla madera

| art. | dim. cm. | Por. | € |
|----------|-----------|------|-------|
| 44265-35 | 25x35x1,8 | 1-2 | 37,99 |

Iroko wood. – Iroko.



W

Twice sauce pot wooden platter

Porta coppette doppio
Schale-Träger doppel
Support à bol double
Soporte copa doble

| art. | Ø cm. | dim. cm. | € |
|----------|-------|----------|------|
| 44256-02 | 5,5 | 8x20x1,8 | 9,15 |

Beechwood. – Faggio.



W

Triple sauce pot wooden platter

Porta coppette triplo
Schale-Träger dreifach
Support à bol triple
Soporte copa triple

| art. | Ø cm. | dim. cm. | € |
|----------|-------|----------|------|
| 44256-03 | 5,5 | 8x28x1,8 | 9,15 |

Beechwood. – Faggio.



W

Quartet sauce pot wooden platter

Porta coppette quadruplo
Schale-Träger vierfach
Support à bol quadruple
Soporte copa cuatro veces

| art. | Ø cm. | dim. cm. | € |
|----------|-------|----------|-------|
| 44256-04 | 5,5 | 8x36x1,8 | 12,96 |

Beechwood. – Faggio.



MF

Bowl

Ciotola
Schale
Bol
Bol

| art. | Ø cm. | h. cm. | lt. | € |
|----------|-------|--------|------|------|
| 44846B05 | 5,5 | 4 | 0,02 | 1,51 |



MF

Bowl

Ciotola
Schale
Bol
Bol

| art. | dim. cm. | lt. | € |
|----------|-----------|------|------|
| 44466-11 | 7,5x7x4,5 | 0,05 | 3,52 |



MF

Bowl

Ciotola
Schale
Bol
Bol

| art. | dim. cm. | lt. | € |
|----------|------------|------|------|
| 44466-12 | 11,5x7,5x3 | 0,06 | 3,52 |



MF

Bowl

Ciotola
Schale
Bol
Bol

| art. | dim. cm. | lt. | € |
|----------|------------|------|------|
| 44466-13 | 11,5x6x5,5 | 0,04 | 3,52 |



MF

Bowl

Ciotola
Schale
Bol
Bol

| art. | dim. cm. | lt. | € |
|----------|----------|------|------|
| 44466-14 | 8,5x7x6 | 0,07 | 3,52 |



MF

Bowl

Ciotola
Schale
Bol
Bol

| art. | dim. cm. | lt. | € |
|----------|----------|-----|------|
| 44466-15 | 8x8x4 | 0,1 | 3,52 |

NATURAL ELEGANT



A valid alternative to glass. Elegant and unbreakable ideals for HORECA pastry and ice cream sector. Made with high quality material that confers beside resistance also glossiness and perfect transparency. Bisphenol free. Thermal tolerance -18°C +70°C. Dishwasher safe: up to 50 washes. Can be reused several times and once disposed, they are 100% recyclable. Made in Italy.

La valida alternativa al vetro. Eleganti ed infrangibili ideali per il settore HORECA della pasticceria e gelateria. Realizzati con materiale di alta qualità che gli conferisce oltre alla resistenza anche lucidità e trasparenza. Privi di Bisfenolo. Tolleranza termica -18°C +70°C. Lavabili in lavastoviglie: fino a 50 lavaggi. Possono essere riutilizzati più volte e, una volta gettati, sono riciclabili al 100%. Prodotti made in Italy.



Tasting glass

Bicchierino degustazione
Verkostung Glas
Verrine dégustation
Vaso degustación

| art. | dim. cm. | h. cm. | ml. | € |
|----------|----------|--------|-----|-------|
| 48368-05 | 6,4x4,6 | 5,3 | 50 | 21,61 |
| 48368-12 | 8,5x6 | 7,0 | 120 | 27,54 |
| 48368-20 | 10x7 | 8,3 | 200 | 35,28 |

Set 100 pcs. – Conf. 100 pz.



Tasting glass

Bicchierino degustazione
Verkostung Glas
Verrine dégustation
Vaso degustación

| art. | dim. cm. | h. cm. | ml. | € |
|----------|----------|--------|-----|-------|
| 48369-08 | 6,3x6,9 | 5,7 | 85 | 23,32 |
| 48369-14 | 7,3x8,1 | 6,7 | 140 | 25,73 |
| 48369-20 | 9x8,3 | 7,4 | 200 | 30,25 |

Set 100 pcs. – Conf. 100 pz.



Tasting dish

Piattino degustazione
Verkostung Teller
Assiette dégustation
Platillo degustación

| art. | dim. cm. | h. cm. | € |
|----------|----------|--------|-------|
| 48372-08 | 8,5x9,6 | 2 | 31,86 |

Set 100 pcs. – Conf. 100 pz.



Tasting bowl

Ciotolina degustazione
Verkostung Schale
Bol dégustation
Bol degustación

| art. | dim. cm. | h. cm. | ml. | € |
|----------|----------|--------|-----|-------|
| 48359-01 | 6,5x6,5 | 1,5 | 15 | 28,24 |

Set 100 pcs. – Conf. 100 pz.



Tasting glass

Bicchierino degustazione
Verkostung Glas
Verrine dégustation
Vaso degustación

| art. | Ø cm. | h. cm. | ml. | € |
|----------|-------|--------|-----|-------|
| 48354-01 | 4 | 8,5 | 80 | 43,11 |

Set 100 pcs. – Conf. 100 pz.



Tasting bowl

Ciotolina degustazione
Verkostung Schale
Bol dégustation
Bol degustación

| art. | dim. cm. | h. cm. | ml. | € |
|----------|----------|--------|-----|-------|
| 48357-01 | 7,5x7,5 | 3 | 50 | 28,24 |

Set 100 pcs. – Conf. 100 pz.



Tasting glass

Bicchierino degustazione
Verkostung Glas
Verrine dégustation
Vaso degustación

| art. | dim. cm. | h. cm. | ml. | € |
|----------|----------|--------|-----|-------|
| 48353-01 | 8,1x8,3 | 6,5 | 175 | 34,97 |

Set 100 pcs. – Conf. 100 pz.



Tasting dish

Piattino degustazione
Verkostung Teller
Assiette dégustation
Platillo degustación

| art. | dim. cm. | h. cm. | ml. | € |
|----------|----------|--------|-----|-------|
| 48355-01 | 8,5x8,5 | 1,5 | 20 | 28,24 |

Set 100 pcs. – Conf. 100 pz.



Tasting bowl

Ciotolina degustazione
Verkostung Schale
Bol dégustation
Bol degustación

| art. | dim. cm. | h. cm. | ml. | € |
|----------|----------|--------|-----|-------|
| 48358-01 | 10,5x5 | 3 | 11 | 28,24 |

Set 100 pcs. – Conf. 100 pz.



Tasting bowl

Ciotolina degustazione
Verkostung Schale
Bol dégustation
Bol degustación

| art. | dim. cm. | h. cm. | ml. | € |
|----------|----------|--------|-----|-------|
| 48356-01 | 8,5x8,5 | 3 | 30 | 28,24 |

Set 100 pcs. – Conf. 100 pz.

FINGER FOOD - GLASS



Set 12 Mini Glasses

Conf. 12 bicchierini
Satz 12 Stk Snack-/Dessertgläsern
Set 12 mini verres
Juego 12 vasitos

| art. | Ø cm. | h. cm. | ml. | € |
|----------|-------|--------|-----|-------|
| 41204-01 | 5 | 5,5 | 100 | 20,20 |



Set 12 Mini Glasses

Conf. 12 bicchierini
Satz 12 Stk Snack-/Dessertgläsern
Set 12 mini verres
Juego 12 vasitos

| art. | Ø cm. | h. cm. | ml. | € |
|----------|-------|--------|-----|-------|
| 41204-02 | 3,5 | 9 | 76 | 20,10 |



Set 12 Mini Glasses

Conf. 12 bicchierini
Satz 12 Stk Snack-/Dessertgläsern
Set 12 mini verres
Juego 12 vasitos

| art. | Ø cm. | h. cm. | ml. | € |
|----------|-------|--------|-----|-------|
| 41204-03 | 6,5 | 5 | 110 | 20,10 |



Set 12 Mini Glasses

Conf. 12 bicchierini
Satz 12 Stk Snack-/Dessertgläsern
Set 12 mini verres
Juego 12 vasitos

| art. | Ø cm. | h. cm. | ml. | € |
|----------|-------|--------|-----|-------|
| 41204-04 | 7 | 5 | 100 | 19,40 |



Set 12 Mini Glasses

Conf. 12 bicchierini
Satz 12 Stk Snack-/Dessertgläsern
Set 12 mini verres
Juego 12 vasitos

| art. | Ø cm. | h. cm. | ml. | € |
|----------|-------|--------|-----|-------|
| 41204-05 | 3,8 | 8 | 110 | 20,10 |



Set 12 Mini Glasses

Conf. 12 bicchierini
Satz 12 Stk Snack-/Dessertgläsern
Set 12 mini verres
Juego 12 vasitos

| art. | Ø cm. | h. cm. | ml. | € |
|----------|---------|--------|-----|-------|
| 41204-06 | 4,5x3,5 | 8,5 | 65 | 20,10 |



Set 12 Mini Glasses

Conf. 12 bicchierini
Satz 12 Stk Snack-/Dessertgläsern
Set 12 mini verres
Juego 12 vasitos

| art. | Ø cm. | h. cm. | ml. | € |
|----------|-------|--------|-----|-------|
| 41204-07 | 4,5 | 7 | 77 | 20,00 |



Set 12 Mini Glasses

Conf. 12 bicchierini
Satz 12 Stk Snack-/Dessertgläsern
Set 12 mini verres
Juego 12 vasitos

| art. | Ø cm. | h. cm. | ml. | € |
|----------|-------|--------|-----|-------|
| 41204-08 | 5 | 6,5 | 80 | 19,80 |



Set 12 Mini Glasses

Conf. 12 bicchierini
Satz 12 Stk Snack-/Dessertgläsern
Set 12 mini verres
Juego 12 vasitos

| art. | Ø cm. | h. cm. | ml. | € |
|----------|-------|--------|-----|-------|
| 41204-09 | 4,5 | 6,5 | 110 | 20,00 |



Set 12 Mini Glasses

Conf. 12 bicchierini
Satz 12 Stk Snack-/Dessertgläsern
Set 12 mini verres
Juego 12 vasitos

| art. | Ø cm. | h. cm. | ml. | € |
|----------|-------|--------|-----|-------|
| 41204-10 | 7 | 5,5 | 90 | 19,40 |



Set 12 Mini Glasses

Conf. 12 bicchierini
Satz 12 Stk Snack-/Dessertgläsern
Set 12 mini verres
Juego 12 vasitos

| art. | Ø cm. | h. cm. | ml. | € |
|----------|-------|--------|-----|-------|
| 41204-11 | 4,5 | 8,5 | 100 | 16,98 |



Set 12 Mini Glasses

Conf. 12 bicchierini
Satz 12 Stk Snack-/Dessertgläsern
Set 12 mini verres
Juego 12 vasitos

| art. | Ø cm. | h. cm. | ml. | € |
|----------|-------|--------|-----|-------|
| 41204-12 | 5,5 | 3,5 | 100 | 17,19 |



FINGER FOOD



Oval tweested dish
Ovalina goccia

| art. | dim. cm. | € |
|----------|----------|------|
| 41200-01 | 9x5x3 | 2,11 |



Eye dish
Ovalina occhio

| art. | dim. cm. | € |
|----------|-----------|------|
| 41200-02 | 8,1x5,6x3 | 2,11 |



Egg dish
Tegamino 2/m

| art. | dim. cm. | € |
|----------|-----------|------|
| 41200-03 | 8,5x6,8x2 | 2,21 |



Oval dish
Ovalina

| art. | dim. cm. | € |
|----------|------------|------|
| 41200-04 | 10x5,5x2,7 | 2,41 |



Soya sauce dish
Rettangolare

| art. | dim. cm. | € |
|----------|-----------|------|
| 41200-05 | 8x5,5x1,8 | 2,11 |



Square dish
Piatino quadro

| art. | dim. cm. | € |
|----------|----------|------|
| 41200-06 | 8x8x2,4 | 2,51 |



Oriental square dish
Quadrato orientale

| art. | dim. cm. | € |
|----------|-----------|------|
| 41200-07 | 7,5x7,5x3 | 3,02 |



Dye dish
Cubo

| art. | dim. cm. | € |
|----------|-----------|------|
| 41200-08 | 5,2x5,2x4 | 2,51 |



Chao dish
Quadrato punte

| art. | dim. cm. | € |
|----------|----------|------|
| 41200-09 | 8x8x5 | 4,32 |



Tear dish
Foglia

| art. | dim. cm. | € |
|----------|----------|------|
| 41200-10 | 8x7x3,4 | 3,02 |



Nem dish
Tronchetto

| art. | dim. cm. | € |
|----------|-------------|------|
| 41200-11 | 5,5x4,5x6,5 | 3,02 |



Rectangular w/lid
Rettangolare c/cop

| art. | dim. cm. | € |
|----------|------------|------|
| 41200-13 | 10x5,5x4,5 | 6,03 |



Square pan with lid
Quadra c/cop

| art. | dim. cm. | € |
|----------|-----------|------|
| 41200-14 | 9x3,6x4,5 | 6,03 |



Oval pan with lid
Ovale c/cop

| art. | dim. cm. | € |
|----------|------------|------|
| 41200-15 | 10,5x7x4,5 | 6,03 |



Rectangular pan
Casseruola rett.

| art. | dim. cm. | € |
|----------|------------|------|
| 41200-16 | 10x5,5x4,5 | 4,02 |



Square pan
Casseruola quadra

| art. | dim. cm. | € |
|----------|-----------|------|
| 41200-17 | 9x3,6x4,5 | 4,02 |





| Oval pan Casseruola ovale | | | |
|-------------------------------------|------------|------|--|
| art. | dim. cm. | € | |
| 41200-18 | 10,5x7x4,5 | 4,02 | |



| Footed square dish Quadrato | | | |
|---------------------------------------|-----------|------|--|
| art. | dim. cm. | € | |
| 41200-32 | 10x10x1,2 | 3,62 | |



| Fish dish Piattino pesce | | | |
|------------------------------------|------------|------|--|
| art. | dim. cm. | € | |
| 41200-33 | 10,5x5x1,6 | 2,51 | |



| Small pan Tegamino | | | |
|------------------------------|-----------|------|--|
| art. | dim. cm. | € | |
| 41200-34 | 9,7x6x2,6 | 2,41 | |



| Mini pasta bowl Mini ciotola pasta | | | |
|--|------------|------|--|
| art. | dim. cm. | € | |
| 41200-36 | 10x2,5x1,6 | 3,62 | |



| Square dish Coppetta quadra | | | |
|---------------------------------------|----------|------|--|
| art. | dim. cm. | € | |
| 41200-40 | 7x7x3,5 | 3,12 | |



| Round bowl Bolo tondo | | | |
|---------------------------------|-------|--------|------|
| art. | Ø cm. | h. cm. | € |
| 41200-41 | 7 | 4,5 | 3,02 |



| Small pot Mini pentola | | | |
|----------------------------------|----------|------|--|
| art. | dim. cm. | € | |
| 41200-49 | 5x5x5 | 4,32 | |



| Small bucket Secchiello | | | |
|-----------------------------------|----------|------|--|
| art. | dim. cm. | € | |
| 41200-50 | 6x6x4,5 | 4,62 | |



| Colander Colapasta | | | |
|------------------------------|----------|------|--|
| art. | dim. cm. | € | |
| 41200-51 | 7x7x4,5 | 5,13 | |



| Fruit case Cassetta frutta | | | |
|--------------------------------------|-----------|------|--|
| art. | dim. cm. | € | |
| 41200-52 | 8x5,5x2,3 | 5,93 | |



| Tin with lid Scatoletta c/cop | | | |
|---|------------|------|--|
| art. | dim. cm. | € | |
| 41200-53 | 13,5x5,5x5 | 7,54 | |



| Tin with lid Scatoletta c/cop | | | | |
|---|-------|--------|------|--|
| art. | Ø cm. | h. cm. | € | |
| 41200-54 | 8 | 4 | 4,42 | |



| French fries bowl Vaschetta patatine | | | |
|--|----------|------|--|
| art. | dim. cm. | € | |
| 41200-58 | 13x10x4 | 6,03 | |



| Rectangular w/handles Rettangolare c/m | | | |
|--|-----------|------|--|
| art. | dim. cm. | € | |
| 41200-59 | 14x10x3,5 | 7,24 | |



| Rectangular lid Coperchio rett. | | | |
|---|----------|------|--|
| art. | dim. cm. | € | |
| 41200-60 | 14x10 | 4,42 | |



| Oval w/handles Ovale c/m | | | |
|------------------------------------|------------|------|--|
| art. | dim. cm. | € | |
| 41200-61 | 14x9,5x3,5 | 7,64 | |



| Oval lid Coperchio ovale | | | |
|------------------------------------|----------|------|--|
| art. | dim. cm. | € | |
| 41200-62 | 14x9,5 | 4,42 | |



| Round w/handles Tonda c/m | | | |
|-------------------------------------|-------|--------|------|
| art. | Ø cm. | h. cm. | € |
| 41200-63 | 13 | 5,5 | 9,85 |



| Round lid Coperchio tondo | | | |
|-------------------------------------|-------|------|--|
| art. | Ø cm. | € | |
| 41200-64 | 13 | 4,82 | |



| Ramequin Ramequin | | | |
|-----------------------------|-------|--------|------|
| art. | Ø cm. | h. cm. | € |
| 41200-46 | 10 | 5,0 | 4,62 |
| 41200-47 | 9 | 5,0 | 3,82 |
| 41200-48 | 8 | 4,5 | 2,91 |



| Vintage tray Vassoietto vintage | | | |
|---|-----------|------|--|
| art. | dim. cm. | € | |
| 41200-55 | 15x10x1,7 | 6,03 | |



| Vintage tray Vassoietto vintage | | | |
|---|-----------|-------|--|
| art. | dim. cm. | € | |
| 41200-56 | 22,3x14x2 | 10,15 | |



| Vintage tray Vassoietto vintage | | | |
|---|-------------|-------|--|
| art. | dim. cm. | € | |
| 41200-57 | 29,5x20,5x2 | 18,99 | |

TABLE TOP TAVOLA

SERVING ITEMS
COMPLEMENTI





A practical and funny series for children but not only. Simple shapes, bright colors. The decoration in its simplicity of the circles, brings a good mood to the table. Suitable for both indoor and outdoor spaces, but also a smart choice for catering services and large numbers.

Una serie pratica e divertente per i bambini ma non solo. Forme semplici, colori sgargianti. Il decoro nella sua semplicità dei cerchi, porta buonumore a tavola. Adatta sia agli spazi indoor che outdoor, ma anche una scelta intelligente per servizi di catering e grandi numeri.



Flat plate

Piatto piano
Teller flach
Assiette plate
Plato llano

| art. | Ø cm. | € |
|----------|-------|------|
| 17621-01 | 20 | 3,62 |



Flat plate

Piatto piano
Teller flach
Assiette plate
Plato llano

| art. | Ø cm. | € |
|----------|-------|------|
| 17621-02 | 25 | 3,62 |



Soup plate

Piatto fondo
Teller tief
Assiette creuse
Plato hondo

| art. | Ø cm. | h. cm. | € |
|----------|-------|--------|------|
| 17621-09 | 17 | 4 | 3,32 |



Bowl

Ciotola
Schüssel
Bol
Cuenco

| art. | Ø cm. | h. cm. | ml. | € |
|----------|-------|--------|-----|------|
| 17621-80 | 11 | 5,5 | 260 | 3,72 |



Cup

Tazza
Tasse
Tasse
Taza

| art. | Ø cm. | h. cm. | ml. | € |
|----------|-------|--------|-----|------|
| 17621-40 | 7 | 7,5 | 180 | 4,32 |



Tumbler

Bicchiere
Becher
Gobelet
Vaso

| art. | Ø cm. | h. cm. | ml. | € |
|----------|-------|--------|-----|------|
| 17621-44 | 8,5 | 9 | 260 | 2,61 |



Spoon

Cucchiaio
Löffel
Cuillère
Cuchara

| art. | dim. cm. | € |
|----------|----------|------|
| 17621-90 | 14,5x3 | 0,80 |



Fork and spoon

Forchetta e cucchiaio
Gabel und Löffel
Fourchette et cuillère
Tenedor y cuchara

| art. | dim. cm. | € |
|----------|----------|------|
| 17621-92 | 19x3,5 | 1,61 |



TABLE MATS & RUNNERS
TOVAGLIETTE & RUNNER

Material: 50% polyester - 50% Polyvinyl chloride

Materiale: 50% Poliestere - 50% Cloruro di polivinile



Table mat - Light melange
Tovaglietta - Melange chiaro

| art. | dim. cm. | pcs/pz | € |
|----------|----------|--------|-------|
| 42950-01 | 42x33 | 6 | 22,51 |



Table mat - Brown
Tovaglietta - Marrone

| art. | dim. cm. | pcs/pz | € |
|----------|----------|--------|-------|
| 42950-04 | 42x33 | 6 | 22,51 |



Table mat - Sandy
Tovaglietta - Beige

| art. | dim. cm. | pcs/pz | € |
|----------|----------|--------|-------|
| 42950-02 | 42x33 | 6 | 22,51 |

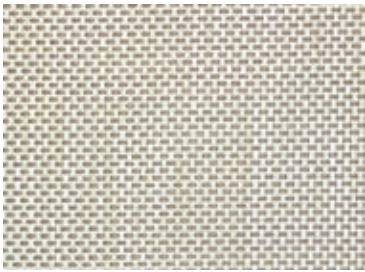

Table mat - Beige-Grey
Tovaglietta - Beige-Grigio

| art. | dim. cm. | pcs/pz | € |
|----------|----------|--------|-------|
| 42950-05 | 42x33 | 6 | 22,51 |



Table mat - Coral
Tovaglietta - Corallo

| art. | dim. cm. | pcs/pz | € |
|----------|----------|--------|-------|
| 42950-08 | 42x33 | 6 | 22,51 |

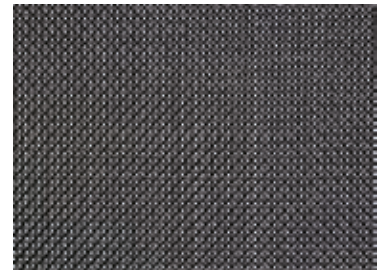

Table mat - Black
Tovaglietta - Nero

| art. | dim. cm. | pcs/pz | € |
|----------|----------|--------|-------|
| 42950-03 | 42x33 | 6 | 22,51 |

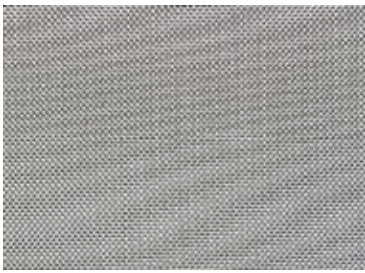

Table mat - Grey
Tovaglietta - Grigio

| art. | dim. cm. | pcs/pz | € |
|----------|----------|--------|-------|
| 42950-06 | 42x33 | 6 | 22,51 |

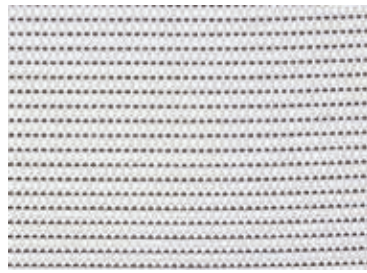

Table mat - White pin-striped
Tovaglietta - Gessato bianco

| art. | dim. cm. | pcs/pz | € |
|----------|----------|--------|-------|
| 42950-09 | 42x33 | 6 | 22,51 |



RUNNER - Sandy
Beige

| art. | dim. cm. | € |
|----------|----------|-------|
| 42950-92 | 42x180 | 21,31 |

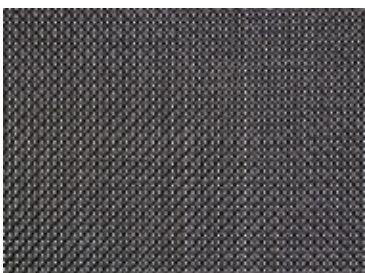

RUNNER - Black
Nero

| art. | dim. cm. | € |
|----------|----------|-------|
| 42950-93 | 42x180 | 21,31 |



RUNNER - Brown
Marrone

| art. | dim. cm. | € |
|----------|----------|-------|
| 42950-94 | 42x180 | 21,31 |



NATURAL SLATE
 ARDESIA NATURALE

Excellent coldness retention, food safe. The edges of the trays are broken to show the typical structure of the natural material. With anti-slip feet. No dishwasher proof. Material thickness: 6-9 mm.

Eccellente immagazzinamento del freddo, idonei al contatto alimentare. Gli angoli dei piani sono spezzati per evidenziare la tipica struttura del materiale. Con piedini antiscivolo. Non idonei al lavaggio in lavastoviglie. Spessore: 6-9 mm.



Tray
 Vassoio
 Platte
 Plateau
 Placa

| art. | dim. cm. | € |
|----------|----------|------|
| 41585-37 | 20x10 | 5,13 |



Tray
 Plancia
 Platte
 Plateau
 Placa

| art. | GN | dim. cm. | € |
|----------|-----|-----------|-------|
| 41585-11 | 1/1 | 53x32,2 | 27,54 |
| 41585-12 | 1/2 | 32,5x26,5 | 14,77 |
| 41585-13 | 1/3 | 32,5x17,5 | 9,25 |
| 41585-24 | 1/4 | 26,5x16,5 | 8,34 |
| 41585-23 | 2/4 | 53x16,2 | 11,16 |



Square tray
 Plancia quadra
 Platte, viereckig
 Plateau carré
 Placa cuadrada

| art. | dim. cm. | € |
|----------|----------|-------|
| 41585-25 | 25x25 | 11,06 |
| 41585-30 | 30x30 | 16,48 |



Rectangular tray

Plancia rettangolare
Platte, rechteckig
Plateau rectangulaire
Placa rectangular

| art. | dim. cm. | € |
|----------|----------|-------|
| 41585-45 | 45x30 | 22,01 |



Round tray

Plancia tonda
Platte, rund
Plateau ronde
Placa redonda

| art. | Ø cm. | € |
|----------|-------|-------|
| 41586-22 | 22 | 8,74 |
| 41586-28 | 28 | 12,46 |
| 41586-33 | 33 | 14,67 |
| 41586-38 | 38 | 22,01 |



Square tray, 4 pcs set

Plancia quadra, set 4 pz
Platte, viereckig, Satz 4 Stk
Plateau carré, set 4 pcs
Placa cuadrada, juego 4 pz

| art. | dim. cm. | € |
|----------|----------|-------|
| 41585-10 | 10x10 | 14,57 |



Tray with holes

Vassoio con fori
Platte mit Absätze
Plat avec trous
Placa con agujeros

| art. | Ø cm. | dim. cm. | € |
|----------|-------|----------|------|
| 41585-01 | 6 | 25x12 | 7,04 |



Tray with holes

Vassoio con fori
Platte mit Absätze
Plat avec trous
Placa con agujeros

| art. | Ø cm. | dim. cm. | € |
|----------|-------|----------|------|
| 41585-02 | 6 | 15x8 | 5,53 |



Tray with holes

Vassoio con fori
Platte mit Absätze
Plat avec trous
Placa con agujeros

| art. | Ø cm. | dim. cm. | € |
|----------|-------|----------|------|
| 41585-03 | 6 | 28x10 | 9,85 |



Tray with dome

Platto con campana
Platte mit Glashaube
Plat avec cloche
Bandeja y campana

| art. | Ø cm. | h. cm. | € |
|----------|-------|--------|-------|
| 41585-00 | 10,5 | 8 | 14,17 |



Tray 2-tier

Alzata 2 piani
Etagère 2-stufig
Présentoir 2 niveaux
Bandeja 2 niveles

| art. | Ø cm. | h. cm. | € |
|----------|-------|--------|-------|
| 41587-25 | 20-25 | 24 | 26,03 |



Tray 3-tier

Alzata 3 piani
Etagère 3-stufig
Présentoir 3 niveaux
Bandeja 3 niveles

| art. | Ø cm. | h. cm. | € |
|----------|----------|--------|-------|
| 41587-03 | 20-25-30 | 34 | 46,93 |

NEW



Revolving platter

Supporto girevole
Servierplatt, drehbar
Présentoir tournant
Soporte rotatorio

| art. | Ø cm. | h. cm. | € |
|----------|-------|--------|-------|
| 41587-32 | 32 | 2,5 | 31,05 |



Tray

Plancia
Platte
Plateau
Placa

| art. | dim. cm. | fits/per | € |
|----------|-----------|----------|-------|
| 41585-51 | 24x15 | 44842-30 | 7,04 |
| 41585-52 | 47x10 | 44843-24 | 10,85 |
| 41585-53 | 26,5x20,5 | 44843-12 | 10,85 |
| 41585-54 | 32x12 | 44842-35 | 7,34 |



Acacia wood.

BLACK & BROWN
 NERO & MARRONE

The rough surface structure creates a natural appearance. The black bowls and trays with brown border stage your dishes in a very stylish way.

La struttura superficiale ruvida crea un aspetto naturale. Le ciotole e i vassoi neri con bordo marrone mettono in scena le pietanze in modo molto elegante.



Bowl
Ciotola
Schüssel
Bol
Bol

| art. | Ø cm. | h. cm. | lt. | € |
|----------|-------|--------|-----|-------|
| 44480-10 | 14 | 6,0 | 0,3 | 13,17 |
| 44480-11 | 19 | 8,0 | 0,8 | 23,62 |
| 44480-12 | 21 | 8,5 | 1,0 | 24,42 |



Bowl
Ciotola
Schüssel
Bol
Bol

| art. | Ø cm. | h. cm. | lt. | € |
|----------|-------|--------|------|-------|
| 44480-15 | 11 | 3,5 | 0,13 | 10,95 |
| 44480-16 | 14 | 4,0 | 0,20 | 12,16 |
| 44480-20 | 30,5 | 8,5 | 2,00 | 41,71 |



Tray
Vassoio
Tablett
Plateau
Bandeja

| art. | dim. cm. | € |
|----------|-------------|-------|
| 44480-03 | 14,5x14,5x2 | 10,95 |



Tray
Vassoio
Tablett
Plateau
Bandeja

| art. | dim. cm. | € |
|----------|-------------|-------|
| 44480-06 | 26,5x16,5x4 | 23,32 |



Bowl
Ciotola
Schüssel
Bol
Bol

| art. | Ø cm. | h. cm. | lt. | € |
|----------|-------|--------|------|-------|
| 44480-07 | 8,5 | 2,5 | 0,05 | 10,95 |



Bowl
Ciotola
Schüssel
Bol
Bol

| art. | Ø cm. | h. cm. | lt. | € |
|----------|-------|--------|------|-------|
| 44480-08 | 11,5 | 3 | 0,04 | 11,66 |



Bowl
Ciotola
Schüssel
Bol
Bol

| art. | Ø cm. | h. cm. | lt. | € |
|----------|-------|--------|-----|-------|
| 44480-09 | 11 | 5,5 | 0,2 | 11,26 |



Tray
Vassoio
Tablett
Plateau
Bandeja

| art. | dim. cm. | € |
|----------|---------------|-------|
| 44480-19 | 32,5x23,5x4,5 | 33,37 |



Bowl
Ciotola
Schüssel
Bol
Bol

| art. | dim. cm. | lt. | € |
|----------|-------------|-----|-------|
| 44480-00 | 25,5x14x5,5 | 0,4 | 16,58 |
| 44480-01 | 36x19x8 | 0,9 | 25,33 |



Tray
Vassoio
Tablett
Plateau
Bandeja

| art. | dim. cm. | € |
|----------|-----------|-------|
| 44480-04 | 22,5x15x3 | 20,20 |
| 44480-05 | 27,5x11x2 | 20,20 |



Tray
Vassoio
Tablett
Plateau
Bandeja

| art. | dim. cm. | € |
|----------|------------|-------|
| 44480-17 | 19,5x9,5x2 | 16,88 |
| 44480-18 | 39x16x3 | 33,37 |



CLAY
ARGILLA



Serving and buffet items, an imitation of clay, either white with brown border or dark brown with terracotta border. The surface is inside and outside fine-matt. Feels like real clay.

Piatti da servizio e buffet, un'imitazione dell'argilla, sia bianchi con bordo marrone o moro con bordo terracotta. La superficie interna ed esterna è finemente opaca. Effetto argilla anche al tatto.



Soup plate
Piatto fondo
Teller tief
Assiette creuse
Plato hondo

| art. | Ø cm. | h. cm. | lt. | col. | € |
|----------|-------|--------|-----|------|-------|
| 44478-20 | 20,5 | 3 | 0,5 | ● | 12,46 |



Soup plate
Piatto fondo
Teller tief
Assiette creuse
Plato hondo

| art. | Ø cm. | h. cm. | lt. | col. | € |
|----------|-------|--------|-----|------|-------|
| 44478-21 | 20,5 | 3 | 0,5 | ● | 12,46 |



Flat plate
Piatto piano
Teller flach
Assiette plate
Plato llano

| art. | dim. cm. | col. | € |
|----------|-----------|------|------|
| 44478-22 | 14x13x2,5 | ● | 6,63 |

TABLE TOP TAVOLA
SERVING ITEMS COMPLEMENTI



Flat plate
Piatto piano
Teller flach
Assiette plate
Plato llano

| art. | dim. cm. | col. | € |
|----------|-----------|------|------|
| 44478-23 | 14x13x2,5 | ● | 6,63 |



Bowl
Ciotola
Schüssel
Bol

| art. | Ø cm. | h. cm. | lt. | col. | € |
|----------|-------|--------|------|------|-------|
| 44478-24 | 12,5 | 6 | 0,37 | ● | 7,04 |
| 44478-26 | 16 | 7 | 0,70 | ● | 11,86 |



Bowl
Ciotola
Schüssel
Bol

| art. | Ø cm. | h. cm. | lt. | col. | € |
|----------|-------|--------|------|------|-------|
| 44478-25 | 12,5 | 6 | 0,37 | ● | 7,04 |
| 44478-27 | 16 | 7 | 0,70 | ● | 11,96 |



Bowl
Ciotola
Schüssel
Bol

| art. | Ø cm. | h. cm. | lt. | col. | € |
|----------|-------|--------|-----|------|-------|
| 44478-28 | 16,5 | 4 | 0,5 | ● | 11,46 |



Bowl
Ciotola
Schüssel
Bol

| art. | Ø cm. | h. cm. | lt. | col. | € |
|----------|-------|--------|-----|------|-------|
| 44478-29 | 16,5 | 4 | 0,5 | ● | 11,46 |



Bowl
Ciotola
Schüssel
Bol

| art. | Ø cm. | h. cm. | lt. | col. | € |
|----------|-------|--------|------|------|-------|
| 44478-30 | 21 | 8 | 1,45 | ● | 20,20 |



Bowl
Ciotola
Schüssel
Bol

| art. | Ø cm. | h. cm. | lt. | col. | € |
|----------|-------|--------|------|------|-------|
| 44478-31 | 21 | 8 | 1,45 | ● | 20,20 |



Bowl
Ciotola
Schüssel
Bol

| art. | dim. cm. | lt. | col. | € |
|----------|-------------|------|------|-------|
| 44478-32 | 30,5x10x7,5 | 0,17 | ● | 13,37 |
| 44478-34 | 42x14x9,5 | 0,65 | ● | 31,05 |



Bowl
Ciotola
Schüssel
Bol

| art. | dim. cm. | lt. | col. | € |
|----------|-------------|------|------|-------|
| 44478-33 | 30,5x10x7,5 | 0,17 | ● | 13,37 |
| 44478-35 | 42x14x9,5 | 0,65 | ● | 31,05 |



GLASS JARS
VASETTI WECK



Perfect for the sterilization and pasteurization of any product, fruit, vegetables, but also meat, fish, foie gras or delicatessen products. They are suitable for serving jams and sauces: they also look beautiful on the table. They are perfect for cooking and serving on the table. They are 100% pure glass, so they do not release harmful substances into food, they resist very high temperatures (up to 200°C in the oven), they can be washed in the dishwasher (including seal).

Perfetti per la sterilizzazione e la pastorizzazione di qualsiasi prodotto, di frutta verdura ma anche di carne, pesce, foie gras o prodotti di salumeria. Sono indicati per servire marmellate e salse di accompagnamento: inoltre belli da vedere sulla tavola. Sono i vasetti perfetti per la vasocottura e per servire in tavola. Sono al 100% in puro vetro, quindi non rilasciano sostanze nocive nel cibo, resistono a temperature elevatissime (fino a 200°C in forno), si possono lavare in lavastoviglie (guarnizione compresa).



Glasses with cover, 12 pcs
Vasetti con coperchio, 12 pz
Gläser mit Deckel, 12er Set
Verres avec couvercle, 12 pcs
Vasos con tapa, 12 pz

| art. | Ø cm. | h. cm. | ml. | € |
|----------|-------|--------|-----|-------|
| 41589-08 | 6 | 5,5 | 80 | 36,68 |
| 41589-14 | 6 | 7,0 | 140 | 40,50 |



Glasses with cover, 12 pcs
Vasetti con coperchio, 12 pz
Gläser mit Deckel, 12er Set
Verres avec couvercle, 12 pcs
Vasos con tapa, 12 pz

| art. | Ø cm. | h. cm. | ml. | € |
|----------|-------|--------|-----|-------|
| 41589-16 | 6 | 8 | 160 | 40,50 |



Glasses with cover, 12 pcs
Vasetti con coperchio, 12 pz
Gläser mit Deckel, 12er Set
Verres avec couvercle, 12 pcs
Vasos con tapa, 12 pz

| art. | Ø cm. | h. cm. | ml. | € |
|----------|-------|--------|-----|---|
| 41589-20 | 9 | 6 | 200 | - |



Glasses with cover, 12 pcs
Vasetti con coperchio, 12 pz
Gläser mit Deckel, 12er Set
Verres avec couvercle, 12 pcs
Vasos con tapa, 12 pz

| art. | Ø cm. | h. cm. | ml. | € |
|----------|-------|--------|-----|-------|
| 41589-22 | 7 | 8 | 220 | 40,50 |



Glasses with cover, 12 pcs
Vasetti con coperchio, 12 pz
Gläser mit Deckel, 12er Set
Verres avec couvercle, 12 pcs
Vasos con tapa, 12 pz

| art. | Ø cm. | h. cm. | ml. | € |
|----------|-------|--------|-----|-------|
| 41589-07 | 5,5 | 6 | 75 | 33,47 |



Glasses with cover, 6 pcs
Vasetti con coperchio, 6 pz
Gläser mit Deckel, 6er Set
Verres avec couvercle, 6 pcs
Vasos con tapa, 6 pz

| art. | Ø cm. | h. cm. | ml. | € |
|----------|-------|--------|-----|-------|
| 41589-29 | 9 | 9 | 290 | 22,21 |



Glasses with cover, 6 pcs
Vasetti con coperchio, 6 pz
Gläser mit Deckel, 6er Set
Verres avec couvercle, 6 pcs
Vasos con tapa, 6 pz

| art. | Ø cm. | h. cm. | ml. | € |
|----------|-------|--------|-----|-------|
| 41589-59 | 11 | 9 | 580 | 26,03 |



Glasses with cover, 2 pcs
Vasetti con coperchio, 2 pz
Gläser mit Deckel, 2er Set
Verres avec couvercle, 2 pcs
Vasos con tapa, 2 pz

| art. | Ø cm. | h. cm. | ml. | € |
|----------|-------|--------|-----|-------|
| 41589-58 | 11 | 11 | 580 | 11,16 |



Glasses with cover, 3 pcs
Vasetti con coperchio, 3 pz
Gläser mit Deckel, 3er Set
Verres avec couvercle, 3 pcs
Vasos con tapa, 3 pz

| art. | Ø cm. | h. cm. | ml. | € |
|----------|-------|--------|-----|-------|
| 41589-37 | 11 | 7,5 | 370 | 12,36 |



Glasses with cover, 2 pcs
Vasetti con coperchio, 2 pz
Gläser mit Deckel, 2er Set
Verres avec couvercle, 2 pcs
Vasos con tapa, 2 pz

| art. | Ø cm. | h. cm. | ml. | € |
|----------|-------|--------|-----|---|
| 41589-30 | 11 | 7,5 | 370 | - |



Glasses with cover, 2 pcs
Vasetti con coperchio, 2 pz
Gläser mit Deckel, 2er Set
Verres avec couvercle, 2 pcs
Vasos con tapa, 2 pz

| art. | Ø cm. | h. cm. | ml. | € |
|----------|-------|--------|-----|-------|
| 41589-31 | 11 | 11 | 580 | 32,76 |

S/steel covers. – Coperchi inox.

S/steel covers. – Coperchi inox.



Glasses with cover, 2 pcs
Vasetti con coperchio, 2 pz
Gläser mit Deckel, 2er Set
Verres avec couvercle, 2 pcs
Vasos con tapa, 2 pz

| art. | Ø cm. | h. cm. | ml. | € |
|----------|-------|--------|-----|---|
| 41589-34 | 11 | 7,5 | 370 | - |

Beech covers. – Coperchi faggio.



Glasses with cover, 2 pcs
Vasetti con coperchio, 2 pz
Gläser mit Deckel, 2er Set
Verres avec couvercle, 2 pcs
Vasos con tapa, 2 pz

| art. | Ø cm. | h. cm. | ml. | € |
|----------|-------|--------|-----|---|
| 41589-35 | 11 | 11 | 580 | - |

Beech covers. – Coperchi faggio.



Bottles with cover, 6 pcs
Bottigliette con coperchio, 6 pz
Flaschen mit Deckel, 6er Set
Bouteilles avec couvercle, 6 pcs
Botellas con tapa, 6 pz

| art. | Ø cm. | h. cm. | ml. | € |
|----------|-------|--------|-----|-------|
| 41589-25 | 6,5 | 14,5 | 250 | 22,21 |



Bottles with cover, 6 pcs

Bottigliette con coperchio, 6 pz
Flaschen mit Deckel, 6er Set
Bouteilles avec couvercle, 6 pcs
Botellas con tapa, 6 pz

| art. | Ø cm. | h. cm. | ml. | € |
|----------|-------|--------|-----|-------|
| 41589-50 | 6,5 | 19 | 500 | 25,02 |



Bottles with cover, 6 pcs

Bottigliette con coperchio, 6 pz
Flaschen mit Deckel, 6er Set
Bouteilles avec couvercle, 6 pcs
Botellas con tapa, 6 pz

| art. | Ø cm. | h. cm. | ml. | € |
|----------|-------|--------|------|-------|
| 41589-99 | 6,5 | 25,5 | 1000 | 29,35 |



NEW

Covers, 12 pcs

Coperchi, 12 pz
Deckel, 12er Set
Couvercle, 12 pcs
Tapa, 12 pz

| art. | Ø cm. | fits/per | € |
|----------|-------|-------------------------|-------|
| 41589-00 | 7 | 25/50/99/08 14/16/22 | 48,44 |



NEW

Cover

Coperchio
Deckel
Couvercle
Tapa

| art. | Ø cm. | fits/per | € |
|----------|-------|----------|------|
| 41589-01 | 11 | 37/58 | 7,94 |

Beech, silicone seal.
Faggio, guarnizione silicone.



NEW

Cover

Coperchio
Deckel
Couvercle
Tapa

| art. | Ø cm. | fits/per | € |
|----------|-------|----------|------|
| 41589-02 | 10,5 | 37/58 | 9,65 |

Stainless steel, silicone seal.
Inox, guarnizione silicone.



Rubber rings, 10 pcs

Guarnizioni, 10 pz
Gummidichtringe, 10er Set
Joints, 10 pièces
Juntas, 10 piezas

| art. | Ø cm. | fits/per | € |
|----------|-------|----------|------|
| 41589-AA | 6 | 08/14/16 | 2,21 |
| 41589-BB | 9 | 20/29 | 2,31 |
| 41589-CC | 11 | 37/58/59 | 2,31 |



Airtight covers, 5 pcs

Coperchi ermetici, 5 pz
Frischhaltedeckel, 5er Set
Couvercles hermétiques, 5 pcs
Tapas herméticas, 5 pz

| art. | fits/per | € |
|----------|----------------------|------|
| 41589-AC | 08/14/16 25/50/99 | 4,12 |



SS

Cover clamps, 8 pcs

Clip, 8 pezzi
Deckel-Klammer, 8er Set
Clips crochets, 8 pcs
Abrazaderas, 8 pz

| art. | € |
|----------|------|
| 41589-AB | 4,22 |



Glasses (without lid), 12 pcs

Vasetti (senza coperchi), 12 pz
Gläser (ohne Deckel), 12er Set
Verres (sans couvercle), 12 pcs
Vasos (sin tapa), 12 pz

| art. | Ø cm. | h. cm. | ml. | - | € |
|----------|-------|--------|-----|-----|-------|
| 41589-04 | 5 | 3,5 | 35 | NEW | 16,78 |
| 41589C08 | 6 | 5,5 | 80 | - | 21,61 |
| 41589C16 | 6 | 8,0 | 160 | - | 23,22 |



SS

Insulated beverage server

Caraffa termica
Thermokanne
Pot isotherme
Jarra térmica

| art. | lt. | € |
|----------|-----|-------|
| 41650-06 | 0,6 | 58,69 |
| 41650-10 | 1,0 | 65,73 |
| 41650-13 | 1,5 | 72,66 |



SS

Insulated beverage server

Caraffa termica
Thermokanne
Pot isotherme
Jarra térmica

| art. | lt. | € |
|----------|------|--------|
| 41646-06 | 0,75 | 74,27 |
| 41646-10 | 1,00 | 77,69 |
| 41646-15 | 1,50 | 90,25 |
| 41646-20 | 2,00 | 125,52 |



SS

Insulated beverage server

Caraffa termica
Thermokanne
Pot isotherme
Jarra térmica

| art. | lt. | € |
|----------|-----|-------|
| 42401-10 | 1,0 | 26,43 |
| 42401-15 | 1,5 | 29,25 |
| 42401-20 | 2,0 | 31,36 |



SS

Insulated beverage server

Caraffa termica
Thermokanne
Pot isotherme
Jarra térmica

| art. | lt. | € |
|----------|-----|-------|
| 42405-10 | 1 | 24,62 |
| 42405-20 | 2 | 30,65 |



SS

PP

Insulated beverage server

Caraffa termica
Thermokanne
Pot isotherme
Jarra térmica

| art. | Ø cm. | h. cm. | lt. | € |
|----------|-------|--------|-----|-------|
| 42403-01 | 16 | 20 | 1 | 28,34 |

8 cups. – 8 tazze.



SS

PP

Insulated beverage server

Caraffa termica
Thermokanne
Pot isotherme
Jarra térmica

| art. | Ø cm. | h. cm. | lt. | € |
|----------|-------|--------|-----|-------|
| 42403B01 | 16 | 20 | 1 | 28,34 |

8 cups. – 8 tazze.



SS

French press

Caffettiera pressa filtro
Kaffeebereiter
Cafetière à piston
Jarra para infusiones

| art. | ml. | col. | € |
|----------|-----|------|-------|
| 42407-03 | 350 | ● | 15,88 |
| 42407-06 | 600 | ● | 19,90 |



SS

French press

Caffettiera pressa filtro
Kaffeebereiter
Cafetière à piston
Jarra para infusiones

| art. | ml. | € |
|----------|-----|-------|
| 42408-03 | 350 | 12,66 |
| 42408-06 | 600 | 15,58 |
| 42408-08 | 800 | 18,59 |



PC

Water jug

Caraffa
Wasserkrug
Crûche à eau
Jarra agua

| art. | Ø cm. | h. cm. | lt. | € |
|----------|-------|--------|-----|-------|
| 44999-09 | 10 | 15 | 0,9 | 9,55 |
| 44999-16 | 12 | 20 | 1,6 | 16,48 |



SMMA



Water jug

Caraffa
Wasserkrug
Crûche à eau
Jarra agua

| art. | Ø cm. | h. cm. | lt. | € |
|----------|-------|--------|-----|-------|
| 44992-03 | 26 | 29 | 3 | 27,14 |



Water jug
Caraffa
Wasserkrug
Crûche à eau
Jarra agua

| art. | Ø cm. | h. cm. | lt. | € |
|----------|-------|--------|-----|-------|
| 44994-00 | 14 | 29 | 2,5 | 23,52 |



Water jug
Caraffa
Wasserkrug
Crûche à eau
Jarra agua

| art. | Ø cm. | h. cm. | lt. | € |
|----------|-------|--------|-----|-------|
| 44992-02 | 16,5 | 26 | 2 | 21,21 |



Water jug
Caraffa
Wasserkrug
Crûche à eau
Jarra agua

| art. | dim. cm. | lt. | € |
|----------|-----------|-----|-------|
| 44871-28 | 12x13,8 | 0,5 | 9,95 |
| 44871-30 | 17,4x17 | 1,0 | 13,27 |
| 44871-32 | 18,7x19,8 | 1,5 | 16,88 |
| 44871-34 | 21,6x18,8 | 2,0 | 21,11 |

Withstands temperatures/Termoresistenti da:
-30° +120°C.



Lid
Coperchio
Deckel
Couverture
Tapa

| art. | dim. cm. | fits/per | U. Pack | € |
|----------|----------|----------|---------|------|
| 44871-29 | 9,9x1,4 | l. 0,5 | 10 | 2,81 |
| 44871-31 | 11,2x1,9 | l. 1,0 | 10 | 4,52 |
| 44871-33 | 14x2,4 | l. 1,5 | 10 | 4,62 |
| 44871-35 | 15,9x2,2 | l. 2,0 | 10 | 4,62 |

Withstands temperatures/Termoresistenti da:
-40° +100°C.



Juice pitcher, glass
Caraffa vetro
Glaskaraffe
Carafe à jus, verre
Jarra zumo, vidrio

| art. | Ø cm. | h. cm. | lt. | € |
|----------|-------|--------|-----|-------|
| 44995-15 | 9,5 | 27 | 1,5 | 42,21 |

Stainless steel lid. – Coperchio inox.



Juice pitcher, glass
Caraffa vetro
Glaskaraffe
Carafe à jus, verre
Jarra zumo, vidrio

| art. | Ø cm. | h. cm. | lt. | € |
|----------|-------|--------|-----|-------|
| 44992-15 | 10 | 26 | 1,5 | 32,66 |

Stainless steel lid with integrated strainer for cores or ice. – Coperchio inox con filtro integrato per semi o ghiaccio.



Juice pitcher, glass
Caraffa vetro
Glaskaraffe
Carafe à jus, verre
Jarra zumo, vidrio

| art. | Ø cm. | h. cm. | lt. | € |
|----------|-------|--------|-----|-------|
| 44995-14 | 16 | 27 | 1,4 | 60,80 |

Spout opens and closes automatically. Chromed foot with cooler, keep drinks chilled up to 4 hours. – Tappo apre e chiude automaticamente. Piede cromato con eutettico, mantiene le bevande refrigerate fino a 4 ore.



Juice pitcher, glass

Caraffa vetro
Glaskaraffe
Carafe à jus, verre
Jarra zumo, vidrio

| art. | Ø cm. | h. cm. | lt. | € |
|----------|-------|--------|-----|-------|
| 44995-10 | 9,5 | 29 | 1 | 38,79 |

Spout opens and closes automatically while serving. – Tappo versatore apre e chiude automaticamente.



PC

PP

Juice pitcher with lid

Caraffa con coperchio
Saftkanne mit Deckel
Carafe à jus avec couvercle
Jarra zumo con tapa

| art. | Ø cm. | h. cm. | lt. | € |
|----------|-------|--------|-----|-------|
| 44993-01 | 11 | 30 | 1,6 | 26,93 |

Screwed lid, aroma-tight.

Coperchio avvitato, a tenuta di aroma.



NEW

Juice pitcher, glass

Caraffa vetro
Glaskaraffe
Carafe à jus, verre
Jarra zumo, vidrio

| art. | Ø cm. | h. cm. | lt. | € |
|----------|-------|--------|-----|-------|
| 44992-10 | 8 | 25 | 1 | 25,02 |

Stainless steel lid. – Coperchio inox.



SS

Tea strainer

Passathé
Teesieb
Passoire à thé
Colador de tè

| art. | Ø cm. | € |
|----------|-------|-------|
| 41529-05 | 5 | 58,09 |



SS

Tea strainer

Passathé
Teesieb
Passoire à thé
Colador de tè

| art. | Ø cm. | € |
|----------|-------|-------|
| 41530-05 | 5 | 80,70 |



SS

Tea strainer

Passathé
Teesieb
Passoire à thé
Colador de tè

| art. | Ø cm. | € |
|----------|-------|-------|
| 41530-11 | 5 | 35,58 |



SS

Tea strainer

Passathé
Teesieb
Passoire à thé
Colador de tè

| art. | Ø cm. | € |
|----------|-------|------|
| 41530-07 | 7,5 | 9,25 |



SS

Tea strainer

Passathé
Teesieb
Passoire à thé
Colador de tè

| art. | Ø cm. | € |
|----------|-------|------|
| 42617-04 | 4,5 | 3,92 |
| 42617-05 | 5,0 | 4,22 |
| 42617-06 | 6,5 | 4,92 |
| 42617-07 | 7,5 | 5,13 |



SS

Toast rack

Portatoast
Toastständer
Support pour toast
Porta tostadas

| art. | dim. cm. | € |
|----------|-----------|-------|
| 41599-08 | 20x11x5,7 | 18,89 |



SS

Egg cup

Portauovo
Eierbecher
Coquetier
Soporte huevos

| art. | Ø cm. | € |
|----------|-------|------|
| 41598-00 | 8,5 | 4,42 |



MF

Egg cup, 4 pcs set

Portauovo, set 4 pz
Eierbecher, 4 Stk
Coquetier, set 4 pcs
Soporte huevos, set 4 pz

| art. | Ø cm. | € |
|----------|-------|-------|
| 41597-04 | 8,5 | 12,86 |



SS
PR

Mustard cup
Senapiera
Senfschale
Moutardier
Mostacero

| art. | Ø cm. | € |
|----------|-------|-------|
| 41564-07 | 7 | 44,72 |



SS
PR

Butter cup
Coppa burro
Butterservierer
Coupe à beurre
Copa mantequilla

| art. | Ø cm. | € |
|----------|-------|-------|
| 41563-07 | 7 | 32,16 |



SS
PR

Butter cup
Coppa burro
Butterservierer
Coupe à beurre
Copa mantequilla

| art. | Ø cm. | € |
|----------|-------|-------|
| 41561-09 | 9 | 25,83 |



SS

Gravy boat with foot
Salsiera con piede
Saucière mit Fuss
Saucière sur pied
Salsera con pie

| art. | lt. | € |
|----------|------|-------|
| 41615-01 | 0,15 | 10,95 |
| 41615-03 | 0,25 | 14,07 |
| 41615-05 | 0,45 | 17,69 |



PR

Soup bowl, lion-headed
Ciotola testa di leone
Suppentasse Löwenkopf
Soupière tête de lion
Tazón cabeza de león

| art. | Ø cm. | lt. | € |
|----------|-------|------|-------|
| 44379-03 | 11 | 0,35 | 16,48 |
| 44379-05 | 17 | 0,50 | 18,69 |



PC

Salad bowl
Insalatiera
Salatschüssel
Saladier
Bol para ensalada

| art. | Ø cm. | h. cm. | lt. | € |
|----------|-------|--------|------|-------|
| 44950-15 | 15,2 | 5,0 | 0,6 | 4,72 |
| 44950-20 | 20,3 | 6,5 | 1,7 | 7,34 |
| 44950-25 | 25,4 | 8,0 | 3,0 | 10,15 |
| 44950-30 | 30,5 | 10,0 | 5,5 | 14,97 |
| 44950-38 | 38,1 | 12,5 | 10,6 | 21,71 |



SS

Fruit basket, oval
Cesto frutta, ovale
Obstschale, oval
Panier à fruits, ovale
Cesta fruta, oval

| art. | dim. cm. | € |
|----------|----------|-------|
| 42956-19 | 19x15 | 22,41 |
| 42956-24 | 24,5x18 | 27,64 |
| 42956-28 | 28x21 | 30,45 |



SS

Fruit basket, round
Cesto frutta, tondo
Obstschale, rund
Panier à fruits, rond
Cesta fruta, redonda

| art. | Ø cm. | € |
|----------|-------|-------|
| 41629-17 | 17,0 | 22,21 |
| 41629-20 | 20,0 | 26,93 |
| 41629-25 | 25,5 | 31,36 |



NEW

Bread basket, cotton linen
Cesto pane, fodera cotone
Brotkorb, Baumwollfutter
Panier, doublure en coton
Cesta pan, forro de algodón

| art. | Ø cm. | h. cm. | € |
|----------|-------|--------|-------|
| 42881-24 | 24 | 8 | 15,38 |

Powder coated metal.
Metallo verniciato a polvere.



NEW

Bread basket, cotton linen
Cesto pane, fodera cotone
Brotkorb, Baumwollfutter
Panier, doublure en coton
Cesta pan, forro de algodón

| art. | dim. cm. | € |
|----------|----------|-------|
| 42881-25 | 25x20x8 | 14,77 |

Powder coated metal.
Metallo verniciato a polvere.



NEW

Bread basket, cotton linen
Cesto pane, fodera cotone
Brotkorb, Baumwollfutter
Panier, doublure en coton
Cesta pan, forro de algodón

| art. | dim. cm. | € |
|----------|----------|-------|
| 42881-26 | 24x20x8 | 15,08 |

Powder coated metal.
Metallo verniciato a polvere.



Wire basket, cotton linen
Cesto in filo, fodera cotone
Drahtkorb, Baumwollfutter
Panier métallique, doublure en coton
Cesta de alambre, forro de algodón

| art. | dim. cm. | € |
|----------|------------|------|
| 42878-17 | 17x12,5x8 | 6,73 |
| 42878-25 | 25x15,5x12 | 9,05 |



Wire basket, cotton linen

Cesto in filo, fodera cotone
Drahtkorb, Baumwollfutter
Panier métallique, doublure en coton
Cesta de alambre, forro de algodón

| art. | dim. cm. | € |
|----------|-----------|------|
| 42877-17 | 17x12,5x8 | 6,83 |
| 42877-25 | 25x17x12 | 9,75 |



Kraft paper bag, washable

Cesto pane di carta kraft lavabile
Kraftpapierbrottasche, waschbar
Panier en papier kraft lavable
Cesta pan de papel kraft lavable

| art. | Ø cm. | h. cm. | € |
|----------|-------|--------|------|
| 42879M12 | 12 | 12 | 3,02 |
| 42879M15 | 15 | 10 | 3,92 |
| 42879M22 | 22 | 13 | 5,63 |
| 42879M25 | 25 | 18 | 6,93 |



Kraft paper bag, washable

Cesto pane di carta kraft lavabile
Kraftpapierbrottasche, waschbar
Panier en papier kraft lavable
Cesta pan de papel kraft lavable

| art. | Ø cm. | h. cm. | € |
|----------|-------|--------|------|
| 42879K12 | 12 | 12 | 3,02 |
| 42879K15 | 15 | 10 | 3,92 |
| 42879K22 | 22 | 13 | 5,63 |
| 42879K25 | 25 | 18 | 6,93 |



Bread basket

Cesto pane
Brotkorb
Corbeille à pain
Cesta pan

| art. | Ø cm. | h. cm. | € |
|----------|-------|--------|------|
| 42948-18 | 10 | 7 | 2,41 |
| 42948-20 | 20 | 7 | 2,61 |
| 42948-25 | 25 | 7 | 3,02 |



Bread basket

Cesto pane
Brotkorb
Corbeille à pain
Cesta pan

| art. | dim. cm. | € |
|----------|-----------|------|
| 42948-23 | 23x15x6,5 | 3,12 |



Bread basket

Cesto pane
Brotkorb
Corbeille à pain
Cesta pan

| art. | Ø cm. | h. cm. | € |
|----------|-------|--------|------|
| 42935-19 | 19 | 9 | 6,73 |
| 42935-26 | 26 | 9 | 8,04 |



Bread basket

Cesto pane
Brotkorb
Corbeille à pain
Cesta pan

| art. | Ø cm. | h. cm. | € |
|----------|-------|--------|------|
| 42944-23 | 23 | 7 | 5,23 |



Bread basket

Cesto pane
Brotkorb
Corbeille à pain
Cesta pan

| art. | dim. cm. | € |
|----------|----------|------|
| 42945-27 | 27x20x10 | 5,63 |



Bread basket

Cesto pane
Brotkorb
Corbeille à pain
Cesta pan

| art. | dim. cm. | € |
|----------|-----------|------|
| 42945-18 | 18x13x6,5 | 2,21 |
| 42945-23 | 23x15x6,5 | 2,71 |



Bread basket

Cesto pane
Brotkorb
Corbeille à pain
Cesta pan

| art. | Ø cm. | h. cm. | col. | € |
|----------|-------|--------|------|------|
| 42974B13 | 13 | 10 | ● | 8,04 |
| 42974M13 | 13 | 10 | ● | 8,04 |



Canvas bag, round

Cesto cotone, rotondo
Brottasche, rund, Baumwolle
Panier à pain rond, coton
Cesta pan redonda, algodón

| art. | Ø cm. | h. cm. | col. | € |
|----------|-------|--------|------|-------|
| 42875-17 | 17 | 11 | ● | 11,86 |
| 42875-20 | 20 | 12 | ● | 13,07 |

Cotton, machine-washable up to 30° C.
Cotone, lavabile a macchina fino a 30° C.



Canvas bag, round

Cesto cotone, rotondo
Brottasche, rund, Baumwolle
Panier à pain rond, coton
Cesta pan redonda, algodón

| art. | Ø cm. | h. cm. | col. | € |
|----------|-------|--------|------|-------|
| 42875B17 | 17 | 11 | ● | 12,36 |
| 42875B20 | 20 | 12 | ● | 13,67 |

Cotton, machine-washable up to 30° C.
Cotone, lavabile a macchina fino a 30° C.



NEW

Canvas bag, round

Cesto cotone, rotondo
Brottasche, rund, Baumwolle
Panier à pain rond, coton
Cesta pan redonda, algodón

| art. | Ø cm. | h. cm. | col. | € |
|----------|-------|--------|------|------|
| 42876-12 | 12 | 15 | ● | 6,23 |

Cotton, machine-washable up to 30° C.
Cotone, lavabile a macchina fino a 30° C.



Canvas bag, oval

Cesto cotone, ovale
Brottasche, oval, Baumwolle
Panier à pain ovale, coton
Cesta pan , algodón

| art. | dim. cm. | col. | € |
|----------|----------|------|-------|
| 42876-20 | 20x15x10 | ● | 12,26 |
| 42876-25 | 25x18x12 | ● | 14,67 |

Cotton, machine-washable up to 30° C.
Cotone, lavabile a macchina fino a 30° C.



Canvas bag, round

Cesto cotone, rotondo
Brottasche, rund, Baumwolle
Panier à pain, coton
Cesta pan, algodón

| art. | Ø cm. | h. cm. | col. | € |
|----------|-------|--------|------|-------|
| 42873-01 | 19 | 23 | ● | 35,48 |

Ceramic stone pillow included. Easy to heat up in microwave for 90 sec. at 500 Watt. – Cuscino con sfere ceramica incluso. Scaldare in microonde per 90 secondi a 500 Watt.



Canvas bag, round

Cesto cotone, rotondo
Brottasche, rund, Baumwolle
Panier à pain, coton
Cesta pan, algodón

| art. | Ø cm. | h. cm. | col. | € |
|----------|-------|--------|------|-------|
| 42873-02 | 19 | 23 | ● | 35,48 |

Ceramic stone pillow included. Easy to heat up in microwave for 90 sec. at 500 Watt. – Cuscino con sfere ceramica incluso. Scaldare in microonde per 90 secondi a 500 Watt.



Bowl, oval

Ciotola ovale
Schüssel, oval
Bassine ovale
Bol oval

| art. | dim. cm. | € |
|----------|----------|------|
| 42931-19 | 19,5x17 | 2,01 |



Truffle-slicer

Tagliatartufi
Trüffelschneider
Coupe-truffles
Corta trufa

| art. | dim. cm. | des. | € |
|----------|----------|----------|-------|
| 48237-00 | 21x8,5 | plain | 33,37 |
| 48237-01 | 21x8,5 | serrated | 33,27 |



Truffle-slicer

Tagliatartufi
Trüffelschneider
Coupe-truffles
Corta trufa

| art. | dim. cm. | des. | € |
|----------|----------|----------|-------|
| 48236-00 | 21x8,5 | plain | 43,42 |
| 48236-01 | 21x8,5 | serrated | 44,82 |

Rosewood handle. – Manico in palissandro.



Truffle jar

Contentitore tartufi
Trüffel-Verpackung
Réceptif à truffes
Envasado para trufa

| art. | Ø cm. | h. cm. | € |
|----------|-------|--------|------|
| 48237-99 | 6 | 4,5 | 9,95 |

For transport and storage, prevents weight loss.
Per trasporto e conservazione, previene il calo di peso.



Truffle server
Servitartufi
Trüffel-Service
Service à truffes
Servidor de trufas

| art. | dim. cm. | € |
|----------|----------|--------|
| 48237-35 | 30x20x9 | 196,78 |

Chesnut wood. – Castagno.



Tray with dome cover
Vassoio con campana
Tablett mit Haube
Plat avec cloche
Bandeja con campana

| art. | Ø cm. | h. cm. | € |
|----------|-------|--------|---|
| 41416-18 | 18,5 | 24,5 | - |

Beech wood tray with glass cover Ø 16 H 22,5 cm. – Vassoio in legno di faggio con coperchio in vetro Ø 16 H 22,5 cm.



Salt/pepper shaker set
Set spargisale/pepe
Salz- und Pfefferstreuer-Set
Set salière et poivrier
Juego salero y pimentero

| art. | Ø cm. | h. cm. | € |
|----------|-------|--------|------|
| 42924-02 | 5 | 6,5 | 5,03 |

SS



Condiment set, 2 pcs
Set 2 pz sale e pepe
Menage, 2-teilig
Ménagère, 2 pièces
Servicio de mesa, 2 piezas

| art. | dim. cm. | gr. | € |
|----------|----------|-----|------|
| 42927-02 | 3x3x5 | 14 | 3,82 |

Universal holes. – Fori universali.

SS



Salt/pepper shaker, chrome top
Spargisale/pepe cromato
Salz-/Pfefferstreuer, verchromt
Salière/poivrier, chromé
Salero/pimentero, cromado

| art. | Ø cm. | h. | gr. | € |
|----------|-------|----|-----|------|
| 42928-00 | 4,5 | 11 | 57 | 3,32 |

Universal holes. – Fori universali.



Salt/pepper shaker, set 12 pcs
Spargisale/pepe, set 12 pz
Salz-/Pfefferstreuer, 12 Stk
Salière/poivrier, set 12 pcs
Salero/pimentero, juego 12 pz

| art. | Ø cm. | h. cm. | € |
|----------|-------|--------|-------|
| 42926-12 | 3 | 9 | 30,05 |

SS



Salt shaker
Spargisale
Salzstreuer
Salière
Salero

| art. | Ø cm. | h. cm. | € |
|----------|-------|--------|-------|
| 42922-08 | 8 | 17 | 23,52 |

For french fries, cover to screw.
Per patatine fritte, coperchio a vite.

NEW

SS



Condiment set, 2 pcs
Sale e pepe, 2 pezzi
Menage, 2-teilig
Ménagère, 2 pièces
Servicio de mesa, 2 piezas

| art. | dim. cm. | € |
|----------|-------------|-------|
| 42929-01 | 11,5x5,5x17 | 29,85 |

Wood base, satin polished handle.
Base legno, manico satinato.

SS



Condiment set, 2 pcs
Servizio oliera, 2 pezzi
Menage, 2-teilig
Ménagère, 2 pièces
Servicio de mesa, 2 piezas

| art. | dim. cm. | € |
|----------|-------------|-------|
| 42929-02 | 16x7,5x24,5 | 44,62 |

Wood base, satin polished handle.
Base legno, manico satinato.

SS



SS

Condiment set, 4 pcs

Servizio oliera, 4 pezzi
Menage, 4-teilig
Ménagère, 4 pièces
Servicio de mesa, 4 piezas

| art. | dim. cm. | € |
|----------|--------------|-------|
| 42929-03 | 15,5x12x24,5 | 59,60 |

Wood base, satin polished handle.
Base legno, manico satinato.



SS

Oil/vinegar sprayer, 2 pcs

Nebulizzatore olio/acetato, 2 pz
Öl-/Essigsprühflasche, 2 Stück
Nébuliseur huile vinaigre, 2 pièces
Nebulizador aceite/vinagre, 2 pz

| art. | Ø cm. | h. cm. | ml. | € |
|----------|-------|--------|-----|-------|
| 41635-02 | 4 | 18 | 110 | 14,37 |



SS

Oil and vinegar stand

Porta olio/acetato
Essig u. Öl-Stand
Porte huile et vinaigre
Soporte para aceite y vinagre

| art. | dim. cm. | € |
|----------|-----------|-------|
| 66362-02 | 12,5x6x27 | 73,57 |



SS

Condiment set, 4 pcs

Servizio oliera, 4 pezzi
Menage, 4-teilig
Ménagère, 4 pièces
Servicio de mesa, 4 piezas

| art. | dim. cm. | € |
|----------|--------------|-------|
| 41638-04 | 17,5x10,5x23 | 56,08 |



SS

Condiment set, 2 pcs

Servizio oliera, 2 pezzi
Menage, 2-teilig
Ménagère, 2 pièces
Servicio de mesa, 2 piezas

| art. | dim. cm. | € |
|----------|-------------|-------|
| 41638-02 | 14,5x8,5x23 | 47,84 |



SS

Condiment set, 2 pcs

Sale e pepe, 2 pezzi
Menage, 2-teilig
Ménagère, 2 pièces
Servicio de mesa, 2 piezas

| art. | dim. cm. | € |
|----------|-------------|-------|
| 41638-12 | 10,5x6,5x16 | 30,75 |



SS

Condiment set, 3 pcs

Set sale, pepe, stecchi
Menage, 3-teilig
Ménagère, 3 pièces
Servicio de mesa, 3 piezas

| art. | Ø cm. | h. cm. | € |
|----------|-------|--------|-------|
| 41638-13 | 10,5 | 16 | 38,79 |



SS

Cheese jar

Formaggiera
Käsedose
Fromagère
Quesera

| art. | Ø cm. | h. cm. | € |
|----------|-------|--------|-------|
| 41638-01 | 10,5 | 7 | 33,97 |



SS

Cheese shaker
Spargiformaggio
Käsestreuer
Poudreuse à fromage
Colteler de queso

| art. | ml. | € |
|----------|-----|------|
| 42921-00 | 360 | 4,82 |



PP

Cutlery/breadstick basket
Portaposate/grissini
Besteck-/Salzstangenkorb
Panier à couverts/gressins
Cesta cubiertos/palitos de pan

| art. | Ø cm. | h. cm. | - | col. | € |
|----------|-------|--------|-----|------|------|
| 42584-01 | 12 | 15 | - | ● | 8,64 |
| 42584M01 | 12 | 15 | NEW | ● | 8,64 |



PP

Cutlery dispenser
Portaposate
Besteck-Ablage
Panier à couverts
Cesta portacubiertos

| art. | dim. cm. | - | col. | € |
|----------|-----------|-----|------|------|
| 42584-02 | 27x10x4,5 | - | ● | 9,35 |
| 42584M02 | 27x10x4,5 | NEW | ● | 9,35 |



PP

Cutlery dispenser
Portaposate
Besteck-Ablage
Panier à couverts
Cesta portacubiertos

| art. | dim. cm. | - | col. | € |
|----------|------------|-----|------|-------|
| 42584-04 | 53x32,5x10 | - | ● | 49,45 |
| 42584M04 | 53x32,5x10 | NEW | ● | 49,45 |



PP

Cutlery dispenser
Portaposate
Besteck-Ablage
Panier à couverts
Cesta portacubiertos

| art. | dim. cm. | - | col. | € |
|----------|-----------|-----|------|-------|
| 42584B05 | 53x32,5x9 | NEW | ● | 56,18 |
| 42584-05 | 53x32,5x9 | - | ● | 56,18 |



PP

Cutlery dispenser
Portaposate
Besteck-Ablage
Panier à couverts
Cesta portacubiertos

| art. | dim. cm. | col. | € |
|----------|----------|------|-------|
| 42584-06 | 26x18x15 | ● | 22,11 |
| 42584-07 | 26x18x15 | ● | 22,11 |



W

Table caddy
Portacondimenti
Tisch-Caddy
Caddy de table
Caddy de mesa

| art. | Ø cm. | h. cm. | € |
|----------|-------|--------|-------|
| 41639-17 | 17,5 | 8,5 | 13,77 |



W

Cutlery dispenser
Portaposate
Besteck-Ablage
Panier à couverts
Cesta portacubiertos

| art. | Ø cm. | h. cm. | € |
|----------|-------|--------|-------|
| 41639-11 | 11,5 | 14 | 14,17 |



W

Table caddy 4 compartments
Portacondimenti 4 comparti
Tisch-Caddy 4-Fächer
Caddy de table 4 compartiments
Caddy de mesa 4 compartimentos

| art. | dim. cm. | col. | € |
|----------|----------|------|-------|
| 41639-30 | 17x17x10 | ○ | 14,47 |
| 41639-31 | 17x17x10 | ● | - |

Compartments/Scomparti 7x7 cm.



W

Table caddy 6 compartments
Portacondimenti 6 comparti
Tisch-Caddy 6-Fächer
Caddy de table 6 compartiments
Caddy de mesa 6 compartimentos

| art. | dim. cm. | col. | € |
|----------|----------|------|-------|
| 41639-40 | 27x17x10 | ○ | 16,68 |
| 41639-41 | 27x17x10 | ● | 15,88 |
| 41639-42 | 27x17x10 | ● | 15,88 |

Compartments/Scomparti 7,5x7,5 cm.



SS

Table-cloth clips, 4 pcs set
Fermatovaglia, set 4 pz
Tischtuch Klammer, 4 Stk
Pincas à nappe, 4 pièces
Pinzas para mantel, 4 piezas

| art. | € |
|----------|------|
| 42953-04 | 2,61 |

For table/Per tavoli h 3 cm.



SS

Napkin holder
Legatovagliolo
Serviettenring
Porteserviette
Servilletero

| art. | € |
|----------|------|
| 42955-00 | 3,32 |



SS

Dome cover

Cloche
Speiseglocke
Cloche
Cubreplatos

| art. | Ø cm. | h. cm. | € |
|----------|-------|--------|-------|
| 41560-28 | 29 | 18 | 90,45 |



SS

ABS

Pocket crumbler

Raccoglibriciole tascabile
Krümelsammler taschenformat
Ramasse miettes de poche
Recogemigas de bolsillo

| art. | dim. cm. | € |
|----------|----------|------|
| 42593-00 | 14x2,7 | 7,94 |



SS

Table crumbler

Raccoglibriciole a tubo
Krümelsammler
Ramasse miettes
Pala recogemigas

| art. | dim. cm. | € |
|----------|----------|-------|
| 41679-23 | 23,5 | 35,48 |



Raclette maker, 4 pans

Macchina per raclette, 4 padelle
Raclette Tischgerät, 4 Pfannen
Appareil à raclette, 4 poêlons
Máquina raclette

| art. | dim. cm. | W | € |
|----------|----------|-----|--------|
| 41318-00 | 51x10x12 | 600 | 211,35 |

Non-stick upper plate for all cooking (vegetables, meats, etc.). – Piastra superiore antiaderente per tutte le cotture (verdure, carne, ecc.).



Raclette maker

Macchina per raclette
Raclette Tischgerät
Appareil à raclette
Máquina raclette

| art. | dim. cm. | W | € |
|----------|--------------|-----|--------|
| 42420-06 | 44,5x21,5x30 | 850 | 431,04 |

Adjustable height. Suitable for cheese size 1/6 to 1/3 of a wheel. In stainless steel and painted steel. – Altezza regolabile. Per da 1/6 a 1/3 di una forma. In acciaio inossidabile e acciaio verniciato.



Raclette maker

Macchina per raclette
Raclette Tischgerät
Appareil à raclette
Máquina raclette

| art. | dim. cm. | W | € |
|----------|------------|-----|--------|
| 42420-08 | 46x26,5x40 | 850 | 316,88 |

Tiltable cheese holder. Adjustable height. Ideal for 6-8 people, 1/2 shape. Cheese holder in s/s and epoxy painted steel structure. – Porta formaggio inclinabile. Altezza regolabile. Ideale per 6-8 persone, 1/2 forma. Porta formaggio inox e struttura in acciaio verniciato epossidico.



Fondue set, copper

Set fonduta, rame
Fondue-Service, Kupfer
Service à fondue, cuivre
Servicio para fondues, cobre

| art. | Ø cm. | h. cm. | lt. | € |
|----------|-------|--------|------|--------|
| 15430-11 | 16 | 26 | 1,45 | 474,66 |



Cheese fondue set

Set fonduta formaggio
Käsefondue-Service
Service à fondue fromage
Servicio para fondues queso

| art. | Ø cm. | h. cm. | lt. | € |
|----------|-------|--------|-----|-------|
| 41311-00 | 20 | 18 | 1 | 49,25 |



SS

Fondue set 13 pcs

Set fonduta 13 pz
Fondue-Service 13 Stk
Service à fondue 13 pcs
Servicio para fondues 13 pz

| art. | Ø cm. | h. cm. | lt. | € |
|----------|-------|--------|-----|-------|
| 41312-00 | 22 | 23 | 2,2 | 89,34 |

**TABLE TOP TAVOLA
SERVING ITEMS COMPLEMENTI**



Dipping forks, 6 pcs

Set forchette, 6 pz
Fonduegabeln, 6 Stk
Curettes à fondue, 6 pièces
Tenedores para fondue, 6 pz

| art. | l. cm. | € |
|----------|--------|-------|
| 15428-06 | 24 | 17,79 |



SS

Stand with grill stone

Supporto con pietra ollare
Träger mit Kochstein
Pierre à cuire avec support
Soporte con piedra

| art. | dim. cm. | € |
|----------|----------|-------|
| 41315-02 | 17x20x12 | 44,22 |



SS

Table barbecue

Barbecue da tavola
Tischgrillplatte
Barbecue de table
Parrilla de mesa

| art. | dim. cm. | € |
|----------|------------|--------|
| 44227-30 | 25x38x11,5 | 145,93 |

Hot plate/Griglia 22x30 cm. Enmelled cast iron and beechwood. – Ghisa smaltata e legno di faggio.



SS

Table barbecue, 1 closed side

Barbecue da tavola, da esterno
Tischgrill, 1 geschlossene Seite
Barbecue de table 1 foyer fermé
Barbacoa de mesa, 1 lado cerrado

| art. | dim. cm. | Kg. | € |
|----------|----------|-----|--------|
| 41313-00 | 33x22x20 | 7,3 | 407,63 |

Also for outdoor use. Solid beech board. Can be put in the dishwasher once disassembled. – Anche per uso all'esterno. Tagliere in faggio massiccio. Può essere lavato in lavastoviglie una volta smontato.



SS

Table barbecue, 2 open sides

Barbecue da tavola, da interno
Tischgrill, 2 offene Seiten
Barbecue de table 2 foyers ouverts
Barbacoa de mesa, 2 lados abiertos

| art. | dim. cm. | Kg. | € |
|----------|----------|-----|--------|
| 41314-00 | 33x22x20 | 7,3 | 449,34 |

2 open sides for indoor use. Solid beech board. Can be put in the dishwasher once disassembled. Supplied with 1 steel pan Ø cm 18 and 1 spatula. 2 lati aperti per uso interno. Tagliere faggio massiccio. Lavabile in lavastoviglie una volta smontato. Fornito con 1 padella di ferro Ø cm 18 e 1 spatola.



SS

Plate warmer

Rechaud
Speisenwärmer
Chauffe-plats
Calentador de platos

| art. | Ø cm. | h. cm. | € |
|----------|-------|--------|---|
| 41317-20 | 20 | 11 | - |

Burning time 2 hours with an average flame. Tempo di combustione 2 ore a fiamma media.



NEW

SS

Plate warmer

Rechaud
Speisenwärmer
Chauffe-plats
Calentador de platos

| art. | dim. cm. | € |
|----------|----------|-------|
| 41569-34 | 34x13x6 | 22,21 |



Mussel pot, enamel cast-iron

Cocotte per molluschi, ferro smaltato
Muscheltopf, emaillierts Stahlblech
Casserole coquillage, émaillée
Cacerola para mejillones, esmaltada

| art. | Ø cm. | h. cm. | lt. | € |
|----------|-------|--------|------|-------|
| 42414-05 | 13,5 | 9,0 | 0,75 | 18,29 |
| 42414-10 | 18,0 | 12,0 | 2,60 | 25,33 |
| 42414-15 | 20,0 | 13,0 | 3,30 | 28,64 |
| 42414-20 | 24,0 | 13,5 | 5,20 | 33,77 |

Not suitable for cooking.
Non idonee alla cottura.



Trivet, cork

Sottopentola, sughero
Korkuntersetzer
Sous-plat, liège
Posavasos de corcho

| art. | Ø cm. | € |
|----------|-------|-------|
| 42413-24 | 24 | 23,01 |



Stand with 4 skewers

Supporto con 4 spiedini
Träger mit 4 Fleischspiesen
Support avec 4 brochettes
Soporte con 4 brochetas

| art. | Ø cm. | h. cm. | € |
|----------|-------|--------|-------|
| 42417-22 | 22 | 46 | 44,32 |



Swing table top waste bin

Portarifiuti da tavola
Tischeimer
Poubelle dé table
Papelera sobremesa, plástico

| art. | Ø cm. | h. cm. | € |
|----------|-------|--------|-------|
| 42959-13 | 12 | 18 | 11,16 |



Swing table top waste bin

Portarifiuti da tavola
Tischeimer
Poubelle dé table
Papelera sobremesa

| art. | Ø cm. | h. cm. | € |
|----------|-------|--------|-------|
| 42959-12 | 12 | 17 | 32,06 |



Nut-cracker

Schiaccianoci
Nussknacker
Casse-noix
Cascanueces

| art. | € |
|----------|------|
| 48211-00 | 9,55 |



Nut-cracker

Schiaccianoci
Nussknacker
Casse-noix
Cascanueces

| art. | l. cm. | € |
|----------|--------|-------|
| 48210-00 | 15,3 | 19,40 |



Lobster cracker

Pinza aragosta
Hummerzange
Pince à homard
Pinza bogavante

| art. | l. cm. | € |
|----------|--------|-------|
| 48239-00 | 20 | 26,63 |



Lobster cracker, aluminum

Pinza aragosta, alluminio
Hummerzange, Aluminium
Pince à homard, alu
Pinza bogavante, aluminio

| art. | dim. cm. | € |
|----------|----------|------|
| 48240-00 | 14,5x6,5 | 4,82 |



Sea urchin cutter

Taglia ricci di mare
Seeigel-Messer
Coupe oursin
Cortador de erizo de mar

| art. | dim. cm. | € |
|----------|----------|-------|
| 48286-68 | 6x22 | 25,83 |



Lobster pick

Stiletto aragosta
Hummergabel
Curette à homard
Tenedor bogavante

| art. | l. cm. | € |
|----------|--------|------|
| 48238-00 | 20 | 6,53 |



Lobster forks

Forchettine per aragosta
Hummergäbelchen
Curettes à homard
Tenedores bogavante

| art. | dim. cm. | U. Pack | € |
|----------|----------|---------|------|
| 41594-18 | 18 | 5 | 5,43 |



SS

Picks, set 12 pcs

Spilloncini, set 12 pz
Stocher, 12 Stk.
Pic-bigorneaux, set 12 pcs
Pico-caracoles, juego 12 pz

| art. | € |
|----------|------|
| 41594-12 | 6,53 |



SS

Escargot picks, chromed, set 12 pcs

Forchettine lumache, cromate, set 12 pz
Schneckenabel, verchromed, 12 Stk.
Pic-escargots, chromés, set 12 pcs
Pico-caracoles, cromados, juego 12 pz

| art. | l. cm. | € |
|----------|--------|------|
| 41686-12 | 8 | 5,33 |



PR

Escargot dish

Piatto lumache
Schneckenplatte
Plat à escargots
Plato caracoles

| art. | Ø cm. | cap. | € |
|----------|-------|------|-------|
| 44378-06 | 19 | 6 | 15,98 |



SS

Escargot dish

Piatto lumache
Schneckenplatte
Plat à escargots
Plato caracoles

| art. | Ø cm. | cap. | € |
|----------|-----------|------|-------|
| 41687-06 | 15,5/17,5 | 6 | 11,76 |
| 41687-12 | 19/22,5 | 12 | 15,68 |



SS

Caviar cooler

Coppa caviale
Kaviarkühler
Rafraîchisseur à caviar
Copa caviar

| art. | Ø cm. | h. cm. | € |
|----------|-------|--------|-------|
| 41562-18 | 18 | 12 | 94,57 |

Glass bowl Ø 10 cm. – Ciotola vetro Ø 10 cm.



Caviar flatware, mother of pearl

Posate caviale, madreperla
Kaviar-Bestecke, Perlmuttern
Couverts à caviar, nacre
Cuberteria caviar, nácar

| art. | des. | l. cm. | € |
|----------|-------|--------|-------|
| 41518-00 | spoon | 9 | 18,69 |
| 41518-01 | knife | 9 | 18,69 |
| 41518-02 | fork | 9 | 18,69 |



Seafood display rack, chromed

Supporto acciaio cromato
Unterteil für Austernplatte, verchromt
Support en fil chromé
Soporte cromado para fuente mariscos

| art. | Ø cm. | h. cm. | € |
|----------|-------|--------|-------|
| 41593-20 | 19-25 | 20 | 12,06 |



Oyster tray, aluminum

Vassoio frutti di mare, alluminio
Austernplatte, Aluminum
Plat à huîtres, alu
Fuente de mariscos, aluminio

| art. | Ø cm. | h. cm. | € |
|----------|-------|--------|-------|
| 41591-32 | 32 | 6 | 33,47 |
| 41591-36 | 36 | 6 | 37,49 |
| 41591-40 | 40 | 6 | 44,12 |
| 41591-45 | 45 | 6 | 55,07 |



SS

Oyster tray

Vassoio frutti di mare
Austernplatte
Plat à huîtres
Fuente de mariscos

| art. | Ø cm. | h. cm. | € |
|----------|-------|--------|-------|
| 41592-36 | 36 | 4,0 | 30,85 |
| 41592-45 | 45 | 5,5 | 72,26 |



SS

Oyster tray

Vassoio frutti di mare
Austernplatte
Plat à huîtres
Fuente de mariscos

| art. | Ø cm. | € |
|----------|-------|--------|
| 41591-90 | 45-36 | 156,78 |



SS

Table bag holder

Gancio appendi borsa
Handtaschentischhänger
Crochet de table
Colgador de bolso

| art. | € |
|----------|------|
| 41559-04 | 9,55 |



Wine bucket table clip, chrome
Supporto secchio vino tavola, cromato
Weinkühler-Tischbefestigung, verchromt
Porte-seau à vin, chromé
Soporte de mesa cubo vino, cromado

| art. | € |
|----------|-------|
| 41558-00 | 31,05 |

Per/For: 41501-20, 41502-20.



Wine cooler
Secchio vino
Weinkühler
Seau à vin
Cubo vino

| art. | dim. cm. | h. cm. | € |
|----------|----------|--------|-------|
| 44946-29 | 29x19,5 | 19,5 | 22,51 |

AY



Bottle cooler
Spumantiera
Flaschenkühler
Rafraichisseur à bouteilles
Cubitera

| art. | dim. cm. | h. cm. | € |
|----------|----------|--------|-------|
| 44946-40 | 40,5x30 | 25 | 47,13 |

AY



Wine cooler
Secchio vino
Weinkühler
Seau à vin
Cubo vino

| art. | Ø cm. | h. cm. | € |
|----------|-------|--------|-------|
| 44946-20 | 20 | 23 | 22,51 |

AY



Wine cooler
Secchio vino
Weinkühler
Seau à vin
Cubo vino

| art. | Ø cm. | h. cm. | € |
|----------|-------|--------|-------|
| 41516-20 | 20-16 | 24 | 52,46 |

SS



Wine cooler
Secchio vino
Weinkühler
Seau à vin
Cubo vino

| art. | Ø cm. | h. cm. | col. | € |
|----------|-------|--------|------|-------|
| 41516G20 | 20-16 | 24 | ● | 75,98 |
| 41516C20 | 20-16 | 24 | ● | 75,98 |

SS



Wine bucket
Secchiello vino
Weinkühler
Seau à vin
Cubo vino

| art. | Ø cm. | h. cm. | € |
|----------|-------|--------|-------|
| 41502-20 | 20-15 | 20 | 63,32 |

SS



Wine cooler
Secchiello vino
Weinkühler
Seau à vin
Cubo vino

| art. | Ø cm. | h. cm. | bot. | € |
|-----------|---------|--------|------|--------|
| 46120-18● | 17-12,5 | 16 | 1/2 | 109,44 |
| 46120-22● | 21,5-16 | 21 | 1 | 150,35 |
| 46120-24● | 24-19 | 22 | 2 | 163,21 |

SS



White wine cooler
Secchio vino bianco
Weissweinkühler
Seau à vin blanc
Cubo vino blanco

| art. | Ø cm. | h. cm. | € |
|-----------|-------|--------|--------|
| 46118-20● | 20 | 25 | 156,08 |

SS



Wine bucket, aluminum

Secchiello vino, alluminio
Weinkühler, Aluminium
Seau à vin, alu
Cubo vino, alluminio

| art. | dim. cm. | lt. | bot. | col. | € |
|----------|------------|-----|------|------|-------|
| 41507C03 | 20,5x14x17 | 2,1 | 1 | ● | 40,70 |
| 41507B03 | 20,5x14x17 | 2,1 | 1 | ● | 40,70 |

Hammered surface. – Superficie martellata.



Wine bucket, aluminum

Secchiello vino, alluminio
Weinkühler, Aluminium
Seau à vin, alu
Cubo vino, alluminio

| art. | dim. cm. | lt. | bot. | col. | € |
|----------|------------|-----|------|------|-------|
| 41507C04 | 25,5x19x20 | 3,9 | 1/2 | ● | 54,77 |
| 41507B04 | 25,5x19x20 | 3,9 | 1/2 | ● | 54,77 |

Hammered surface. – Superficie martellata.



Wine bucket, aluminum

Secchiello vino, alluminio
Weinkühler, Aluminium
Seau à vin, alu
Cubo vino, alluminio

| art. | Ø cm. | h. cm. | € |
|----------|-------|--------|-------|
| 41501-20 | 20-15 | 21 | 32,46 |



Wine cooler, aluminum

Secchiello vino, alluminio
Weinkühler, Aluminium
Seau à vin, alu
Cubo vino, alluminio

| art. | Ø cm. | h. cm. | € |
|----------|---------|--------|-------|
| 41501-23 | 23x20,5 | 22,5 | 47,54 |



Wine cooler, aluminum

Secchiello vino, alluminio
Weinkühler, Aluminium
Seau à vin, alu
Cubo vino, alluminio

| art. | Ø cm. | h. cm. | € |
|----------|-------|--------|--------|
| 41501-40 | 40,2 | 25,3 | 120,40 |

With 6 notches for glasses. – Con 6 fori portacalici.



Wine cooler stand

Colonna portasecchiello
Ständer für Weinkühler
Support seau à champagne
Soporte para cubo

| art. | Ø cm. | h. cm. | € |
|-----------|-------|--------|-------|
| 41505-00● | 20* | 67,6 | 70,25 |

* Inner diameter. – Diametro interno.



Wine cooler stand

Colonna portasecchiello
Ständer für Weinkühler
Support seau à champagne
Soporte para cubo

| art. | Ø cm. | h. cm. | € |
|-----------|-------|--------|--------|
| 41505-20● | 20* | 70,5 | 167,94 |

* Inner diameter. – Diametro interno.



Wine cooler stand

Colonna portasecchiello
Ständer für Weinkühler
Support seau à champagne
Soporte para cubo

| art. | Ø cm. | h. cm. | € |
|-----------|-------|--------|--------|
| 41505-17● | 16* | 64 | 123,41 |
| 41505-19● | 20* | 64 | 142,61 |

* Inner diameter. – Diametro interno.



NEW

Wine cooler stand

Colonna portasecchiello
Ständer für Weinkühler
Support seau à champagne
Soporte para cubo

| art. | Ø cm. | h. cm. | € |
|----------|-------|--------|--------|
| 41505B15 | 15 | 71,5 | 151,86 |

Metal, zinc die-cast. – Metallo, zinco pressofuso.



NEW

Wine cooler, aluminum

Secchio vino, alluminio
Weinkühler, Aluminum
Seau à vin, alu
Cubo vino, aluminio

| art. | Ø cm. | h. cm. | lt. | € |
|----------|---------|--------|-----|-------|
| 41509B20 | 15-21,5 | 22 | 5 | 68,84 |

ABS handles. – Maniglie ABS.



SS

Bottle cooler

Glacette termica
Flaschenkühler
Rafraîchisseur à bouteille
Enfriador isotérmico

| art. | Ø cm. | h. cm. | € |
|----------|-------|--------|-------|
| 41508C12 | 12/10 | 20 | 43,92 |



NEW

Bottle cooler, concrete

Glacette, cemento
Flaschenkühler, Beton
Rafraîchisseur à bouteille, béton
Enfriador, cemento

| art. | Ø cm. | h. cm. | - | col. | € |
|----------|-------|--------|-----|------|-------|
| 41504-19 | 12/10 | 19 | - | ● | 31,36 |
| 41504B19 | 12/10 | 19 | NEW | ● | 31,36 |



NEW

Bottle cooler, concrete

Glacette, cemento
Flaschenkühler, Beton
Rafraîchisseur à bouteille, béton
Enfriador, cemento

| art. | Ø cm. | h. cm. | col. | € |
|----------|-------|--------|------|-------|
| 41504W20 | 13/10 | 19,5 | ○ | 31,36 |
| 41504G20 | 13/10 | 19,5 | ● | 31,36 |



SS

Bottle cooler

Glacette termica
Flaschenkühler
Rafraîchisseur à bouteille
Enfriador isotérmico

| art. | Ø cm. | h. cm. | € |
|----------|-------|--------|-------|
| 41504-09 | 9,5 | 22,5 | 72,76 |



SS

Bottle cooler

Glacette termica
Flaschenkühler
Rafraîchisseur à bouteille
Enfriador isotérmico

| art. | Ø cm. | h. cm. | € |
|----------|-------|--------|-------|
| 41504-10 | 10 | 21 | 82,41 |



PP

Bottle cooler

Glacette termica
Flaschenkühler
Rafraîchisseur à bouteille
Enfriador isotérmico

| art. | Ø cm. | h. cm. | € |
|----------|-------|--------|-------|
| 41504-11 | 10 | 22 | 16,58 |



SS

Wine holder

Versavino a molla
Weingestell
Porte-Bouteille
Soporte para botella

| art. | Ø cm. | € |
|----------|-------|------|
| 41510-08 | 8 | 8,64 |



SS

Wine holder

Versavino reversibile
Weingestell
Porte-Bouteille
Soporte para botella

| art. | l. cm. | € |
|----------|--------|-------|
| 46123-00 | 17 | 44,02 |



Wine collar, chromed

Collare salvagoccia, cromato
Tropfenfänger, verchromt
Collier anti-gouttes, chromé
Anillo anti-goteo, cromado

| art. | € |
|----------|------|
| 41511-00 | 3,02 |



SS

Wine taster with ring and cord

Tastevin con anello e cordino
Weinprobenschale mit Ring und Schnur
Tastevin avec anneau et cordon
Catador del vino con anillo y cordón

| art. | Ø cm. | € |
|----------|-------|---|
| 41499-08 | 8,5 | - |



Cognac warmer, palladium

Scaldacognac, palladio
Cognacwärmer, Palladium
Réchaud à cognac, palladium
Calentador brandy, paladio

| art. | h. cm. | € |
|----------|--------|--------|
| 41678-14 | 14,5 | 102,81 |



Champagne saber

Sciabola per Sommelier
Champagnersäbel
Sabra à champagne
Sable para Champán

| art. | l. cm. | € |
|----------|--------|--------|
| 41496-40 | 40 | 149,75 |



Champagne tongs, chromed

Pinza champagne, cromata
Champagner-Zange, verchromed
Pince à champagne, chromée
Pinza Champaña, cromada

| art. | € |
|----------|-------|
| 41511-30 | 16,68 |



SS

Pourer

Versatore
Ausgießer
Verseur
Vertedor

| art. | € |
|----------|------|
| 41511-20 | 4,92 |



Flower vase, nickel plated

Vaso fiori, nichelato
Blumenvase, vernickelt
Vase à fleurs, nickelé
Florero, zinc-niquel

| art. | Ø cm. | h. cm. | € |
|----------|-------|--------|-------|
| 42942-16 | 4 | 16,5 | 25,33 |



SS

Flower vase

Vaso fiori
Blumenvase
Vase à fleurs
Florero

| art. | h. cm. | € |
|----------|--------|-------|
| 41628-15 | 15 | 37,89 |



NEW



Flower vase

Vaso fiori
Blumenvase
Vase à fleurs
Florero

| art. | dim. cm. | ml. | € |
|----------|-------------|-----|-------|
| 42942-10 | 10x4,5x12,5 | 25 | 11,46 |

Concrete and glass. – Cemento e vetro.



AG

Candelabra 5 lights

Candelabro 5 luci
Kerzenleuchter, 5-flammig
Chandelier, 5 branches
Candelabro, 5 brazos

| art. | Ø cm. | h. cm. | € |
|----------|-------|--------|---|
| 32936-05 | 13 | 39 | - |



SS

Candleholder satin finish, set 2 pcs

Portacandela satinato, set 2 pz
Windlicht, mattiert, 2er Set
Bougeoir satin mat, set 2 pcs
Portavela satinado, set 2 pz

| art. | Ø cm. | h. cm. | € |
|----------|-------|--------|---|
| 42939-15 | 5 | 15 | - |



SS

Set 4 tea light candles

Set 4 candele tea light
Kunstteelichter, 4er Set
Set 4 bougies chauffeplat
Set 4 velas de tè

| art. | Ø cm. | h. cm. | € |
|----------|-------|--------|-------|
| 42446-04 | 3,65 | 3,53 | 19,70 |

Resin. Timer function 5 hours ON/19 OFF. Powered by one CR2450 alkaline battery (not incl.). Working time >50 hours. Flameless moving wick. – Resina. Funzione timer 5 ore ON/19 OFF. 1 batteria alcalina CR2450 (non incl.). Durata > 50 ore. Stoppino mobile senza fiamma.



SS

Set 3 candele

Set 3 candles
Kunstkerzen, 3er Set
Set 3 bougies
Set 3 velas

| art. | Ø cm. | h. cm. | € |
|----------|-------|--------|-------|
| 42445-03 | 9 | 12,5 | 33,77 |
| | 9 | 18,0 | |
| | 9 | 23,0 | |

Resin. Timer function 5 hours ON/19 OFF. Powered by 2D alkaline batteries (not incl.). Working time >800 hours. Flameless moving wick. – Resina. Funzione timer 5 ore ON/19 OFF. 2 batterie alcaline D (non incluse). Durata > 800 ore. Stoppino mobile senza fiamma.



Sign holders, chromed

Clip flessibili, cromate
Schildelhalter, verchromt
Porte-étiquettes, chromés
Porta etiquetas con clip, cromate

| art. | l. cm. | pcs/pz | € |
|----------|--------|--------|------|
| 41394-02 | 12 | 1 | 5,83 |



SS

Menu stand

Porta menù
Speisekartenhalter
Porte-menu
Portamenús

| art. | dim. cm. | € |
|----------|----------|------|
| 42951-08 | 8x7x2 | 6,53 |



SS

Table number stand, 4 pcs set

Supporto numero tavola, set 4 pz
Tischnummerständer, Satz 4 Stk
Support numéro de table, set 4 pcs
Soporte número de mesa, set 4 pz

| art. | Ø cm. | h. cm. | € |
|----------|-------|--------|-------|
| 42954-04 | 4 | 10 | 36,78 |



SS

Table number stand

Supporto numero tavola
Tischnummerständer
Support numéro de table
Soporte número de mesa

| art. | Ø cm. | h. cm. | € |
|----------|-------|--------|-------|
| 42954-18 | 7,5 | 18,5 | 17,69 |



SS

Card holder

Supporto targhetta
Kartenhalter
Porte-cartes
Portatargetas

| art. | dim. cm. | € |
|----------|----------|------|
| 42952-05 | 6x5x3 | 3,62 |



SS

Table sign, 2 pcs set

Targhetta tavola, set 2 pz
Tischaufsteller, Satz 2 Stk
Plaquette de table, set 2 pcs
Placa de mesa, set 2 pz

| art. | dim. cm. | € |
|----------|-----------|-------|
| 42951-57 | 5,5x5x3,5 | 12,16 |



SS

Table sign, 2 pcs set

Targhetta tavola, set 2 pz
Tischaufsteller, Satz 2 Stk
Plaque de table, set 2 pcs
Placa de mesa, set 2 pz

| art. | dim. cm. | € |
|----------|-----------|------|
| 42951-59 | 5,5x5x3,5 | 8,44 |



SS

Reception bell

Campanella reception
Rezeptionsklingel
Sonette de réception
Timbre recepción

| art. | Ø cm. | h. cm. | € |
|----------|-------|--------|------|
| 41390-00 | 8,5 | 6 | 6,53 |



Table bell

Campanella da tavola
Tischklingel
Sonette de table
Timbre de mesa

| art. | Ø cm. | h. cm. | € |
|----------|-------|--------|-------|
| 41391-08 | 8 | 15,5 | 17,29 |



W

Newspaper stick

Portagiornale
Zeitungshalter
Canne à journaux
Varilla portaperiodico

| art. | l. cm. | col. | € |
|----------|--------|------|-------|
| 48287-18 | 75 | ● | 21,31 |
| 48287-19 | 75 | ● | 25,83 |



SS

Ashtray

Posacenere
Aschenbecher
Cendrier
Cenicero

| art. | Ø cm. | € |
|----------|-------|-------|
| 48247-10 | 10 | 16,88 |



SS

Ashtray

Posacenere
Aschenbecher
Cendrier
Cenicero

| art. | Ø cm. | h. cm. | € |
|----------|-------|--------|-------|
| 48250-10 | 10 | 4,5 | 13,47 |
| 48250-12 | 12 | 4,5 | 14,77 |



~~SS~~

Ashtray, chrome plated

Posacenere, cromato
Drehaschenbecher, Metall verchromt
Cendrier, chromé
Cenicero, cromado

| art. | Ø cm. | h. cm. | € |
|----------|-------|--------|-------|
| 48249-13 | 13 | 10,5 | 15,78 |



NEW

~~SS~~

Ashtray, chrome plated

Posacenere, cromato
Drehaschenbecher, Metall verchromt
Cendrier, chromé
Cenicero, cromado

| art. | Ø cm. | h. cm. | € |
|----------|-------|--------|-------|
| 48249-10 | 9,5 | 11 | 17,19 |

Glass and metal. – Vetro e metallo.



NEW

~~SS~~

Ashtray, chrome plated

Posacenere, cromato
Aschenbecher, Metall verchromt
Cendrier, chromé
Cenicero, cromado

| art. | Ø cm. | h. cm. | col. | € |
|----------|-------|--------|------|-------|
| 48255-01 | 9,5 | 8 | ● | 14,67 |
| 48255-04 | 9,5 | 8 | ○ | 14,67 |

Glass and metal. – Vetro e metallo.



NEW

SS

~~SS~~

Ashtray with windcover

Posacenere coperchio antivento
Windaschenbecher
Cendrier couvercle anti-vent
Cenicero tapa antiviento

| art. | Ø cm. | h. cm. | € |
|----------|-------|--------|-------|
| 48249-12 | 12 | 5,5 | 15,38 |



MF

Ashtray, 3 pcs set

Posacenere, set 3 pz
Aschenbecher, 3 Stk
Cendrier, set 3 pièces
Cenicero, 3 pz

| art. | Ø cm. | h. cm. | col. | € |
|----------|-------|--------|------|------|
| 48251-03 | 8 | 3 | ● | 4,72 |



MF

Ashtray

Posacenere
Aschenbecher
Cendrier
Cenicero

| art. | Ø cm. | h. cm. | col. | € |
|----------|-------|--------|------|------|
| 48253B09 | 9,5 | 4,5 | ● | 4,72 |



MF

Ashtray

Posacenere
Aschenbecher
Cendrier
Cenicero

| art. | Ø cm. | h. cm. | col. | € |
|----------|-------|--------|------|------|
| 48252-10 | 10 | 4,0 | ○ | 8,44 |
| 48252-12 | 12 | 4,5 | ○ | 9,05 |



MF

Ashtray

Posacenere
Aschenbecher
Cendrier
Cenicero

| art. | Ø cm. | h. cm. | col. | € |
|----------|-------|--------|------|------|
| 48252B10 | 10 | 4,0 | ● | 8,44 |
| 48252B12 | 12 | 4,5 | ● | 9,05 |



Table cigar cutter

Tagliasigari da tavola
Zigarrenschneider
Coupe-cigares
Guillotina para puros

| art. | dim. cm. | € |
|----------|----------|------|
| 48244-07 | 9x4 | 9,25 |

Double blad. Assorted models.
Doppia lama. Modelli assortiti.



SS

Table cigar cutter

Tagliasigari da tavola
Zigarrenschneider
Coupe-cigares
Guillotina para puros

| art. | dim. cm. | € |
|----------|----------|-------|
| 48244-04 | 4x4 | 56,68 |



SS

Table cigar cutter

Tagliasigari da tavola
Zigarrenschneider
Coupe-cigares
Guillotina para puros

| art. | dim. cm. | € |
|----------|----------|-------|
| 48242-09 | 9x4 | 73,77 |



SS

Cigar scissors

Forbice sigari
Zigarrenscherer
Ciseaux à cigares
Cortador para puros

| art. | dim. cm. | € |
|----------|----------|-------|
| 48245-10 | 10x5 | 14,17 |



SS

Cigar ashtray

Portasigaro con piattino
Aschenbecher mit Zigarrenhalter
Cendrier à cigares
Cenicero para puros

| art. | Ø cm. | € |
|----------|-------|-------|
| 48241-14 | 14,5 | 80,60 |



PMMA

W

Cigar humidor

Vetrina sigari
Zigarren-Vitrine
Vitrine à cigares
Vitrina para puros

| art. | dim. cm. | € |
|----------|----------|--------|
| 48245-75 | 30x24x13 | 386,02 |

With an incorporated hygrometre a small humidifier and liquid. Plexiglass window, cedar wood interior with two removable dividers. Can contain between 50 and 70 cigars according to the cigar ring.

Dotato di igrometro incorporato e un piccolo umidificatore oltre al liquido. Finestra in plexiglass interno di cedro con due divisori removibili. Capienza da 50 a 75 sigari in relazione al ring del sigaro.

PEUGEOT MILLS MACINE



TABLE TOP
TAVOLA



MECHANISMS
MECCANISMI



PEPPER



SALT



WET SEA SALT



LONG PEPPER



CHILI PEPPER



NUTMEG



CINNAMON



FLAX SEED

PEPPER

Made of case-hardened steel for higher, more consistent output with fewer turns. Equipped with a helix-shaped double row of teeth that guide and hold the peppercorns for a perfect grind. The grind is essential for unlocking the full flavour of your pepper. To get the best out of your pepper grinding mechanism, we recommend to use peppercorns with a diameter of 6 mm or less. Black, white and dry green peppercorns can be ground in Peugeot pepper mills. The pink berries can be ground only if in a blend (max 15% pink) with one of these peppercorns. Dried coriander is also suitable for the pepper mechanism.

DRY SALT

The Peugeot salt mechanism is designed to grind cooking salt (rock salt). It is made of a special stainless steel that resists corrosion. Its shape is specifically adapted to transform dry salt crystals to a fine powder. To get the best out of your Peugeot salt grinding mechanism, you should use salt with a size of 4 mm max.

WET SEA SALT

For wet sea salt, a specially designed mechanism has been created because the natural consistency and moisture content do not allow the use of an ordinary salt mill. An innovative patented system enables a high-performance grind without blockage even with very humid or compressed salt. This specific mechanism is composed of 3 fins ensuring both resistance and constant output, and of a spiral that mixes the salt and guides it, ensuring a constant flow. Exclusive ceramic mechanism.

NUTMEG

The Peugeot nutmeg mill is equipped with a double stainless steel blade/grater and a strong claw which enables the nutmeg to be very finely ground.

CHILI PEPPER

The chili pepper mechanism is a Peugeot exclusive product. This patented model has a pre-cutting system and a mechanism that grinds dry chili pepper. Like the pepper grinder it has a patented treatment that protects the steel from corrosion while maintaining its sharpness and wear resistance.

PEPE

Realizzato in acciaio, beneficia di un trattamento che lo protegge dalla corrosione, conserva il potere tranciante e lo rende resistente all'usura. Dotato di una doppia fila di denti elicoidali che guidano i grani di pepe verso il basso. Trancia e non schiaccia i grani, per sprigionarne sottilmente sapore e profumo. Consigliamo di utilizzare grani di pepe con un diametro di 6 mm o meno. I grani di pepe neri, bianchi e verdi secchi possono essere macinati nei macinapepe Peugeot. Le bacche rosa possono essere macinate solo se in miscela (max 15% rosa). Il meccanismo del pepe è adatto anche al coriandolo essiccato.

SALE SECCO

Il meccanismo del sale è progettato per macinare il sale da cucina (sale grosso). È fatto di uno speciale acciaio inossidabile resistente alla corrosione. La sua forma è specificamente adattata per trasformare cristalli di sale secco in una polvere fine. Per un risultato ottimale si consiglia di usare sale con una dimensione di 4 mm max.

SALE MARINO UMIDO

Per il sale marino umido, è stato creato un meccanismo apposito. Un innovativo sistema brevettato consente una macinatura ad alte prestazioni senza ostruzioni anche con sale molto umido o compresso. Il meccanismo è composto da 3 alette che ne garantiscono sia la resistenza sia un rendimento costante, e di una spirale che mescola il sale e lo guida assicurandone un flusso costante. Meccanismo esclusivo in ceramica.

NOCE MOSCATA

La macina è dotata di una doppia lama per grattugiare in acciaio inox e di un robusto dischetto uncinato che permette di grattugiare l'intera noce molto finemente.

PEPERONCINO

Questo meccanismo è un prodotto esclusivo Peugeot. Il modello brevettato ha un sistema di pre-taglio e un meccanismo che permettono di macinare il peperoncino essiccato. Come il macinapepe, il meccanismo subisce un trattamento brevettato che protegge l'acciaio dalla corrosione pur mantenendo la sua affilatura e resistenza all'usura.





ADJUSTABLE GRINDING SYSTEM

For electric or manual mills.

Patented precision system that enables precise grind adjustment settings. 6 pre-defined levels of grind for pepper and 6 for salt. Rotate the ring at the base of the mill and select one of the positions, each corresponding to a specific grain.

REGOLAZIONE DELLA MACINA

Per macine manuali ed elettriche.

Sistema brevettato che permette una regolazione predefinita della macinatura. 6 Livelli per il pepe e 6 Livelli per il sale. Ruotare l'anello alla base della macina e selezionare una delle posizioni, ognuna corrisponde ad una determinata grana.



CLASSIC ADJUSTABLE SYSTEM

Thumbwheel grind adjustment on electric grinders is found below the grinding mechanism. Grind adjustment nut on manual mills, turn the nut. Clockwise to obtain a finger grind, counter-clockwise to obtain a coarser grind.

REGOLAZIONE CLASSICA

Negli apparecchi elettrici la rotella di regolazione si trova sotto il meccanismo di macinatura. Negli apparecchi manuali la regolazione si effettua ruotando il dado/pomolino. Ruotare in senso orario per ottenere una macinatura più fine, in senso antiorario per ottenere una macinatura più grossa.



PEPPER



SALT





W

PARIS ANTIQUE Pepper/salt mill

Macina pepe/sale
Pfeffer-/Salzmühle
Moulin à poivre/sel
Molinillo pimienta/sal

| art.-P | art.-S | h. cm. | € |
|----------|----------|--------|-------|
| 42749P18 | 42749S18 | 18 | 58,79 |
| 42749P22 | 42749S22 | 22 | 65,73 |

Beech wood antique. – Faggio anticato.



W

PARIS Pepper/salt mill

Macina pepe/sale
Pfeffer-/Salzmühle
Moulin à poivre/sel
Molinillo pimienta/sal

| art.-P | art.-S | h. cm. | € |
|----------|----------|--------|-------|
| 42746P12 | - | 12 | 32,26 |
| 42746P18 | 42746S18 | 18 | 38,19 |
| 42746P22 | 42746S22 | 22 | 42,11 |
| 42746P30 | 42746S30 | 30 | 57,89 |

Beech wood, chocolate. – Faggio cioccolato.



W

PARIS Pepper/salt mill

Macina pepe/sale
Pfeffer-/Salzmühle
Moulin à poivre/sel
Molinillo pimienta/sal

| art.-P | art.-S | h. cm. | € |
|----------|--------|--------|--------|
| 42746P40 | - | 40 | 78,39 |
| 42746P50 | - | 50 | 142,31 |
| 42746P80 | - | 80 | 293,56 |

Beech wood, chocolate. – Faggio cioccolato.



W

PARIS Pepper/salt mill

Macina pepe/sale
Pfeffer-/Salzmühle
Moulin à poivre/sel
Molinillo pimienta/sal

| art.-P | art.-S | h. cm. | € |
|----------|----------|--------|-------|
| 42747P12 | 42747S12 | 12 | 33,27 |
| 42747P18 | 42747S18 | 18 | 42,11 |

Beech wood, black lacquered. – Faggio laccato nero.



W

PARIS OLIVE Pepper/salt mill

Macina pepe/sale
Pfeffer-/Salzmühle
Moulin à poivre/sel
Molinillo pimienta/sal

| art.-P | art.-S | h. cm. | € |
|----------|----------|--------|-------|
| 42718P18 | 42718S18 | 18 | 78,39 |
| 42718P22 | 42718S22 | 22 | 88,24 |

Olive wood. – Ulivo.



W

SS

U
SELECT
MOÛTURE SUR MESURE

PARIS ICÔNE Pepper/salt mill

Macina pepe/sale
Pfeffer-/Salzmühle
Moulin à poivre/sel
Molinillo pimienta/sal

| art.-P | art.-S | h. cm. | € |
|----------|----------|--------|-------|
| 42688P18 | 42688S18 | 18 | 58,79 |
| 42688P22 | 42688S22 | 22 | 68,64 |
| 42688P30 | 42688S30 | 30 | 83,42 |

Laquered black. – Laccato nero.



NEW

W

U
SELECT
MOÛTURE SUR MESURE

PARIS Pepper/salt mill

Macina pepe/sale
Pfeffer-/Salzmühle
Moulin à poivre/sel
Molinillo pimienta/sal

| art.-P | art.-S | h. cm. | € |
|----------|----------|--------|--------|
| 42691P12 | 42691S12 | 12 | 41,10 |
| 42691P18 | 42691S18 | 18 | 51,96 |
| 42691P22 | 42691S22 | 22 | 60,80 |
| 42691P30 | 42691S30 | 30 | 78,39 |
| 42691P40 | - | 40 | 111,96 |

Beech wood, black satin. – Faggio, nero satinato.





PARIS Pepper/salt mill

Macina pepe/sale
Pfeffer-/Salzmühle
Moulin à poivre/sel
Molinillo pimienta/sal

| art.-P | art.-S | h. cm. | € |
|----------|----------|--------|-------|
| 42665P12 | 42665S12 | 12 | 36,28 |
| 42665P18 | 42665S18 | 18 | 44,12 |
| 42665P22 | 42665S22 | 22 | 53,87 |
| 42665P30 | 42665S30 | 30 | 68,64 |
| 42665P40 | 42665S40 | 40 | 93,16 |

Beech wood, natural. – Faggio naturale.



PARIS Pepper/salt mill

Macina pepe/sale
Pfeffer-/Salzmühle
Moulin à poivre/sel
Molinillo pimienta/sal

| art.-P | art.-S | h. cm. | € |
|----------|----------|--------|-------|
| 42666P12 | 42666S12 | 12 | 36,28 |
| 42666P18 | 42666S18 | 18 | 44,12 |
| 42666P22 | 42666S22 | 22 | 53,87 |
| 42666P27 | 42666S27 | 27 | 58,79 |
| 42666P30 | 42666S30 | 30 | 68,64 |
| 42666P40 | 42666S40 | 40 | 93,16 |

Beech wood, chocolate. – Faggio cioccolato.

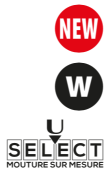

PARIS Pepper/salt mill

Macina pepe/sale
Pfeffer-/Salzmühle
Moulin à poivre/sel
Molinillo pimienta/sal

| art.-P | art.-S | h. cm. | € |
|----------|----------|--------|--------|
| 42694P12 | 42694S12 | 12 | 41,10 |
| 42694P18 | 42694S18 | 18 | 51,96 |
| 42694P22 | 42694S22 | 22 | 60,80 |
| 42694P30 | 42694S30 | 30 | 78,49 |
| 42694P40 | - | 40 | 111,96 |

Beech wood, red passion lacquered.
Faggio laccato red passion.



PARIS GRAPHITE Pepper/salt mill

Macina pepe/sale
Pfeffer-/Salzmühle
Moulin à poivre/sel
Molinillo pimienta/sal

| art.-P | art.-S | h. cm. | € |
|----------|----------|--------|-------|
| 42721P12 | 42721S12 | 12 | 36,28 |
| 42721P18 | 42721S18 | 18 | 44,12 |
| 42721P22 | 42721S22 | 22 | 53,87 |
| 42721P27 | 42721S27 | 27 | 58,79 |
| 42721P30 | 42721S30 | 30 | 68,64 |
| 42721P40 | - | 40 | 93,16 |

Beech wood graphite. – Faggio grafite.



PARIS Pepper/salt mill

Macina pepe/sale
Pfeffer-/Salzmühle
Moulin à poivre/sel
Molinillo pimienta/sal

| art.-P | art.-S | h. cm. | € |
|----------|----------|--------|-------|
| 42667P12 | 42667S12 | 12 | 41,10 |
| 42667P18 | 42667S18 | 18 | 51,96 |
| 42667P22 | 42667S22 | 22 | 60,80 |
| 42667P30 | 42667S30 | 30 | 78,39 |

Beech wood, black lacquered.
Faggio laccato nero.



PARIS Pepper/salt mill

Macina pepe/sale
Pfeffer-/Salzmühle
Moulin à poivre/sel
Molinillo pimienta/sal

| art.-P | art.-S | h. cm. | € |
|----------|----------|--------|--------|
| 42664P12 | 42664S12 | 12 | 41,10 |
| 42664P18 | 42664S18 | 18 | 51,96 |
| 42664P22 | 42664S22 | 22 | 60,80 |
| 42664P30 | 42664S30 | 30 | 78,39 |
| 42664P40 | - | 40 | 111,96 |

Beech wood, white lacquered.
Faggio laccato bianco.

Paris Ramma

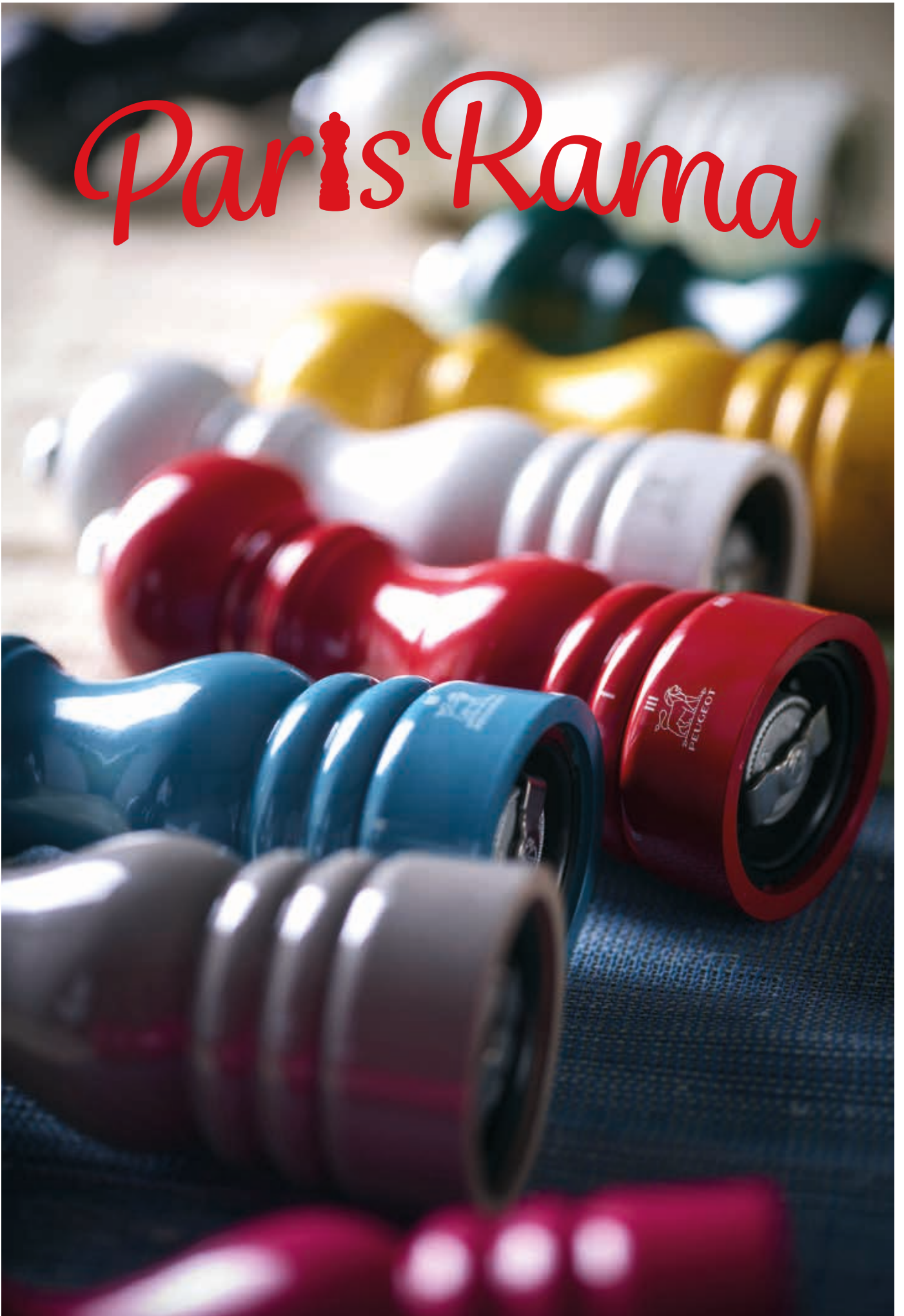



NEW

W

SELECT
MOULIN SUR MESURE

PARISRAMA Pepper/salt mill

Macina pepe/sale
Pfeffer-/Salzmühle
Moulin à poivre/sel
Molinillo pimienta/sal

| art.-P | art.-S | h. cm. | € |
|----------|----------|--------|-------|
| 42694P13 | 42694S13 | 18 | 51,96 |

Beech wood, jaune safran lacquered.
Faggio laccato jaune safran.



NEW

W

SELECT
MOULIN SUR MESURE

PARISRAMA Pepper/salt mill

Macina pepe/sale
Pfeffer-/Salzmühle
Moulin à poivre/sel
Molinillo pimienta/sal

| art.-P | art.-S | h. cm. | € |
|----------|----------|--------|-------|
| 42694P09 | 42694S09 | 18 | 51,96 |

Beech wood, vert foret lacquered.
Faggio laccato vert foret.



NEW

W

SELECT
MOULIN SUR MESURE

PARISRAMA Pepper mill

Macina pepe
Pfeffermühle
Moulin à poivre
Molinillo pimienta

| art. | h. cm. | € |
|----------|--------|-------|
| 42694P05 | 18 | 51,96 |

Beech wood, rose bonbon lacquered.
Faggio laccato rose bonbon.



NEW

W

SELECT
MOULIN SUR MESURE

PARISRAMA Salt mill

Macina sale
Salzmühle
Moulin à sel
Molinillo sal

| art. | h. cm. | € |
|----------|--------|-------|
| 42694S10 | 18 | 51,96 |

Beech wood, ivoire lacquered.
Faggio laccato ivoire.



NEW

W

SELECT
MOULIN SUR MESURE

PARISRAMA Salt mill

Macina sale
Salzmühle
Moulin à sel
Molinillo sal

| art. | h. cm. | € |
|----------|--------|-------|
| 42694S07 | 18 | 51,96 |

Beech wood, gris perle lacquered.
Faggio laccato gris perle.



NEW

W

SELECT
MOULIN SUR MESURE

PARISRAMA Pepper mill

Macina pepe
Pfeffermühle
Moulin à poivre
Molinillo pimienta

| art. | h. cm. | € |
|----------|--------|-------|
| 42694P11 | 18 | 51,96 |

Beech wood, gris taupe lacquered.
Faggio laccato gris taupe.



PARISRAMA Pepper/salt mill

Macina pepe/sale
Pfeffer-/Salzmühle
Moulin à poivre/sel
Molinillo pimienta/sal

| art.-P | art.-S | h. cm. | € |
|----------|----------|--------|-------|
| 42694P18 | 42694S18 | 18 | 51,96 |

Beech wood, red passion lacquered.
Faggio laccato red passion.



PARISRAMA Pepper mill

Macina pepe
Pfeffermühle
Moulin à poivre
Molinillo pimienta

| art. | h. cm. | € |
|----------|--------|-------|
| 42694P06 | 18 | 51,96 |

Beech wood, ardoise lacquered.
Faggio laccato ardoise.



PARISRAMA Pepper mill

Macina pepe
Pfeffermühle
Moulin à poivre
Molinillo pimienta

| art. | h. cm. | € |
|----------|--------|-------|
| 42694P04 | 18 | 51,96 |

Beech wood, aubergine lacquered.
Faggio laccato aubergine.



PARISRAMA Pepper/salt mill

Macina pepe/sale
Pfeffer-/Salzmühle
Moulin à poivre/sel
Molinillo pimienta/sal

| art.-P | art.-S | h. cm. | € |
|----------|----------|--------|-------|
| 42694P02 | 42694S02 | 18 | 51,96 |

Beech wood, bleu pacifique lacquered.
Faggio laccato bleu pacifique.



NATURE & NATURE BLACK

UPCYCLING PROCESS / PROCESSO DI RIUTILIZZO

SORTING
SELEZIONE



DISCARDED WOOD

Knots and differences in grain colour are inherent in the tree's growth and represent the very nature of the wood.

LEGNO SCARTATO

Nodi e differenze di grana di colore sono intrinseche nella crescita dell'albero e rappresentano la vera natura del legno.

BLASTING
SABBIATURA



NEW LEASE OF LIFE

The sandblasting process gives the mills a strong look with their original irregular finish.

NUOVA VITA

Il processo di sabbiatura con la finitura irregolare e originale conferisce alle macine un carattere forte.

VARNISHING
VERNICIATURA

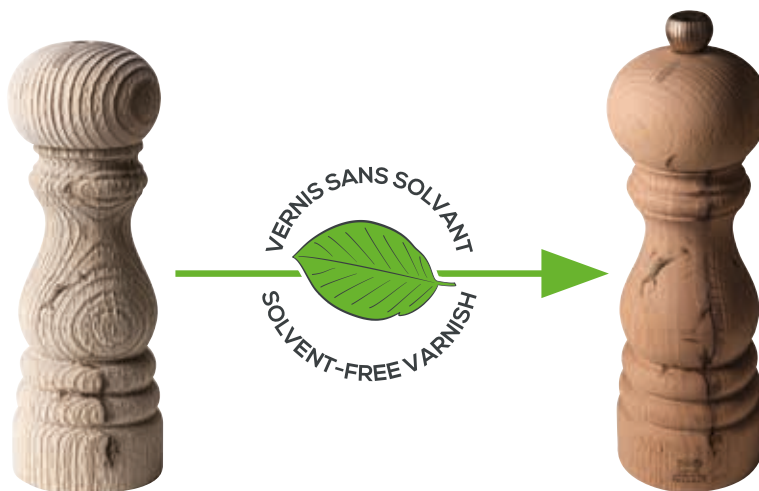

Protection with a solvent-free varnish for everyday use while locking in the wood's natural character.

Una vernice senza solventi rende le macine idonee all'uso quotidiano, pur mantenendo il carattere naturale del legno.

This collection is created from wooden pieces that are discarded at different stages of our manufacturing process (after turning, or after being painted). In order to recycle these pieces and give them a new lease of life, Peugeot carries out a mechanical sandblasting. This is what gives these mills their unusual and irregular texture, endowing them with such a striking organic look. A solvent-free varnish is then applied to protect the wood ensuring its longevity and resistance for lasting daily use. NATURE BLACK comes to life from pieces of wood recycled after painting in the famous chocolate finish. The sandblasting process creates a unique relief that is enhanced by applying a solvent-free matte black paint. The paint together with the texture create an interaction of light with opaque and glossy reflections, instilling its uniqueness in the millstone. A unique play of light, a mix of texture and color.

La collezione NATURE è creata con pezzi di legno che venivano scartati nelle diverse fasi del processo produttivo (dopo la tornitura o dopo la verniciatura). Riprendono ora vita mettendo in mostra le qualità intrinseche del legno. Il processo di sabbiatura con la finitura irregolare e originale conferisce alle macine un carattere forte e dal sorprendente aspetto organico. Ogni pezzo diventa singolare e unico. Una vernice senza solventi protegge il legno garantendone la longevità e la resistenza all'uso quotidiano. NATURE BLACK prende vita da pezzi di legno riutilizzati dopo la verniciatura nella famosa finitura cioccolato. Il processo di sabbiatura crea un rilievo unico che viene esaltato mediante l'applicazione di una vernice nera opaca priva di solventi. La vernice unitamente alla texture, creano un'interazione di luce con riflessi opachi e lucidi instillando nella macina la sua singolarità. Un gioco di luci unico, un mix di texture e colore.



BISTRO NATURE Pepper/salt mill

Macina pepe/sale
Pfeffer-/Salzmühle
Moulin à poivre/sel
Molinillo pimienta/sal

| art-P | art-S | h. cm. | € |
|----------|----------|--------|-------|
| 42627P10 | 42627S10 | 10 | 29,35 |



BISTRO NATURE BLACK Pepper/salt mill

Macina pepe/sale
Pfeffer-/Salzmühle
Moulin à poivre/sel
Molinillo pimienta/sal

| art-P | art-S | h. cm. | € |
|----------|----------|--------|-------|
| 42628P10 | 42628S10 | 10 | 29,35 |



PARIS NATURE Pepper/salt mill

Macina pepe/sale
Pfeffer-/Salzmühle
Moulin à poivre/sel
Molinillo pimienta/sal

| art-P | art-S | h. cm. | € |
|----------|----------|--------|-------|
| 42627P12 | 42627S12 | 12 | 33,27 |
| 42627P18 | 42627S18 | 18 | 42,11 |
| 42627P22 | 42627S22 | 22 | 47,03 |
| 42627P30 | 42627S30 | 30 | 61,81 |
| 42627P40 | - | 40 | 83,42 |



PARIS NATURE BLACK Pepper/salt mill

Macina pepe/sale
Pfeffer-/Salzmühle
Moulin à poivre/sel
Molinillo pimienta/sal

| art-P | art-S | h. cm. | € |
|----------|----------|--------|-------|
| 42628P12 | 42628S12 | 12 | 33,27 |
| 42628P18 | 42628S18 | 18 | 42,11 |
| 42628P22 | 42628S22 | 22 | 47,03 |
| 42628P30 | 42628S30 | 30 | 61,81 |
| 42628P40 | - | 40 | 83,42 |







NEW

SS

SELECT
MOULIN SUR MESURE

PARIS CHEF COPPER Pepper/salt mill

Macina pepe/sale
Pfeffer-/Salzmühle
Moulin à poivre/sel
Molinillo pimienta/sal

| art.-P | art.-S | h. cm. | € |
|----------|----------|--------|-------|
| 42695P22 | 42695S22 | 22 | 88,24 |

Electroplated copper finish.
Finitura rame elettrolitica.



NEW

SS

SELECT
MOULIN SUR MESURE

PARIS CHEF CARBONE Pepper/salt mill

Macina pepe/sale
Pfeffer-/Salzmühle
Moulin à poivre/sel
Molinillo pimienta/sal

| art.-P | art.-S | h. cm. | € |
|----------|----------|--------|-------|
| 42696P22 | 42696S22 | 22 | 88,24 |

Special anthracite paint finish.
Verniciatura speciale antracite.



SS

SELECT
MOULIN SUR MESURE

PARIS CHEF Pepper/salt mill

Macina pepe/sale
Pfeffer-/Salzmühle
Moulin à poivre/sel
Molinillo pimienta/sal

| art.-P | art.-S | h. cm. | € |
|----------|----------|--------|-------|
| 42674P18 | 42674S18 | 18 | 66,63 |
| 42674P22 | 42674S22 | 22 | 71,56 |
| 42674P30 | 42674S30 | 30 | 88,24 |



SS

BISTRO CHEF Pepper/salt mill

Macina pepe/sale
Pfeffer-/Salzmühle
Moulin à poivre/sel
Molinillo pimienta/sal

| art.-P | art.-S | h. cm. | € |
|----------|----------|--------|-------|
| 42624P10 | 42624S10 | 10 | 42,11 |



W

BISTRO Pepper/salt mill

Macina pepe/sale
Pfeffer-/Salzmühle
Moulin à poivre/sel
Molinillo pimienta/sal

| art.-P | art.-S | h. cm. | € |
|----------|----------|--------|-------|
| 42701-10 | 42703-10 | 10 | 26,43 |

Beech wood, natural. – Faggio naturale.



W

BISTRO Pepper/salt mill

Macina pepe/sale
Pfeffer-/Salzmühle
Moulin à poivre/sel
Molinillo pimienta/sal

| art.-P | art.-S | h. cm. | € |
|----------|----------|--------|-------|
| 42701P10 | 42703S10 | 10 | 29,35 |

Beech wood, white matt. – Faggio bianco opaco.





W

BISTRO Pepper/salt mill

Macina pepe/sale
Pfeffer-/Salzmühle
Moulin à poivre/sel
Molinillo pimienta/sal

| art.-P | art.-S | h. cm. | € |
|----------|----------|--------|-------|
| 42702-10 | 42704-10 | 10 | 26,43 |

Beech wood, chocolate. – Faggio cioccolato.



W

BISTRO Pepper/salt mill

Macina pepe/sale
Pfeffer-/Salzmühle
Moulin à poivre/sel
Molinillo pimienta/sal

| art.-P | art.-S | h. cm. | € |
|----------|----------|--------|-------|
| 42702P10 | 42704S10 | 10 | 29,35 |

Beech wood, black matt. – Faggio nero opaco.



W

BISTRO ANTIQUE Pepper/salt mill

Macina pepe/sale
Pfeffer-/Salzmühle
Moulin à poivre/sel
Molinillo pimienta/sal

| art.-P | art.-S | h. cm. | € |
|----------|----------|--------|-------|
| 42705P10 | 42705S10 | 10 | 42,11 |

Beech wood antique. – Faggio anticato.



W

BISTRO GRAPHITE Pepper/salt mill

Macina pepe/sale
Pfeffer-/Salzmühle
Moulin à poivre/sel
Molinillo pimienta/sal

| art.-P | art.-S | h. cm. | € |
|----------|----------|--------|-------|
| 42713P10 | 42713S10 | 10 | 29,35 |

Beech wood graphite. – Faggio grafite.



W

BISTRO OLIVE Pepper/salt mill

Macina pepe/sale
Pfeffer-/Salzmühle
Moulin à poivre/sel
Molinillo pimienta/sal

| art.-P | art.-S | h. cm. | € |
|----------|----------|--------|-------|
| 42714P10 | 42714S10 | 10 | 51,96 |

Olive wood. – Ulivo.



NEW

AY

BISTRO Pepper/salt mill

Macina pepe/sale
Pfeffer-/Salzmühle
Moulin à poivre/sel
Molinillo pimienta/sal

| art.-P | art.-S | h. cm. | € |
|----------|----------|--------|-------|
| 42706P10 | 42706S10 | 10 | 29,35 |



W

HOSTELLERIE Pepper mill

Macina pepe
Pfeffermühle
Moulin à poivre
Molinillo pimienta

| art. | h. cm. | col. | € |
|----------|--------|------|-------|
| 42741-22 | 22 | ● | 39,20 |
| 42742-22 | 22 | ● | 39,20 |

Natural & chocolate. – Naturale & cioccolato.



W

SS

ROYAN Pepper/salt mill

Macina pepe/sale
Pfeffer-/Salzmühle
Moulin à poivre/sel
Molinillo pimienta/sal

| art.-P | art.-S | h. cm. | € |
|----------|----------|--------|-------|
| 42677P14 | 42677S14 | 14 | 55,88 |

Beech wood. Metallic finish that reveals the wood's grains. – Faggio. Finitura metallica che rivela le venature del legno.



NEW
W

TAHITI DUO WATER Pepper/salt mill

Macina pepe/sale
Pfeffer-/Salzmühle
Moulin à poivre/sel
Molinillo pimienta/sal

| art. | h. cm. | € |
|----------|--------|-------|
| 42632-01 | 15 | 67,03 |



NEW
W

TAHITI DUO AIR Pepper/salt mill

Macina pepe/sale
Pfeffer-/Salzmühle
Moulin à poivre/sel
Molinillo pimienta/sal

| art. | h. cm. | € |
|----------|--------|-------|
| 42632-02 | 15 | 67,03 |



NEW
W

TAHITI DUO FIRE Pepper/salt mill

Macina pepe/sale
Pfeffer-/Salzmühle
Moulin à poivre/sel
Molinillo pimienta/sal

| art. | h. cm. | € |
|----------|--------|-------|
| 42632-03 | 15 | 67,03 |



NEW
W

TAHITI DUO EARTH Pepper/salt mill

Macina pepe/sale
Pfeffer-/Salzmühle
Moulin à poivre/sel
Molinillo pimienta/sal

| art. | h. cm. | € |
|----------|--------|-------|
| 42632-04 | 15 | 67,03 |

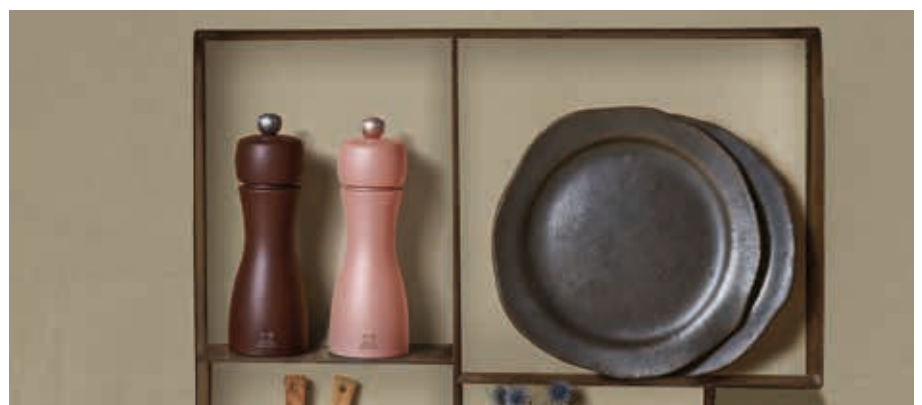

Bistrotoranna





BISTRORAMA Pepper/salt mill

Macina pepe/sale
Pfeffer-/Salzmühle
Moulin à poivre/sel
Molinillo pimienta/sal

| art-P | art-S | h. cm. | U. Pack | € |
|----------|----------|--------|---------|-------|
| 42630P01 | 42630S01 | 10 | 3 | 29,35 |

Red passion.



BISTRORAMA Pepper/salt mill

Macina pepe/sale
Pfeffer-/Salzmühle
Moulin à poivre/sel
Molinillo pimienta/sal

| art-P | art-S | h. cm. | U. Pack | € |
|----------|----------|--------|---------|-------|
| 42630P02 | 42630S02 | 10 | 3 | 29,35 |

Pacific blue.



BISTRORAMA Pepper/salt mill

Macina pepe/sale
Pfeffer-/Salzmühle
Moulin à poivre/sel
Molinillo pimienta/sal

| art-P | art-S | h. cm. | U. Pack | € |
|----------|----------|--------|---------|-------|
| 42630P03 | 42630S03 | 10 | 3 | 29,35 |

Pistachio.



BISTRORAMA Pepper/salt mill

Macina pepe/sale
Pfeffer-/Salzmühle
Moulin à poivre/sel
Molinillo pimienta/sal

| art-P | art-S | h. cm. | U. Pack | € |
|----------|----------|--------|---------|-------|
| 42630P04 | 42630S04 | 10 | 3 | 29,35 |

Eggplant.



BISTRORAMA Pepper/salt mill

Macina pepe/sale
Pfeffer-/Salzmühle
Moulin à poivre/sel
Molinillo pimienta/sal

| art-P | art-S | h. cm. | U. Pack | € |
|----------|----------|--------|---------|-------|
| 42630P05 | 42630S05 | 10 | 3 | 29,35 |

Candy rose.



BISTRORAMA Pepper/salt mill

Macina pepe/sale
Pfeffer-/Salzmühle
Moulin à poivre/sel
Molinillo pimienta/sal

| art-P | art-S | h. cm. | U. Pack | € |
|----------|----------|--------|---------|-------|
| 42630P06 | 42630S06 | 10 | 3 | 29,35 |

Slate lacquer.



BISTRORAMA Pepper/salt mill

Macina pepe/sale
Pfeffer-/Salzmühle
Moulin à poivre/sel
Molinillo pimienta/sal

| art-P | art-S | h. cm. | U. Pack | € |
|----------|----------|--------|---------|-------|
| 42630P07 | 42630S07 | 10 | 3 | 29,35 |

Ivory lacquer.





NEW

W

BISTRORAMA Pepper/salt mill

Macina pepe/sale
Pfeffer-/Salzmühle
Moulin à poivre/sel
Molinillo pimienta/sal

| art.-P | art.-S | h. cm. | U. Pack | € |
|----------|----------|--------|---------|-------|
| 42630P08 | 42630S08 | 10 | 3 | 29,35 |

Terracotta.



NEW

W

BISTRORAMA Pepper/salt mill

Macina pepe/sale
Pfeffer-/Salzmühle
Moulin à poivre/sel
Molinillo pimienta/sal

| art.-P | art.-S | h. cm. | U. Pack | € |
|----------|----------|--------|---------|-------|
| 42630P09 | 42630S09 | 10 | 3 | 29,35 |

Green forest.



NEW

W

BISTRORAMA Pepper/salt mill

Macina pepe/sale
Pfeffer-/Salzmühle
Moulin à poivre/sel
Molinillo pimienta/sal

| art.-P | art.-S | h. cm. | U. Pack | € |
|----------|----------|--------|---------|-------|
| 42630P10 | 42630S10 | 10 | 3 | 29,35 |

Pearl grey.



NEW

W

BISTRORAMA Pepper/salt mill

Macina pepe/sale
Pfeffer-/Salzmühle
Moulin à poivre/sel
Molinillo pimienta/sal

| art.-P | art.-S | h. cm. | U. Pack | € |
|----------|----------|--------|---------|-------|
| 42630P11 | 42630S11 | 10 | 3 | 29,35 |

Grey.



NEW

W

BISTRORAMA Pepper/salt mill

Macina pepe/sale
Pfeffer-/Salzmühle
Moulin à poivre/sel
Molinillo pimienta/sal

| art.-P | art.-S | h. cm. | U. Pack | € |
|----------|----------|--------|---------|-------|
| 42630P12 | 42630S12 | 10 | 3 | 29,35 |

Black lacquer.



NEW

W

BISTRORAMA Pepper/salt mill

Macina pepe/sale
Pfeffer-/Salzmühle
Moulin à poivre/sel
Molinillo pimienta/sal

| art.-P | art.-S | h. cm. | U. Pack | € |
|----------|----------|--------|---------|-------|
| 42630P13 | 42630S13 | 10 | 3 | 29,35 |

Yellow saffron.



**TABLE TOP TAVOLA
PEUGEOT MILLS MACINE**



W
SS

FIDJI GRAPHITE Pepper/salt mill

Macina pepe/sale
Pfeffer-/Salzmühle
Moulin à poivre/sel
Molinillo pimienta/sal

| art.-P | art.-S | h. cm. | € |
|----------|----------|--------|-------|
| 42655P15 | 42655S15 | 15 | 48,04 |

Beech wood graphite. – Faggio grafite.



W
SS

FIDJI OLIVE Pepper/salt mill

Macina pepe/sale
Pfeffer-/Salzmühle
Moulin à poivre/sel
Molinillo pimienta/sal

| art.-P | art.-S | h. cm. | € |
|----------|----------|--------|-------|
| 42676P15 | 42676S15 | 15 | 85,32 |
| 42676P20 | 42676S20 | 20 | 97,18 |

Olive wood. – Ulivo.



W
SS

FIDJI Pepper/salt mill

Macina pepe/sale
Pfeffer-/Salzmühle
Moulin à poivre/sel
Molinillo pimienta/sal

| art.-P | art.-S | h. cm. | € |
|----------|----------|--------|-------|
| 42767P12 | 42767S12 | 12 | 42,11 |
| 42767P15 | 42767S15 | 15 | 51,96 |
| 42767P20 | 42767S20 | 20 | 66,63 |

Beech wood, black matt. – Faggio nero opaco.



NEW

LINE Pepper/salt mill

Macina pepe/sale
Pfeffer-/Salzmühle
Moulin à poivre/sel
Molinillo pimienta/sal

| art.-P | art.-S | h. cm. | € |
|----------|----------|--------|-------|
| 42625P12 | 42625S12 | 12 | 44,12 |
| 42625P18 | 42625S18 | 18 | 49,04 |

**Beech wood and aluminum.
Legno di faggio e alluminio.**



NEW

LINE Pepper/salt mill

Macina pepe/sale
Pfeffer-/Salzmühle
Moulin à poivre/sel
Molinillo pimienta/sal

| art.-P | art.-S | h. cm. | € |
|----------|----------|--------|-------|
| 42626P12 | 42626S12 | 12 | 44,12 |
| 42626P18 | 42626S18 | 18 | 49,04 |

**Beech wood and aluminum.
Legno di faggio e alluminio.**



BALI FONTE Pepper mill

Macina pepe
Pfeffermühle
Moulin à poivre
Molinillo pimienta

| art. | h. cm. | col. | € |
|----------|--------|------|-------|
| 42620P03 | 8 | ● | 65,73 |
| 42620P01 | 8 | ● | 65,73 |
| 42620P02 | 8 | ● | 65,73 |

Cast iron. – Ghisa.





NEW

BALI pepper mill/salt dispenser

Macina pepe/Portasale
Pfeffermühle/Salzbehälter
Moulin à poivre/porte-sel
Molinillo pimienta/salero

| art. | h. cm. | col. | € |
|----------|--------|------|--------|
| 42620-02 | 8 | ● | 127,64 |

Cast iron. Bamboo tray. – Ghisa. Vassosio bambù.



NEW

BALI FONTE Pepper mill

Macina pepe
Pfeffermühle
Moulin à poivre
Molinillo pimienta

| art. | h. cm. | col. | € |
|----------|--------|------|-------|
| 42620P05 | 8 | ● | 65,73 |



NEW

BALI FONTE Pepper mill

Macina pepe
Pfeffermühle
Moulin à poivre
Molinillo pimienta

| art. | h. cm. | col. | € |
|----------|--------|------|-------|
| 42620P06 | 8 | ● | 65,73 |



W

BAYA Pepper/salt mill

Macina pepe/sale
Pfeffer-/Salzmühle
Moulin à poivre/sel
Molinillo pimienta/sal

| art.-P | art.-S | h. cm. | € |
|----------|----------|--------|-------|
| 42684P08 | 42684S08 | 8 | 39,20 |

Chocolate & natural. – Cioccolato & naturale.



ABS

AY

BALI Pepper mill

Macina pepe
Pfeffermühle
Moulin à poivre
Molinillo pimienta

| art. | h. cm. | col. | € |
|----------|--------|------|-------|
| 42661-03 | 8 | ● | 37,19 |



ABS

AY

BALI Salt mill

Macina sale
Salzmühle
Moulin à sel
Molinillo sal

| art. | h. cm. | col. | € |
|----------|--------|------|-------|
| 42661-06 | 8 | ○ | 37,19 |



AY
SS

SELECT
MOULIN SUR MESURE

DAMAN Pepper/salt mill

Macina pepe/sale
Pfeffer-/Salzmühle
Moulin à poivre/sel
Molinillo pimienta/sal

| art.-P | art.-S | h. cm. | € |
|----------|----------|--------|-------|
| 42764P16 | 42764S16 | 16 | 63,72 |
| 42764P21 | 42764S21 | 21 | 68,64 |



W
SS

SELECT
MOULIN SUR MESURE

MADRAS Pepper/salt mill

Macina pepe/sale
Pfeffer-/Salzmühle
Moulin à poivre/sel
Molinillo pimienta/sal

| art.-P | art.-S | h. cm. | € |
|----------|----------|--------|-------|
| 42705P16 | 42705S16 | 16 | 71,56 |
| 42705P21 | 42705S21 | 21 | 76,48 |

Beech wood chocolate. – Faggio cioccolato.



W
SS

MADRAS GRAPHITE Pepper/salt mill

Macina pepe/sale
Pfeffer-/Salzmühle
Moulin à poivre/sel
Molinillo pimienta/sal

| art.-P | art.-S | h. cm. | € |
|----------|----------|--------|-------|
| 42717P16 | 42717S16 | 16 | 71,56 |

Beech wood graphite. – Faggio grafite.



AY

CHAUMONT Pepper/salt mill

Macina pepe/sale
Pfeffer-/Salzmühle
Moulin à poivre/sel
Molinillo pimienta/sal

| art.-P | art.-S | h. cm. | € |
|----------|----------|--------|-------|
| 42798P11 | 42798S11 | 11 | 39,20 |



AY

VITTEL Pepper/salt mill

Macina pepe/sale
Pfeffer-/Salzmühle
Moulin à poivre/sel
Molinillo pimienta/sal

| art.-P | art.-S | h. cm. | € |
|----------|----------|--------|-------|
| 42796P16 | 42796S16 | 16 | 44,12 |
| 42796P23 | 42796S23 | 23 | 51,96 |



AY

NANCY Wet sea salt mill

Macina per sale umido
Mühle für Feuchtes Meersalz
Moulin à sel humide
Molinillo sal húmeda

| art. | h. cm. | € |
|----------|--------|-------|
| 42728S18 | 18 | 44,12 |



AY

NANCY Pepper/salt mill

Macina pepe/sale
Pfeffer-/Salzmühle
Moulin à poivre/sel
Molinillo pimienta/sal

| art.-P | art.-S | h. cm. | € |
|----------|----------|--------|-------|
| 42727-09 | 42728-09 | 9 | 29,35 |
| 42727-12 | 42728-12 | 12 | 36,28 |
| 42727-18 | 42728-18 | 18 | 39,20 |





AY

NANCY Pepper/salt mill

Macina pepe/sale
Pfeffer-/Salzmühle
Moulin à poivre/sel
Molinillo pimienta/sal

| art.-P | art.-S | h. cm. | € |
|----------|----------|--------|-------|
| 42727-22 | 42728-22 | 22 | 44,12 |
| 42727-30 | 42728-30 | 30 | 68,64 |
| 42727-38 | 42728-38 | 38 | 97,18 |



AY

W

OLERON Wet sea salt mill

Macina per sale umido
Mühle für Feuchtes Meersalz
Moulin à sel humide
Molinillo sal húmeda

| art. | h. cm. | € |
|----------|--------|-------|
| 42670N14 | 14 | 47,03 |

Beech wood. – Faggio.



AY

W

OLERON Wet sea salt mill

Macina per sale umido
Mühle für Feuchtes Meersalz
Moulin à sel humide
Molinillo sal húmeda

| art. | h. cm. | € |
|----------|--------|-------|
| 42670B14 | 14 | 47,03 |

Beech wood. – Faggio.



AY

MOLENE Wet sea salt mill

Macina per sale umido
Mühle für Feuchtes Meersalz
Moulin à sel humide
Molinillo sal húmeda

| art. | h. cm. | € |
|----------|--------|-------|
| 42670W14 | 14 | 44,12 |

White. – Bianco.



AY

SS

OSLO Wet sea salt mill

Macina per sale umido
Mühle für Feuchtes Meersalz
Moulin à sel humide
Molinillo sal húmeda

| art. | h. cm. | € |
|----------|--------|-------|
| 42678W14 | 14 | 42,11 |



AY

SS

OSLO Pepper/salt mill

Macina pepe/sale
Pfeffer-/Salzmühle
Moulin à poivre/sel
Molinillo pimienta/sal

| art.-P | art.-S | h. cm. | € |
|----------|----------|--------|-------|
| 42678P14 | 42678S14 | 14 | 37,19 |



AY

W

OSLO GRAPHITE Pepper/salt mill

Macina pepe/sale
Pfeffer-/Salzmühle
Moulin à poivre/sel
Molinillo pimienta/sal

| art.-P | art.-S | h. cm. | € |
|----------|----------|--------|-------|
| 42679P12 | 42679S12 | 12 | 36,28 |

Beech wood graphite. – Faggio grafite.





AY
W

OLERON Pepper/salt mill

Macina pepe/sale
Pfeffer-/Salzmühle
Moulin à poivre/sel
Molinillo pimienta/sal

| art.-P | art.-S | h. cm. | € |
|----------|----------|--------|-------|
| 42662P14 | 42662S14 | 14 | 43,11 |

Beech wood. – Faggio.



AY
W

OLERON Herbs/chili mill

Macina erbe/peperoncino
Kräuter-/Paprikamühle
Moulin à herbes/piment
Molinillo hierbas/chile

| art. | h. cm. | € |
|----------|--------|-------|
| 42662C14 | 14 | 47,03 |

Beech wood. – Faggio.



AY
SS

OUESSANT Pepper/salt mill

Macina pepe/sale
Pfeffer-/Salzmühle
Moulin à poivre/sel
Molinillo pimienta/sal

| art.-P | art.-S | h. cm. | € |
|----------|----------|--------|-------|
| 42669P14 | 42669S14 | 14 | 48,94 |



AY
SS

OUESSANT Herbs/chili mill

Macina erbe/peperoncino
Kräuter-/Paprikamühle
Moulin à herbes/piment
Molinillo hierbas/chile

| art. | h. cm. | € |
|----------|--------|-------|
| 42669C14 | 14 | 53,87 |



AY
W

OLERON Pepper/salt mill

Macina pepe/sale
Pfeffer-/Salzmühle
Moulin à poivre/sel
Molinillo pimienta/sal

| art.-P | art.-S | h. cm. | € |
|----------|----------|--------|-------|
| 42663P14 | 42663S14 | 14 | 43,11 |

Beech wood. – Faggio.



AY
W

OLERON Herbs/chili mill

Macina erbe/peperoncino
Kräuter-/Paprikamühle
Moulin à herbes/piment
Molinillo hierbas/chile

| art. | h. cm. | € |
|----------|--------|-------|
| 42663C14 | 14 | 47,03 |

Beech wood. – Faggio.



W

ISEN Nutmeg mill

Macina noce moscata
Muskatmühle
Moulin à mouscade
Molinillo nuez moscada

| art. | h. cm. | col. | € |
|----------|--------|------|-------|
| 42689-15 | 15 | ● | 58,79 |
| 42690-15 | 15 | ● | 58,79 |

Natural & black matt. – Naturale & nero opaco.





SS
AY

DAMAN Nutmeg mill
Macina noce moscata
Muskatmühle
Moulin à mouscade
Molinillo nuez moscada

| art. | h. cm. | € |
|----------|--------|-------|
| 42764M15 | 15 | 58,79 |

Magnetic stopper. Compartment for 3 nutmegs.
Tappo magnetico. Scompartimento per 3 noci.



W
AY

MADRAS Nutmeg mill
Macina noce moscata
Muskatmühle
Moulin à mouscade
Molinillo nuez moscada

| art. | h. cm. | € |
|----------|--------|-------|
| 42705M15 | 15 | 53,87 |

Beech wood chocolate. Magnetic stopper. Compartment for 3 nutmegs. – Faggio cioccolato. Tappo magnetico. Scompartimento per 3 noci.



AY
ABS

TIDORE Nutmeg mill
Macina noce moscata
Muskatmühle
Moulin à mouscade
Molinillo nuez moscada

| art. | h. cm. | € |
|----------|--------|-------|
| 42720-01 | 11 | 44,12 |

Chromed. Compartment for 7/8 nutmegs.
Cromata. Serbatoio per 7/8 noci.



NEW

SELECT
MOUTURE SUR MESURE

MAESTRO GRAPHITE Pepper mill
Macina pepe
Pfeffermühle
Moulin à poivre
Molinillo pimienta

| art. | € |
|----------|-------|
| 42621P11 | 54,17 |



NEW

MAESTRO Set of 3 jars
Set 3 vasetti intercambiabili
Set 3 Gläser
Set 3 réservoirs interchangeables
Juego de 3 tarros

| art. | € |
|----------|-------|
| 42621P03 | 14,67 |

Incl. erasable marker.
Incl. pennarello cancellabile.





BBQ Pepper mill

Macina pepe
Pfeffermühle
Moulin à poivre
Molinillo pimienta

| art. | h. cm. | € |
|----------|--------|-------|
| 42631P30 | 30 | 83,82 |



PALACE Pepper/salt mill

Macina pepe/sale
Pfeffer-/Salzmühle
Moulin à poivre/sel
Molinillo pimienta/sal

| art-P | art-S | h. cm. | € |
|----------|----------|--------|--------|
| 42725P10 | 42725S10 | 10 | 116,88 |



MIGNONNETTE Pepper/salt mill

Macina pepe/sale
Pfeffer-/Salzmühle
Moulin à poivre/sel
Molinillo pimienta/sal

| art-P | art-S | h. cm. | € |
|----------|----------|--------|--------|
| 42723P10 | 42723S10 | 10 | 175,77 |



LANKA Cinnamon shaker/mill

Macina & spargi cannella
Zimt Shaker-/Mühle
Shaker et moulin à cannelle
Especiero y molinillo de canela

| art. | h. cm. | € |
|----------|--------|-------|
| 42685-22 | 22-7 | 76,48 |

To grind cinnamon sticks (6 cm max). Shaker and mill function. – Per macinare bastoncini di cannella (max 6 cm). Funzione shaker e macina.





W
SS

ISEN Flax seeds mill

Macina semi lino/sesamo

Leinsamen-Mühle

Moulin à graines de lin

Molino de semillas de lino

| art. | h. cm. | € |
|----------|--------|-------|
| 42680-13 | 13 | 78,39 |

Supplied with spoon of 5 g. and brush.

Fornito con un cucchiaino da 5 g. e scovolino.



W
SS

ISEN Long pepper mill

Macina pepe lungo

Langer Pfeffermühle

Moulin à poivres longs

Molinillo de pimienta larga

| art. | h. cm. | € |
|----------|--------|--------|
| 42681-16 | 16 | 103,82 |

To grind long pepper and very large peppercorns. Adjustable grinding. Comes with cleaning brush. Also works for cardamom, star anise, tonka beans, cloves, coriander. – Per macinare pepe lungo e grani di pepe molto grandi. Regolabile. Fornito con scovolino. Funziona anche con cardamomo, anice stellato, fave tonka, chiodi di garofano, coriandolo.



NEW
SS
ABS

CIRO Oil & vinegar pourer 9 pcs

Versa olio e aceto, display 9 pz

Öl- und Essigausgießer, 9 Stk

Verseur huile & vinaigre, 9 pcs

Vertedor de aceite y vinagre, 9 pz

| art. | € |
|----------|--------|
| 42629-09 | 132,31 |

Fits in most bottles. Neck Ø 17,5-21 mm. Leak-proof system. 4 settings: close, drop, drizzle, continous. Dishwasher safe. – Si adatta alla maggior parte delle bottiglie. Collo Ø 17,5-21 mm. 4 impostazioni: chiuso, goccia, goccioline, flusso continuo. Sistema antigoccia. Lavabile in lavastoviglie.







AY

PC



ALASKA Duo, pepper/salt mill

Duo, macinapepe/sale, elettrici

Duo, Pfeffer-/Salzmühle

Duo, moulin à poivre/sel

Duo, molinillo pimienta/sal

| art. | h. cm. | € |
|----------|--------|--------|
| 42660-02 | 17 | 122,61 |



ABS



ZELI Pepper/salt mill

Macina pepe/sale

Pfeffer-/Salzmühle

Moulin à poivre/sel

Molinillo pimienta/sal

| art.-P | art.-S | h. cm. | € |
|----------|----------|--------|-------|
| 42801P14 | 42801S14 | 14 | 63,72 |

Stainless steel look. – Imitazione inox.



SS



SELECT
MOUTURE SUR MESURE

ELIS SENSE Pepper/salt mill

Macina pepe/sale

Pfeffer-/Salzmühle

Moulin à poivre/sel

Molinillo pimienta/sal

| art.-P | art.-S | h. cm. | € |
|----------|----------|--------|--------|
| 42785S20 | 42786S20 | 20 | 107,03 |

With small dish and spice vial with funnel.
Con vassoietto e fiala dosatrice con imbuto.



TABLE TOP TAVOLA
PEUGEOT MILLS MACINE



NEW



SELECT
MOUTURE SUR MESURE



NEW



SELECT
MOUTURE SUR MESURE

DAMAN Duo, pepper/salt mill

Duo, macinapepe/sale, elettrici

Duo, Pfeffer-/Salzmühle

Duo, moulin à poivre/sel

Duo, molinillo pimienta/sal

| art. | h. cm. | € |
|----------|--------|--------|
| 42763-02 | 16 | 147,13 |

DAMAN

Macina pepe/sale

Pfeffer-/Salzmühle

Moulin à poivre/sel

Molinillo pimienta/sal

| art.-P | art.-S | h. cm. | € |
|----------|----------|--------|-------|
| 42763P16 | 42763S16 | 16 | 78,39 |



NEW

SELECT
MOUTURE SUR MESURE



NEW

SELECT
MOUTURE SUR MESURE

LINE Duo, pepper/salt mill

Duo, macinapepe/sale, elettrici

Duo, Pfeffer-/Salzmühle

Duo, moulin à poivre/sel

Duo, molinillo pimienta/sal

| art. | h. cm. | € |
|----------|--------|--------|
| 42622-02 | 15 | 166,83 |

LINE Pepper/salt mill

Macina pepe/sale

Pfeffer-/Salzmühle

Moulin à poivre/sel

Molinillo pimienta/sal

| art.-P | art.-S | h. cm. | € |
|----------|----------|--------|-------|
| 42622P15 | 42622S15 | 15 | 88,24 |

USB - Rechargeable. – Ricaricabile via USB.

USB - Rechargeable. – Ricaricabile via USB.



ENAMELLED CERAMIC BAKEWARE CERAMICA SMALTATA DA FORNO



FACILE DA PULIRE

With the range of Appolia vitrified enamel ceramics, Peugeot demonstrates its know-how and expertise in the field of oven dishes.



COLORE E BRILLANTEZZA
DI LUNGA DURATA

It is in France, in the heart of Brittany, in its ceramic factory founded more than 80 years ago, that Peugeot produces Appolia products. The workshop has awarded the EPV label "Entreprise du Patrimoine Vivant" - a sign of recognition by the State that distinguishes French companies with excellent craftsmanship and industrial know-how.



SUPERFICIE ULTRA
LISCIA ANTIABRASIONE

A noble material, Peugeot ceramic guarantees regular and homogeneous cooking for a healthy and tasty cuisine. A well-kept secret, the recipe for ceramic paste, a mix of clay, kaolin and feldspar, gives the product a remarkable resistance to mechanical shocks.

Simple and contemporary lines, Appolia has been designed to offer practicality and express flavors.



Con la gamma di ceramiche smaltate Appolia, Peugeot dimostra il suo know-how e la sua competenza nel campo delle pirofile da forno.

È in Francia, nel cuore della Bretagna, nella sua manifattura di ceramica fondata da più di 80 anni, che Peugeot produce i prodotti Appolia. L'officina è stata premiata con l'etichetta EPV "Entreprise du Patrimoine Vivant" - un segno di riconoscimento da parte dello Stato che distingue le aziende francesi con un'eccellente know-how artigianale e industriale.

Un materiale nobile, la ceramica Peugeot garantisce una cottura regolare e omogenea per una cucina sana e gustosa. Un segreto ben custodito, la ricetta della pasta ceramica, un mix di argilla, caolino e feldspato, conferisce al prodotto una notevole resistenza agli urti meccanici.

Linee pulite e contemporanee, Appolia è stata progettata per offrire praticità ed esprimere i sapori.

Appolia dishes are suitable for use in the oven (250°C), microwave, freezer (-20°C). Dishwasher safe. Produced with 100% natural ingredients (mixture of clays, kaolin, silica, feldspar), 100% recyclable. They guarantee a delicate and tasty, healthy and homogeneous cooking. They have exceptional thermal inertia: they retain heat for up to 30 minutes - they help keep food hot or cold. The material is not porous, does not absorb odors, greases or liquids. The hardness of the final product gives the oven dishes a high mechanical resistance to shocks, scratches and acids. The resistance of Peugeot vitrified enamel has been tested by an independent laboratory. Easy to clean with a simple sponge. Long-lasting color and shine. Comfortable and easy to use, wide and striped handles for a secure grip; rounded corners, facilitate service and cleaning; deep, they offer more volume; allow the retention of cooking juices in order to preserve all the flavors, they are stackable one inside the other to save space. A collection for every day, beautiful, durable and versatile for the table. Available in 6 colors: red, ecru, blue - timeless and essential shades; slate, eggplant, terracotta - contemporary and chic shades.

Le pirofile Appolia sono idonee all'uso in forno (250°C), microonde, congelatore (-20°C). Lavabili in lavastoviglie. Prodotte con ingredienti naturali al 100% (miscela di argille, caolino, silice, feldspato), 100% riciclabili. Garantiscono una cottura delicata e gustosa, sana e omogenea. Hanno eccezionale inerzia termica: trattengono il calore fino a 30 minuti - aiutano a mantenere il cibo caldo o freddo. Il materiale non è poroso, non assorbe odori, grassi o liquidi. La durezza del prodotto finale conferisce alle pirofile un'elevata resistenza meccanica agli urti, graffi e acidi. La resistenza dello smalto vetrificato di Peugeot è stata testata da un laboratorio indipendente. Facile da pulire con una semplice spugna. Colore e brillantezza di lunga durata. Comode e facili da usare, maniglie larghe e striate per una presa sicura; angoli arrotondati, facilitano il servizio e la pulizia; profonde, offrono più volume; consentono la ritenzione dei succhi di cottura in modo da preservare tutti i sapori, sono impilabili l'una nell'altra per un risparmio di spazio. Una collezione per tutti i giorni, bella, durevole e versatile dalla cucina alla tavola. Disponibile in 6 colori: rosso, ecru, blu - tonalità senza tempo ed essenziali; ardesia, melanzana, terracotta - tonalità contemporanee e chic.



Rectangular baker RED

Pirofila rettangolare
Rechteckige Ofenschale
Plat four rectangulaire
Plato horno rectangular

| art. | cm. int. | cm. est. | lt. | Kg. | € |
|----------|-------------|-------------|------|------|-------|
| 44701R22 | 18x12x4,5 | 22x13x5 | 0,85 | 0,68 | 23,62 |
| 44701R25 | 20x15,5x5,5 | 25x16,8x6,2 | 1,4 | 0,9 | 34,07 |
| 44701R32 | 26x20x6,5 | 32x21,7x7,2 | 2,7 | 1,7 | 45,83 |
| 44701R36 | 30x22x6,8 | 36x23,6x7,5 | 3,8 | 2,2 | 56,48 |
| 44701R40 | 33x25,7x7,5 | 40x27,2x8,3 | 5,2 | 2,8 | 62,31 |



Square baker RED

Pirofila quadra
Quadratische Ofenschale
Plat four carré
Plato horno cuadrado

| art. | cm. int. | cm. est. | lt. | Kg. | € |
|----------|---------------|-------------|------|------|-------|
| 44702R18 | 13x13x4,5 | 18x14x5 | 0,66 | 0,55 | 23,62 |
| 44702R21 | 16,3x16,3x5,4 | 21x17,5x6 | 1,1 | 0,8 | 31,66 |
| 44702R28 | 22,5x22,5x6,5 | 28x23,7x7,2 | 2,7 | 1,6 | 41,10 |
| 44702R36 | 29,5x29,5x7,5 | 36x31x8,2 | 5,4 | 2,8 | 57,59 |



Round baker RED

Pirofila tonda
Runde Ofenschale
Plat four rond
Plato horno redondo

| art. | Ø cm. | h. cm. | cm. est. | lt. | Kg. | € |
|----------|-------|--------|-------------|-----|------|-------|
| 44703R27 | 23 | 6 | 27x23,4x6,7 | 2,1 | 1,15 | 40,00 |
| 44703R34 | 30 | 7 | 34x29,5x7,7 | 3,8 | 2,10 | 52,86 |



Soufflé dish RED

Pirofila soufflé
Soufflé Ofenschale
Plat four soufflé
Plato horno soufflé

| art. | Ø cm. | h. cm. | cm. est. | lt. | Kg. | € |
|----------|-------|--------|-------------|------|------|-------|
| 44704R22 | 22 | 8,5 | 24x21,7x9,7 | 2,40 | 1,50 | 38,79 |

NEW



Oval baker RED

Pirofila ovale
Ovale Ofenschale
Plat four ovale
Plato horno ovalado

| art. | cm. int. | cm. est. | lt. | Kg. | € |
|----------|---------------|-------------|-----|-----|-------|
| 44706R31 | 27x20x6 | 31x21,5x7 | 2,2 | 1,4 | 41,10 |
| 44706R40 | 34,5x25,5x7,5 | 40x27,2x8,2 | 4,5 | 2,4 | 64,72 |



Tray RED

Vassoio
Tablett
Plateau
Bandeja

| art. | cm. int. | cm. est. | lt. | Kg. | € |
|----------|-------------|-------------|-----|------|-------|
| 44707R40 | 34,5x16x1,5 | 40x17,8x2,5 | - | 1,35 | 38,79 |

NEW



Round baker RED
Pirofila tonda
Runde Ofenschale
Plat four rond
Plato horno redondo

| art. | Ø cm. | h. cm. | cm. est. | lt. | Kg. | € |
|----------|-------|--------|-------------|-----|-----|-------|
| 44708R28 | 28 | 4,5 | 33x28,3x5,4 | 2,2 | 1,5 | 43,52 |



NEW

Round baker RED
Pirofila tonda
Runde Ofenschale
Plat four rond
Plato horno redondo

| art. | Ø cm. | h. cm. | cm. est. | lt. | Kg. | € |
|----------|-------|--------|-------------|------|------|-------|
| 44708R30 | 30 | 3,5 | 35x30,5x4,3 | 2,40 | 1,60 | 43,52 |



NEW

Rectangular baker RED
Pirofila rettangolare
Rechteckige Ofenschale
Plat four rectangulaire
Plato horno rectangular

| art. | cm. int. | cm. est. | lt. | Kg. | € |
|----------|----------|-------------|------|------|-------|
| 44709R31 | 26x11x8 | 31x12,4x8,7 | 2,00 | 1,30 | 38,79 |



NEW

Terrine dish with lid RED
Terrina con coperchio
Terrine mit Deckel
Terrine avec couvercle
Plato horno pan con tapa

| art. | cm. int. | cm. est. | lt. | Kg. | € |
|----------|------------|-----------|------|------|-------|
| 44710R20 | 15,5x9,2x6 | 20x11x7,5 | 0,65 | 0,85 | 50,55 |





Rectangular baker TERRACOTTA

Pirofila rettangolare

Rechteckige Ofenschale

Plat four rectangulaire

Plato horno rectangular

| art. | cm. int. | cm. est. | lt. | Kg. | € |
|----------|-------------|-------------|-----|-----|-------|
| 44701T25 | 20x15,5x5,5 | 25x16,8x6,2 | 1,4 | 0,9 | 34,07 |
| 44701T32 | 26x20x6,5 | 32x21,7x7,2 | 2,7 | 1,7 | 45,83 |
| 44701T40 | 33x25,7x7,5 | 40x27,2x8,3 | 5,2 | 2,8 | 62,31 |

Square baker TERRACOTTA

Pirofila quadra

Quadratische Ofenschale

Plat four carré

Plato horno cuadrado

| art. | cm. int. | cm. est. | lt. | Kg. | € |
|----------|---------------|-------------|-----|-----|-------|
| 44702T21 | 16,3x16,3x5,4 | 21x17,5x6 | 1,1 | 0,8 | 31,66 |
| 44702T28 | 22,5x22,5x6,5 | 28x23,7x7,2 | 2,7 | 1,6 | 41,10 |
| 44702T36 | 29,5x29,5x7,5 | 36x31x8,2 | 5,4 | 2,8 | 57,59 |





Rectangular baker EGGPLANT

Pirofila rettangolare
Rechteckige Ofenschale
Plat four rectangulaire
Plato horno rectangular

| art. | cm. int. | cm. est. | lt. | Kg. | € |
|----------|-------------|-------------|-----|-----|-------|
| 44701M25 | 20x15,5x5,5 | 25x16,8x6,2 | 1,4 | 0,9 | 34,07 |
| 44701M32 | 26x20x6,5 | 32x21,7x7,2 | 2,7 | 1,7 | 45,83 |
| 44701M40 | 33x25,7x7,5 | 40x27,2x8,3 | 5,2 | 2,8 | 62,31 |

Square baker EGGPLANT

Pirofila quadra
Quadratische Ofenschale
Plat four carré
Plato horno cuadrado

| art. | cm. int. | cm. est. | lt. | Kg. | € |
|----------|---------------|-------------|-----|-----|-------|
| 44702M21 | 16,3x16,3x5,4 | 21x17,5x6 | 1,1 | 0,8 | 31,66 |
| 44702M28 | 22,5x22,5x6,5 | 28x23,7x7,2 | 2,7 | 1,6 | 41,10 |
| 44702M36 | 29,5x29,5x7,5 | 36x31x8,2 | 5,4 | 2,8 | 57,59 |





Rectangular baker ECRU

Pirofila rettangolare
Rechteckige Ofenschale
Plat four rectangulaire
Plato horno rectangular

| art. | cm. int. | cm. est. | lt. | Kg. | € |
|----------|-------------|-------------|------|------|-------|
| 44701C22 | 18x12x4,5 | 22x13x5 | 0,85 | 0,68 | 23,62 |
| 44701C25 | 20x15,5x5,5 | 25x16,8x6,2 | 1,4 | 0,9 | 34,07 |
| 44701C32 | 26x20x6,5 | 32x21,7x7,2 | 2,7 | 1,7 | 45,83 |
| 44701C36 | 30x22x6,8 | 36x23,6x7,5 | 3,8 | 2,2 | 56,48 |
| 44701C40 | 33x25,7x7,5 | 40x27,2x8,3 | 5,2 | 2,8 | 62,31 |



Square baker ECRU

Pirofila quadra
Quadratische Ofenschale
Plat four carré
Plato horno cuadrado

| art. | cm. int. | cm. est. | lt. | Kg. | € |
|----------|---------------|-------------|------|------|-------|
| 44702C18 | 13x13x4,5 | 18x14x5 | 0,66 | 0,55 | 23,62 |
| 44702C21 | 16,3x16,3x5,4 | 21x17,5x6 | 1,1 | 0,8 | 31,66 |
| 44702C28 | 22,5x22,5x6,5 | 28x23,7x7,2 | 2,7 | 1,6 | 41,10 |
| 44702C36 | 29,5x29,5x7,5 | 36x31x8,2 | 5,4 | 2,8 | 57,59 |



Round baker ECRU

Pirofila tonda
Runde Ofenschale
Plat four rond
Plato horno redondo

| art. | Ø cm. | h. cm. | cm. est. | lt. | Kg. | € |
|----------|-------|--------|-------------|-----|------|-------|
| 44703C27 | 23 | 6 | 27x23,4x6,7 | 2,1 | 1,15 | 40,00 |
| 44703C34 | 30 | 7 | 34x29,5x7,7 | 3,8 | 2,10 | 52,86 |



Soufflé dish ECRU

Pirofila soufflé
Soufflé Ofenschale
Plat four soufflé
Plato horno soufflé

| art. | Ø cm. | h. cm. | cm. est. | lt. | Kg. | € |
|----------|-------|--------|-------------|------|------|-------|
| 44704C22 | 22 | 8,5 | 24x21,7x9,7 | 2,40 | 1,50 | 38,79 |

NEW



Oval baker ECRU

Pirofila ovale
Ovale Ofenschale
Plat four ovale
Plato horno ovalado

| art. | cm. int. | cm. est. | lt. | Kg. | € |
|----------|---------------|-------------|-----|-----|-------|
| 44706C31 | 27x20x6 | 31x21,5x7 | 2,2 | 1,4 | 41,10 |
| 44706C40 | 34,5x25,5x7,5 | 40x27,2x8,2 | 4,5 | 2,4 | 64,72 |



Tray ECRU

Vassoio
Tablett
Plateau
Bandeja

| art. | cm. int. | cm. est. | lt. | Kg. | € |
|----------|-------------|-------------|-----|------|-------|
| 44707C40 | 34,5x16x1,5 | 40x17,8x2,5 | - | 1,35 | 38,79 |

NEW



NEW

Round baker ECRU

Pirofila tonda
Runde Ofenschale
Plat four rond
Plato horno redondo

| art. | Ø cm. | h. cm. | cm. est. | lt. | Kg. | € |
|----------|-------|--------|-------------|------|------|-------|
| 44708C28 | 28 | 4,5 | 33x28,3x5,4 | 2,2 | 1,5 | 43,52 |
| 44708C30 | 30 | 3,5 | 35x30,5x4,3 | 2,40 | 1,60 | 43,52 |

Rectangular baker ECRU

Pirofila rettangolare
Rechteckige Ofenschale
Plat four rectangulaire
Plato horno rectangular

| art. | cm. int. | cm. est. | lt. | Kg. | € |
|----------|----------|-------------|------|------|-------|
| 44709C31 | 26x11x8 | 31x12,4x8,7 | 2,00 | 1,30 | 38,79 |



Bread pan with lid ECRU

Stampo pane con coperchio
Brotform mit Deckel
Plaque boulangère multipains a/couv
Plato panadero con tapa

| art. | cm. int. | cm. est. | lt. | Kg. | € |
|----------|----------|---------------|-----|-----|-------|
| 44705C37 | 31,5x21 | 37,5x22,7x7,5 | - | 3,0 | 94,17 |





Rectangular baker BLUE

Pirofila rettangolare
Rechteckige Ofenschale
Plat four rectangulaire
Plato horno rectangular

| art. | cm. int. | cm. est. | lt. | Kg. | € |
|----------|-------------|-------------|-----|-----|-------|
| 44701B25 | 20x15,5x5,5 | 25x16,8x6,2 | 1,4 | 0,9 | 34,07 |
| 44701B32 | 26x20x6,5 | 32x21,7x7,2 | 2,7 | 1,7 | 45,83 |
| 44701B36 | 30x22x6,8 | 36x23,6x7,5 | 3,8 | 2,2 | 56,48 |
| 44701B40 | 33x25,7x7,5 | 40x27,2x8,3 | 5,2 | 2,8 | 62,31 |



Square baker BLUE

Pirofila quadra
Quadratische Ofenschale
Plat four carré
Plato horno cuadrado

| art. | cm. int. | cm. est. | lt. | Kg. | € |
|----------|---------------|-------------|-----|-----|-------|
| 44702B21 | 16,3x16,3x5,4 | 21x17,5x6 | 1,1 | 0,8 | 31,66 |
| 44702B28 | 22,5x22,5x6,5 | 28x23,7x7,2 | 2,7 | 1,6 | 41,10 |
| 44702B36 | 29,5x29,5x7,5 | 36x31x8,2 | 5,4 | 2,8 | 57,59 |



Square baker BLUE

Pirofila tonda
Runde Ofenschale
Plat four rond
Plato horno redondo

| art. | Ø cm. | h. cm. | cm. est. | lt. | Kg. | € |
|----------|-------|--------|-------------|-----|------|-------|
| 44703B27 | 23 | 6 | 27x23,4x6,7 | 2,1 | 1,15 | 40,00 |
| 44703B34 | 30 | 7 | 34x29,5x7,7 | 3,8 | 2,10 | 52,86 |



Soufflé dish BLUE

Pirofila soufflé
Soufflé Ofenschale
Plat four soufflé
Plato horno soufflé

| art. | Ø cm. | h. cm. | cm. est. | lt. | Kg. | € |
|----------|-------|--------|-------------|------|------|-------|
| 44704B22 | 22 | 8,5 | 24x21,7x9,7 | 2,40 | 1,50 | 38,79 |

NEW



Round baker BLUE

Pirofila tonda
Runde Ofenschale
Plat four rond
Plato horno redondo

| art. | Ø cm. | h. cm. | cm. est. | lt. | Kg. | € |
|----------|-------|--------|-------------|------|------|-------|
| 44708B28 | 28 | 4,5 | 33x28,3x5,4 | 2,2 | 1,5 | 43,52 |
| 44708B30 | 30 | 3,5 | 35x30,5x4,3 | 2,40 | 1,60 | 43,52 |



Rectangular baker BLUE

Pirofila rettangolare
Rechteckige Ofenschale
Plat four rectangulaire
Plato horno rectangular

| art. | cm. int. | cm. est. | lt. | Kg. | € |
|----------|----------|-------------|------|------|-------|
| 44709B31 | 26x11x8 | 31x12,4x8,7 | 2,00 | 1,30 | 38,79 |

NEW





Rectangular baker SLATE

Pirofila rettangolare
Rechteckige Ofenschale
Plat four rectangulaire
Plato horno rectangular

| art. | cm. int. | cm. est. | lt. | Kg. | € |
|----------|-------------|-------------|------|------|-------|
| 44701S22 | 18x12x4,5 | 22x13x5 | 0,85 | 0,68 | 23,62 |
| 44701S25 | 20x15,5x5,5 | 25x16,8x6,2 | 1,4 | 0,9 | 34,07 |
| 44701S32 | 26x20x6,5 | 32x21,7x7,2 | 2,7 | 1,7 | 45,83 |
| 44701S36 | 30x22x6,8 | 36x23,6x7,5 | 3,8 | 2,2 | 56,48 |
| 44701S40 | 33x25,7x7,5 | 40x27,2x8,3 | 5,2 | 2,8 | 62,31 |



Square baker SLATE

Pirofila quadra
Quadratische Ofenschale
Plat four carré
Plato horno cuadrado

| art. | cm. int. | cm. est. | lt. | Kg. | € |
|----------|---------------|-------------|------|------|-------|
| 44702S18 | 13x13x4,5 | 18x14x5 | 0,66 | 0,55 | 23,62 |
| 44702S21 | 16,3x16,3x5,4 | 21x17,5x6 | 1,1 | 0,8 | 31,66 |
| 44702S28 | 22,5x22,5x6,5 | 28x23,7x7,2 | 2,7 | 1,6 | 41,10 |
| 44702S36 | 29,5x29,5x7,5 | 36x31x8,2 | 5,4 | 2,8 | 57,59 |



Round baker SLATE

Pirofila tonda
Runde Ofenschale
Plat four rond
Plato horno redondo

| art. | Ø cm. | h. cm. | cm. est. | lt. | Kg. | € |
|----------|-------|--------|-------------|-----|------|-------|
| 44703S27 | 23 | 6 | 27x23,4x6,7 | 2,1 | 1,15 | 40,00 |
| 44703S34 | 30 | 7 | 34x29,5x7,7 | 3,8 | 2,10 | 52,86 |



Soufflé dish SLATE

Pirofila soufflé
Soufflé Ofenschale
Plat four soufflé
Plato horno soufflé

| art. | Ø cm. | h. cm. | cm. est. | lt. | Kg. | € |
|----------|-------|--------|-------------|------|------|-------|
| 44704S22 | 22 | 8,5 | 24x21,7x9,7 | 2,40 | 1,50 | 38,79 |

NEW



Oval baker SLATE

Pirofila ovale
Ovale Ofenschale
Plat four ovale
Plato horno ovalado

| art. | cm. int. | cm. est. | lt. | Kg. | € |
|----------|---------------|-------------|-----|-----|-------|
| 44706S31 | 27x20x6 | 31x21,5x7 | 2,2 | 1,4 | 41,10 |
| 44706S40 | 34,5x25,5x7,5 | 40x27,2x8,2 | 4,5 | 2,4 | 64,72 |



Tray SLATE

Vassoio
Tablett
Plateau
Bandeja

| art. | cm. int. | cm. est. | lt. | Kg. | € |
|----------|-------------|-------------|-----|------|-------|
| 44707S40 | 34,5x16x1,5 | 40x17,8x2,5 | - | 1,35 | 38,79 |

NEW



Round baker SLATE

Pirofila tonda
Runde Ofenschale
Plat four rond
Plato horno redondo

| art. | Ø cm. | h. cm. | cm. est. | lt. | Kg. | € |
|----------|-------|--------|-------------|-----|-----|-------|
| 44708S28 | 28 | 4,5 | 33x28,3x5,4 | 2,2 | 1,5 | 43,52 |



NEW

Round baker SLATE

Pirofila tonda
Runde Ofenschale
Plat four rond
Plato horno redondo

| art. | Ø cm. | h. cm. | cm. est. | lt. | Kg. | € |
|----------|-------|--------|-------------|------|------|-------|
| 44708S30 | 30 | 3,5 | 35x30,5x4,3 | 2,40 | 1,60 | 43,52 |



NEW

Rectangular baker SLATE

Pirofila rettangolare
Rechteckige Ofenschale
Plat four rectangulaire
Plato horno rectangular

| art. | cm. int. | cm. est. | lt. | Kg. | € |
|----------|----------|-------------|------|------|-------|
| 44709S31 | 26x11x8 | 31x12,4x8,7 | 2,00 | 1,30 | 38,79 |



NEW

Terrine dish with lid SLATE

Terrina con coperchio
Terrine mit Deckel
Terrine avec couvercle
Plato horno pan con tapa

| art. | cm. int. | cm. est. | lt. | Kg. | € |
|----------|------------|-----------|------|------|-------|
| 44710S20 | 15,5x9,2x6 | 20x11x7,5 | 0,65 | 0,85 | 50,55 |



INDIVIDUAL PORTIONS - FROM THE KITCHEN TO THE TABLE
LE MONOPORZIONI - DALLA CUCINA SERVINTAVOLA





Pirofila Rettangolare Monoporzione ECRU

Pirofila Rettangolare Monoporzione
Rechteckige Ofenschale 1 Portion
Plat four rectangulaire portion individuelle
Plato horno rectangular porción individual

| art. | cm. int. | cm. est. | lt. | Kg. | € |
|----------|-----------|----------|------|------|-------|
| 44701C22 | 18x12x4,5 | 22x13x5 | 0,85 | 0,68 | 23,62 |



Pirofila Quadra Monoporzione ECRU

Pirofila Quadra Monoporzione
Quadratische Ofenschale 1 Portion
Plat four carré portion individuelle
Plato horno cuadrado porción individual

| art. | cm. int. | cm. est. | lt. | Kg. | € |
|----------|-----------|----------|------|------|-------|
| 44702C18 | 13x13x4,5 | 18x14x5 | 0,66 | 0,55 | 23,62 |



Pirofila Rettangolare Monoporzione RED

Pirofila Rettangolare Monoporzione
Rechteckige Ofenschale 1 Portion
Plat four rectangulaire portion individuelle
Plato horno rectangular porción individual

| art. | cm. int. | cm. est. | lt. | Kg. | € |
|----------|-----------|----------|------|------|-------|
| 44701R22 | 18x12x4,5 | 22x13x5 | 0,85 | 0,68 | 23,62 |



Pirofila Quadra Monoporzione RED

Pirofila Quadra Monoporzione
Quadratische Ofenschale 1 Portion
Plat four carré portion individuelle
Plato horno cuadrado porción individual

| art. | cm. int. | cm. est. | lt. | Kg. | € |
|----------|-----------|----------|------|------|-------|
| 44702R18 | 13x13x4,5 | 18x14x5 | 0,66 | 0,55 | 23,62 |



Pirofila Rettangolare Monoporzione SLATE

Pirofila Rettangolare Monoporzione
Rechteckige Ofenschale 1 Portion
Plat four rectangulaire portion individuelle
Plato horno rectangular porción individual

| art. | cm. int. | cm. est. | lt. | Kg. | € |
|----------|-----------|----------|------|------|-------|
| 44701S22 | 18x12x4,5 | 22x13x5 | 0,85 | 0,68 | 23,62 |



Pirofila Quadra Monoporzione SLATE

Pirofila Quadra Monoporzione
Quadratische Ofenschale 1 Portion
Plat four carré portion individuelle
Plato horno cuadrado porción individual

| art. | cm. int. | cm. est. | lt. | Kg. | € |
|----------|-----------|----------|------|------|-------|
| 44702S18 | 13x13x4,5 | 18x14x5 | 0,66 | 0,55 | 23,62 |



YELLOW SAFFRON - STRONG AND BRIGHT.
GIALLO ZAFFERANO - FORTE E BRILLANTE.

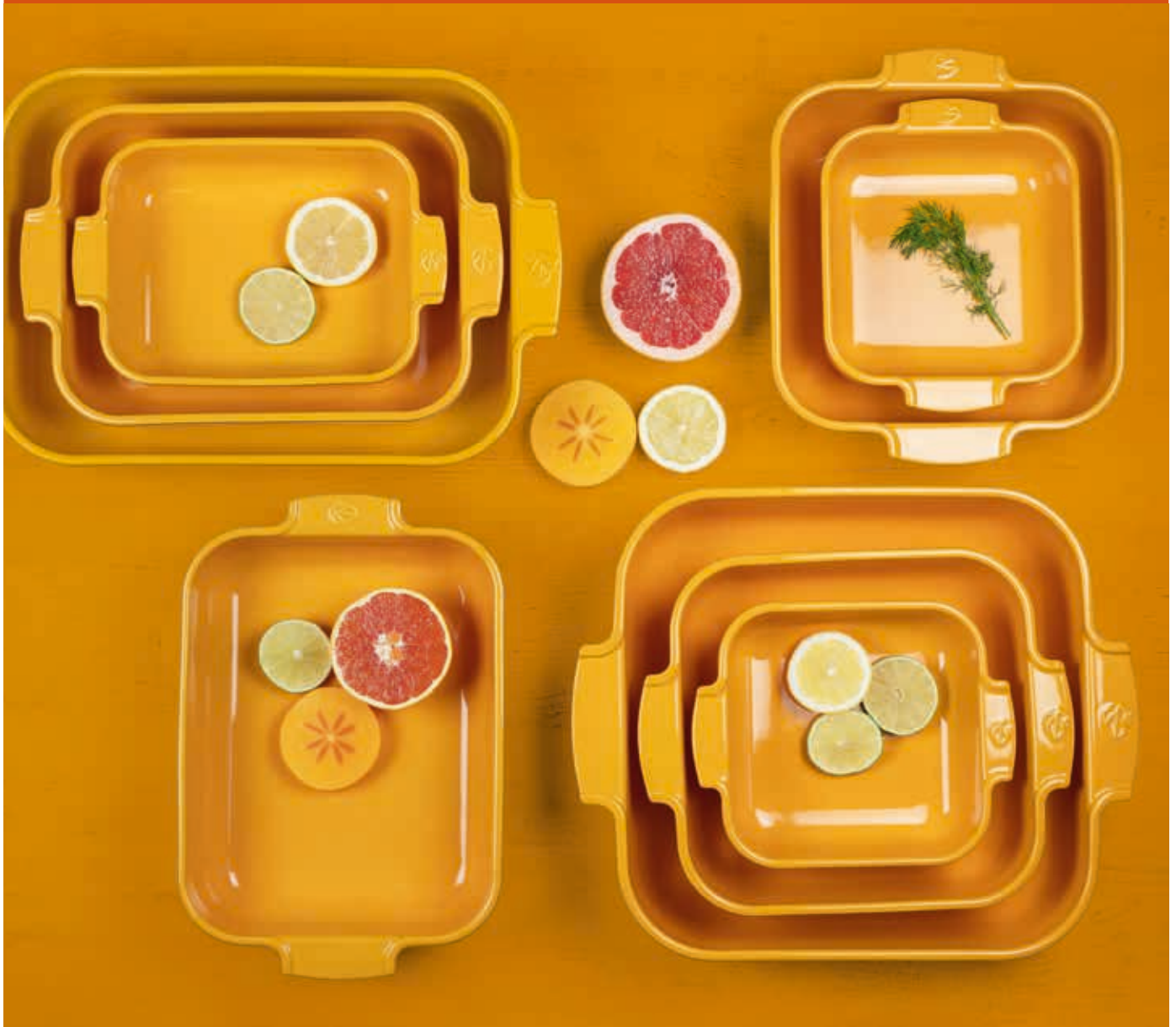

Rectangular baker

Pirofila rettangolare

Rechteckige Ofenschale

Plat four rectangulaire

Plato horno rectangular

| art. | cm. int. | cm. est. | lt. | Kg. | € |
|----------|-------------|-------------|-----|-----|-------|
| 44701Y25 | 20x15,5x5,5 | 25x16,8x6,2 | 1,4 | 0,9 | 34,07 |
| 44701Y32 | 26x20x6,5 | 32x21,7x7,2 | 2,7 | 1,7 | 45,83 |
| 44701Y36 | 30x22x6,8 | 36x23,6x7,5 | 3,8 | 2,2 | 56,48 |
| 44701Y40 | 33x25,7x7,5 | 40x27,2x8,3 | 5,2 | 2,8 | 62,31 |



Square baker

Pirofila quadra

Quadratische Ofenschale

Plat four carré

Plato horno cuadrado

| art. | cm. int. | cm. est. | lt. | Kg. | € |
|----------|---------------|-------------|-----|-----|-------|
| 44702Y21 | 16,3x16,3x5,4 | 21x17,5x6 | 1,1 | 0,8 | 31,66 |
| 44702Y28 | 22,5x22,5x6,5 | 28x23,7x7,2 | 2,7 | 1,6 | 41,10 |
| 44702Y36 | 29,5x29,5x7,5 | 36x31x8,2 | 5,4 | 2,8 | 57,59 |

SATIN BLACK - SOBER WITH CHARACTER AND ELEGANCE.
NERO SATINATO - SOBRIO CON CARATTERE ED ELEGANTE.

NEW



Rectangular baker

Pirofila rettangolare
 Rechteckige Ofenschale
 Plat four rectangulaire
 Plato horno rectangular

| art. | cm. int. | cm. est. | lt. | Kg. | € |
|----------|-------------|-------------|------|------|-------|
| 44701K22 | 18x12x4,5 | 22x13x5 | 0,85 | 0,68 | 23,62 |
| 44701K25 | 20x15,5x5,5 | 25x16,8x6,2 | 1,4 | 0,9 | 34,07 |
| 44701K32 | 26x20x6,5 | 32x21,7x7,2 | 2,7 | 1,7 | 45,83 |
| 44701K36 | 30x22x6,8 | 36x23,6x7,5 | 3,8 | 2,2 | 56,48 |
| 44701K40 | 33x25,7x7,5 | 40x27,2x8,3 | 5,2 | 2,8 | 62,31 |

Square baker

Pirofila quadra
 Quadratische Ofenschale
 Plat four carré
 Plato horno cuadrado

| art. | cm. int. | cm. est. | lt. | Kg. | € |
|----------|---------------|-------------|------|------|-------|
| 44702K18 | 13x13x4,5 | 18x14x5 | 0,66 | 0,55 | 23,62 |
| 44702K21 | 16,3x16,3x5,4 | 21x17,5x6 | 1,1 | 0,8 | 31,66 |
| 44702K28 | 22,5x22,5x6,5 | 28x23,7x7,2 | 2,7 | 1,6 | 41,10 |
| 44702K36 | 29,5x29,5x7,5 | 36x31x8,2 | 5,4 | 2,8 | 57,59 |



Big heart dish

Pirofila cuore
Herz Ofenschale
Plat four cœur
Plato corazón

| art. | cm. int. | cm. est. | lt. | Kg. | Por. | € |
|----------|---------------|-----------|-----|------|------|-------|
| 44711-01 | 25,1x24,3x5,3 | 25,8x25x6 | 1,7 | 1,35 | 4-6 | 38,99 |



Small heart dish, set 2 pcs

Stampo cuore piccolo, set 2 pezzi
Herz-Ofenschale, klein, 2 Stk
Petit plat cœur, set 2 pièces
Plato corazón pequeño, 2 piezas

| art. | cm. int. | cm. est. | lt. | Kg. | Por. | € |
|----------|---------------|---------------|------|------|------|-------|
| 44711-02 | 12,8x12,6x4,1 | 13,4x13,2x4,7 | 0,35 | 0,35 | 1 | 38,99 |

STACKABLE RAMEKINS

NEW





Ramekin, set 2 pcs RED
Stampo ramekin, set 2 pezzi
Pastetenform, 2 Stk
Ramequin, set 2 pièces
Molde ramekin, 2 piezas

| art. | cm. int. | cm. est. | lt. | Kg. | Por. | € |
|----------|-----------|-----------|-----|------|------|-------|
| 44713R02 | 8,3x8,3x5 | 11x11x5,6 | 0,2 | 0,23 | 1 | 19,90 |



Ramekin, set 2 pcs ECRU
Stampo ramekin, set 2 pezzi
Pastetenform, 2 Stk
Ramequin, set 2 pièces
Molde ramekin, 2 piezas

| art. | cm. int. | cm. est. | lt. | Kg. | Por. | € |
|----------|-----------|-----------|-----|------|------|-------|
| 44713C02 | 8,3x8,3x5 | 11x11x5,6 | 0,2 | 0,23 | 1 | 19,90 |



Ramekin, set 2 pcs SLATE
Stampo ramekin, set 2 pezzi
Pastetenform, 2 Stk
Ramequin, set 2 pièces
Molde ramekin, 2 piezas

| art. | cm. int. | cm. est. | lt. | Kg. | Por. | € |
|----------|-----------|-----------|-----|------|------|-------|
| 44713S02 | 8,3x8,3x5 | 11x11x5,6 | 0,2 | 0,23 | 1 | 19,90 |



Ramekin, set 2 pcs SATIN BLACK
Stampo ramekin, set 2 pezzi
Pastetenform, 2 Stk
Ramequin, set 2 pièces
Molde ramekin, 2 piezas

| art. | cm. int. | cm. est. | lt. | Kg. | Por. | € |
|----------|-----------|-----------|-----|------|------|-------|
| 44713K02 | 8,3x8,3x5 | 11x11x5,6 | 0,2 | 0,23 | 1 | 19,90 |

SERIES LIVING

TABLE TOP
TAVOLA



A complete stainless steel line, that is able to join assortment, beauty, strength and functionality. Quality items that can be used in order to set the most charming tables and buffets, but also in order to have a well-equipped kitchen. The easiest way to serve with charm any kind of dishes: from spaghetti to meat, fish, bread, vegetables, cheese and fruit. It is also indicated for tiny preparations such as sweets, olives and pickles. Nothing will unintentionally escape!

Una linea completa capace di coniugare assortimento, bellezza, robustezza e funzionalità, realizzata in acciaio inox. Oggetti di qualità per apparecchiare le tavole ed i buffet più raffinati, ma anche per disporre quotidianamente di una cucina super-attezzata. Il modo più pratico per servire con eleganza e facilità ogni tipo di pietanza dagli spaghetti alla carne, pesce, pane, verdure, formaggi e frutta ma anche piccoli alimenti come dolci, olive e sottaceti. Niente potrà sfuggire inavvertitamente!





Vegetables serving plier

Forbice per verdure
Salad-/Gemüsezange
Pince à légumes
Pinza verduras

| art. | dim. cm. | € |
|----------|----------|-------|
| 12550-81 | 24 | 32,16 |



Serving plier

Forbice tutto servire
Servierzange
Pince à servir
Pinza servir

| art. | dim. cm. | € |
|----------|----------|-------|
| 12550-83 | 21,0 | 19,10 |
| 12550-84 | 26,5 | 30,05 |
| 12550-85 | 24,0 | 24,32 |



Pie plier

Forbice per torta
Kuchenzange
Pince à tarte
Pinza pasteles

| art. | dim. cm. | € |
|----------|----------|-------|
| 12550-80 | 28 | 25,13 |



Hors-d'oeuvres and pastry plier

Forbice per antipasti e dolci
Vorspeisen-/Pâtisseriezange
Pince à hors-d'oeuvres et pâtisserie
Pinza entremeses y pasteles

| art. | dim. cm. | € |
|----------|----------|-------|
| 12550-87 | 15 | 13,77 |
| 12550-89 | 20 | 19,80 |



Pastry plier

Forbice per dolci
Gebäckzange
Pince à pâtisserie
Pinza pasteles

| art. | dim. cm. | € |
|----------|----------|-------|
| 12550-88 | 18 | 17,39 |



Fruit tongs

Molla per frutta
Fruchtenzange
Pince à fruits
Pinza frutas

| art. | dim. cm. | € |
|----------|----------|-------|
| 12550-50 | 23,5 | 16,78 |



Spaghetti tongs

Molla per spaghetti
Spaghettizange
Pince à spaghetti
Pinza espagueti

| art. | dim. cm. | € |
|----------|----------|-------|
| 12550-73 | 21 | 12,86 |
| 12550-74 | 30 | 22,61 |



Toast and pastry tongs

Molla per toast e dolci
Toast-/Gebäckzange
Pince à toast et tarte
Pinza pasteles y tostadas

| art. | dim. cm. | € |
|----------|----------|-------|
| 12550-77 | 21 | 11,56 |
| 12550-78 | 24 | 15,28 |



Multipurpose tongs

Molla universale
Universalzange
Pince universelle
Pinza universal

| art. | dim. cm. | € |
|----------|----------|-------|
| 12550-58 | 30 | 32,16 |



Serving tongs

Molla tutto servire
Servierzange
Pince à servir
Pinza asados y verduras

| art. | dim. cm. | € |
|----------|----------|-------|
| 12550-68 | 21 | 14,17 |
| 12550-69 | 26 | 14,97 |
| 12550-70 | 30 | 24,12 |



Bread and pastry tongs

Molla per pane e pasticceria
Brot-/Gebäckzange
Pince à pain et pâtisserie
Pinza pan y pasteles

| art. | dim. cm. | € |
|----------|----------|-------|
| 12550-62 | 18 | 8,94 |
| 12550-63 | 23 | 16,78 |
| 12550-64 | 26 | 21,61 |



Snail tongs

Molla per lumache
Schneckenzange
Pince à escargots
Pinza caracoles

| art. | dim. cm. | € |
|----------|----------|-------|
| 12550-60 | 17 | 10,35 |



Asparagus tongs

Molla per asparagi
Spargelzange
Pince à asperges
Pinza espárragos

| art. | dim. cm. | € |
|----------|----------|-------|
| 12550-66 | 23 | 14,97 |



Ice tongs

Molla per ghiaccio
Eiszange
Pince à glace
Pinza hielo

| art. | dim. cm. | € |
|----------|----------|------|
| 12550-56 | 17,5 | 8,94 |



Sugar tongs

Molla per zucchero
Zuckerzange
Pince à sucre
Pinza azúcar

| art. | dim. cm. | € |
|----------|----------|------|
| 12550-53 | 12 | 6,33 |



Sugar tongs

Molla per zucchero
Zuckerzange
Pince à sucre
Pinza azúcar

| art. | dim. cm. | € |
|----------|----------|------|
| 12550-54 | 12,5 | 6,33 |



Ice tongs

Molla per ghiaccio
Eiszange
Pince à glace
Pinza hielo

| art. | dim. cm. | € |
|----------|----------|-------|
| 12550-55 | 18,5 | 10,35 |



Panettone knife

Coltello panettone
Tortenmesser
Couteau à gâteau
Cuchillo tarta

| art. | dim. cm. | € |
|----------|----------|-------|
| 12550-34 | 32 | 28,04 |



Cake server

Pala torta
Tortenheber
Pelle à gâteau
Pala tarta

| art. | dim. cm. | € |
|----------|----------|-------|
| 12550-02 | 30 | 22,71 |



Serving fork

Forchetta a servire
Serviergabel
Fourchette à servir
Tenedor servir

| art. | dim. cm. | € |
|----------|----------|-------|
| 12550-11 | 29,5 | 17,69 |
| 12550-12 | 26,0 | 14,87 |



Serving spoon

Cucchiaio a servire
Servierlöffel
Cuiller à servir
Cuchara servir

| art. | dim. cm. | € |
|----------|----------|-------|
| 12550-13 | 30,0 | 18,09 |
| 12550-14 | 25,5 | 14,87 |
| 12550-22 | 39,0 | 26,13 |





Serving spoon perforated

Cucchiaio a servire forato
Servierlöffel, perforiert
Cuiller à servir perforée
Cuchara servir, perforada

| art. | dim. cm. | € |
|----------|----------|-------|
| 12550-25 | 25,5 | 17,49 |
| 12550-26 | 30,0 | 20,10 |



Ladle

Mestolo
Schöpfer
Louche
Cazo

| art. | dim. cm. | € |
|----------|----------|-------|
| 12550-01 | 25,5 | 20,10 |



Sauce ladle

Coppino salsa
Dressingschöpfer
Louche à sauce
Cazillo salsas

| art. | dim. cm. | € |
|----------|----------|------|
| 12550-20 | 16 | 9,95 |



Perforated sauce ladle

Coppino forato
Dressingschöpfer, gelocht
Louche à sauce percée
Cazillo, perforado

| art. | dim. cm. | € |
|----------|----------|-------|
| 12550-21 | 16,5 | 11,76 |



Spaghetti serving fork

Forchettone spaghetti
Spaghettivorlegegabel
Fourchette à servir spaghetti
Tenedor servir espagueti

| art. | dim. cm. | € |
|----------|----------|-------|
| 12550-15 | 28,5 | 20,90 |



Rice ladle

Cucchiaio risotto
Reislöffel
Cuiller à risotto
Cuchara arroz

| art. | dim. cm. | € |
|----------|----------|-------|
| 12550-16 | 28 | 19,30 |



Meat fork

Forchettone
Tranchiergabel
Fourchette
Tenedor

| art. | dim. cm. | € |
|----------|----------|-------|
| 12550-30 | 32 | 25,93 |



Roast beef knife

Coltello arrosto
Tranchiermesser
Couteau à rôtis
Cuchillo roastbeef

| art. | dim. cm. | € |
|----------|----------|-------|
| 12550-33 | 32 | 27,54 |



Salt spoon

Cucchiaino sale
Salzlöffel
Cuiller à sel
Cucharita para sal

| art. | dim. cm. | U. Pack | € |
|----------|----------|---------|------|
| 12550-17 | 6,5 | 6 | 4,22 |



Ice tea spoon

Cucchiaio bibita
Limonadenlöffel
Cuillère à soda
Cuchara refresco

| art. | dim. cm. | U. Pack | € |
|----------|----------|---------|------|
| 12550-36 | 19,5 | 6 | 5,33 |



Oyster fork

Forchettina ostriche
Austerngabel
Fourchette à huîtres
Tenedor ostras

| art. | dim. cm. | U. Pack | € |
|----------|----------|---------|------|
| 12550-43 | 14 | 6 | 6,03 |



Escargot fork

Forchetta per lumache
Schnecken gabel
Fourchette à escargots
Tenedor caracoles

| art. | dim. cm. | U. Pack | € |
|----------|----------|---------|------|
| 12550-19 | 14 | 6 | 3,62 |



Ice spoon

Cucchiaio ghiaccio
Eislöffel
Cuillère à glace
Cuchara hielo

| art. | dim. cm. | € |
|----------|----------|------|
| 12550-04 | 22 | 9,25 |



Dressing spoon

Cucchiaio salsa
Saucenlöffel
Cuillère à sauce
Cuchara salsa

| art. | dim. cm. | € |
|----------|----------|------|
| 12550-06 | 22 | 8,84 |



Monoportion spoon

Cucchiaio monoporzione
Monoporzion-Löffel
Cuillère monoportion
Cuchara monoporción

| art. | dim. cm. | U. Pack | € |
|----------|----------|---------|------|
| 12550-03 | 9,5 | 6 | 5,93 |
| 12550-07 | 12,0 | 6 | 8,14 |



Monoportion fork

Forchetta monoporzione
Monoporzion-Gabel
Fourchette monoportion
Tenedor monoporción

| art. | dim. cm. | U. Pack | € |
|----------|----------|---------|------|
| 12550-05 | 9,5 | 6 | 5,93 |



Monoportion fork

Forchetta monoporzione
Monoporzion-Gabel
Fourchette monoportion
Tenedor monoporción

| art. | dim. cm. | U. Pack | € |
|----------|----------|---------|------|
| 12550-09 | 12 | 6 | 8,14 |



DISPLAY & PRESENTATION

BUFFET





MF

Square bowl

Ciotola quadra
Schüssel, quadratisch
Bol carré
Cuenco cuadrado

| art. | dim. cm. | col. | € |
|----------|---------------|------|-------|
| 44847B09 | 9x9x4 | ● | 3,62 |
| 44847B13 | 12,5x12,5x6,5 | ● | 9,05 |
| 44847B20 | 19x19x9 | ● | 21,41 |
| 44847-09 | 9x9x4 | ○ | 3,62 |
| 44847-13 | 12,5x12,5x6,5 | ○ | 9,05 |
| 44847-20 | 19x19x9 | ○ | 21,41 |



MF

Round bowl

Ciotola tonda
Schüssel, rund
Bol ronde
Cuenco redondo

| art. | Ø cm. | h. cm. | col. | € |
|----------|-------|--------|------|------|
| 44846B05 | 5,5 | 4,0 | ● | 1,51 |
| 44846B09 | 9,0 | 4,5 | ● | 3,12 |
| 44846B13 | 13,0 | 6,5 | ● | 7,84 |
| 44846-05 | 5,5 | 4,0 | ○ | 1,51 |
| 44846-09 | 9,0 | 4,5 | ○ | 3,12 |
| 44846-13 | 13,0 | 6,5 | ○ | 7,84 |



MF

Party plate

Piattino fingerfood
Fingerfood-Teller
Petit assiette
Platillo

| art. | dim. cm. | col. | € |
|----------|-------------|------|------|
| 44844-01 | 9,5x9,5x1,5 | ○ | 6,73 |
| 44844B01 | 9,5x9,5x1,5 | ● | 6,73 |





MF

Tray, square

Vassoio quadro
Tablett, quadratisch
Plateau carré
Bandeja, cuadrada

| art. | dim. cm. | € |
|----------|-----------|-------|
| 44841-18 | 18x18 | 10,85 |
| 44841-21 | 21x21 | 16,68 |
| 44841-26 | 26,5x26,5 | 21,41 |
| 44841-37 | 37x37 | 35,78 |
| 44841-51 | 51x51 | 69,95 |



MF

Tray, square

Vassoio quadro
Tablett, quadratisch
Plateau carré
Bandeja, cuadrada

| art. | dim. cm. | € |
|----------|----------|-------|
| 44841B51 | 51x51 | 69,95 |



MF

Sushi tray

Vassoio sushi
Sushiplatte
Plateau sushi
Bandeja sushi

| art. | dim. cm. | € |
|----------|----------|-------|
| 44842B31 | 31x10,5 | 6,33 |
| 44842B53 | 53x18 | 31,46 |



MF

Sushi tray

Vassoio sushi
Sushiplatte
Plateau sushi
Bandeja sushi

| art. | dim. cm. | € |
|----------|----------|-------|
| 44842-31 | 31x10,5 | 6,33 |
| 44842-35 | 35,5x18 | 20,10 |
| 44842-30 | 30x21 | 22,41 |
| 44842-53 | 53x18 | 31,46 |



MF

Tray

Vassoio
Tablett
Plateau
Bandeja

| art. | dim. cm. | GN | € |
|----------|-----------|-----|-------|
| 44843-11 | 53x32,5 | 1/1 | 47,54 |
| 44843-12 | 32,5x26,5 | 1/2 | 30,95 |
| 44843-24 | 53x16,2 | 2/4 | 28,34 |
| 44843-13 | 32,5x17,5 | 1/3 | 18,99 |
| 44843-14 | 26,5x16,2 | 1/4 | 16,08 |



MF

Tray

Vassoio
Tablett
Plateau
Bandeja

| art. | dim. cm. | GN | € |
|----------|-----------|-----|-------|
| 44843B11 | 53x32,5 | 1/1 | 47,54 |
| 44843B12 | 32,5x26,5 | 1/2 | 30,95 |
| 44843B24 | 53x16,2 | 2/4 | 28,34 |
| 44843B13 | 32,5x17,5 | 1/3 | 18,99 |
| 44843B14 | 26,5x16,2 | 1/4 | 16,08 |



MF

Round dish

Piatto tondo
Platte, rund
Plat rond
Bandeja redonda

| art. | Ø cm. | € |
|----------|-------|-------|
| 44845-30 | 30 | 15,98 |
| 44845-38 | 38 | 25,02 |
| 44845-41 | 41 | 28,14 |
| 44845-51 | 51 | 43,82 |



SAN

Roll-top cover

Coperchio roll-top
Rolltophaube
Couvercle roll-top
Campana roll-top

| art. | Ø cm. | h. cm. | fits/per | € |
|----------|-------|--------|----------|-------|
| 41447-38 | 38 | 20 | 44846-38 | 40,50 |



MF

Bowl

Ciotola
Schale
Bol
Cuenco

| art. | Ø cm. | h. cm. | ml. | € |
|----------|-------|--------|-----|------|
| 44466-07 | 7 | 6 | 50 | 4,42 |



MF

Bowl

Ciotola
Schale
Bol
Cuenco

| art. | dim. cm. | lt. | € |
|----------|-----------|------|------|
| 44466-11 | 7,5x7x4,5 | 0,05 | 3,52 |



MF

Bowl

Ciotola
Schale
Bol
Cuenco

| art. | dim. cm. | lt. | € |
|----------|------------|------|------|
| 44466-12 | 11,5x7,5x3 | 0,06 | 3,52 |



MF

Bowl

Ciotola
Schale
Bol
Cuenco

| art. | dim. cm. | lt. | € |
|----------|------------|------|------|
| 44466-13 | 11,5x6x5,5 | 0,04 | 3,52 |



MF

Bowl

Ciotola
Schale
Bol
Cuenco

| art. | dim. cm. | lt. | € |
|----------|----------|------|------|
| 44466-14 | 8,5x7x6 | 0,07 | 3,52 |



MF

Bowl

Ciotola
Schale
Bol
Cuenco

| art. | dim. cm. | lt. | € |
|----------|----------|-----|------|
| 44466-15 | 8x8x4 | 0,1 | 3,52 |



MF

Bowl

Ciotola
Schale
Bol
Cuenco

| art. | dim. cm. | lt. | € |
|----------|----------|-----|------|
| 44466-16 | 35x4,5x3 | 0,2 | 5,53 |



MF

Party spoon

Cucchiaio finger-food
Finger-food-Löffel
Cuiller
Cucharita

| art. | dim. cm. | col. | € |
|----------|----------|------|------|
| 44850-11 | 11x4,3 | ○ | 2,31 |



MF

Party spoon

Cucchiaio finger-food
Finger-food-Löffel
Cuiller
Cucharita

| art. | dim. cm. | col. | € |
|----------|----------|------|------|
| 44850B11 | 10x4,5 | ● | 2,31 |



MF

Party spoon

Cucchiaio finger-food
Finger-food-Löffel
Cuiller
Cucharita

| art. | dim. cm. | col. | € |
|----------|----------|------|------|
| 44850-13 | 13,5x4,5 | ○ | 1,01 |





MF

Party spoon
Cucchiaio finger-food
Finger-food-Löffel
Cuiller
Cucharita

| art. | dim. cm. | col. | € |
|----------|----------|------|------|
| 44850B13 | 13,5x4,5 | ● | 1,01 |



MF

Party spoon
Cucchiaio finger-food
Finger-food-Löffel
Cuiller
Cucharita

| art. | dim. cm. | col. | € |
|----------|----------|------|------|
| 44850-12 | 10x4,5x1 | ○ | 3,72 |



MF

Party spoon
Cucchiaio finger-food
Finger-food-Löffel
Cuiller
Cucharita

| art. | dim. cm. | col. | € |
|----------|----------|------|------|
| 44850B12 | 10x4,5x1 | ● | 3,72 |



MF

Party spoon
Cucchiaio finger-food
Finger-food-Löffel
Cuiller
Cucharita

| art. | dim. cm. | col. | € |
|----------|----------|------|------|
| 44850G12 | 10x4,5x1 | ● | 3,72 |



MF

Party spoon
Cucchiaio finger-food
Finger-food-Löffel
Cuiller
Cucharita

| art. | dim. cm. | € |
|----------|----------|------|
| 44851-01 | 14,5x4,5 | 6,23 |



PVD

SS

Party spoon
Cucchiaio gourmet
Gourmet-Löffel
Cuiller gourmet
Cuchara gourmet

| art. | dim. cm. | U. Pack | col. | € |
|----------|--------------|---------|------|------|
| 42988-99 | 13,5x4,5x4,5 | 6 | ● | 3,52 |
| 42988C99 | 13,5x4,5x4,5 | 6 | ● | 4,52 |
| 42988G99 | 13,5x4,5x4,5 | 6 | ● | 4,52 |



FINE MELAMINE SERIES EASY



Withstands temperatures from -20°C to +70°C.

Termoresistenti da -20°C a +70°C.



Serving board

Tagliere
Servier-Brett
Planche
Tabla

| art. | Ø cm. | h. cm. | € |
|----------|-------|--------|-------|
| 44470-30 | 30 | 1 | 21,00 |
| 44470-40 | 40 | 1 | 37,59 |



Platter

Plancia
Tablett
Plateau
Bandeja

| art. | dim. cm. | GN | € |
|----------|-------------|-----|-------|
| 44470-11 | 53,0x32,5x1 | 1/1 | 49,95 |
| 44470-24 | 53,0x16,2x1 | 2/4 | 25,23 |
| 44470-12 | 32,5x26,5x1 | 1/2 | 18,99 |
| 44470-13 | 32,5x17,5x1 | 1/3 | 11,96 |
| 44470-14 | 26,5x16,5x1 | 1/4 | 10,05 |



Platter

Plancia
Tablett
Plateau
Bandeja

| art. | dim. cm. | € |
|----------|----------|-------|
| 44470-73 | 20x10x2 | 7,74 |
| 44470-74 | 30x10x2 | 12,66 |
| 44470-75 | 30x15x2 | 18,79 |



Bowl

Ciotola
Schüssel
Bol
Bol Ensalada

| art. | dim. cm. | lt. | € |
|----------|----------|-----|-------|
| 44470-03 | 19x19x9 | 1,5 | 20,50 |
| 44470-04 | 25x25x12 | 3,8 | 46,43 |



Cake/cheese tray

Piatto torta/formaggi
Kuchen/Käseplatte
Plat gâteau/fromage
Bandeja pasteles/queso

| art. | Ø cm. | h. cm. | € |
|----------|-------|--------|-------|
| 44470-22 | 21,5 | 2,5 | 26,33 |
| 44470-31 | 30,5 | 3,5 | 37,79 |
| 44470-38 | 37,5 | 4,0 | 70,85 |

With non-slip feet. With carved edge fixing the cover. – Con piedini antiscivolo. Con bordo fissa-coperchio.



Dome cover

Campana
Haube
Cloche
Campana

| art. | dim. cm. | fits/per | € |
|----------|----------|----------|-------|
| 41414-21 | 21x17 | 44470-22 | 21,61 |
| 41414-31 | 30x22 | 44470-31 | 42,71 |
| 41414-36 | 36x27 | 44470-38 | 71,96 |

PC





Ciotola
Schüssel
Bol
Cuenco

| art. | Ø cm. | h. cm. | lt. | € |
|----------|-------|--------|-----|-------|
| 44860-21 | 21 | 8,5 | 1,8 | 54,77 |
| 44860-25 | 25 | 8,5 | 2,5 | 62,61 |
| 44860-27 | 27 | 8,5 | 3,0 | 70,45 |

Acacia wood.



Bowl
Ciotola
Schüssel
Bol
Cuenco

| art. | Ø cm. | h. cm. | lt. | € |
|----------|-------|--------|-----|-------|
| 41446-18 | 18 | 9,5 | 1,0 | 40,50 |
| 41446-23 | 23 | 12,5 | 2,2 | 53,97 |

Concrete. – Cemento.



Bowl
Ciotola
Schüssel
Bol
Cuenco

| art. | Ø cm. | h. cm. | lt. | € |
|----------|-------|--------|-----|-------|
| 41445-22 | 22,0 | 10,5 | 1,1 | 40,50 |
| 41445-26 | 26,0 | 13,0 | 1,7 | 50,65 |
| 41445-30 | 29,5 | 14,5 | 2,5 | 60,80 |

Concrete. – Cemento.





W

Stand

Alzata
Ständer
Support
Soporte

| art. | Ø cm. | h. cm. | € |
|----------|-------|--------|-------|
| 41445-01 | 15 | 10 | 28,64 |
| 41445-02 | 35 | 15 | 35,48 |

Acacia wood. – Fig. bowls/ciotole 41445-22/26/30.



W

Stand

Alzata
Ständer
Support
Soporte

| art. | Ø cm. | h. cm. | € |
|----------|-------|--------|-------|
| 41445-05 | 20 | 10,5 | 46,83 |
| 41445-06 | 30,5 | 15 | 82,41 |
| 41445-07 | 30,5 | 20 | 88,84 |

Acacia wood.



PC

Cover

Coperchio
Deckel
Couvercle
Tapa

| art. | Ø cm. | h. cm. | € |
|----------|-------|--------|-------|
| 41414-31 | 30 | 22 | 42,71 |

Fits to / Per art: 41445-06/07.



W

Stand

Alzata
Ständer
Support
Soporte

| art. | dim. cm. | € |
|----------|------------|-------|
| 41445-09 | 53x16,2x20 | 96,88 |

Acacia wood.



PC

Cover

Coperchio
Deckel
Couvercle
Tapa

| art. | dim. cm. | GN | € |
|----------|--------------|-----|-------|
| 41420-24 | 53x16,2x10,5 | 2/4 | 37,19 |

Fits to /Per art: 41445-09.





W

Buffet stand
Espositore buffet
Buffetgestell
Présentoir
Expositor de buffet

| art. | dim. cm. | € |
|----------|----------|--------|
| 42460-53 | 53x21x50 | 244,62 |

Shelves/Ripiani: 30 x 15 - 40 x 17,5 - 53 x 19 cm.



W

Buffet stand
Espositore buffet
Buffetgestell
Présentoir
Expositor de buffet

| art. | dim. cm. | € |
|----------|----------|--------|
| 42470-53 | 53x21x50 | 244,62 |

Shelves/Ripiani: 30 x 15 - 40 x 17,5 - 53 x 19 cm.



W
AR

Serving stand 2-tier
Alzata 2 piani
Servierstand 2-stufig
Support 2 niveaux
Soporte 2 pisos

| art. | dim. cm. | € |
|----------|-------------|-------|
| 41207-02 | 25x4,5x34,5 | 39,80 |

Beech. Slate cm. 31x13 - 41x18.
Faggio. Ardesia cm. 31x13 - 41x18.



W
AR

Serving stand 3-tier
Alzata 3 piani
Servierstand 3-stufig
Support 3 niveaux
Soporte 3 pisos

| art. | dim. cm. | € |
|----------|-----------|-------|
| 41207-03 | 25x4,5x54 | 44,92 |

Beech. Slate cm. 21x8 - 31x13 - 41x18.
Faggio. Ardesia cm. 21x8 - 31x13 - 41x18.



W

Stand
Alzata
Ständer
Support
Soporte

| art. | dim. cm. | € |
|----------|------------|-------|
| 42463A00 | 20x20x17,5 | 19,90 |

Acacia wood.



W

Stand
Alzata
Ständer
Support
Soporte

| art. | dim. cm. | € |
|----------|------------|-------|
| 42463B00 | 20x20x17,5 | 19,90 |

Acacia wood.



FE

Stand
Alzata
Ständer
Support
Soporte

| art. | Ø cm. | h. cm. | € |
|----------|---------|--------|-------|
| 44840-40 | 15,5-18 | 8 | 18,39 |
| 44840-41 | 15,5-18 | 10 | 21,91 |
| 44840-42 | 15,5-18 | 18 | 28,24 |

Black anti-slide coating.
Rivestimento antiscivolo nero.

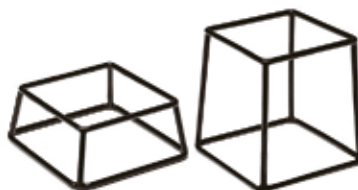

FE

Stand
Alzata
Ständer
Support
Soporte

| art. | dim. cm. | € |
|----------|----------|-------|
| 44840-08 | 18x18x8 | 22,21 |
| 44840-10 | 18x18x10 | 26,93 |
| 44840-18 | 18x18x18 | 31,86 |

Black anti-slide coating.
Rivestimento antiscivolo nero.



FE

Stand
Alzata
Ständer
Support
Soporte

| art. | h. cm. | € |
|----------|--------|-------|
| 44840-30 | 8 | 25,02 |
| 44840-31 | 12 | 29,55 |
| 44840-32 | 18 | 33,77 |

Black anti-slide coating.
Rivestimento antiscivolo nero.



Stand chromed
Alzata cromata
Ständer, verchromt
Support chromé
Soporte cromado

| art. | GN | € |
|----------|---------|-------|
| 44840-50 | 1/1-2/4 | 60,80 |
| 44840-51 | 1/2-1/4 | 38,19 |
| 44840-52 | 1/3-2/3 | 48,94 |

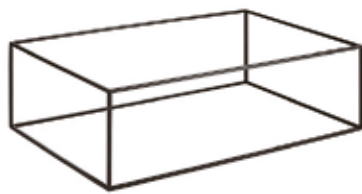

Stand
Alzata
Ständer
Support
Soporte

| art. | GN | € |
|----------|---------|-------|
| 44840-55 | 1/1-2/4 | 50,45 |
| 44840-56 | 1/2-1/4 | 30,05 |
| 44840-57 | 1/3-2/3 | 38,49 |

Black coating. – Rivestimento nero.



Tray
Vassoio
Tablett
Plateau
Bandeja

| art. | dim. cm. | GN | € |
|----------|-------------|-----|-------|
| 44477-76 | 53x32,5x3 | 1/1 | 69,85 |
| 44477-77 | 32,5x26,5x3 | 1/2 | 38,79 |
| 44477-78 | 32,5x17,6x3 | 1/3 | 28,84 |
| 44477-79 | 26,5x16,2x3 | 1/4 | 22,71 |
| 44477-80 | 35,4x32,5x3 | 2/3 | 50,15 |
| 44477-81 | 53x16,2x3 | 2/4 | 45,23 |



Cutting board
Tagliere
Schneidebrett
Planche à découper
Table de corte

| art. | dim. cm. | € |
|----------|---------------|--------|
| 44840-54 | 35,4x32,5x3,5 | 129,95 |

Walnut/Noce. Fits stands/Per supporti 44840-52 & 44840-57.



Drawer with black handle
Cassetto con pomolo nero
Schublade, schwarzer Griff
Tiroir poignée noire
Cajón con pomo negro

| art. | dim. cm. | € |
|----------|------------|--------|
| 44840-58 | 34x32x17,5 | 138,39 |

Fits stand 44840-57. – Per supporto 44840-57.



Stand/basket
Alzata/cesto
Ständer/Korb
Support/panier
Soporte/cesta

| art. | Ø cm. | h. cm. | col. | € |
|----------|--------|--------|------|-------|
| 44476-52 | 10,5-8 | 8 | ● | 27,64 |



Stand/basket
Alzata/cesto
Ständer/Korb
Support/panier
Soporte/cesta

| art. | Ø cm. | h. cm. | col. | € |
|----------|--------|--------|------|-------|
| 44476-53 | 10,5-8 | 8 | ● | 25,33 |





FE



Stand/basket

Alzata/cesto
Ständer/Korb
Support/panier
Soporte/cesta

| art. | Ø cm. | h. cm. | col. | € |
|----------|--------|--------|------|-------|
| 44476-51 | 10,5-8 | 8 | ● | 27,64 |



FE

Stand/basket chromed

Alzata/cesto cromato
Ständer/Korb, verchromt
Support/panier, chromé
Soporte/cesta cromado

| art. | Ø cm. | h. cm. | € |
|----------|-------|--------|-------|
| 44476-30 | 15 | 10,5 | 45,23 |
| 44476-31 | 21 | 20,0 | 73,77 |



SS

Fruit stand, 3 tiers

Alzata frutta, 3 piani
Obständer, 3-stöckig
Etagère à fruits, 3 étages
Frutero 3 pisos

| art. | Ø cm. | h. cm. | € |
|----------|----------|--------|--------|
| 42940-03 | 32-38-48 | 50 | 176,98 |



PMMA

Buffet display

Display per buffet
Büffetgestell
Etagère à buffet
Expositor para buffet

| art. | dim. cm. | € |
|----------|----------|--------|
| 41870-01 | 54x47x63 | 368,13 |

Shelves/Ripiani:
47x34 - 37x25 - 27x17 - 23x13 cm.

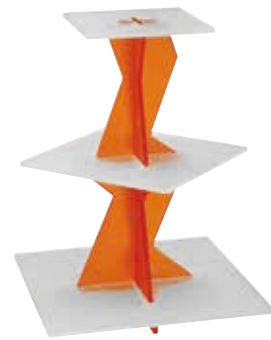

PMMA

Buffet display

Display per buffet
Büffetgestell
Etagère à buffet
Expositor para buffet

| art. | dim. cm. | € |
|----------|----------|---|
| 41870-02 | 40x40x53 | - |

Shelves/Ripiani:
40x40 - 30x30 - 22x22 - 27x17 - 23x13 cm.



PMMA

Buffet display

Display per buffet
Büffetgestell
Etagère à buffet
Expositor para buffet

| art. | Ø cm. | h. cm. | € |
|----------|-------|--------|---|
| 41870-03 | 28 | 29 | - |

Shelves/Ripiani:
38x30x21 - 38x30x13 - 38x30x5 cm.



PMMA

Buffet display

Display per buffet
Büffetgestell
Etagère à buffet
Expositor para buffet

| art. | dim. cm. | € |
|----------|----------|--------|
| 41870-04 | 40x27x29 | 434,46 |

Shelves/Ripiani:
40x27x21 - 40x27x13 - 40x27x5 cm.



Wedding cake stand, aluminum

Alzata per torte, alluminio
Hochzeitstortenständer, Aluminium
Support pour tourte de mariage, alu
Pedestal para tartas, aluminio

| art. | Ø cm. | € |
|----------|----------------|--------|
| 47100-03 | 20-26-32 | 87,74 |
| 47100-04 | 20-26-32-40 | 125,02 |
| 47100-05 | 20-26-32-40-45 | 184,82 |

Distance between tiers 16,5 cm.
Distanziali h. 16,5 cm.



Wedding cake stand, aluminum

Alzata per torte, alluminio
Hochzeitstortenständer, Aluminium
Support pour tourte de mariage, alu
Pedestal para tartas, aluminio

| art. | Ø cm. | € |
|----------|-------------------------|--------|
| 47100-06 | 20-26-32-40-45-50 | 234,47 |
| 47100-07 | 16-20-26-32-40-45-50 | 263,31 |
| 47100-08 | 16-20-26-32-40-45-50-55 | 309,94 |

Distance between tiers 16,5 cm.
Distanziali h. 16,5 cm.



Lighting column (seafood tray base)

Colonna luminosa (base vassoio frutti mare)
Lichtsäule (Meeresfrüchten-Schale-Basis)
Socle lumineux (à plateau fruit de mer)
Columna luminosa (base bandeja mariscos)

| art. | Ø cm. | h. cm. | € |
|----------|-------|--------|--------|
| 42979-00 | 30 | 21 | 189,44 |

Stainless steel base plate ø 30 cm., PMMA column, LED-light box and remote control.
Base inox ø cm 30, colonna PMMA, scatola luci-LED con telecomando.



Oyster plate

Piatto frutti di mare
Austernplatte
Plat à huîtres
Fuente de mariscos

| art. | Ø cm. | h. cm. | € |
|----------|-------|--------|-------|
| 42979-36 | 36 | 4,5 | 52,96 |

The plate has a centering element which keeps it anchored to the column.



Oyster plate

Piatto frutti di mare
Austernplatte
Plat à huîtres
Fuente de mariscos

| art. | Ø cm. | h. cm. | € |
|----------|-------|--------|-------|
| 42979-45 | 45 | 5,5 | 73,47 |

Sotto il piatto è fissato un elemento di centraggio che lo mantiene ancorato alla colonna luminosa.



Chocolate fountain

Fontana cioccolato
Schokoladenbrunnen
Fontaine à chocolat
Fuente para chocolate

| art. | Ø cm. | h. cm. | lt. | W | € |
|----------|-------|--------|-----|-----|----------|
| 42982-08 | 38 | 80 | 3,5 | 370 | 1.452,33 |

230V-50Hz-Amps 1,6A. Minimum quantity of chocolate necessary for operation is about 3.5 kg, the maximum is 8 kg. – Quantità minima di cioccolato richiesta per funzionare è di circa 3,5 kg e può contenerne fino a 8 kg.



Cocktail fountain

Fontana cocktails
Cocktails-Laufbrunnen
Fontaine à cocktails
Fuente cocktail

| art. | Ø cm. | h. cm. | lt. | € |
|----------|-------|--------|-----|----------|
| 42981-73 | 42 | 56 | 15 | 2.864,65 |

10W 220V. NOT recommend for use with fizzy drinks or champagne. – Prodotto NON consigliato per liquidi gasati o champagne.



SS

SS



SS

Punch bowl

Coppa punch
Punchbowle
Rafraîchisseur
Cubitera para champán

| art. | Ø cm. | lt. | € |
|----------|-------|------|--------|
| 11956-37 | 36 | 9,5 | 121,71 |
| 11956-42 | 42 | 15,0 | 159,80 |



PC

Punch bowl

Coppa punch
Punchbowle
Rafraîchisseur
Cubitera para champán

| art. | Ø cm. | lt. | € |
|----------|-------|-----|--------|
| 41541-44 | 44 | 15 | 145,32 |

Stainless steel bottom ring. – Piede inox.



AY

Bottle cooler

Spumantiera
Flaschenkühler
Rafraîchisseur à bouteilles
Cubitera

| art. | dim. cm. | € |
|----------|------------|-------|
| 44946-40 | 40,5x30x25 | 47,13 |



AY

Party tub

Secchio portabottiglie
Flaschenkühler-Bowle
Rafraîchisseur à bouteilles
Cubitera enfriador de botellas

| art. | dim. cm. | € |
|----------|----------|---|
| 44946-04 | 40x28x23 | - |



AY

Party tub

Secchio portabottiglie
Flaschenkühler-Bowle
Rafraîchisseur à bouteilles
Cubitera enfriador de botellas

| art. | dim. cm. | € |
|----------|----------|-------|
| 44946B05 | 35x35x20 | 44,12 |



NEW



Party tub metal look

Secchio portabottiglie
Flaschenkühler-Bowle
Rafraîchisseur à bouteilles
Cubitera enfriador de botellas

| art. | dim. cm. | lt. | € |
|----------|----------|-----|-------|
| 41506-11 | 40x28x22 | 11 | 46,93 |

Galvanized metal with PVC insert.
Metallo galvanizzato con inserto PVC.



NEW



Party tub black metal look

Secchio portabottiglie
Flaschenkühler-Bowle
Rafraîchisseur à bouteilles
Cubitera enfriador de botellas

| art. | dim. cm. | lt. | € |
|----------|----------|-----|-------|
| 41506B11 | 40x28x22 | 11 | 48,54 |

Galvanized metal with PVC insert.
Metallo galvanizzato con inserto PVC.



NEW



Party tub copper look

Secchio portabottiglie
Flaschenkühler-Bowle
Rafraîchisseur à bouteilles
Cubitera enfriador de botellas

| art. | dim. cm. | lt. | € |
|----------|----------|-----|-------|
| 41506C11 | 40x28x22 | 11 | 56,38 |

Galvanized metal with PVC insert.
Metallo galvanizzato con inserto PVC.

STAINLESS STEEL TRAYS
VASSOI INOX





Tray, oval
Vassoio ovale
Tablett, oval
Plateau ovale
Bandeja oval

| art. | dim. cm. | € |
|----------|----------|--------|
| 66325-30 | 30x19 | 24,82 |
| 66325-35 | 35x22 | 28,64 |
| 66325-41 | 41x26 | 33,27 |
| 66325-46 | 46x29 | 37,29 |
| 66325-54 | 54x37 | 52,86 |
| 66325-85 | 85x58 | 302,10 |
| 66325-99 | 100x68 | 391,35 |



Tray, rectangular
Vassoio rettangolare
Serviertablett, rechteckig
Plateau rectangulaire
Bandeja rectangular

| art. | dim. cm. | € |
|----------|----------|--------|
| 66320-28 | 28x20 | 25,13 |
| 66320-35 | 35x30 | 32,76 |
| 66320-40 | 40x26 | 33,87 |
| 66320-50 | 50x38 | 64,62 |
| 66320-65 | 65x50 | 116,68 |
| 66320-85 | 85x50 | 362,40 |
| 66320-99 | 100x50 | 431,55 |



Tray, rectangular
Vassoio rettangolare
Serviertablett, rechteckig
Plateau rectangulaire
Bandeja rectangular

| art. | dim. cm. | € |
|----------|----------|--------|
| 66324-40 | 40x26 | 54,57 |
| 66324-50 | 50x38 | 82,41 |
| 66324-65 | 65x50 | 138,49 |
| 66324-85 | 85x50 | 400,89 |
| 66324-99 | 100x50 | 529,53 |



Tray, oval
Vassoio ovale
Tablett, oval
Plateau ovale
Bandeja oval

| art. | dim. cm. | € |
|----------|----------|-------|
| 41651-20 | 20x14 | 11,56 |
| 41651-25 | 25x18 | 13,97 |
| 41651-30 | 30x22 | 16,48 |
| 41651-35 | 35x22 | 18,99 |
| 41651-40 | 40x26 | 28,94 |



Tray, oval
Vassoio ovale
Tablett, oval
Plateau ovale
Bandeja oval

| art. | dim. cm. | € |
|----------|----------|-------|
| 41651-45 | 45x29 | 35,28 |
| 41651-50 | 50x35 | 49,14 |
| 41651-55 | 55x38 | 63,82 |
| 41651-60 | 60x42 | 67,74 |
| 41651-65 | 65x45 | 83,92 |



Tray, round
Vassoio tondo
Tablett, rund
Plateau rond
Bandeja redonda

| art. | Ø cm. | € |
|----------|-------|--------|
| 66326-30 | 30 | 30,35 |
| 66326-35 | 35 | 34,27 |
| 66326-40 | 40 | 39,60 |
| 66326-60 | 60 | 160,80 |
| 66326-80 | 80 | 356,88 |



Fish tray
Vassoio pesce
Fischplatte
Plat à poisson
Salmonera

| art. | dim. cm. | € |
|----------|----------|-------|
| 66345-55 | 55x23 | 37,79 |
| 66345-65 | 65x27 | 50,25 |
| 66345-74 | 74x29 | 58,79 |



Fish tray
Vassoio pesce
Fischplatte
Plat à poisson
Salmonera

| art. | dim. cm. | € |
|----------|----------|--------|
| 41654-80 | 80x31 | 136,68 |
| 41654-99 | 100x35 | 174,67 |



Tray
Vassoio
Tablett
Plateau
Bandeja

| art. | dim. cm. | GN | € |
|----------|-----------|-----|-------|
| 41436-11 | 53x32,5 | 1/1 | 52,26 |
| 41436-12 | 32,5x26,5 | 1/2 | 30,05 |





Tray
Vassoio
Tablett
Plateau
Bandeja

| art. | dim. cm. | GN | € |
|----------|-----------|-----|---|
| 41430-11 | 53x32,5x5 | 1/1 | - |

Chrome plated handles. Useful height 4 cm.
Maniglie cromate. Altezza utile 4 cm.



Tray stand, chromed
Stand per vassoio, cromato
Tablett-Träger, verchromt
Porte plateaux, chromé
Soporte para bandejas, cromado

| art. | dim. cm. | € |
|----------|-----------|-------|
| 44093-00 | 38x 48x74 | 94,97 |



Tray stand
Stand per vassoio
Tablett-Träger
Porte plateaux
Soporte para bandejas

| art. | dim. cm. | € |
|----------|----------|-------|
| 44093-01 | 42x43x82 | 81,00 |



Non-slip tray, round
Vassoio antiscivolo, rotondo
Tablett, rutschfest, rund
Plateau antidérapant, rond
Bandeja antideslizante, redonda

| art. | Ø cm. | € |
|----------|-------|------|
| 41863-35 | 35 | 4,22 |



Non-slip tray, oval
Vassoio antiscivolo, ovale
Tablett, rutschfest, oval
Plateau antidérapant, ovale
Bandeja antideslizante, oval

| art. | dim. cm. | € |
|----------|----------|-------|
| 41864-56 | 56x68 | 16,18 |



Non-slip tray, rectangular
Vassoio antiscivolo, rettangolare
Tablett, rutschfest, rechteckig
Plateau antidérapant, rectangulaire
Bandeja antideslizante, rectangular

| art. | dim. cm. | € |
|----------|----------|-------|
| 41865-40 | 41x56,5 | 11,16 |



ACRYLIC MIRRORS
SPECCHI ACRILICI PMMA

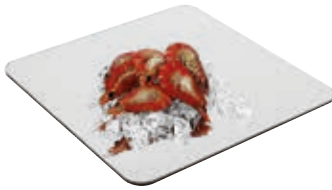

Mirror, square

Specchio quadrato
Spiegel, quadratisch
Miroir carré
Espejo cuadrado

| art. | dim. cm. | € |
|----------|----------|--------|
| 41885-40 | 40x40 | 147,33 |
| 41885-45 | 45x45 | 151,45 |
| 41885-50 | 50x50 | 168,64 |
| 41885-60 | 60x60 | 265,22 |



Mirror, oval

Specchio ovale
Spiegel, oval
Miroir ovale
Espejo oval

| art. | dim. cm. | € |
|----------|----------|--------|
| 41877-45 | 45x30 | 126,23 |
| 41877-61 | 61x45,5 | 206,23 |
| 41877-81 | 81x61 | 349,24 |
| 41877-99 | 100x70 | 591,24 |



Mirror, rectangular

Specchio rettangolare
Spiegel, rechteckig
Miroir rectangulaire
Espejo rectangular

| art. | dim. cm. | € |
|----------|----------|--------|
| 41878-45 | 45x30 | 115,78 |
| 41878-61 | 61x46 | 189,34 |
| 41878-81 | 81x58,5 | 349,24 |
| 41878-99 | 100x70 | 635,36 |



Mirror, octagon

Specchio ottagonale
Spiegel, achteckig
Miroir octogonal
Espejo octogonal

| art. | Ø cm. | € |
|----------|-------|--------|
| 41879-30 | 30 | 105,22 |
| 41879-40 | 40 | 147,33 |
| 41879-50 | 50 | 197,78 |
| 41879-61 | 61 | 256,68 |



Mirror, hexagon

Specchio esagonale
Spiegel, Sechseck
Miroir hexagon
Espejo hexágono

| art. | Ø cm. | € |
|----------|-------|--------|
| 41880-38 | 38 | 147,33 |
| 41880-61 | 61 | 286,22 |



Mirror, comma

Specchio virgola
Spiegel, Komma
Miroir virgule
Espejo vírgula

| art. | Ø cm. | € |
|----------|-------|--------|
| 41875-40 | 40,6 | 114,67 |
| 41875-61 | 61,0 | 226,83 |



Mirror, segment

Specchio spicchio
Spiegel, Segment
Miroir quartier
Espejo segmento

| art. | Ø cm. | € |
|----------|-------|--------|
| 41881-30 | 30,5 | 100,90 |
| 41881-40 | 40,5 | 143,01 |



Mirror, circle

Specchio cerchio
Spiegel, Kreis
Miroir cercle
Espejo aro

| art. | Ø cm. | € |
|----------|-------|--------|
| 41876-30 | 30,5 | 107,33 |
| 41876-38 | 38,0 | 134,77 |
| 41876-45 | 45,0 | 176,78 |
| 41876-58 | 58,0 | 244,11 |



Mirror, cube

Specchio cubo
Spiegel, Würfel
Miroir cube
Espejo cubo

| art. | dim. cm. | € |
|----------|----------|--------|
| 41882-15 | 15x15x15 | 147,33 |
| 41882-20 | 20x20x20 | 176,78 |
| 41882-25 | 25x25x25 | 286,22 |
| 41882-30 | 30x30x30 | 336,57 |

POLYPROPYLENE BASKETS
CESTI IN POLIPROPILENE SERIE ELITE



Bread basket

Cesto pane
Brotkorb
Corbeille à pain
Cesta pan

| art. | dim. cm. | GN | col. | € |
|----------|---------------|-----|------|-------|
| 42967-03 | 53x32,5x6,5 | 1/1 | ● | 23,42 |
| 42967-04 | 32,5x26,5x6,5 | 1/2 | ● | 17,59 |
| 42967-05 | 32,5x17,5x6,5 | 1/3 | ● | 14,77 |
| 42967-06 | 26,4x16,2x6,5 | 1/4 | ● | 13,47 |
| 42967-07 | 17,6x16,2x6,5 | 1/6 | ● | 10,55 |
| 42967-08 | 32,5x35,4x6,5 | 2/3 | ● | 18,39 |

Bread basket

Cesto pane
Brotkorb
Corbeille à pain
Cesta pan

| art. | dim. cm. | GN | col. | € |
|----------|--------------|-----|------|-------|
| 42967-13 | 53x32,5x10 | 1/1 | ● | 25,93 |
| 42967-14 | 32,5x26,5x10 | 1/2 | ● | 18,79 |
| 42967-15 | 32,5x17,5x10 | 1/3 | ● | 16,38 |
| 42967-16 | 26,4x16,2x10 | 1/4 | ● | 15,18 |
| 42967-17 | 17,6x16,2x10 | 1/6 | ● | 10,95 |
| 42967-18 | 32,5x35,4x10 | 2/3 | ● | 20,50 |



Bread basket

Cesto pane
Brotkorb
Corbeille à pain
Cesta pan

| art. | dim. cm. | GN | col. | € |
|----------|---------------|-----|------|-------|
| 42967-63 | 53x32,5x6,5 | 1/1 | ● | 23,42 |
| 42967-64 | 32,5x26,5x6,5 | 1/2 | ● | 17,59 |
| 42967-65 | 32,5x17,5x6,5 | 1/3 | ● | 14,77 |
| 42967-66 | 26,4x16,2x6,5 | 1/4 | ● | 13,47 |
| 42967-67 | 17,6x16,2x6,5 | 1/6 | ● | 10,55 |
| 42967-68 | 32,5x35,4x6,5 | 2/3 | ● | 18,39 |

Bread basket

Cesto pane
Brotkorb
Corbeille à pain
Cesta pan

| art. | dim. cm. | GN | col. | € |
|----------|--------------|-----|------|-------|
| 42967-73 | 53x32,5x10 | 1/1 | ● | 25,93 |
| 42967-74 | 32,5x26,5x10 | 1/2 | ● | 18,79 |
| 42967-75 | 32,5x17,5x10 | 1/3 | ● | 16,38 |
| 42967-76 | 26,4x16,2x10 | 1/4 | ● | 15,18 |
| 42967-77 | 17,6x16,2x10 | 1/6 | ● | 10,95 |
| 42967-78 | 32,5x35,4x10 | 2/3 | ● | 20,50 |





Bread basket

Cesto pane
Brot-Korb
Corbeille à pain
Cesta pan

| art. | dim. cm. | h. cm. | col. | € |
|----------|----------|--------|------|-------|
| 42973-45 | 45x40 | 16/27 | ● | 44,22 |



Bread basket

Cesto pane
Brot-Korb
Corbeille à pain
Cesta pan

| art. | dim. cm. | h. cm. | col. | € |
|----------|----------|--------|------|-------|
| 42973-60 | 60x40 | 16/27 | ● | 60,30 |

With removable divider. – Con divisorio mobile.



Bread basket

Cesto pane
Brot-Korb
Corbeille à pain
Cesta pan

| art. | dim. cm. | h. cm. | col. | € |
|----------|----------|--------|------|-------|
| 42973-30 | 30x40 | 16/27 | ● | 38,99 |



French stick bread basket

Cesta baguettes
Brotkorb für Baguette
Corbeille à baguettes
Cesta pan français

| art. | Ø cm. | h. cm. | col. | € |
|----------|-------|--------|------|-------|
| 42967-35 | 35 | 25/42 | ● | 42,51 |



French stick bread basket

Cesta baguettes
Brotkorb für Baguette
Corbeille à baguettes
Cesta pan français

| art. | Ø cm. | h. cm. | col. | € |
|----------|-------|--------|------|-------|
| 42972-28 | 30 | 38 | ● | 33,87 |



Bread basket

Cesto pane
Brotkorb
Corbeille à pain
Cesta pan

| art. | dim. cm. | col. | € |
|----------|----------|------|-------|
| 42972-01 | 40x20x5 | ● | 15,38 |
| 42972-02 | 40x30x5 | ● | 17,29 |
| 42972-03 | 60x20x5 | ● | 20,10 |
| 42972-04 | 60x40x5 | ● | 32,86 |



Bread basket

Cesto pane
Brotkorb
Corbeille à pain
Cesta pan

| art. | Ø cm. | h. cm. | - | col. | € |
|----------|-------|--------|-----|------|-------|
| 42968-42 | 42 | 12 | - | ● | 24,42 |
| 42968M42 | 42 | 12 | NEW | ● | 24,42 |



Bread basket GN 1/1

Cesto pane
Brotkorb
Corbeille à pain
Cesta pan

| art. | dim. cm. | - | col. | € |
|----------|--------------|-----|------|-------|
| 42967-53 | 53x32,5x15,5 | - | ● | 30,45 |
| 42967M53 | 53x32,5x15,5 | NEW | ● | 30,45 |



Bread basket

Cesto pane
Brotkorb
Corbeille à pain
Cesta pan

| art. | Ø cm. | h. cm. | - | col. | € |
|----------|-------|--------|-----|------|-------|
| 42969-31 | 31/37 | 6/12 | - | ● | 19,10 |
| 42969M31 | 31/37 | 6/12 | NEW | ● | 19,10 |



Bread basket

Cesto pane
Brotkorb
Corbeille à pain
Cesta pan

| art. | dim. cm. | h. cm. | - | col. | € |
|----------|----------|--------|-----|------|-------|
| 42967-43 | 45x42 | 17/24 | - | ● | 45,73 |
| 42967M43 | 45x42 | 17/24 | NEW | ● | 45,73 |



Bread basket

Cesto pane
Brotkorb
Corbeille à pain
Cesta pan

| art. | dim. cm. | col. | € |
|----------|----------|------|-------|
| 42993-40 | 40X30X10 | ● | 20,10 |
| 42993M40 | 40X30X10 | ● | 20,10 |



Bread basket

Cesto pane
Brotkorb
Corbeille à pain
Cesta pan

| art. | dim. cm. | col. | € |
|----------|-----------|------|-------|
| 42991-25 | 25x19X6,5 | ● | 10,95 |
| 42991M25 | 25x19X6,5 | ● | 10,95 |



Bread basket

Cesto pane
Brotkorb
Corbeille à pain
Cesta pan

| art. | dim. cm. | col. | € |
|----------|----------|------|-------|
| 42991-32 | 32x23X7 | ● | 13,87 |
| 42991M32 | 32x23X7 | ● | 13,87 |



Bread basket

Cesto pane
Brotkorb
Corbeille à pain
Cesta pan

| art. | Ø cm. | h. cm. | col. | € |
|----------|-------|--------|------|------|
| 42990-16 | 16 | 8 | ● | 8,94 |
| 42990M16 | 16 | 8 | ● | 8,94 |



Bread basket

Cesto pane
Brotkorb
Corbeille à pain
Cesta pan

| art. | Ø cm. | h. cm. | col. | € |
|----------|-------|--------|------|-------|
| 42990-20 | 20 | 8 | ● | 10,55 |
| 42990M20 | 20 | 8 | ● | 10,55 |



Bread basket

Cesto pane
Brotkorb
Corbeille à pain
Cesta pan

| art. | Ø cm. | h. cm. | col. | € |
|----------|-------|--------|------|-------|
| 42990-29 | 29 | 7 | ● | 12,26 |
| 42990M29 | 29 | 7 | ● | 12,26 |



Bread basket

Cesto pane
Brotkorb
Corbeille à pain
Cesta pan

| art. | Ø cm. | h. cm. | col. | € |
|----------|-------|--------|------|------|
| 42974M13 | 13 | 10 | ● | 8,04 |
| 42974B13 | 13 | 10 | ● | 8,04 |



Egg basket

Cesto uova
Eier-Korb
Panier à oeufs
Cesta para huevos

| art. | Ø cm. | h. cm. | - | col. | € |
|----------|-------|--------|-----|------|-------|
| 42949B26 | 26 | 17 | NEW | ● | 27,14 |
| 42949-26 | 26 | 17 | - | ● | 27,14 |

Fabric lining. For around 20 eggs.
Fodera in tessuto. Per circa 20 uova.



Cutlery dispenser

Portaposate
Besteck-Ablage
Panier à couverts
Cesta portacubiertos

| art. | dim. cm. | - | col. | € |
|----------|-----------|-----|------|-------|
| 42584B05 | 53x32,5x9 | NEW | ● | 56,18 |
| 42584-05 | 53x32,5x9 | - | ● | 56,18 |



Cutlery dispenser

Portaposate
Besteck-Ablage
Panier à couverts
Cesta portacubiertos

| art. | dim. cm. | - | col. | € |
|----------|------------|-----|------|-------|
| 42584-04 | 53x32,5x10 | - | ● | 49,45 |
| 42584M04 | 53x32,5x10 | NEW | ● | 49,45 |



Cutlery dispenser

Portaposate
Besteck-Ablage
Panier à couverts
Cesta portacubiertos

| art. | dim. cm. | col. | € |
|----------|----------|------|-------|
| 42584-07 | 26x18x15 | ● | 22,11 |
| 42584-06 | 26x18x15 | ● | 22,11 |





Cutlery dispenser
Portaposate
Besteck-Ablage
Panier à couverts
Cesta portacubiertos

| art. | dim. cm. | - | col. | € |
|----------|-----------|-----|------|------|
| 42584-02 | 27x10x4,5 | - | ● | 9,35 |
| 42584M02 | 27x10x4,5 | NEW | ● | 9,35 |



Cutlery dispenser
Portaposate
Besteck-Ablage
Panier à couverts
Cesta portacubiertos

| art. | Ø cm. | h. cm. | - | col. | € |
|----------|-------|--------|-----|------|------|
| 42584-01 | 12 | 15 | - | ● | 8,64 |
| 42584M01 | 12 | 15 | NEW | ● | 8,64 |



Bread basket
Cesto pane
Brotkorb
Corbeille à pain
Cesta pan

| art. | dim. cm. | GN | col. | € |
|----------|------------|-----|------|-------|
| 42461-11 | 56,5x36x10 | 1/1 | ● | 54,37 |
| 42967-11 | 56,5x36x10 | 1/1 | ● | 54,37 |

With frame to fix the cover.
Con telaio per fissare il coperchio.



Roll-top cover
Coperchio roll-top
Rolltophaube
Couvercle roll-top
Tapa roll-top

| art. | dim. cm. | GN | € |
|----------|------------|-----|--------|
| 41415-11 | 53x32,5x17 | 1/1 | 119,70 |

Chrome handle. – Maniglia cromata.



Roll-top cover
Coperchio roll-top
Rolltophaube
Couvercle roll-top
Tapa roll-top

| art. | dim. cm. | GN | € |
|----------|------------|-----|--------|
| 42452-53 | 53x32,5x17 | 1/1 | 115,88 |

Chrome handle. – Maniglia cromata.



Cover
Coperchio
Kuppelhaube
Couvercle
Campana

| art. | dim. cm. | GN | € |
|----------|----------|-----|-------|
| 41419-12 | 33x28x17 | 1/2 | 50,05 |

One front cut. – Con apertura frontale.



Cover
Coperchio
Kuppelhaube
Couvercle
Campana

| art. | dim. cm. | GN | € |
|----------|----------|-----|-------|
| 41418-11 | 54x33x20 | 1/1 | 84,52 |

One front cut. – Con apertura frontale.



Cover
Coperchio
Kuppelhaube
Couvercle
Campana

| art. | dim. cm. | GN | € |
|----------|----------|-----|-------|
| 41418-12 | 54x33x20 | 1/1 | 90,45 |

Totally closed. – Chiuso.



Bread basket
Cesto pane
Brotkorb
Corbeille à pain
Cesta pan

| art. | Ø cm. | h. cm. | - | col. | € |
|----------|-------|--------|-----|------|-------|
| 42461B35 | 35 | 12 | NEW | ● | 41,51 |
| 42461-35 | 35 | 12 | - | ● | 41,51 |

With frame to fix the cover.
Con telaio per fissare il coperchio.



Roll-top cover
Coperchio roll-top
Rolltophaube
Couvercle roll-top
Campana roll-top

| art. | Ø cm. | h. cm. | € |
|----------|-------|--------|-------|
| 42452-35 | 38 | 20 | 40,60 |

Chrome handle. – Maniglia cromata.



Roll-top cover
Coperchio roll-top
Rolltophaube
Couvercle roll-top
Campana roll-top

| art. | Ø cm. | h. cm. | € |
|----------|-------|--------|-------|
| 41447-38 | 38 | 20 | 40,50 |

Chrome knob. – Pomolo cromato.



Roll-top cover
Coperchio roll-top
Rolltophaube
Couvercle roll-top
Campana roll-top

| art. | Ø cm. | h. cm. | € |
|----------|-------|--------|-------|
| 41945-38 | 38 | 20 | 40,50 |

Chrome knob. – Pomolo cromato.

POLYPROPYLENE BASKETS
CESTI IN POLIPROPILENE SERIE LINE



Bread basket

Cesto pane
Brotkorb
Corbeille à pain
Cesta pan

| art. | Ø cm. | h. cm. | € |
|----------|-------|--------|------|
| 42948-18 | 10 | 7 | 2,41 |
| 42948-20 | 20 | 7 | 2,61 |
| 42948-25 | 25 | 7 | 3,02 |



Bread basket

Cesto pane
Brotkorb
Corbeille à pain
Cesta pan

| art. | dim. cm. | € |
|----------|-----------|------|
| 42948-23 | 23x15x6,5 | 3,12 |



Bread basket

Cesto pane
Brotkorb
Corbeille à pain
Cesta pan

| art. | Ø cm. | h. cm. | € |
|----------|-------|--------|------|
| 42935-19 | 19 | 9 | 6,73 |
| 42935-26 | 26 | 9 | 8,04 |



Bread basket

Cesto pane
Brotkorb
Corbeille à pain
Cesta pan

| art. | Ø cm. | h. cm. | € |
|----------|-------|--------|------|
| 42944-23 | 23 | 7 | 5,23 |



Bread basket

Cesto pane
Brotkorb
Corbeille à pain
Cesta pan

| art. | dim. cm. | € |
|----------|----------|------|
| 42945-27 | 27x20x10 | 5,63 |



Bread basket

Cesto pane
Brotkorb
Corbeille à pain
Cesta pan

| art. | dim. cm. | € |
|----------|-----------|------|
| 42945-18 | 18x13x6,5 | 2,21 |
| 42945-23 | 23x15x6,5 | 2,71 |





Bread basket

Cesto pane
Brotkorb
Corbeille à pain
Cesta pan

| art. | dim. cm. | € |
|----------|----------|------|
| 42936-23 | 23x19x9 | 7,54 |



Bread basket

Cesto pane
Brotkorb
Corbeille à pain
Cesta pan

| art. | dim. cm. | € |
|----------|-----------|------|
| 42936-24 | 24x17x8 | 6,63 |
| 42936-28 | 28x16x8,5 | 7,14 |



Bread basket

Cesto pane
Brotkorb
Corbeille à pain
Cesta pan

| art. | dim. cm. | € |
|----------|-----------|------|
| 42946-23 | 23x10x6 | 2,51 |
| 42946-37 | 37,5x15x7 | 4,42 |



Bread basket

Cesto pane
Brotkorb
Corbeille à pain
Cesta pan

| art. | dim. cm. | € |
|----------|----------|------|
| 42947-23 | 23x15x7 | 2,81 |
| 42947-30 | 30x22x7 | 4,52 |
| 42947-40 | 41x29x7 | 7,44 |



Bread basket

Cesto pane
Brotkorb
Corbeille à pain
Cesta pan

| art. | Ø cm. | h. cm. | € |
|----------|-------|--------|-------|
| 42968-38 | 38 | 10 | 20,20 |



Bread basket stand

Alzata ceste
Körbe-Gestell
Etagère à corbeilles
Soporte ceste pan

| art. | dim. cm. | € |
|----------|------------|-------|
| 42870-59 | 30,5x59x58 | 37,19 |

For baskets 42968-38 and 42967-13.
Per cesti 42968-38 e 42967-13.



Basket with black wire stand

Cesto con supporto filo nero
Korbdrahtgestell, schwarz
Panier support en fil noir
Cesta estructura alambre negro

| art. | dim. cm. | € |
|----------|----------|-------|
| 41220-02 | 40x30 | 25,43 |
| 41220-03 | 60x40 | 39,60 |



Basket with black wire stand

Cesto con supporto filo nero
Korbdrahtgestell, schwarz
Panier support en fil noir
Cesta estructura alambre negro

| art. | Ø cm. | h. cm. | € |
|----------|-------|--------|-------|
| 41220-01 | 38 | 15,5 | 29,85 |



Basket with black wire stand

Cesto con supporto filo nero
Korbdrahtgestell, schwarz
Panier support en fil noir
Cesta estructura alambre negro

| art. | Ø cm. | h. cm. | € |
|----------|-------|--------|-------|
| 41220-04 | 33 | 15,5 | 23,52 |



Basket with black wire stand

Cesto con supporto filo nero
Korbdrahtgestell, schwarz
Panier support en fil noir
Cesta estructura alambre negro

| art. | Ø cm. | h. cm. | € |
|----------|-------|--------|-------|
| 41220-05 | 43 | 15,5 | 30,45 |



Wire stand black, 2 tiers

Supporto filo nero, 2 piani
Brotkorb-Drahtgestell, Doppeldecker
Support en fil noir, 2 étages
Estructura alambre negro, 2 alturas

| art. | dim. cm. | GN | € |
|----------|------------|-----|-------|
| 41220-06 | 44,5x26x22 | 1/2 | 18,79 |

Baskets not included. – Cesti non incusi.



Wire stand black

Supporto filo nero
Drahtgestell, schwarz
Support en fil noir
Estructura alambre negro

| art. | dim. cm. | GN | € |
|----------|--------------|-----|-------|
| 41220-07 | 49,5x30x13,5 | 1/1 | 20,50 |

Basket not included. – Cesto non incluso.



Black wire basket

Cesto in filo nero
Drahtkorb, schwarz
Panier en fil noir
Cesta alambre negro

| art. | dim. cm. | GN | € |
|----------|-------------|-----|-------|
| 41220-11 | 53x32,5x7,5 | 1/1 | 54,77 |

**Fits cover / Coperchio idoneo:
41418B11, 41418-11, 41418-12.**



Black wire basket

Cesto in filo nero
Drahtkorb, schwarz
Panier en fil noir
Cesta alambre negro

| art. | dim. cm. | GN | € |
|----------|---------------|-----|-------|
| 41220-12 | 32,5x26,5x7,5 | 1/2 | 40,70 |

**Fits cover / Coperchio idoneo:
41419B12, 41419-12.**



Black wire basket

Cesto in filo nero
Drahtkorb, schwarz
Panier en fil noir
Cesta alambre negro

| art. | dim. cm. | GN | € |
|----------|-------------|-----|-------|
| 41220-24 | 53x16,2x7,5 | 2/4 | 40,70 |

Fits cover / Coperchio idoneo: 41420-24.



Cover front cut

Coperchio apertura frontale
Kuppelhaube, Front-Ausschnitt
Couvricle ouverture frontale
Campana apertura frontal

| art. | dim. cm. | GN | € |
|----------|----------|-----|-------|
| 41418B11 | 54x33x20 | 1/1 | 84,52 |

Die cast zinc knob. – Maniglia in zinco pressofuso.



Cover front cut

Coperchio apertura frontale
Kuppelhaube, Front-Ausschnitt
Couvricle ouverture frontale
Campana apertura frontal

| art. | dim. cm. | GN | € |
|----------|----------|-----|-------|
| 41419B12 | 33x28x17 | 1/2 | 50,05 |

Die cast zinc knob. – Maniglia in zinco pressofuso.



Canvas egg bag

Cesto uova cotone
Eiertasche, Baumwolle
Panier à oeufs, coton
Cesta huevos, algodón

| art. | Ø cm. | h. cm. | col. | € |
|----------|-------|--------|------|-------|
| 42873-01 | 20 | 23,5 | ● | 35,48 |
| 42873-02 | 20 | 23,5 | ● | 35,48 |

With stone pillow. To heat up in microwave for 90 sec. at 500 Watt. Machine washable up to 30°C (except pillow). – Con cuscino noccioli di ceramica. Scaldare in microonde per 90 secondi a 500 Watt. Lavabile in lavatrice max 30°C (escluso cuscino).





Canvas bag, round

Cesto cotone, rotondo
Brottasche, rund, Baumwolle
Panier à pain rond, coton
Cesta pan redonda, algodón

| art. | Ø cm. | h. cm. | col. | € |
|----------|-------|--------|------|-------|
| 42875-17 | 17 | 11 | ● | 11,86 |
| 42875-20 | 20 | 12 | ● | 13,07 |

Cotton, machine-washable up to 30° C.
Cotone, lavabile a macchina fino a 30° C.



Canvas bag, round

Cesto cotone, rotondo
Brottasche, rund, Baumwolle
Panier à pain rond, coton
Cesta pan redonda, algodón

| art. | Ø cm. | h. cm. | col. | € |
|----------|-------|--------|------|-------|
| 42875B17 | 17 | 11 | ● | 12,36 |
| 42875B20 | 20 | 12 | ● | 13,67 |

Cotton, machine-washable up to 30° C.
Cotone, lavabile a macchina fino a 30° C.



NEW

Canvas bag, round

Cesto cotone, rotondo
Brottasche, rund, Baumwolle
Panier à pain rond, coton
Cesta pan redonda, algodón

| art. | Ø cm. | h. cm. | col. | € |
|----------|-------|--------|------|------|
| 42876-12 | 12 | 15 | ● | 6,23 |

Cotton, machine-washable up to 30° C.
Cotone, lavabile a macchina fino a 30° C.



Canvas bag, oval

Cesto cotone, ovale
Brottasche, oval, Baumwolle
Panier à pain ovale, coton
Cesta pan , algodón

| art. | dim. cm. | col. | € |
|----------|----------|------|-------|
| 42876-20 | 20x15x10 | ● | 12,26 |
| 42876-25 | 25x18x12 | ● | 14,67 |

Cotton, machine-washable up to 30° C.
Cotone, lavabile a macchina fino a 30° C.



NEW



Buffet box 2 compartments

Espositore buffet 2 sezioni
Buffet Box, 2 Fächer
Boîte à buffet 2 sections
Caja para buffet 2 secciones

| art. | dim. cm. | € |
|----------|------------|--------|
| 42464-02 | 36x33,5x16 | 150,35 |

Natural oak. – Rovere naturale.



NEW



Buffet box

Espositore buffet
Buffet Box
Boîte à buffet
Caja para buffet

| art. | dim. cm. | ext. | € |
|----------|----------|--------------|--------|
| 42464-03 | 36x29x28 | 70,5x37x53,5 | 452,45 |

Natural oak. – Rovere naturale.



W

Bread box

Cassetta pane
Brotkiste
Caisse à pain
Cajón para pan

| art. | dim. cm. | € |
|----------|------------|--------|
| 42874-01 | 34x26x12,5 | 88,44 |
| 42874-02 | 34x26x20 | 127,64 |

Beech wood. – Faggio.



Bread cutting board

Tagliere
Brotschneidbrett
Planche à découper
Tabla de corte

| art. | dim. cm. | € |
|----------|----------|---|
| 42874-03 | 52x34x2 | - |

Beech wood. – Faggio.



Cutting board tray

Vassoio per tagliere
Schneidbrett-Tablett
Plateau pour planche à découper
Bandeja para tabla de corte

| art. | dim. cm. | € |
|----------|-------------|---|
| 42874-04 | 60x35,5x3,5 | - |



Bread slicer

Taglia pane
Brotschneidergerät
Coupe-pain
Corta-pan

| art. | dim. cm. | € |
|----------|----------|--------|
| 49833-00 | 40x11x15 | 135,57 |

Stainless steel blade 35 cm. – Lama inox 35 cm.



Pretzel stand

Porta Brezel
Brezel-ständer
Support à brezel
Soporte para brezel

| art. | Ø cm. | h. cm. | € |
|----------|-------|--------|-------|
| 42870-50 | 22 | 50 | 35,48 |

Beechwood. – Faggio.



Sign holders, chromed

Clip flessibili, cromate
Schildhalter, verchromt
Porte-étiquettes, chromés
Porta etiquetas con clip, cromade

| art. | l. cm. | pcs/pz | € |
|----------|--------|--------|------|
| 41394-02 | 12 | 1 | 5,83 |



All purpose tongs

Molla universale
Universalzange
Pince universelle
Pinza universal

| art. | l. cm. | col. | € |
|----------|--------|------|------|
| 41506-19 | 19,5 | ● | 6,53 |
| 41506C19 | 19,5 | ● | 7,24 |
| 41506B19 | 19,5 | ● | 7,24 |

Mirror polished, with fastening clip.
Finitura lucida, con clip di fissaggio.





Chalkmarker

Penna a gesso liquido

Kreidestifte

Stylo à craie liquide

Rotulador de tiza líquida

| art. | Ø mm. | col. | € |
|----------|-------|------|------|
| 47832-00 | 5 | ○ | 4,92 |
| 47832-01 | 5 | ● | 4,92 |
| 47832-02 | 5 | ● | - |
| 47832-03 | 5 | ● | - |
| 47832-04 | 5 | ● | - |
| 47832-05 | 5 | ● | 4,92 |

Clean with water. Writes on all non porous surfaces. – Pulire con acqua. Scrive su tutte le superfici non porose.



Chalkmarker

Penna a gesso liquido

Kreidestifte

Stylo à craie liquide

Rotulador de tiza líquida

| art. | Ø mm. | col. | € |
|----------|-------|------|------|
| 47832-10 | 15 | ○ | 9,95 |
| 47832-11 | 15 | ● | 9,95 |
| 47832-12 | 15 | ● | 9,95 |
| 47832-13 | 15 | ● | 9,95 |
| 47832-14 | 15 | ● | 9,95 |
| 47832-15 | 15 | ● | 9,95 |



Sandwich board

Lavagna cavalletto bifacciale

Gehwegtafel

Tableau chevalet 2 faces

Pizarra en ángulo

| art. | dim. cm. | h. cm. | € |
|----------|----------|--------|--------|
| 44185-50 | 50x72 | 85 | 78,49 |
| 44185-70 | 69x100 | 120 | 125,02 |

MDF surface with wooden frame. Lavagna in MDF con cornice in legno.



Wall board

Lavagna da muro

Wandtafel

Tableau mural

Pizarra murale

| art. | dim. cm. | € |
|----------|----------|-------|
| 44187-40 | 40x60 | 12,16 |
| 44187-60 | 60x80 | 19,90 |

MDF surface. – Lavagna in MDF.

BUFFET SYSTEM



ACACIA WOOD for a multifunctional buffet system that adapts in height and width to all space requirements. The stackable and non-slip reversible boxes can be used individually or connected with flat GN trays.

LEGNO DI ACACIA per un sistema multifunzionale che si adatta in altezza e larghezza a tutte le esigenze di spazio. Le scatole reversibili, impilabili e antiscivolo possono essere utilizzate singolarmente o collegate con i piani GN.



Box
Scatola
Wendebox
Boîte
Caja

| art. | dim. cm. | GN | € |
|----------|--------------|-----|-------|
| 42463A02 | 55,5x35x10,5 | 1/1 | 77,59 |



NEW

Box
Scatola
Wendebox
Boîte
Caja

| art. | dim. cm. | GN | € |
|----------|------------|-----|--------|
| 42463A12 | 55,5x35x20 | 1/1 | 108,24 |



Box
Scatola
Wendebox
Boîte
Caja

| art. | dim. cm. | GN | € |
|----------|----------------|-----|-------|
| 42463A04 | 55,5x18,5x10,5 | 2/4 | 60,80 |



Box
Scatola
Wendebox
Boîte
Caja

| art. | dim. cm. | GN | € |
|----------|------------|-----|-------|
| 42463A05 | 35x29x10,5 | 1/2 | 48,94 |



NEW

Box
Scatola
Wendebox
Boîte
Caja

| art. | dim. cm. | GN | € |
|----------|----------|-----|-------|
| 42463A15 | 35x29x20 | 1/2 | 68,64 |



Box
Scatola
Wendebox
Boîte
Caja

| art. | dim. cm. | GN | € |
|----------|--------------|-----|-------|
| 42463A08 | 29x18,5x10,5 | 1/4 | 38,79 |





Box
Scatola
Wendebox
Boîte
Caja

| art. | dim. cm. | GN | € |
|----------|--------------|-----|-------|
| 42463B02 | 55,5x35x10,5 | 1/1 | 77,59 |



NEW

Box
Scatola
Wendebox
Boîte
Caja

| art. | dim. cm. | GN | € |
|----------|------------|-----|--------|
| 42463B12 | 55,5x35x20 | 1/1 | 108,24 |



Box
Scatola
Wendebox
Boîte
Caja

| art. | dim. cm. | GN | € |
|----------|----------------|-----|-------|
| 42463B04 | 55,5x18,5x10,5 | 2/4 | 60,80 |



Box
Scatola
Wendebox
Boîte
Caja

| art. | dim. cm. | GN | € |
|----------|------------|-----|-------|
| 42463B05 | 35x29x10,5 | 1/2 | 48,94 |



NEW

Box
Scatola
Wendebox
Boîte
Caja

| art. | dim. cm. | GN | € |
|----------|----------|-----|-------|
| 42463B15 | 35x29x20 | 1/2 | 68,64 |



Box
Scatola
Wendebox
Boîte
Caja

| art. | dim. cm. | GN | € |
|----------|--------------|-----|-------|
| 42463B08 | 29x18,5x10,5 | 1/4 | 38,79 |



NEW

Buffet stand
Supporto buffet
Buffetgestell
Présentoir buffet
Soporte para buffet

| art. | dim. cm. | GN | € |
|----------|------------|---------|-------|
| 42463-02 | 49x38,5x48 | 1/1-1/2 | 78,29 |



NEW

Buffet stand 3 pieces
Espositore buffet 3 pezzi
Buffetgestell 3-teilig
Présentoir buffet 3 pièces
Expositor buffet 3 piezas

| art. | dim. cm. | € |
|----------|----------|---|
| 42460-40 | 40x40x33 | - |

Rubberwood, wenge.
1. 40x40x33 ; 2. 40x37x20 ; 3. 40x34x9 cm.



NEW

Buffet stand 2-tier

Espositore buffet 2 piani
Buffetgestell 3-stufig
Présentoir buffet 2 étages
Expositor buffet 2 alturas

| art. | dim. cm. | € |
|----------|------------|--------|
| 41209-06 | 80x23x40,5 | 234,87 |

Oak wood, metal PVC coated.
Rovere, metallo con rivestimento PVC.



NEW

Buffet board

Mensola buffet
Buffet-Brett
Planche à buffet
Tabla de buffet

| art. | dim. cm. | € |
|----------|----------|-------|
| 41209-05 | 80x20x2 | 80,50 |

Oak wood. – Rovere.



NEW

Buffet stand

Supporto buffet
Buffetständer
Présentoir buffet
Soporte para buffet

| art. | dim. cm. | € |
|----------|------------|-------|
| 41209-02 | 19x23x40,5 | 36,98 |



NEW

Buffet stand

Supporto buffet
Buffetständer
Présentoir buffet
Soporte para buffet

| art. | dim. cm. | € |
|----------|----------|-------|
| 41209-01 | 12x12x7 | 10,55 |

Metal PVC coated.
Metallo con rivestimento PVC.



NEW

Buffet board

Tavola buffet
Buffet-Brett
Planche à buffet
Tabla de buffet

| art. | dim. cm. | GN | € |
|----------|-------------|-----|-------|
| 41209-03 | 53x32,5x2,5 | 1/1 | 72,06 |

Oiled oak wood board.
Tavola in legno di rovere oliato.



NEW

Buffet board

Tavola buffet
Buffet-Brett
Planche à buffet
Tabla de buffet

| art. | dim. cm. | GN | € |
|----------|-------------|-----|-------|
| 41209-04 | 53x16,5x2,5 | 2/4 | 46,93 |

Oiled oak wood board.
Tavola in legno di rovere oliato.



NEW

W
SAN
SS

Showplate, 3-pcs set

Vetrina, set 3 pezzi
Buffetvitrine, 3-teilig
Etagère, set 3 pièces
Vitrina, 3 elementos

| art. | Ø cm. | h. cm. | € |
|----------|-------|--------|--------|
| 41905-38 | 43 | 4,5 | 333,56 |

Roll-top 41447-38 not included.
Coperchio 41447-38 non incluso.



SAN

Roll-top cover
Coperchio roll-top
Rolltophaube
Couvercle roll-top
Campana roll-top

| art. | Ø cm. | h. cm. | € |
|----------|-------|--------|-------|
| 41447-38 | 38 | 20 | 40,50 |

Chrome knob. – Pomolo cromato.



SAN

SS

Showplate, 2-pcs set
Vetrina, set 2 pezzi
Buffetvitrine, 2-teilig
Etagère, set 2 pièces
Vitrina, 2 elementos

| art. | Ø cm. | h. cm. | € |
|----------|-------|--------|-------|
| 41447-02 | 38 | 21 | 73,87 |



SAN

SS

Showplate, 5-pcs set
Vetrina, set 5 pezzi
Buffetvitrine, 5-teilig
Etagère, set 5 pièces
Vitrina, 5 elementos

| art. | Ø cm. | h. cm. | € |
|----------|-------|--------|-------|
| 41447-05 | 38 | 24 | 97,89 |



SAN

Roll-top cover
Coperchio roll-top
Rolltophaube
Couvercle roll-top
Campana roll-top

| art. | Ø cm. | h. cm. | € |
|----------|-------|--------|-------|
| 41945-38 | 38 | 20 | 40,50 |



PC

Roll-top cover
Coperchio roll-top
Rolltophaube
Couvercle roll-top
Campana roll-top

| art. | dim. cm. | GN | € |
|----------|------------|-----|--------|
| 41415-11 | 53x32,5x17 | 1/1 | 119,70 |

Chrome knob. – Pomolo cromato.



W

PP

PS

Ice-box, 3 pcs set
Box portagiaccio, set 3 pz
Eisbox, 3-teilig
Boîte à glaçons, 3 pièces
Cubitera, 3 elementos

| art. | dim. cm. | € |
|----------|--------------|---|
| 41412-11 | 53x32,5x12,5 | - |

Box wenge + plastic deep tray + drainer plate.
Base wengé + vasca plastica + griglia.

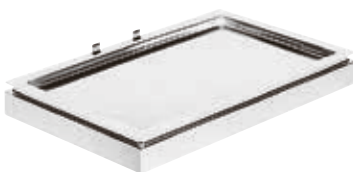

SS

Cool plate
Vetrina refrigerata
Buffet-Vitrine, kühlbar
Vitrine réfrigérée
Vitrina refrigerada

| art. | dim. cm. | GN | € |
|----------|-------------|-----|--------|
| 42450-00 | 53x32,5x8,5 | 1/1 | 415,17 |

GN 1/1 base element, s/s platter, cooler.
Base GN 1/1, vassoio inox, eutettico.

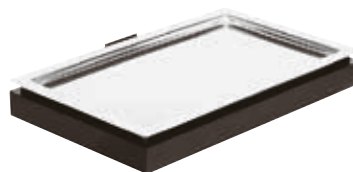

W

SS

Cool plate
Vetrina refrigerata
Buffet-Vitrine, kühlbar
Vitrine réfrigérée
Vitrina refrigerada

| art. | dim. cm. | GN | € |
|----------|-------------|-----|--------|
| 42460-00 | 53x32,5x8,5 | 1/1 | 420,19 |

GN 1/1 base element, s/s platter, cooler.
Base GN 1/1, vassoio inox, eutettico.



W

SS

Cool plate
Vetrina refrigerata
Buffet-Vitrine, kühlbar
Vitrine réfrigérée
Vitrina refrigerada

| art. | dim. cm. | GN | € |
|----------|-------------|-----|---|
| 42470-00 | 53x32,5x8,5 | 1/1 | - |

GN 1/1 base element, s/s platter, cooler.
Base GN 1/1, vassoio inox, eutettico.



Eutectic pad

Accumulatore di freddo
Kühlakku
Cartouche eutectique
Placa eutética

| art. | dim. cm. | € |
|----------|-----------|-------|
| 42450-AD | 41x21x2,5 | 25,83 |



GN roll-top cover

Coperchio GN roll-top
GN-Rolltophaube
Couvercle roll-top, GN
Tapa roll-top, GN

| art. | GN | € |
|----------|-----|--------|
| 42452-53 | 1/1 | 115,88 |



Tray

Vassoio
Tablett
Plateau
Bandeja

| art. | GN | € |
|----------|-----|-------|
| 42451-11 | 1/1 | 55,68 |
| 42451-12 | 1/2 | 31,05 |



Cutting board

Tagliere
Tranchierbrett
Planche à découper
Plancha para cortar

| art. | GN | € |
|----------|-----|---|
| 42470-06 | 1/1 | - |



Cutting board

Tagliere
Tranchierbrett
Planche à découper
Plancha para cortar

| art. | GN | € |
|----------|-----|--------|
| 42460-06 | 1/1 | 106,33 |



Cooled buffet showcase

Vetrina refrigerata
Büffet-Vitrine, kühlbar
Vitrine réfrigérée
Vitrina refrigerada

| art. | dim. cm. | col. | € |
|----------|--------------|------|--------|
| 42470-63 | 63,5x42,5x31 | ● | 597,27 |

Woodbase with fixed roll-top cover, plastic case, GN 1/1 melamine tray, cooling unit. – Base legno con coperchio roll-top fisso, vasca plastica, GN 1/1 in melamina, placca eutettica.



Cooled buffet showcase

Vetrina refrigerata
Büffet-Vitrine, kühlbar
Vitrine réfrigérée
Vitrina refrigerada

| art. | dim. cm. | col. | € |
|----------|--------------|------|--------|
| 42460-63 | 63,5x42,5x31 | ● | 597,27 |

Woodbase with fixed roll-top cover, plastic case, GN 1/1 melamine tray, cooling unit. – Base legno con coperchio roll-top fisso, vasca plastica, GN 1/1 in melamina, placca eutettica.



Cutlery dispenser

Portaposate
Besteck-Behälter
Bac à couverts
Caja portacubiertos

| art. | dim. cm. | col. | € |
|----------|------------|------|--------|
| 42470-64 | 57,5x37x12 | ● | 142,11 |



Cutlery dispenser

Portaposate
Besteck-Behälter
Bac à couverts
Caja portacubiertos

| art. | dim. cm. | col. | € |
|----------|------------|------|--------|
| 42460-64 | 57,5x37x12 | ● | 142,11 |





MF

Bowl

Ciotola

Schüssel

Bol

Cuenco

| art. | Ø cm. | h. cm. | lt. | col. | € |
|----------|-------|--------|-----|------|-------|
| 44837B05 | 14 | 6,5 | 0,5 | ● | 8,34 |
| 44837B20 | 20 | 9,2 | 1,8 | ● | 17,59 |
| 44837B25 | 23 | 10,0 | 2,5 | ● | 19,90 |



MF

Bowl

Ciotola

Schüssel

Bol

Cuenco

| art. | Ø cm. | h. cm. | lt. | col. | € |
|----------|-------|--------|-----|------|-------|
| 44837-05 | 14 | 6,5 | 0,5 | ○ | 8,34 |
| 44837-20 | 20 | 9,2 | 1,8 | ○ | 17,59 |
| 44837-25 | 23 | 10,0 | 2,5 | ○ | 19,90 |



Set 12 small bowls

Conf. 12 ciotoline

Satz 12 Mini-Gläser

Set 12 mini bols

Juego 12 cuencos

| art. | Ø cm. | h. cm. | ml. | € |
|----------|-------|--------|-----|-------|
| 41204-10 | 7 | 5,5 | 90 | 19,40 |



Bowl, glass

Ciotola, vetro

Glasschüssel

Bol en verre

Cuenco vidrio

| art. | Ø cm. | h. cm. | lt. | € |
|----------|-------|--------|------|-------|
| 41425-AA | 7,5 | 3,5 | 0,09 | - |
| 41405-AA | 14,0 | 6,5 | 0,5 | 4,72 |
| 41400-AA | 23,0 | 10,0 | 2,5 | 10,95 |



PC

Airtight cover

Coperchio ermetico

Frischhaltedeckel

Couvercle hermétique

Tapa hermética

| art. | Ø cm. | € |
|----------|-------|---|
| 42452-14 | 14 | - |
| 42452-23 | 23 | - |



AY

Cover

Coperchio

Deckel

Couvercle

Tapa

| art. | Ø cm. | € |
|----------|-------|-------|
| 42453-23 | 23 | 20,70 |



W

Cool bowl

Ciotola refrigerata

Kühlschale

Bol réfrigérée

Cuenco refrigerdo

| art. | dim. cm. | lt. | col. | € |
|----------|--------------|-----|------|--------|
| 42470-27 | 27,5x27,5x14 | 2,5 | ● | 192,36 |

Wood base, s/s container, melamine bowl, cooling unit. – Base legno, contenitore inox, ciotola melamina, placca eutettica.



W

Cool bowl

Ciotola refrigerata

Kühlschale

Bol réfrigérée

Cuenco refrigerdo

| art. | dim. cm. | lt. | col. | € |
|----------|--------------|-----|------|--------|
| 42460-27 | 27,5x27,5x14 | 2,5 | ● | 192,36 |

Wood base, s/s container, melamine bowl, cooling unit. – Base legno, contenitore inox, ciotola melamina, placca eutettica.



**BUFFET
DISPLAY & PRESENTATION**



AY
PC
SS

Cool bowl

Ciotola refrigerata
Kühlschale
Bol réfrigérée
Cuenco refrigerado

| art. | Ø cm. | h. cm. | lt. | € |
|----------|-------|--------|-----|-------|
| 41448-06 | 14 | 9,0 | 0,6 | 81,00 |
| 41448-10 | 14 | 11,5 | 1,0 | 84,32 |

Base + cooler + bowl + cover.

Base + eutettico + ciotola + coperchio.



AY
PC
SS

Cool bowl

Ciotola refrigerata
Kühlschale
Bol réfrigérée
Cuenco refrigerado

| art. | Ø cm. | h. cm. | lt. | € |
|----------|-------|--------|-----|--------|
| 41448-25 | 22 | 14 | 2,5 | 182,31 |
| 41448-40 | 22 | 18 | 4,0 | 189,04 |

Base + cooler + bowl + cover.

Base + eutettico + ciotola + coperchio.



Buffet stand, chrome plated

Alzata, cromata
Buffet-Gestell, Metall hartverchromt
Présentoir, chromé
Soporte, cromado

| art. | dim. cm. | € |
|----------|----------|--------|
| 41442-03 | 61x24x35 | 229,54 |

3 glass bowls ø cm 23 + 3 covers.

3 ciotole ø cm 23 + covers.



MF

Bowl

Ciotola
Schüssel
Bol
Cuenco

| art. | dim. cm. | col. | € |
|----------|-------------|------|-------|
| 44884-12 | 12,5x12,5x6 | ○ | 12,16 |
| 44884-19 | 19x19x9,5 | ○ | 28,64 |
| 44884-25 | 25x25x12 | ○ | 52,26 |
| 44884B12 | 12,5x12,5x6 | ● | 12,16 |
| 44884B19 | 19x19x9,5 | ● | 28,64 |
| 44884B25 | 25x25x12 | ● | 52,26 |



SAN

Cover

Coperchio
Deckel
Couvercle
Tapa

| art. | dim. cm. | € |
|----------|----------|-------|
| 44885-19 | 19x19 | 15,18 |
| 44885-25 | 25x25 | 19,20 |

With spoon notch. – Con spacco cucchiaio.



Serving stand, chrome plated

Alzata, cromata
Serviergestell, Metall hartverchromt
Présentoir, chromé
Soporte platos, cromado

| art. | dim. cm. | col. | € |
|----------|--------------|------|-------|
| 42962C26 | 18,5x15,5x26 | ● | 45,23 |
| 42962C44 | 29x19,5x43 | ● | 72,66 |

26: for 3 plates max. Ø 17 cm, inside Ø 10,5 cm.

44: for 3 plates max. Ø 27 cm, inside Ø 18 cm.



Serving stand

Alzata
Serviergestell
Présentoir
Soporte platos

| art. | dim. cm. | € |
|----------|--------------|-------|
| 42962-26 | 18,5x15,5x26 | 41,31 |
| 42962-30 | 29x19,5x30 | 54,57 |
| 42962-44 | 29x19,5x43 | 49,65 |

26: for 3 plates max. Ø 17 cm, inside Ø 10,5 cm.

30: for 2 plates max. Ø 27 cm, inside Ø 18 cm.

44: for 3 plates max. Ø 27 cm, inside Ø 18 cm.



NEW

Serving stand

Alzata
Serviergestell
Présentoir
Soporte platos

| art. | dim. cm. | € |
|----------|------------|-------|
| 42962B30 | 29x19,5x30 | 51,66 |
| 42962B44 | 29x19,5x43 | 65,73 |

30: for 2 plates max. Ø 27 cm, inside Ø 18 cm.

44: for 3 plates max. Ø 27 cm, inside Ø 18 cm.



Buffet ladder, chrome plated

Espositore buffet, cromato
Buffet-Leiter, verchromt
Escalier à buffet, chromé
Escalera para buffet, cromada

| art. | dim. cm. | € |
|----------|----------|--------|
| 41912-03 | 30x30x48 | 219,29 |

With 4 bowls ø cm 14 + lids.

Con 4 ciotole ø cm 14 + coperchi.





Buffet ladder, chrome plated

Espositore buffet, cromato
Büffet-Leiter, verchromt
Escalier à buffet, chromé
Escalera para buffet, cromada

| art. | dim. cm. | € |
|----------|----------|--------|
| 41912-04 | 30x30x48 | 185,62 |

With 6 bowls ø cm 14. – Con 6 ciotole ø cm 14.



Buffet ladder, chrome plated

Espositore buffet, cromato
Büffet-Leiter, verchromt
Escalier à buffet, chromé
Escalera para buffet, cromada

| art. | dim. cm. | € |
|----------|----------|--------|
| 41913-03 | 39x31x66 | 354,36 |

With 4 bowls ø cm 23 + lids.
Con 4 ciotole ø cm 23 + coperchi.



Buffet ladder, chrome plated

Espositore buffet, cromato
Büffet-Leiter, verchromt
Escalier à buffet, chromé
Escalera para buffet, cromada

| art. | dim. cm. | € |
|----------|----------|---|
| 41913-04 | 39x31x66 | - |

With 6 bowls ø cm 23. – Con 6 ciotole ø cm 23.



GN

Buffet ladder, chrome plated

Espositore buffet, cromato
Büffet-Leiter, verchromt
Escalier à buffet, chromé
Escalera para buffet, cromada

| art. | dim. cm. | GN | € |
|----------|------------|-----|--------|
| 41403-01 | 31,5x32x48 | 1/3 | 131,66 |



GN

Buffet ladder, chrome plated

Espositore buffet, cromato
Büffet-Leiter, verchromt
Escalier à buffet, chromé
Escalera para buffet, cromada

| art. | dim. cm. | GN | € |
|----------|--------------|-----|--------|
| 41403-02 | 31,5x41,5x48 | 1/2 | 165,42 |





Buffet ladder, chrome plated
Espositore buffet, cromato
Büffet-Leiter, verchromt
Escalier à buffet, chromé
Escalera para buffet, cromada

| art. | dim. cm. | GN | € |
|----------|------------|-----|--------|
| 41403-03 | 31,5x56x66 | 1/2 | 269,94 |



Buffet ladder, chrome plated
Espositore buffet, cromato
Büffet-Leiter, verchromt
Escalier à buffet, chromé
Escalera para buffet, cromada

| art. | dim. cm. | GN | € |
|----------|----------|-----|--------|
| 41403-04 | 52x59x66 | 1/1 | 269,94 |



Multi rack
Multi-distributore
Multi Rack
Distributeur
Dispensador

| art. | dim. cm. | € |
|----------|----------|-------|
| 41911-02 | 19x24x28 | 78,69 |



Multi rack
Multi-distributore
Multi Rack
Distributeur
Dispensador

| art. | dim. cm. | € |
|----------|----------|-------|
| 41911-03 | 19x24x41 | 90,45 |



Multi rack
Multi-distributore
Multi Rack
Distributeur
Dispensador

| art. | dim. cm. | € |
|----------|----------|--------|
| 41911-04 | 19x24x53 | 113,77 |



Canister with lid, glass
Barattolo vetro con coperchio
Vorratsglas
Bocal en verre avec couvercle
Tarro vidrio con tapa

| art. | Ø cm. | h. cm. | lt. | € |
|----------|-------|--------|-----|--------|
| 41590-01 | 11,5 | 16,0 | 0,9 | 110,00 |
| 41590-02 | 14,0 | 21,5 | 2,0 | 17,00 |
| 41590-04 | 18,0 | 26,0 | 4,0 | 27,80 |
| 41590-06 | 20,0 | 30,0 | 6,0 | 32,70 |

Lid with seal. – Tappo con guarnizione.



Canister with lid, glass
Barattolo vetro con coperchio
Vorratsglas
Bocal en verre avec couvercle
Tarro vidrio con tapa

| art. | Ø cm. | h. cm. | lt. | € |
|----------|-------|--------|-----|---|
| 41591-10 | 11 | 18 | 1,0 | - |
| 41591-15 | 12 | 21 | 1,5 | - |

Lid with seal. – Tappo con guarnizione.





W

Cereal-bar

Espositore cereali
Cerealien-Buffer-Ständer
Présentoir à céréales
Expositor de cereales

| art. | dim. cm. | col. | € |
|----------|------------|------|--------|
| 42470-43 | 43x17x13,5 | ● | 161,50 |

3 glasses lt. 2 with airtight cover.
3 vasi lt. 2 con coperchio ermetico.



W

Cereal-bar

Espositore cereali
Cerealienständer
Présentoir à céréales
Expositor de cereales

| art. | dim. cm. | col. | € |
|----------|------------|------|--------|
| 42460-43 | 43x17x13,5 | ● | 161,50 |

3 glasses lt. 2 with airtight cover.
3 vasi lt. 2 con coperchio ermetico.



Jam bar

Espositore marmellate
Konfitürenständer
Présentoir à confitures
Expositor de mermeladas

| art. | dim. cm. | ml. | € |
|----------|------------|-------|-------|
| 41206-05 | 34,5x9x8,5 | 3x176 | 17,09 |



AY

Cereal-bar

Espositore per cereali
Cerealien-Bar
Présentoir à céréales
Expositor de cereales

| art. | dim. cm. | lt. | € |
|----------|------------|-----|-------|
| 41806-03 | 39,5x12x26 | 3x1 | 86,73 |



AY

Cereal pitcher

Caraffa cereali
Cerealienkaraffe
Pichet à céréales
Jarra de cereales

| art. | Ø cm. | dim. cm. | lt. | € |
|----------|-------|----------|-----|-------|
| 41806-00 | 9 | 25,5 | 1 | 27,24 |



NEW

SAN

SS

Cereal dispenser

Distributore di cereali
Cerealienspender
Distributeur à céréales
Dispensador de cereales

| art. | dim. cm. | lt. | € |
|----------|------------|-----|--------|
| 41810B04 | 22x17,5x52 | 4,5 | 140,90 |



SAN

SS

Cereal dispenser

Distributore di cereali
Cerealienspender
Distributeur à céréales
Dispensador de cereales

| art. | dim. cm. | lt. | € |
|----------|------------|-----|--------|
| 41810-04 | 22x17,5x52 | 4,5 | 145,32 |



SAN

SS

Cereal dispenser

Distributore di cereali
Cerealienspender
Distributeur à céréales
Dispensador de cereales

| art. | dim. cm. | lt. | € |
|----------|----------|-------|--------|
| 41810-09 | 22x35x52 | 2x4,5 | 261,70 |



PC

SS

Cereal dispenser

Distributore di cereali
Cerealienspender
Distributeur à céréales
Dispensador de cereales

| art. | dim. cm. | lt. | € |
|----------|----------|-----|--------|
| 41909-08 | 33x24x64 | 7 | 392,65 |



PC

SS

Cereal dispenser

Distributore di cereali
Cerealienspender
Distributeur à céréales
Dispensador de cereales

| art. | dim. cm. | lt. | € |
|----------|----------------|-----|--------|
| 41807-12 | 30,5x28,5x60,5 | 3x4 | 310,65 |



SS

SS

Juice dispenser

Distributore di succhi
Saftdispenser
Distributeur à jus
Dispensador de zumos

| art. | dim. cm. | lt. | € |
|----------|----------|-----|--------|
| 41901-08 | 36x26x55 | 8 | 261,40 |



SS

SS

Juice dispenser duo

Distributore di succhi duo
Saftdispenser duo
Distributeur à jus duo
Dispensador de zumo, doble

| art. | dim. cm. | lt. | € |
|----------|----------|-----|--------|
| 41901-16 | 36x54x55 | 2x8 | 444,31 |



SS

SS

Juice dispenser

Distributore di succhi
Saftdispenser
Distributeur à jus
Dispensador de zumos

| art. | dim. cm. | lt. | € |
|----------|----------|-----|--------|
| 18353-17 | 22x35x56 | 7 | 591,04 |

With 1 cooling unit. – Con 1 eutettico.



SS

SS

Juice dispenser

Distributore di succhi
Saftdispenser
Distributeur à jus
Dispensador de zumos

| art. | dim. cm. | lt. | € |
|----------|----------|-----|--------|
| 41800-05 | 33x22x52 | 5 | 156,48 |



SS

SS

Juice dispenser duo

Distributore di succhi duo
Saftdispenser duo
Distributeur à jus duo
Dispensador de zumo, doble

| art. | dim. cm. | lt. | € |
|----------|--------------|-----|--------|
| 41800-10 | 42,5x30,5x52 | 2x5 | 294,57 |



SS

SS

Milk dispenser

Distributore di latte
Milchkanne
Distributeur à lait
Dispensador de leche

| art. | dim. cm. | lt. | € |
|----------|----------|-----|--------|
| 41801-05 | 33x22x50 | 5 | 316,88 |



W

Cereal dispenser

Distributore di cereali
Cerealienspender
Distributeur à céréales
Dispensador de cereales

| art. | dim. cm. | lt. | col. | € |
|----------|------------|-----|------|--------|
| 42470-45 | 21x20x55,5 | 4,5 | ● | 183,92 |
| 42460-45 | 21x20x55,5 | 4,5 | ● | 183,92 |

Maple/Wenge. – Acero/Wengè.





NEW

Beverage dispenser

Distributore di bevande
Getränkspender
Distributeur de boissons
Dispensador de bebidas

| art. | Ø cm. | h. cm. | lt. | € |
|----------|-------|--------|-----|--------|
| 41808B07 | 20 | 45 | 7 | 132,66 |

Glass container, s/s tap, base and lid black metal. – Contenitore in vetro, rubinetto inox, base e coperchio in metallo nero.



NEW

SS

MF

Drip tray

Griglia raccogli gocce
Tropfenschale
Bac d'égouttage
Rejilla recoge gotas

| art. | Ø cm. | h. cm. | € |
|----------|-------|--------|-------|
| 41808B90 | 9,5 | 1,5 | 13,87 |



W

Juice dispenser

Distributore di succhi
Saftdispenser
Distributeur à jus de fruit
Dispensador de zumo

| art. | dim. cm. | lt. | € |
|----------|----------|-----|-------|
| 41808-04 | 16x24x35 | 4 | 32,06 |



W

Juice dispenser

Distributore di succhi
Saftdispenser
Distributeur à jus de fruit
Dispensador de zumo

| art. | dim. cm. | lt. | col. | € |
|----------|------------|-----|------|--------|
| 42470-74 | 31x20x42 | 4 | ● | 403,31 |
| 42470-76 | 35,5x22x50 | 6 | ● | 470,84 |

Maple. With 2 cooling units. elements, top and base. – Acero. Con 2 eutettici, coperchio e base.



W

Juice dispenser

Distributore di succhi
Saftdispenser
Distributeur à jus de fruit
Dispensador de zumo

| art. | dim. cm. | lt. | col. | € |
|----------|------------|-----|------|--------|
| 42460-74 | 31x20x42 | 4 | ● | 403,31 |
| 42460-76 | 35,5x22x50 | 6 | ● | 470,84 |

Wenge. With 2 cooling units. elements, top and base. – Wengè. Con 2 eutettici, coperchio e base.



W

PR

SS

Milk dispenser

Distributore di latte
Milchkanne
Distributeur à lait
Dispensador de leche

| art. | dim. cm. | lt. | € |
|----------|------------|-----|--------|
| 41900-04 | 23x32x42 | 4 | 489,44 |
| 41900-10 | 27x38,5x45 | 10 | - |

Beechwood. With cooling units.
Faggio. Con eutettici.



SS

PP

Insulated dispenser

Distributore termico
Iso-Dispenser
Distributeur isothermique
Dispensador térmico

| art. | Ø cm. | h. cm. | lt. | € |
|----------|-------|---------|-----|-------|
| 41904-10 | 24 | 42>46,5 | 9,5 | 87,13 |



SS

Air pot

Caraffa termica
Thermopumpkanne
Pot à air isothermique
Jarra térmica

| art. | lt. | € |
|----------|-----|-------|
| 42406-35 | 3,5 | 49,65 |
| 42406-40 | 4,0 | 52,06 |



SS

Air pot

Caraffa termica
Thermopumpkanne
Pot à air isothermique
Jarra térmica

| art. | lt. | € |
|----------|-----|-------|
| 42400-19 | 1,9 | 39,60 |
| 42400-25 | 2,5 | 42,81 |
| 42400-30 | 3,0 | 47,03 |

ATLANTIC BUFFET SYSTEM

BUFFET & PRESENTATION



Conceived and designed in the round and rectangular versions with different opening systems to meet any need ABS Atlantic Buffet System chafing dishes combine contemporary flexibility and functionality. All the parts of these simple-shaped, stackable, 100% stainless steel hygienic items can be easily taken apart for thorough cleaning.

The line comes from the expertise that only Sambonet Paderno can offer to top catering services. The lid is equipped with a new, transparent window made of unbreakable glass that lets you see the delicacies held in the chafing dishes. The gradual closing mechanism and the special lid removal method make the whole System even more effective.

Pensati e ideati nelle versioni rotonde, rettangolari con aperture differenziate per soddisfare ogni esigenza, gli scaldavivande ABS Atlantic Buffet System interpretano la funzionalità e la flessibilità contemporanea. Semplici nella forma, impilabili, igienici poiché realizzati in acciaio inox, facilmente smontabili in tutte le loro parti per una pulizia impeccabile, gli elementi appartenenti alla linea nascono dall'expertise che solo Sambonet Paderno è in grado di garantire alla ristorazione d'eccellenza. Grazie alla trasparenza del nuovo oblò in vetro temperato, i coperchi offrono visibilità alla prelibatezza dei contenuti degli scaldavivande. Il meccanismo di chiusura graduale e lo speciale metodo di rimozione dei coperchi rende ancora più performante l'intero Sistema.



ATLANTIC TOP UNITS - DA APPOGGIO



TOP UNIT - Chafing dish round

Scaldavivande tondo
Chafing Dish, rund
Chafing dish rond
Chafing dish redondo

| art. | Ø cm. | h. cm. | lt. | € |
|----------|-------|--------|-----|--------|
| 18176-30 | 30 | 15 | 2,8 | 586,22 |
| 18176-36 | 36 | 15 | 5,0 | 646,72 |
| 18176-40 | 40 | 17 | 7,8 | 650,03 |



TOP UNIT - Chafing dish round

Scaldavivande tondo
Chafing Dish, rund
Chafing dish rond
Chafing dish redondo

| art. | Ø cm. | h. cm. | lt. | € |
|----------|-------|--------|-----|--------|
| 18176I30 | 30 | 15 | 2,8 | 603,00 |
| 18176I36 | 36 | 15 | 5,0 | 665,11 |
| 18176I40 | 40 | 17 | 7,8 | 668,73 |



TOP UNIT - Chafing dish round

Scaldavivande tondo
Chafing Dish, rund
Chafing dish rond
Chafing dish redondo

| art. | Ø cm. | h. cm. | lt. | € |
|----------|-------|--------|-----|--------|
| 18166-24 | 24 | 15 | 2,0 | 359,49 |
| 18166-30 | 30 | 15 | 2,8 | 464,01 |
| 18166-36 | 36 | 15 | 5,0 | 497,27 |
| 18166-40 | 40 | 17 | 7,8 | 554,46 |



TOP UNIT - Chafing dish round

Scaldavivande tondo
Chafing Dish, rund
Chafing dish rond
Chafing dish redondo

| art. | Ø cm. | h. cm. | lt. | € |
|----------|-------|--------|-----|--------|
| 18166I30 | 30 | 15 | 2,8 | 464,01 |
| 18166I36 | 36 | 15 | 5,0 | 497,27 |
| 18166I40 | 40 | 17 | 7,8 | 554,46 |



TOP UNIT - Chafing dish rectangular

Scaldavivande rettangolare
Chafing Dish, rechteckig
Chafing dish rectangulaire
Chafing dish rectangular

| art. | dim. cm. | lt. | € |
|----------|----------|-----|--------|
| 18172-54 | 57x47x18 | 10 | 981,08 |



TOP UNIT - Chafing dish rectangular

Scaldavivande rettangolare
Chafing Dish, rechteckig
Chafing dish rectangulaire
Chafing dish rectangular

| art. | dim. cm. | lt. | € |
|----------|----------|-----|--------|
| 18162-54 | 57x47x18 | 10 | 756,46 |

ATLANTIC BUILT-IN UNITS - DA INCASSO



BUILT-IN UNIT - Chafing dish rectangular

Scaldavivande rettangolare
Chafing Dish, rechteckig
Chafing dish rectangulaire
Chafing dish rectangular

| art. | dim. cm. | lt. | std | V-W | € |
|----------|----------|-----|-----|---------|----------|
| 18162A55 | 57x47x18 | 10 | | | 904,60 |
| 18162E55 | 57x47x18 | 10 | EU | 250-360 | 1.019,37 |
| 18162U55 | 57x47x18 | 10 | US | 120-450 | 1.057,66 |



| art. | dim. cm. | lt. | std | V-W | € |
|----------|----------|-----|-----|---------|----------|
| 18172A55 | 57x47x18 | 10 | | | 1.155,95 |
| 18172E55 | 57x47x18 | 10 | EU | 250-360 | 1.270,72 |
| 18172U55 | 57x47x18 | 10 | US | 120-450 | 1.309,01 |

ATLANTIC ON STAND UNITS - CON SUPPORTO



Chafing dish, solid alcohol heating

Scaldavivande a combustibile solido
Chafing Dish mit Brennstoff beheizt
Chafing dish chauffage combustible solide
Chafing dish calefacción combustible sólido

| art. | Ø cm. | h. cm. | lt. | € |
|----------|-------|--------|-----|----------|
| 18176A30 | 30 | 27 | 2,8 | 871,94 |
| 18176A36 | 36 | 27 | 5,0 | 1.000,78 |
| 18176A40 | 40 | 28 | 7,8 | 1.129,22 |



Chafing dish, solid alcohol heating

Scaldavivande a combustibile solido
Chafing Dish mit Brennstoff beheizt
Chafing dish chauffage combustible solide
Chafing dish calefacción combustible sólido

| art. | Ø cm. | h. cm. | lt. | € |
|----------|-------|--------|-----|--------|
| 18166A24 | 24 | 27 | 2,0 | 706,31 |
| 18166A30 | 30 | 27 | 2,8 | 829,02 |
| 18166A36 | 36 | 27 | 5,0 | 881,79 |
| 18166A40 | 40 | 28 | 7,8 | 999,17 |



Chafing dish, electric heating

Scaldavivande, riscaldamento elettrico
Chafing Dish, elektrisch beheizt
Chafing dish chauffage électrique
Chafing dish calefacción eléctrica

| art. | Ø cm. | h. cm. | lt. | std | V-W | € |
|----------|-------|--------|-----|-----|---------|----------|
| 18176E30 | 30 | 27 | 2,8 | EU | 250-190 | 1.045,10 |
| 18176E36 | 36 | 27 | 5,0 | EU | 250-190 | 1.166,30 |
| 18176E40 | 40 | 28 | 7,8 | EU | 250-190 | 1.250,72 |
| 18176U36 | 36 | 27 | 5,0 | US | 120-240 | 1.213,74 |
| 18176U40 | 40 | 28 | 7,8 | US | 120-240 | 1.298,16 |





Chafing dish, electric heating
Scaldavivande, riscaldamento elettrico
Chafing Dish, elektrisch beheizt
Chafing dish chauffage électrique
Chafing dish calefacción eléctrica

| art. | Ø cm. | h. cm. | lt. | std | V-W | € |
|----------|-------|--------|-----|-----|---------|----------|
| 18166E24 | 24 | 27 | 2,0 | EU | 250-80 | 855,86 |
| 18166E30 | 30 | 27 | 2,8 | EU | 250-190 | 1.002,19 |
| 18166E36 | 36 | 27 | 5,0 | EU | 250-190 | 1.047,21 |
| 18166E40 | 40 | 28 | 7,8 | EU | 250-190 | 1.120,68 |
| 18166U24 | 24 | 27 | 2,0 | US | 120-170 | 871,74 |
| 18166U36 | 36 | 27 | 5,0 | US | 120-240 | 1.094,75 |
| 18166U40 | 40 | 28 | 7,8 | US | 120-240 | 1.168,21 |



Petite marmite
Petite marmite
Petite marmite
Petite marmite
Petite marmite

| art. | Ø cm. | h. cm. | lt. | std | V-W | € |
|----------|-------|--------|-----|-----|---------|----------|
| 18168A24 | 24 | 35 | 7 | - | - | 855,26 |
| 18168E24 | 24 | 35 | 7 | EU | 250-80 | 1.004,80 |
| 18168U24 | 24 | 35 | 7 | US | 120-170 | 1.020,78 |



Chafing dish rectangular
Scaldavivande rettangolare
Chafing Dish, rechteckig
Chafing dish rectangulaire
Chafing dish rectangular

| art. | dim. cm. | lt. | std | V-W | € |
|----------|------------|-----|-----|---------|----------|
| 18172A54 | 57x47x30,5 | 10 | - | - | 1.467,10 |
| 18172E54 | 57x47x30,5 | 10 | EU | 250-360 | 1.588,60 |
| 18172U54 | 57x47x30,5 | 10 | US | 120-450 | 1.636,04 |



Chafing dish rectangular
Scaldavivande rettangolare
Chafing Dish, rechteckig
Chafing dish rectangulaire
Chafing dish rectangular

| art. | dim. cm. | lt. | std | V-W | € |
|----------|------------|-----|-----|---------|----------|
| 18162A54 | 57x47x30,5 | 10 | - | - | 1.271,02 |
| 18162E54 | 57x47x30,5 | 10 | EU | 250-360 | 1.392,53 |
| 18162U54 | 57x47x30,5 | 10 | US | 120-450 | 1.439,96 |

ASIA LINE



Chafing dish rectangular
Scaldavivande rettangolare
Chafing Dish, rechteckig
Chafing dish rectangulaire
Chafing dish rectangular

| art. | dim. cm. | lt. | std | V-W | € |
|----------|------------|-----|-----|---------|----------|
| 18132A54 | 67,5x44x42 | 10 | - | - | 1.764,98 |
| 18132E54 | 67,5x44x42 | 10 | EU | 250-360 | 1.879,85 |
| 18132U54 | 67,5x44x42 | 10 | US | 120-450 | 1.918,14 |

Chafing dish, to be built in

Scaldavivande da incasso

Einbau Chafing Dish

Chafing dish encastrable

Chafing dish encastrable

| art. | dim. cm. | lt. | std | V-W | € |
|----------|--------------|-----|-----|---------|----------|
| 18132A55 | 67,5x44x34,5 | 10 | - | - | 1.462,98 |
| 18132E55 | 67,5x44x34,5 | 10 | EU | 250-360 | 1.577,85 |
| 18132U55 | 67,5x44x34,5 | 10 | US | 120-450 | 1.616,14 |

Chafing dish round

Scaldavivande tondo

Chafing Dish, rund

Chafing dish rond

Chafing dish redondo

| art. | Ø cm. | h. cm. | lt. | std | V-W | € |
|----------|-------|--------|-----|-----|---------|----------|
| 18136A33 | 33 | 44 | 3,5 | - | - | 1.379,56 |
| 18136E33 | 33 | 44 | 3,5 | EU | 250-200 | 1.540,16 |
| 18136U33 | 33 | 44 | 3,5 | US | 120-240 | 1.544,38 |
| 18136A40 | 40 | 58 | 6,0 | - | - | 1.741,67 |
| 18136E40 | 40 | 58 | 6,0 | EU | 250-360 | 1.856,54 |
| 18136U40 | 40 | 58 | 6,0 | US | 120-450 | 1.894,83 |

Chafing dish round, to be built in

Scaldavivande tondo da incasso

Einbau Chafing Dish, rund

Chafing dish rond encastrable

Chafing dish redondo encastrable

| art. | Ø cm. | h. cm. | lt. | std | V-W | € |
|----------|-------|--------|-----|-----|---------|----------|
| 18136A34 | 33 | 34,5 | 3,5 | - | - | 968,52 |
| 18136E34 | 33 | 34,5 | 3,5 | EU | 250-200 | 1.129,12 |
| 18136U34 | 33 | 34,5 | 3,5 | US | 120-240 | 1.133,34 |
| 18136A41 | 40 | 43,0 | 6,0 | - | - | 1.201,58 |
| 18136E41 | 40 | 43,0 | 6,0 | EU | 250-360 | 1.316,45 |
| 18136U41 | 40 | 43,0 | 6,0 | US | 120-450 | 1.354,74 |

Chafing dish rectangular

Scaldavivande rettangolare

Chafing Dish, rechteckig

Chafing dish rectangulaire

Chafing dish rectangular

| art. | dim. cm. | lt. | std | V-W | € |
|----------|------------|-----|-----|---------|--------|
| 41690A11 | 63,5x35x32 | 8,5 | - | - | 124,12 |
| 41690E11 | 63,5x35x32 | 8,5 | EU | 250-360 | 355,27 |
| 41690U11 | 63,5x35x32 | 8,5 | US | 120-450 | 380,09 |

Chafing dish rectangular

Scaldavivande rettangolare

Chafing Dish, rechteckig

Chafing dish rectangulaire

Chafing dish rectangular

| art. | dim. cm. | lt. | std | V-W | € |
|----------|------------|-----|-----|---------|--------|
| 41691A11 | 71,5x52x45 | 8,5 | - | - | 324,21 |
| 41691E11 | 71,5x52x45 | 8,5 | EU | 250-360 | 565,01 |
| 41691U11 | 71,5x52x45 | 8,5 | US | 120-450 | 589,73 |





Coffee urn
Scaldacaffè
Kaffeedispenser
Réchaud à café
Calentador de café

| art. | dim. cm. | lt. | std | V-W | € |
|----------|--------------|------|-----|---------|--------|
| 41903A10 | 31x33,5x54,5 | 10,5 | - | - | 270,45 |
| 41903E10 | 31x33,5x54,5 | 10,5 | EU | 220-80 | 492,95 |
| 41903U10 | 31x33,5x54,5 | 10,5 | US | 110-170 | 463,91 |



Samovar
Pyramid

| art. | dim. cm. | lt. | Tea pot | std | V-W | € |
|----------|--------------|-----|---------|-----|------|--------|
| 49856-04 | 35,5x30x45,2 | 4 | Lt 1,2 | EU | 2500 | 471,75 |

Teapot with strainer. Cable length approx. 130 cm. With 2 heating elements 2000W and 500W.
Teiera con colino. Lunghezza cavo circa 130 cm. Con 2 resistenze 2000W e 500W.



Samovar
Romanov

| art. | dim. cm. | lt. | Tea pot | std | V-W | € |
|----------|----------|-----|---------|-----|------|--------|
| 49855-05 | 34x27x59 | 5 | Lt 1,3 | EU | 1800 | 924,60 |

Teapot with strainer. Cable length approx. 100 cm. With 2 heating elements 1300W and 500W.
Teiera con colino. Lunghezza cavo circa 100 cm. Con 2 resistenze 1300W e 500W.



Samovar
Soraya

| art. | dim. cm. | lt. | Tea pot | std | V-W | € |
|----------|--------------|-----|---------|-----|------|---|
| 49855-10 | 35,2x44,5x69 | 10 | Lt 1,6 | EU | 3000 | - |

Teapot with strainer. Cable length approx. 130 cm. With 2 heating elements 2300W and 700W.
Teiera con colino. Lunghezza cavo circa 130 cm. Con 2 resistenze 2300W e 700W.



Samovar
Katharina

| art. | dim. cm. | lt. | Tea pot | std | V-W | € |
|----------|----------------|-----|---------|-----|------|----------|
| 49855-15 | 39,5x44,5x74,5 | 15 | Lt 2,0 | EU | 3000 | 2.339,84 |

Teapot with strainer. Cable length approx. 130 cm. With 2 heating elements 2300W and 700W.
Teiera con colino. Lunghezza cavo circa 130 cm. Con 2 resistenze 2300W e 700W.



Coffee percolator
Percolatore per caffè
Kaffee-Perkolator
Percolateur à café
Percolator de café

| art. | Ø cm. | h. cm. | lt. | std | V-W | € |
|----------|-------|--------|-----|-----|------|--------|
| 49846-05 | 28 | 38,5 | 4,5 | EU | 950 | 257,68 |
| 49846-09 | 28 | 38,5 | 9,2 | EU | 950 | 308,74 |
| 49846-15 | 33 | 54 | 15 | EU | 1650 | 354,36 |



Soup kettle
Zuppiera
Suppenwärmer
Marmite à soupe
Olla de sopa

| art. | Ø cm. | h. cm. | lt. | std | V-W | € |
|----------|-------|--------|-----|-----|-------------|--------|
| 49847-38 | 38 | 36,5 | 10 | EU | 230-450/550 | 259,89 |



Soup kettle
Zuppiera
Suppenwärmer
Marmite à soupe
Olla de sopa

| art. | Ø cm. | h. cm. | lt. | std | V-W | € |
|----------|-------|--------|-----|-----|---------|--------|
| 49847-08 | 33 | 37 | 10 | EU | 230-400 | 104,12 |



Soup kettle
Zuppiera
Suppenkessel
Marmite à soupe
Olla de sopa

| art. | Ø cm. | h. cm. | lt. | € |
|----------|-------|--------|-----|--------|
| 49790-09 | 48 | 32 | 10 | 708,73 |



ACCESSORIES, SPARE PARTS AND COMPONENTS



Induction cooker, to be built into counter
Piastra ad induzione, da incasso
Induktionsplatte, thekeneinbau
Plaque à induction, montage en comptoir
Placa a inducción para emportar

| art. | std | dim. cm. | € |
|----------|-----|------------|--------|
| 18162-RB | EU | 36X38x12,5 | 501,60 |

Schott ceran hob, timer (0-180 min.), 1-10 power levels, temperature range 60°C-240°C. – Piano in vetroceramica Schott, timer 0-180 minuti, 1-10 livelli di potenza, temperatura 60-240°C.



Induction cooker
Piastra ad induzione
Induktionsplatte
Plaque à induction
Placa a inducción

| art. | std | dim. cm. | € |
|----------|-----|----------|--------|
| 18162-RA | EU | 30X37x10 | 303,81 |

Stainless steel body, Schott ceran hob, led display, timer (0-180 min.), 1-10 power levels, temperature range 60°C-240°C. – Corpo inox, piano in vetroceramica Schott, display a led, timer 0-180 minuti, 1-10 livelli di potenza, temperatura 60-240°C.



Induction station
Postazione induzione
Induktionsstation
Station d'induction
Estación inducción

| art. | std | dim. cm. | € |
|----------|-----|------------------|--------|
| 49999-04 | EU | 35,4x32,5x19 900 | 354,36 |

Induction plate with temperature regulator 60>140°C. Black metal support, walnut wood insert and stainless steel frame. – Piastra a induzione con regolatore di temperatura 60>140°C. Supporto in metallo nero, inserto in legno di noce e cornice inox.



Round stand
Supporto rotondo
Gestell, rund
Support rond
Soporte redondo

| art. | Ø cm. | € |
|----------|-------|--------|
| 18166-AA | 24 | 290,85 |
| 18166-AM | 30 | 315,27 |
| 18166-AB | 36 | 318,59 |
| 18166-AC | 40 | 339,39 |



Rectangular stand
Supporto rettangolare
Gestell, rechteckig
Support rectangulaire
Soporte rectangulare

| art. | dim. cm. | € |
|----------|----------|--------|
| 18162-AA | 57x47 | 398,88 |



Soup tureen without lid
Zuppiera senza coperchio
Suppensüssel ohne Deckel
Soupière sans couvercle
Sopera sin tapa

| art. | Ø cm. | lt. | € |
|----------|-------|-----|--------|
| 18168-GA | 24 | 7 | 208,14 |

Round food pan, stainless steel

Portavivande tondo, inox
Einsatzbehälter, rund, Edelstahl Rostfrei
Bac rond, inox
Baño-maria redondo, inox

| art. | Ø cm. | h. cm. | lt. | € |
|----------|-------|--------|-----|--------|
| 18136-EA | 33 | 6,0 | 3,5 | 95,37 |
| 18136-EB | 40 | 7,5 | 6,0 | 112,76 |

For ASIA round chafing dishes.
Per scaldavivande ASIA tondi.

Round food pan, stainless steel

Portavivande tondo, inox
Einsatzbehälter, rund, Edelstahl Rostfrei
Bac rond, inox
Baño-maria redondo, inox

| art. | Ø cm. | € |
|----------|-------|-------|
| 18166-EG | 24 | 49,75 |
| 18166-EM | 30 | 62,31 |
| 18166-EH | 36 | 71,76 |
| 18166-EI | 40 | 87,84 |

For ABS round chafing dishes.
Per scaldavivande ABS tondi.

Round porcelain insert

Inserto tondo, porcellana
Porzellaneinsatz, rund
Bac rond, porcelaine
Baño-maria redondo, porcelana

| art. | Ø cm. | h. cm. | € |
|----------|-------|--------|--------|
| 44352-30 | 33 | 5,7 | 106,33 |
| 44352-40 | 40 | 7,5 | 141,81 |

For ASIA round chafing dishes.
Per scaldavivande ASIA tondi.

Round porcelain insert, 2 food sections

Inserto tondo, porcellana, 2 scomparti
Porzellaneinsatz 2-tlg., rund
Bac rond, porcelaine, 2 compartements
Baño-maria redondo, porcelana 2 compartimentos

| art. | Ø cm. | h. cm. | € |
|----------|-------|--------|--------|
| 44355-30 | 37 | 7,5 | 110,65 |
| 44355-40 | 43 | 7,5 | 175,77 |

For ASIA round chafing dishes cm 33-40.
Per scaldavivande ASIA tondi cm 33-40.

Round porcelain insert

Inserto tondo, porcellana
Porzellaneinsatz, rund
Bac rond, porcelaine
Baño-maria redondo, porcelana

| art. | Ø cm. | € |
|----------|-------|--------|
| 18166-EL | 30 | 102,21 |
| 18166-EC | 36 | 100,40 |
| 18166-EB | 40 | 121,81 |

For ABS round chafing dishes.
Per scaldavivande ABS tondi.

Round porcelain insert, 2 food sections

Inserto tondo, porcellana, 2 scomparti
Porzellaneinsatz 2-tlg., rund
Bac rond, porcelaine, 2 compartements
Baño-maria redondo, porcelana 2 compartimentos

| art. | Ø cm. | € |
|----------|-------|--------|
| 18166-ED | 36 | 111,05 |
| 18166-EJ | 40 | 138,09 |

For ABS round chafing dishes.
Per scaldavivande ABS tondi.

Food pan GN 1/1, stainless steel

Bacinella GN 1/1, inox
GN-Behälter 1/1, Edelstahl Rostfrei
Bac GN 1/1, inox
Baño-maria GN 1/1, inox

| art. | dim. cm. | € |
|----------|-------------|-------|
| 14102-04 | 53x32,5x4 | 20,90 |
| 14102-06 | 53x32,5x6,5 | 25,23 |

Food pan GN 1/1, porcelain

Bacinella GN 1/1, porcellana
GN-Behälter 1/1, Porzellan
Bac GN 1/1, porcelaine
Baño-maria GN 1/1, porcelana

| art. | dim. cm. | € |
|----------|-------------|--------|
| 44332-03 | 53x32,5x2 | 119,09 |
| 44332-06 | 53x32,5x6,5 | 126,83 |

Fuel Holder, stainless steel

Portacombustibile, inox
Brennstoffhalterung, Edelstahl Rostfrei
Porte Brûleur, inox
Contenedor de combustible, inox

| art. | Ø cm. | h. cm. | € |
|----------|-------|--------|------|
| 41809-09 | 9 | 6,5 | 9,55 |

Suitable for chafing dishes items 41690 and 41691. – Adatto per gli scaldavivande art. 41690 e 41691.

Fuel Holder, stainless steel

Portacombustibile, inox
Brennstoffhalterung, Edelstahl Rostfrei
Porte Brûleur, inox
Contenedor de combustible, inox

| art. | Ø cm. | h. cm. | € |
|----------|-------|--------|-------|
| 18132-FB | 10 | 7,5 | 36,18 |

Suitable for chafing dishes items 18152 and 18156. – Adatto per gli scaldavivande art. 18152 e 18156.

Fuel Holder, stainless steel

Portacombustibile, inox
Brennstoffhalterung, Edelstahl Rostfrei
Porte Brûleur, inox
Contenedor de combustible, inox

| art. | € |
|----------|-------|
| 18136-KA | 88,54 |

Kit for ABS round ø cm 24-30-36. – Set per scaldavivande ABS ø cm 24-30-36.

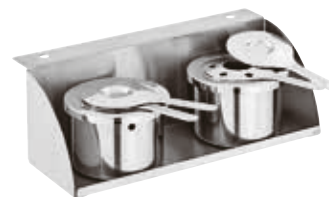
Fuel Holder, stainless steel

Portacombustibile, inox
Brennstoffhalterung, Edelstahl Rostfrei
Porte Brûleur, inox
Contenedor de combustible, inox

| art. | € |
|----------|--------|
| 18132-KA | 132,56 |

Kit for ABS rectangular and round ø cm 40. – Set per scaldavivande ABS rettangolari e ø cm 40.



Jelly fuel

Gel combustibile
Brenngel
Gel combustible
Combustible gel

| art. | lt. | gr. | € |
|----------|-----|-----|-------|
| 41695-15 | - | 200 | 2,21 |
| 41695-10 | 1 | - | 9,15 |
| 41695-50 | 5 | - | 40,50 |



Thermoregulator

Termoregolatore
Thermoregler
Thermorégulateur
Termorregulador

| art. | std | € |
|----------|-----|-------|
| 18132-AE | EU | 95,78 |

For rectangular and round units ø cm 30-33-36-40. – Per scaldavivande rettangolari e tondi ø cm 30-33-36-40.



Thermoregulator

Termoregolatore
Thermoregler
Thermorégulateur
Termorregulador

| art. | std | € |
|----------|-----|-------|
| 18132-AU | US | 97,89 |

For rectangular and round units ø cm 30-33-36-40. – Per scaldavivande rettangolari e tondi ø cm 30-33-36-40.



Electric heating units

Piastre elettriche
Elektro-Heizelemente
Corps de chauffe électriques
Calentadores eléctricos

| art. | std | V-W | € |
|----------|-----|---------|--------|
| 18136-KE | EU | 220-200 | 249,14 |
| 18136-KU | US | 110-240 | 253,36 |

Cm. 20x20 - For ASIA round chafing dishes cm 33. – Per scaldavivande ASIA tondo cm 33.



Electric heating units

Piastre elettriche
Elektro-Heizelemente
Corps de chauffe électriques
Calentadores eléctricos

| art. | std | V-W | € |
|----------|-----|---------|--------|
| 18166-KP | EU | 220-180 | 261,70 |

Cm. 20x21 - For ABS round ø cm 30.
Per scaldavivande ABS tondo ø cm 30.



Electric heating units

Piastre elettriche
Elektro-Heizelemente
Corps de chauffe électriques
Calentadores eléctricos

| art. | std | V-W | € |
|----------|-----|---------|--------|
| 18166-KE | EU | 220-200 | 253,96 |
| 18166-KU | US | 110-240 | 301,50 |

Cm. 20x25 - For ABS round ø cm 36-40.
Per scaldavivande ABS tondo ø cm 36-40.



Electric heating units

Piastre elettriche
Elektro-Heizelemente
Corps de chauffe électriques
Calentadores eléctricos

| art. | std | V-W | € |
|----------|-----|---------|--------|
| 18132-KE | EU | 220-380 | 247,33 |
| 18132-KU | US | 110-450 | 285,62 |

Cm. 20x25 - For ASIA rectangular and round chafing dishes cm 40. – Per scaldavivande ASIA rettangolari e tondi cm 40.



Electric heating units

Piastre elettriche
Elektro-Heizelemente
Corps de chauffe électriques
Calentadores eléctricos

| art. | std | V-W | € |
|----------|-----|---------|--------|
| 18162-KE | EU | 220-380 | 253,96 |
| 18162-KU | US | 110-450 | 301,50 |

Cm. 20x25 - For ABS rectangular.
Per scaldavivande ABS rettangolari.



Electric heating units

Piastre elettriche
Elektro-Heizelemente
Corps de chauffe électriques
Calentadores eléctricos

| art. | std | V-W | € |
|----------|-----|---------|--------|
| 18341-KE | EU | 220-60 | 238,08 |
| 18341-KU | US | 110-170 | 253,96 |

Cm. Ø 13,5 - For ABS round ø cm 24.
Per scaldavivande ABS tondo ø cm 24.

DINING ROOM TROLLEYS CARRELLI SALA

BUFFET



PP

Serving trolley

Carrello servizio

Servierwagen

Chariot à servir

Carro de servicio

| art. | dim. cm. | col. | € |
|----------|----------|------|--------|
| 49995-04 | 97x51x99 | ● | 786,71 |

Swivel casters for easy manoeuvrability. Ergonomic handles, high load capacity 135 kg (45 kg per shelf). Ultra-quiet mark-resistant casters. – Maniglie ergonomiche arrotondate, pannelli laterali e bordo paraurti arrotondato. Portata 135 kg (45 kg per ripiano). Ruote girevoli, antitraccia e silenziose.



NEW SERVICE CONCEPT



2-tier service trolleys with hygienic plexiglas dome cover double side opening and 4 standard swivel wheels, 2 with brake. A new way of serving food safely and fighting COVID 19 by clearly dividing the kitchen side and the service side to avoid contamination and have the most hygienic service possible.

Carrelli di servizio a 2 piani dotati di cupola igienica in plexiglas apribile sui 2 lati e 4 ruote girevoli di cui 2 con freno. Un nuovo modo di servire gli alimenti in sicurezza e combattere COVID 19 dividendo chiaramente il lato cucina e il lato servizio per evitare contaminazioni e avere il servizio più igienico possibile.



Serving trolley

Carrello servizio
Servierwagen
Chariot à servir
Carro de servicio

| art. | dim. cm. | € |
|----------|-----------|----------|
| 49996-00 | 89x47x103 | 1.362,18 |

Chromed structure, shelves elm color, perimeter barrier lower deck, sliding plate shelf upper deck, wheels Ø 100 mm.

Struttura cromata, ripiani color olmo, spondine di contenimento piano inferiore, pianetto estraibile, ruote Ø 100 mm.



Serving trolley

Carrello servizio
Servierwagen
Chariot à servir
Carro de servicio

| art. | dim. cm. | € |
|----------|-----------|----------|
| 49996-01 | 89x47x103 | 1.195,35 |

Chromed structure, shelves elm color, wheels Ø 100 mm.

Struttura cromata, ripiani color olmo, ruote Ø 100 mm.



Serving trolley

Carrello servizio
Servierwagen
Chariot à servir
Carro de servicio

| art. | dim. cm. | € |
|----------|-----------|---|
| 49996-05 | 89x47x103 | - |

Painted structure, shelves grey color, wheels Ø 100 mm.

Struttura verniciata, ripiani colore grigio, ruote Ø 100 mm.





A range of service tables and trolleys designed to allow guests to comfortably and safely receive and consume breakfast or dinner in their room. Hot boxes made of AISI 304 stainless steel with double insulated wall. Analog thermostat 30-90°C with indicator light. Equipped with two inner height-adjustable grids. Suitable for dishes up to Ø 32 cm. Refrigerated boxes made of AISI 304 stainless steel with double insulated wall with chilling pack -32°C inserted in a condensate collector basket placed on the upper grid. Chill for about 5 hours. Room service tables: chromes tube structure, 2 castors with brake. Top Ø 90 cm made of CDF (Compact Density Fibreboard). Can carry up to 2 boxes.

Una gamma di tavoli e carrelli per il servizio in camera per permettere agli ospiti di ricevere e consumare comodamente e in piena sicurezza la colazione o la cena in stanza. Box termici in acciaio inox AISI 304 a doppia parete coibentata. Termostato analogico 30-90°C con spia luminosa di funzionamento. Forniti con due griglie interne regolabili in altezza. Idonei per piatti fino a Ø 32 cm. Box refrigerati in acciaio inox AISI 304 a doppia parete coibentata. Refrigerazione a mezzo di una piastra eutettica -32°C inserita in un cesto di raccolta posizionato sulla griglia superiore. Raffreddare per c.ca 5 ore. Tavolini: struttura in tubo cromato, 2 ruote con freno. Piano Ø 90 cm in CDF (Compact Density Fibreboard). Possono trasportare fino a 2 box.



Thermic hot box

Box termico
Speisen-Kaste
Caisson thermique
Cajón térmico

| art. | dim. cm. | W | € |
|----------|--------------|-----|----------|
| 44094-00 | 38x40,5x51,2 | 500 | 1.038,67 |

Refrigerated box

Box refrigerato
Speisen-Kaste
Caisson réfrigéré
Cajón refrigerado

| art. | dim. cm. | € |
|----------|------------|--------|
| 44094R00 | 38x40,5x51 | 956,36 |



ROOM SERVICE



Room service table

Tavolino room service
Zimmerservice-Tisch
Table de restauration en chambre
Carrito de servicio de habitaciones

| art. | Ø cm. | h. cm. | closed/chiuso | € |
|----------|---------|--------|---------------|----------|
| 44094-03 | 90/54,6 | 78,6 | 74x54x117 | 1.338,06 |

With fold down flaps for easy crossing of doors and lifts. With capsizable top for stacking when not in use. – Con flaps pieghevoli per attraversare porte e ascensori. Ribaltabile e impilabile quando non in uso.



Room service table with hot box

Tavolino room service con hot box
Zimmerservice-Tisch mit Hot Box
Table de restauration en chambre avec hot box
Carrito de servicio de habitaciones con hot box

| art. | Ø cm. | h. cm. | W | € |
|----------|---------|--------|-----|----------|
| 44094-04 | 90/54,6 | 78,6 | 500 | 2.352,50 |

44094-00 + 44094-03.



Serving trolley

Carrello servizio
Servierwagen
Chariot à servir
Carro de servicio

| art. | des. | dim. cm. | € |
|----------|----------|--------------|----------|
| 49996-01 | trolley | 89x47x103 | 1.195,35 |
| 44094-00 | hot box | 38x40,5x51,2 | 1.038,67 |
| 44094R00 | cold box | 38x40,5x51 | 956,36 |

With hygienic plexiglas dome cover double side opening. The trolley can be equipped with 2 hot and/or cold boxes. Ideal for maintaining the temperature of food and for the room service. – Cupola igienica in plexiglas apribile sui 2 lati. Il carrello è equipaggiabile con 2 box termici caldi e/o freddi. Ideale per mantenere la temperatura delle portate e per il servizio in camera.



Serving trolley

Carrello servizio
Servierwagen
Chariot à servir
Carro de servicio

| art. | des. | dim. cm. | € |
|----------|----------|--------------|----------|
| 49996-05 | trolley | 89x47x103 | - |
| 44094-00 | hot box | 38x40,5x51,2 | 1.038,67 |
| 44094R00 | cold box | 38x40,5x51 | 956,36 |

With hygienic plexiglas dome cover double side opening. The trolley can be equipped with 2 hot and/or cold boxes. Ideal for maintaining the temperature of food and for the room service. – Con cupola igienica in plexiglas apribile sui 2 lati. Il carrello è equipaggiabile con 2 box termici caldi e/o freddi. Ideale per mantenere la temperatura delle portate e per il servizio in camera.



Breakfast tray with legs

Vassoio colazione con gambe
Frühstückstablett mit Beinen
Plateau petit déjeuner avec jambes
Bandeja desayuno con patas

| art. | dim. cm. | col. | € |
|----------|--------------|------|-------|
| 19902-38 | 58,5x38,5x30 | ● | 73,26 |

Wengè.



Room service tray

Vassoio room service
Zimmerservice-Tablett
Plateau room-service
Bandeja room service

| art. | dim. cm. | col. | € |
|----------|----------|------|-------|
| 19901-35 | 52x35 | ● | 39,80 |
| 19901-40 | 60x40 | ● | 45,02 |
| 19901-47 | 71x47 | ● | 61,41 |

Dark walnut. – Noce scuro.

SERIES 14000

STORAGE & TRANSPORT
STOCCAGGIO E TRASPORTO



Molded in one-piece with double-wall construction made of polypropylene. Resistant to shock, high temperatures and chemicals. Designed to give optimum protection to glass and chinaware as well as to maximise water circulation and drying in professional dishwasher. Easy and quickly stackable without tools or screws. Base racks have comfortable hand grips on all four sides facilitating handling.

Realizzati in polipropilene, stampati unipezzo a doppio spessore. Resistenti agli urti ed alte temperature, agenti chimici e residui alimentari. Concepiti per assicurare una protezione ottimale a bicchieri e stoviglie, il loro design permette inoltre una perfetta circolazione dell'acqua di lavaggio ed una rapida e perfetta asciugatura. Facili e veloci da impilare. Leggeri e maneggevoli, tutti i cestelli di base sono dotati di maniglie integrali su tutti i lati.





9-Compartment base

Cestello 9 bicchieri
Grundkorb für 9 Gläser
Panier de base 9 verres
Cesta 9 compartimentos

| art. | mm. | € |
|----------|-------------|-------|
| 14001-09 | 500x500x103 | 21,41 |

**Compartments / Scosparti 151x151x42 mm.
ø max 151 mm.**



9-Compartment extender

Estensore per cestello 9 bicchieri
Aufsatz zum Grundkorb für 9 Gläser
Réhausse pour panier de base 9 verres
Extensión 9 compartimentos

| art. | mm. | € |
|----------|------------|-------|
| 14003-09 | 500x500x45 | 10,85 |

**Compartments / Scosparti 151x151x88 mm.
ø max 151 mm.**



16-Compartment base

Cestello 16 bicchieri
Grundkorb für 16 Gläser
Panier de base 16 verres
Cesta 16 compartimentos

| art. | mm. | € |
|----------|-------------|-------|
| 14001-16 | 500x500x103 | 23,52 |

**Compartments / Scosparti 112x112x88 mm.
ø max 112 mm.**



16-Compartment extender

Estensore per cestello 16 bicchieri
Aufsatz zum Grundkorb für 16 Gläser
Réhausse pour panier de base 16 verres
Extensión 16 compartimentos

| art. | mm. | € |
|----------|------------|-------|
| 14003-16 | 500x500x45 | 10,85 |

**Compartments / Scosparti 112x112x42 mm.
ø max 112 mm.**



25-Compartment base

Cestello 25 bicchieri
Grundkorb für 25 Gläser
Panier de base 25 verres
Cesta 25 compartimentos

| art. | mm. | € |
|----------|-------------|-------|
| 14001-25 | 500x500x103 | 25,13 |

**Compartments / Scosparti 88x88x88 mm.
ø max 88 mm.**



25-Compartment extender

Estensore per cestello 25 bicchieri
Aufsatz zum Grundkorb für 25 Gläser
Réhausse pour panier de base 25 verres
Extensión 25 compartimentos

| art. | mm. | € |
|----------|------------|-------|
| 14003-25 | 500x500x45 | 10,85 |

**Compartments / Scosparti 88x88x42 mm.
ø max 88 mm.**



36-Compartment base

Cestello 36 bicchieri
Grundkorb für 36 Gläser
Panier de base 36 verres
Cesta 36 compartimentos

| art. | mm. | € |
|----------|-------------|-------|
| 14001-36 | 500x500x103 | 26,23 |

**Compartments / Scosparti 73x73x88 mm.
ø max 73 mm.**



36-Compartment extender

Estensore per cestello 36 bicchieri
Aufsatz zum Grundkorb für 36 Gläser
Réhausse pour panier de base 36 verres
Extensión 36 compartimentos

| art. | mm. | € |
|----------|------------|-------|
| 14003-36 | 500x500x45 | 10,85 |

**Compartments / Scosparti 73x73x42 mm.
ø max 73 mm.**



49-Compartment base

Cestello 49 bicchieri
Grundkorb für 49 Gläser
Panier de base 49 verres
Cesta 49 compartimentos

| art. | mm. | € |
|----------|-------------|-------|
| 14001-49 | 500x500x103 | 27,24 |

**Compartments / Scosparti 62x62x42 mm.
ø max 62 mm.**



49-Compartment extender
 Estensore per cestello 49 bicchieri
 Aufsatz zum Grundkorb für 49 Gläser
 Réhausse pour panier de base 49 verres
 Extensión 49 compartimentos

| art. | mm. | € |
|----------|------------|-------|
| 14003-49 | 500x500x45 | 10,85 |

**Compartments / Scomparti 62x62x42 mm.
 ø max 62 mm.**



Open extender
 Estensore aperto
 Universalrand ohne Einteilung
 Réhausse sans cloisons
 Extensión abierta

| art. | mm. | € |
|----------|------------|-------|
| 14004-00 | 500x500x42 | 10,85 |



Rack cover
 Coperchio per cestelli
 Deckel für Körbe
 Couvrecle à panier
 Tapa para cestas

| art. | mm. | € |
|----------|------------|-------|
| 14011-00 | 505x505x25 | 15,48 |



Open rack
 Cestello universale
 Universal-Korb
 Panier universel
 Cesta universal

| art. | mm. | € |
|----------|-------------|-------|
| 14010-00 | 500x500x103 | 20,10 |



Cutlery rack
 Cestello per posate
 Besteckkorb
 Panier à couverts
 Cesta para cubiertos

| art. | mm. | € |
|----------|-------------|-------|
| 14006-00 | 500x500x103 | 19,60 |



Plates & trays rack
 Cestello per piatti e vassoio
 Tablett- u. Tellerkorb mit Fingern
 Panier à plateaux et assiettes
 Cesta para bandejas y platos

| art. | mm. | € |
|----------|-------------|-------|
| 14008-00 | 500x500x103 | 20,10 |

**For 18 flat plates or 9 trays max. 460 mm.
 Per 18 piatti piani oppure 9 vassoio max. 460 mm.**



Tray rack, open
 Cestello per vassoio, aperto
 Tablettkorb mit Fingern, offen
 Panier à plateaux, ouvert
 Cesta abierto para bandejas

| art. | mm. | € |
|----------|-------------|-------|
| 14007-00 | 500x500x103 | 24,12 |

**For trays over 460 mm. Capacity 9 pcs.
 Per vassoio oltre 460 mm. Cap. 9 pz.**



Clip tags, 10-pcs set
 Etichette di identificazione, set 10 pz
 Markierungsklipp, 10 Stk.
 Clips, set 10 pièces
 Etiquetas, set 10 piezas

| art. | mm. | € |
|----------|-------|------|
| 14013-00 | 80x40 | 8,34 |



Cutlery holder 8 compartments
 Cestello per posate 8 scomparti
 Besteckkorb, 8 Unterteilungen
 Panier à couverts 8 compartiments
 Cesta para cubiertos

| art. | mm. | € |
|----------|-------------|-------|
| 14015-08 | 426x206x150 | 12,96 |

For 200/250 pcs cutlery. – Per 200/250 posate.





SS

Cutlery holder

Cestello porta posate
Besteckbehälter
Réceptient à couverts
Cestillo para cubiertos

| art. | Ø cm. | h. cm. | € |
|----------|-------|--------|-------|
| 42586-10 | 10 | 14 | 19,10 |



PE

Cutlery holder

Cestello porta posate
Besteckbehälter
Réceptient à couverts
Cestillo para cubiertos

| art. | Ø cm. | h. cm. | € |
|----------|-------|--------|------|
| 42586-09 | 9,5 | 13,5 | 2,41 |



PP

Cutlery dispenser

Porta posate
Besteckbehälter
Réceptient à couverts
Contenedor para cubiertos

| art. | cm. | € |
|----------|----------|-------|
| 42585-06 | 54x33x13 | 13,07 |



PE

Cutlery dispenser

Porta posate
Besteckbehälter
Réceptient à couverts
Contenedor para cubiertos

| art. | cm. | GN | h. cm. | € |
|----------|---------|-----|--------|-------|
| 42585-04 | 32,5x53 | 1/1 | 10 | 13,17 |



PP

Cutlery box lid

Coperchio per porta posate
Deckel für Besteckbehälter
Couvercle pour réceptient à couverts
Tapa para contenedor cubiertos

| art. | cm. | € |
|----------|-----------|------|
| 42585-00 | 32,5x53x2 | 5,43 |

Fits/Per: 42585-04.



Dolly with handle

Carrello con maniglione
Transportwagen mit Griff
Chariot avec poignée
Carretilla con manillar

| art. | cm. | Kg. | € |
|----------|----------|-----|--------|
| 44023-00 | 54x54x75 | 10 | 178,19 |

Polypropylene base. – Base in PP.



Dolly without handle

Carrello senza maniglione
Transportwagen ohne Griff
Chariot sans poignée
Carretilla sin manillar

| art. | cm. | Kg. | € |
|----------|-------|-----|--------|
| 44024-00 | 54x54 | 8,5 | 132,96 |

Polypropylene base. – Base in PP.



Dolly, aluminum/ABS

Carrello, alluminio/ABS
Transportwagen, Aluminium/ABS
Chariot, aluminium/ABS
Carro, aluminio/ABS

| art. | cm. | € |
|----------|-------|--------|
| 44975C50 | 51x51 | 228,74 |



SS

Dolly with handle

Carrello con maniglione
Transportwagen mit Griff
Chariot avec poignée
Carretilla con manillar

| art. | cm. | € |
|----------|---------|--------|
| 44025-50 | 55x55x9 | 344,82 |

**Removable handle, with drip and drain plug.
Load 60 kg. – Manico estraibile, tappo di scarico.
Carico 60 kg.**



Dust cover

Copertura protettiva
Schutzhülle
Housse de protection
Cuberta protectora

| art. | cm. | € |
|----------|-----------|-------|
| 44009-00 | 55x55x122 | 13,27 |



Trolley 3 levels

Carrello 3 livelli
3-stöckiger Wagen
Chariot à 3 étages
Carro 3 pisos

| art. | cm. | € |
|----------|--------------|----------|
| 44020-21 | 100x50x178,5 | 1.400,27 |

Suitable for 24 racks.
Carico verticale per 24 cestelli.

SS



PP

Multipurpose box

Recipiente
Behälter
Conteneur multiservice
Contenedor

| art. | cm. | € |
|----------|------------|-------|
| 44031-04 | 52x39x12,7 | 13,87 |
| 44031-05 | 52x39x17,7 | 14,97 |

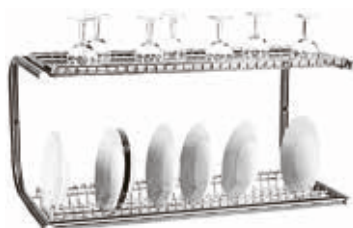

SS

Wall draining rack

Scolapiatti a muro
Wand-Trockengestell
Egouttoir au mur
Escurridor mural de platos

| art. | cm. | € |
|----------|----------|---|
| 44029-00 | 87x30x20 | - |

Load/Carico: 70 kg.



Wire dish rack

Porta piatti in filo metallo/rislan
Tellergestell
Porte-assiettes
Porta platos

| art. | Ø cm. | h. cm. | € |
|----------|-------|--------|-------|
| 44047-17 | 17 | 30 | 51,26 |
| 44047-19 | 19 | 30 | 54,97 |
| 44047-22 | 22 | 30 | 60,60 |
| 44047-25 | 25 | 30 | 64,02 |
| 44047-28 | 28 | 30 | 67,84 |



SS

Dish dolly

Carrello portapiatti
Teller-Transportwagen
Chariot porte-assiettes
Carro porta platos

| art. | cm. | € |
|----------|----------|----------|
| 44027-00 | 74x61x81 | 1.411,92 |

Load/Carico max: 240 kg.



PE

Adjustable dish dolly

Carrello portapiatti regolabile
Teller-Transportwagen, einstellbar
Chariot de stockage d'assiettes réglable
Carro ajustable para platos

| art. | cm. | Kg. | € |
|----------|----------|-----|----------|
| 49304-06 | 73x73x82 | 28 | 1.484,49 |

With dust cover and 4 dividers. Dishes Ø cm 18-32,5 capacity 180/480 pcs. 2 wheels with brake.
Con copertura vinilica e 4 divisori. Per piatti Ø cm 18-32, capienza 180/480 pz. 2 ruote con freno.

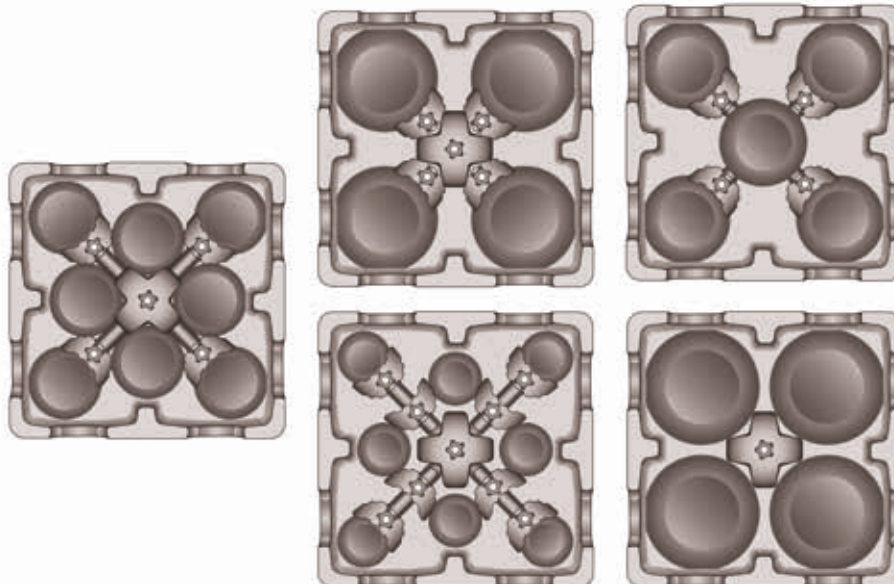

CROCKERY TRANSPORT BOX
CONTENITORE PER IL TRASPORTO DI STOVIGLIE

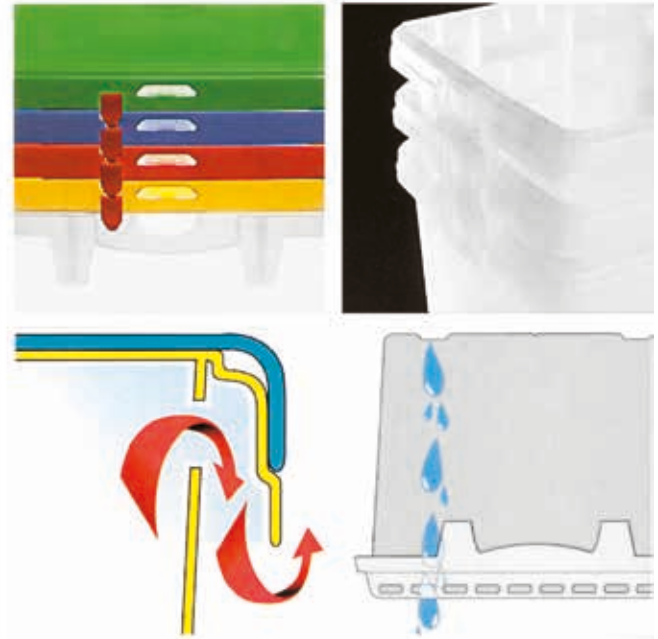

Clear polypropylene construction, full compliance with food contact requirements. A removable tower insert provides total flexibility. Strong, it prevents dish breakage in transport. Dimensions suitable to EURO-pallets. Lids are tightly fitting, hygienic, dish-washer safe. Covers available in different colors, assure easy and quick content identification. Stackable once empty, their strongness provides high loading density once full. Ventilation holes assure constant air circulation. Design studied to enable water flow while washing.

Contenitori in polipropilene trasparente per alimenti. Estremamente resistenti alle sollecitazioni, offrono protezione sicura nel trasporto. Dimensioni adatte a EURO-pallets. Adatti al lavaggio in lavastoviglie, design studiato per consentire il defluire dell'acqua. Coperchi di colore diverso facilitano l'individuazione del contenuto. Impilabili, a pieno la loro robustezza consente un'elevata capacità di sovrapposizione. Fessure di aerazione per un costante ricambio d'aria.



Storage box
Contenitore
Korb
Panier
Contenedor

| art. | cm. | lt. | € |
|----------|------------|-----|-------|
| 44040-40 | 40x40x31,5 | 32 | 45,93 |



Base insert
Fondo piatto
Flach-Einsatz
Plateau double fond
Base plana

| art. | cm. | € |
|----------|-------|------|
| 44042-00 | 40x40 | 3,72 |



Cross insert
Inserto croce
Kreuz-Einsatz
Cloison à croix
Separador a cruz

| art. | cm. | € |
|----------|-------|------|
| 44043-00 | 40x40 | 6,83 |



Cover
Coperchio
Deckel
Couvercle
Tapa

| art. | col. | € |
|----------|------|-------|
| 44041-00 | ○ | 17,39 |
| 44041-01 | ● | 17,39 |
| 44041-03 | ● | 17,39 |



Cover
Coperchio
Deckel
Couvercle
Tapa

| art. | col. | € |
|----------|------|-------|
| 44041-04 | ● | 17,39 |
| 44041-05 | ● | 17,39 |



Tower insert
Tubo fermapiatti
Rohr-Einsatz
Tuyau
Tubo

| art. | € |
|----------|------|
| 44044-00 | 7,24 |

SQUARE FOOD STORAGE CONTAINERS
CONTENITORI QUADRATI PER LA CONSERVAZIONE
DEGLI ALIMENTI



Space-saving **SQUARE & ROUND** containers. In clear polycarbonate to identify the contents. Smooth interior finish with spoonable bottom helps prevent food waste, making clean-up easy. Printed measurements. Wide handles and drain holes for easy grip and quick drying. Stacking lugs. Tight fitting lids with hang hole. They withstand temperatures between **-40°C and 100°C**.

Contenitori **QUADRATI & ROTONDI** salvaspazio. In polycarbonato trasparente per identificare il contenuto. La finitura interna liscia con fondo con angoli arrotondati previene lo spreco di cibo e facilita la pulizia. Misurazioni stampate. Impugnatura ampia e maneggevole con fori di drenaggio per una rapida asciugatura. Alette impilabili. Coperchi ermetici con foro per appendere. Resistono a temperature comprese tra **-40°C e 100°C**.



Food container

Contenitore per alimenti
Vorratsdosen
Conteneur pour aliments
Contenedor para alimentos

| art. | cm. | lt. | € |
|----------|------------|-----|-------|
| 44628-02 | 18x18x9,6 | 1,9 | 16,78 |
| 44628-04 | 18x18x18,5 | 3,8 | 25,53 |
| 44628-06 | 22x22x18,6 | 5,7 | 33,06 |
| 44628-08 | 22x22x22,8 | 7,6 | 38,89 |



Food container

Contenitore per alimenti
Vorratsdosen
Conteneur pour aliments
Contenedor para alimentos

| art. | cm. | lt. | € |
|----------|--------------|------|-------|
| 44628-11 | 28,3x28,3x21 | 11,4 | 51,86 |
| 44628-17 | 28,3x28,3x32 | 17,0 | 76,88 |
| 44628-20 | 28,3x28,3x40 | 20,8 | 97,49 |



PE

Square lid

Coperchio quadrato
Deckel, viereckig
Couverture carré
Tapa cuadrada

| art. | cm. | lt. | col. | € |
|----------|---------------|-----------|------|-------|
| 44628-21 | 18,5x18,5x1,6 | 1,9-3,8 | ● | 7,24 |
| 44628-22 | 22,8x22,8x1,6 | 5,5-7,6 | ● | 8,94 |
| 44628-23 | 28,9x28,9x1,6 | 11,4-20,8 | ● | 13,17 |



NEW

Food container

Contentitore per alimenti
Vorratsdosen
Conteneur pour aliments
Contenedor para alimentos

| art. | Ø cm. | h. cm. | lt. | € |
|----------|-------|--------|------|-------|
| 44629-03 | 22 | 19,5 | 5,7 | 28,34 |
| 44629-04 | 22 | 27,0 | 7,8 | 32,46 |
| 44629-05 | 31 | 20,5 | 11,4 | 50,85 |
| 44629-06 | 31 | 30,0 | 17,0 | 69,75 |
| 44629-07 | 31 | 38,0 | 21,0 | 72,16 |



NEW

PE

Round lid

Coperchio rotondo
Deckel, rund
Couvercle rond
Tapa redonda

| art. | Ø cm. | col. | € |
|----------|-------|------|-------|
| 44629-R4 | 22 | ● | 4,62 |
| 44629-B7 | 31 | ● | 10,35 |



PC

Food container

Contentitore per alimenti
Nahrungsmittel-Behälter
Conteneur pour aliments
Contenedor para alimentos

| art. | cm. | lt. | € |
|----------|------------|------|--------|
| 49384-03 | 45,7x30x23 | 19,0 | 104,02 |
| 49384-04 | 45,7x66x9 | 19,0 | 107,33 |
| 49384-05 | 45,7x66x15 | 32,3 | 144,62 |
| 49384-07 | 45,7x66x38 | 81,5 | 281,60 |



PC

Drain tray

Vasca di drenaggio
Abtropf-Behälter
Conteneur perforé
Contenedor para colar

| art. | cm. | € |
|----------|------------|--------|
| 49384-11 | 45,7x66x12 | 123,92 |



PC

Lid

Coperchio
Deckel
Couvercle
Tapa

| art. | cm. | € |
|----------|---------|-------|
| 49384-14 | 45,7x30 | 40,10 |
| 49384-15 | 45,7x66 | 85,53 |



PP

Food container with lid

Contentitore per alimenti c/cop
Nahrungsmittel-Behälter mit Deckel
Conteneur pour aliments avec couvercle
Contenedor para alimentos con tapa

| art. | cm. | lt. | € |
|----------|----------|-----|-------|
| 44046-20 | 38x28x30 | 20 | 17,09 |
| 44046-40 | 58x38x26 | 40 | 26,43 |
| 44046-60 | 58x38x38 | 60 | 35,58 |



PP

Food container

Contentitore per alimenti
Nahrungsmittel-Behälter
Conteneur pour aliments
Contenedor para alimentos

| art. | mm. | lt. | € |
|----------|-------------|-----|--------|
| 49383-08 | 310x375x215 | 8 | 90,35 |
| 49383-20 | 280x595x430 | 20 | 218,19 |
| 49383-40 | 480x630x430 | 40 | 289,34 |



PP

Food storage mobile bin

Carrello per derrate alimentari
 Fahrbares Nahrungsmittelbehälter
 Chariot mobile de stockage
 Contenedor móvil para alimentos

| art. | mm. | lt. | € |
|----------|-------------|-----|--------|
| 49380-80 | 333x743x711 | 81 | 564,11 |



PP

Food storage mobile bin

Carrello per derrate alimentari
 Fahrbares Nahrungsmittelbehälter
 Chariot mobile de stockage
 Contenedor móvil para alimentos

| art. | cm. | lt. | € |
|----------|--------------|------|--------|
| 49381-01 | 74x33,5x71 | 79,0 | 911,43 |
| 49381-02 | 75x39,5x71 | 97,5 | 973,04 |
| 49381-03 | 75,5x45,5x71 | 116 | - |



HDPE

Container with handles

Contentitore con maniglie
 Behälter mit Griffen
 Conteneur avec poignées
 Contenedor con asas

| art. | Ø cm. | h. cm. | lt. | € |
|----------|-------|--------|-----|-------|
| 49372-01 | 39 | 41 | 35 | 14,57 |
| 49372-02 | 45 | 47 | 50 | 21,91 |
| 49372-03 | 49 | 57 | 75 | 30,45 |
| 49372-04 | 52 | 67 | 100 | 38,89 |



HDPE

Lid with handles

Coperchio con maniglia
 Deckel mit Griff
 Couvercle avec poignée
 Tapa con asa

| art. | Ø cm. | € |
|----------|-------|------|
| 49372-11 | 39 | 6,73 |
| 49372-12 | 45 | 8,24 |
| 49372-13 | 49 | 8,84 |
| 49372-14 | 52 | 9,55 |



PP

Trolley

Supporto mobile
 Wagen
 Chariot
 Soporte móvil

| art. | cm. | € |
|----------|----------------|--------|
| 49372-24 | 53,2x53,2x24,7 | 143,72 |

For containers Lt. 75 and 100. Four wheels, two with blocking mechanism. – Per contenitori Lt. 75 e 100. Quattro ruote di cui 2 con meccanismo di bloccaggio.



HDPE

Container without handles

Contentitore senza maniglie
 Behälter ohne Griffen
 Conteneur sans poignées
 Contenedor sin asas

| art. | Ø cm. | h. cm. | lt. | € |
|----------|-------|--------|-----|-------|
| 49372-05 | 61 | 70 | 150 | 43,62 |
| 49372-06 | 67 | 80 | 200 | 59,09 |



HDPE

Lid

Coperchio
 Deckel
 Couvercle
 Tapa

| art. | Ø cm. | € |
|----------|-------|-------|
| 49372-15 | 61 | 9,85 |
| 49372-16 | 67 | 11,26 |



SS

Sink trolley

Carrello vasca
 Obst/Gemüsewaschwagen
 Chariot à évier
 Carro-cuba lavado verduras

| art. | cm. | lt. | € |
|----------|----------|-----|----------|
| 44028-19 | 80x60x75 | 190 | 1.529,01 |

Tub with tap, brushed finish. Stamped bottom watertight, without edges. – Vasca con rubinetto, finitura spazzolata. Fondo stampato a tenuta stagna, privo di spigoli.



PE

Bread basket

Cesto pane
Brot-Korb
Corbeille à pain
Cesta pan

| art. | cm. | lt. | € |
|----------|----------|-----|-------|
| 44982-04 | 57x36x34 | 40 | 18,19 |
| 44982-06 | 66x45x35 | 60 | 21,91 |
| 44982-10 | 78x52x40 | 100 | 46,43 |



PP

Space saving box

Contenitore salvaspazio
Behälter
Réceptient
Contenedor

| art. | des. | cm. ext. | € |
|----------|---------|------------|-------|
| 44033B23 | box | 66x45x23 | 42,71 |
| 44033B38 | box | 66x45x38,5 | 68,04 |
| 44033A23 | lid/cop | 67x46x2 | 18,79 |



PP

Gastronorm basket

Cesto gastronorm
Gastronorm-Korb
Panier gastronorme
Cesta gastronorm

| art. | cm. ext. | € |
|----------|------------|-------|
| 44034-11 | 59,5x39x19 | 22,01 |

STACKABLE CONTAINERS
CONTENITORI SOVRAPPONIBILI



Stackable containers, external dimensions 600x400 mm and 400x300 mm, they perfectly fit to 800x1200 mm EUR pallets and to 1000x1200 mm. Available in different heights and versions. High density polyethylene HDPE. A thermoplastic that offers excellent impact resistance at low temperatures (from -30°C to +70°C).

Contenitori sovrapponibili con dimensioni esterne di mm 600x400 e 400x300 perfettamente pallettizzabili su pallet EUR mm 800x1200 e 1000x1200. Disponibili in diverse altezze e versioni. Polietilene alta densità HDPE. Uno dei materiali termoplastici più dotato di resistenza all'impatto con basse temperature (da -30°C a +70°C).



Container
Contenitore
Behälter
Conteneur
Contenedor

| art. | cm. | lt. | € |
|----------|----------|-----|-------|
| 44511E21 | 60x40x10 | 21 | 27,14 |
| 44511E63 | 60x40x32 | 63 | 49,65 |
| 44511E90 | 60x40x45 | 90 | 74,07 |

Solid bottom and sides. – Fondo e pareti chiuse.



Container
Contenitore
Behälter
Conteneur
Contenedor

| art. | cm. | lt. | € |
|----------|----------|-----|-------|
| 44512E12 | 60x40x7 | 12 | 19,80 |
| 44512E21 | 60x40x10 | 21 | 27,03 |

Solid bottom and perforated sides.
Fondo chiuso e pareti forate.



Container
Contenitore
Behälter
Conteneur
Contenedor

| art. | cm. | lt. | € |
|----------|----------|-----|-------|
| 44513E12 | 60x40x7 | 12 | 19,80 |
| 44513E21 | 60x40x10 | 21 | 24,52 |

Perforated bottom and sides.
Fondo e pareti forate.

**STORAGE & TRANSPORT STOCCAGGIO E TRASPORTO
STACKABLE CONTAINERS CONTENITORI SOVRAPPONIBILI**



PP

Lid
Coperchio
Deckel
Couvercle
Tapa

| art. | cm. | € |
|----------|---------|-------|
| 41763-00 | 60x40x2 | 12,26 |



PP

Lid
Coperchio
Deckel
Couvercle
Tapa

| art. | cm. | € |
|----------|---------|-------|
| 41763-30 | 40x30x2 | 13,07 |



Container
Contentitore
Behälter
Conteneur
Contenedor

| art. | cm. | lt. | € |
|----------|----------|-----|-------|
| 44521E10 | 40x30x12 | 10 | 12,56 |

Solid bottom and sides. – Fondo e pareti chiuse.



Container
Contentitore
Behälter
Conteneur
Contenedor

| art. | cm. | lt. | € |
|----------|----------|-----|-------|
| 44521-16 | 40x30x17 | 16 | 15,18 |
| 44521-21 | 40x30x22 | 21 | 17,29 |
| 44521-31 | 40x30x32 | 31 | 21,91 |

Solid bottom and sides. – Fondo e pareti chiuse.



Container
Contentitore
Behälter
Conteneur
Contenedor

| art. | cm. | lt. | € |
|----------|----------|-----|-------|
| 44511-27 | 60x40x15 | 27 | 33,57 |
| 44511-34 | 60x40x17 | 34 | 34,37 |
| 44511-38 | 60x40x20 | 38 | 36,18 |
| 44511-42 | 60x40x22 | 42 | 37,89 |
| 44511-63 | 60x40x32 | 63 | 48,54 |
| 44511-90 | 60x40x45 | 90 | 76,48 |

Solid bottom and sides. – Fondo e pareti chiuse.



Container
Contentitore
Behälter
Conteneur
Contenedor

| art. | cm. | lt. | € |
|----------|----------|-----|-------|
| 44522E10 | 40x30x12 | 10 | 18,19 |

**Solid bottom and perforated sides.
Fondo chiuso e pareti forate.**



Container
Contentitore
Behälter
Conteneur
Contenedor

| art. | cm. | lt. | € |
|----------|----------|-----|-------|
| 44522-16 | 40x30x17 | 16 | 15,18 |
| 44522-21 | 40x30x22 | 21 | 14,37 |
| 44522-31 | 40x30x32 | 31 | 16,88 |

**Solid bottom and perforated sides.
Fondo chiuso e pareti forate.**



Container
Contentitore
Behälter
Conteneur
Contenedor

| art. | cm. | lt. | € |
|----------|----------|-----|-------|
| 44512-34 | 60x40x17 | 34 | 30,35 |
| 44512-42 | 60x40x22 | 42 | 32,06 |
| 44512-63 | 60x40x32 | 63 | 38,79 |
| 44512-90 | 60x40x45 | 90 | 58,29 |

**Solid bottom and perforated sides.
Fondo chiuso e pareti forate.**



Container
Contentitore
Behälter
Conteneur
Contenedor

| art. | cm. | lt. | € |
|----------|----------|-----|-------|
| 44513-34 | 60x40x17 | 34 | 27,94 |
| 44513-38 | 60x40x20 | 38 | 29,15 |
| 44513-54 | 60x40x29 | 54 | 32,96 |
| 44513-63 | 60x40x32 | 63 | 34,17 |
| 44513-90 | 60x40x45 | 90 | 51,56 |

**Perforated bottom and sides.
Fondo e pareti forate.**





Made of expanded polypropylene (PPE), suitable for protecting food from thermal stress thanks to the insulating properties of the expanded polymer which guarantees a thermal drop compliant with the UNI EN 12571:1999 standard. Polypropylene is expanded with CO₂, without CFCs and HCFCs, and has no residual blowing agents. It has a closed cell structure which gives it excellent characteristics of energy dissipation in impacts and specific thermal resistance. Expanded Polypropylene is mainly composed of air (in relation to density it can reach 98% of air) and only 2% of pure hydrocarbon structural material, it is 100% recyclable and in infinite cycles without releasing residues into the environment or losing its chemical-physical characteristics.

Realizzati in polipropilene espanso (PPE), idonei a proteggere gli alimenti da sollecitazioni termiche grazie alle proprietà coibentanti del polimero espanso che garantisce una caduta termica conforme alla norma UNI EN 12571:1999. Il polipropilene è espanso con CO₂, senza CFC e HCFC, e non ha agenti di espansione residui. Ha una struttura a celle chiuse che gli conferisce eccellenti caratteristiche di dissipazioni di energia negli urti e di resistenza termica specifica. Il Polipropilene Espanso è composto prevalentemente da aria (in relazione alla densità può raggiungere il 98% di aria) e solo dal 2% di materiale strutturale di puro idrocarburo, è riciclabile al 100% e a cicli infiniti senza rilascio di residui nell'ambiente o perdita di caratteristiche chimico-fisiche.



NEW

Insulated GN container SMARTHEATER

Contenitore isotermico
Thermobehälter
Conteneur isotherme
Contenedor isotérmico

| art. | cm. ext. | int. | GN | lt. | € |
|----------|----------------|------------|-----|-----|--------|
| 44983-01 | 40,6x60,5x37,6 | 34x54x26,7 | 1/1 | 49 | 651,84 |

Power outlet on the back of the container. Operating temperature -40 +120°C. 220-240V. 50 Hz. 100W. (Resistance) 65°C. Capacity: 2 x GN 1/1 100 mm. or submultiples. – Presa corrente su retro contenitore. Temperatura di esercizio -40 +120°C. 220-240V. 50 Hz. 100W. (Resistenza) 65°C. Capacità: 2 x GN 1/1 100 mm. o sottomultipli.





NEW

Insulated GN container SMARTHEATER

Contentitore isothermico
Thermobehälter
Conteneur isotherme
Contenedor isotérmico

| art. | cm. ext. | int. | GN | lt. | € |
|----------|----------|----------|-----|-----|----------|
| 44983-02 | 50x65x61 | 33x54x48 | 1/1 | 83 | 1.412,43 |

Power outlet on the back of the container. Operating temperature -40 +120°C. 220-240V. 50 Hz. 165W. (Resistance) 65°C. Capacity: 2 x GN 1/1 200 mm. or submultiples. – Presa corrente su retro contenitore. Temperatura di esercizio -40 +120°C. 220-240V. 50 Hz. 165W. (Resistenza) 65°C. Capacità: 2 x GN 1/1 200 mm. o sottomultipli.



NEW

Insulated container SMARTHEATER

Contentitore isothermico
Thermobehälter
Conteneur isotherme
Contenedor isotérmico

| art. | cm. ext. | int. | lt. | € |
|----------|----------|----------|-----|----------|
| 44983-03 | 60x72x63 | 40x60x50 | 128 | 1.484,89 |

Power outlet on the back of the container. Operating temperature -40 +120°C. 220-240V. 50 Hz. 165W. (Resistance) 65°C. Capacity: 9 trays 60x40 mm. Presa corrente su retro contenitore. Temperatura di esercizio -40 +120°C. 220-240V. 50 Hz. 165W. (Resistenza) 65°C. Capacità: 9 vassoi 60x40 mm.



Insulated container UNIVERSAL PN

Contentitore isothermico
Thermobehälter
Conteneur isotherme
Contenedor isotérmico

| art. | cm. | h. | lt. | € |
|----------|-------|------|------|-------|
| 44986-17 | 61x43 | 25,0 | 33,8 | 72,86 |
| 44986-21 | 61x43 | 29,5 | 42,8 | 74,67 |
| 44986-28 | 61x43 | 36,5 | 56,7 | 78,19 |

Dim. int cm. 54,5x36,5x17 /x21,5 /x28,5.



Insulated container GN 1/2

Contentitore isothermico
Thermobehälter
Conteneur isotherme
Contenedor isotérmico

| art. | cm. | h. | lt. | € |
|----------|---------|------|------|-------|
| 44972-20 | 41,5x32 | 28,5 | 20,3 | 49,75 |
| 44972-25 | 41,5x32 | 32,0 | 21,6 | 51,56 |
| 44972-33 | 41,5x32 | 40,0 | 31,2 | 56,88 |

Dim. int cm. 35x27x21,5 /x25 /x33.



Insulated container GN 1/1

Contentitore isothermico
Thermobehälter
Conteneur isotherme
Contenedor isotérmico

| art. | cm. | h. | lt. | € |
|----------|-------|----|------|-------|
| 44970-10 | 60x40 | 17 | 20,2 | 55,07 |
| 44970-15 | 60x40 | 23 | 31,2 | 56,88 |

Dim. int cm. 54x34x11 /x17.





Insulated container GN 1/1

Contentitore isotermico
Thermobehälter
Conteneur isotherme
Contenedor isotérmico

| art. | cm. | h. | lt. | € |
|----------|-------|----|------|-------|
| 44970-20 | 60x40 | 27 | 38,6 | 64,02 |
| 44970-34 | 60x40 | 34 | 52,3 | 65,83 |

Dim. int cm. 54x340x21 /x28.



Insulated container PLUS GN 1/1

Contentitore isotermico
Thermobehälter
Conteneur isotherme
Contenedor isotérmico

| art. | cm. | h. | lt. | € |
|----------|---------|----|------|-------|
| 44978-20 | 68x44,5 | 30 | 45,6 | 87,13 |

Dim. int cm. 56x37x22.



Insulated pastry container

Contentitore isotermico pasticceria
Konditorei-Thermobehälter
Conteneur isotherme à pâtisserie
Contenedor isotérmico para pastelería

| art. | cm. | h. | lt. | € |
|----------|-----------|----|------|-------|
| 44974-21 | 68,5x48,5 | 27 | 55,8 | 83,52 |
| 44974-27 | 68,5x48,5 | 33 | 71,7 | 87,13 |
| 44974-31 | 68,5x48,5 | 37 | 82,3 | 92,46 |

Dim. int cm. 62,5x42,5x21 /x26 /x31.



Insulated container HANDTOP

Contentitore isotermico
Thermobehälter
Conteneur isotherme
Contenedor isotérmico

| art. | cm. | h. | lt. | € |
|----------|---------|------|-----|-------|
| 44961-06 | 71,5x40 | 31,5 | 45 | 94,27 |

Dim. int cm. 55x34x24. Incorporated ergonomic handles. For GN 1/1. – Maniglie ergonomiche incorporate. Trasporta GN 1/1.



Insulated container TROLLEYBOX

Contentitore isotermico
Thermobehälter
Conteneur isotherme
Contenedor isotérmico

| art. | cm. | h. | lt. | € |
|----------|-------|----|-----|--------|
| 44961-04 | 42x42 | 60 | 60 | 245,32 |

Dim. int cm. 36x36x46.



Insulated container BOXSHOP

Contentitore isotermico
Thermobehälter
Conteneur isotherme
Contenedor isotérmico

| art. | cm. | h. | lt. | € |
|----------|---------|----|------|-------|
| 44961-02 | 41,5x32 | 32 | 21,6 | 78,19 |

Dim. int cm. 35x27x25



Insulated container PIZZABOX

Contentitore isotermico
Thermobehälter
Conteneur isotherme
Contenedor isotérmico

| art. | cm. | h. | lt. | € |
|----------|-------|------|-----|-------|
| 44961-03 | 42x42 | 34,5 | 36 | 95,98 |

Dim. int cm. 36x36x28. With steam release system. – Con sistema di rilascio del vapore.



Insulated container PORTER GN 1/1

Contentitore isotermico
Thermobehälter
Conteneur isotherme
Contenedor isotérmico

| art. | cm. | h. | lt. | € |
|----------|-------|----|-----|--------|
| 44987-11 | 65x50 | 61 | 83 | 323,61 |

Dim. int cm. 54x33x48. For GN 1/1. 12 slides. Per GN 1/1. 12 guide.



Insulated container PORTER MAXI

Contentitore isotermico
Thermobehälter
Conteneur isotherme
Contenedor isotérmico

| art. | cm. | h. | lt. | € |
|----------|-------|----|-----|--------|
| 44987-60 | 72x60 | 63 | 128 | 387,63 |

Dim. int cm. 60x40x50. For pastry trays 60x40. 9 slides. – Per teglie 60x40. 9 guide.



Insulated container GN CRYSTAL

Contentitore isotermico
Thermobehälter
Conteneur isotherme
Contenedor isotérmico

| art. | cm. | h. | lt. | € |
|----------|-------|----|------|--------|
| 44968-00 | 60x40 | 30 | 45,4 | 161,81 |

Dim. int cm. 54x34x24. Inside crystallized and therefore perfectly smooth, rigid and waterproof.
Interno cristallizzato perfettamente liscio, rigido e impermeabile.



Dolly, aluminum/ABS

Carrello, alluminio/ABS
Fahrgestell, Aluminium/ABS
Chariot, aluminium/ABS
Carro, aluminio/ABS

| art. | cm. | for/per | € |
|----------|-----------|-------------|--------|
| 44975C50 | 58,5x58,5 | 44975-50 | 228,74 |
| 44987C11 | 68x52 | 44987-11 | 228,74 |
| 44987C60 | 75x61 | 44987-60 | 239,29 |
| 44987C62 | 62x42 | 44968&44970 | 219,79 |



Eutectic pad

Accumulatore di freddo
Kühlakku
Cartouche eutectique
Placa eutética

| art. | cm. | GN | € |
|----------|-------------|-----|--------|
| 44979-04 | 32,5x26,5x3 | 1/2 | 48,14 |
| 44979-05 | 53x32,5x3 | 1/1 | 81,71 |
| 44979-06 | 60x40x3 | - | 110,15 |

Temp. 0/-21°C.



Heat accumulator

Accumulatore di caldo
Wärmespeicher
Accumulateur de chaleur
Acumulador de calor

| art. | cm. | GN | € |
|----------|-----------|-----|--------|
| 44979-02 | 53x32,5x3 | 1/1 | 195,57 |

Temp. 0/+65°C.



Insulated box

Box isotermico
Thermobehälter
Conteneur isotherme
Contenedor individual isotérmico

| art. | cm. | h. | € |
|----------|-------|----|-------|
| 44976-04 | 44x38 | 12 | 56,88 |

3 sections for dishes ø 12 h 6 cm or 16x16 cm.
3 vani per piatti ø 12 h 6 cm o 16x16 cm.



Insulated box DOMUS

Box isotermico
Thermobehälter
Conteneur isotherme
Contenedor individual isotérmico

| art. | cm. | h. | € |
|----------|-----------|------|-------|
| 44976-02 | 42,5x26,5 | 16,5 | 55,07 |

2 sections for dishes 18x18 cm.
2 vani per piatti 18x18 cm.



Insulated box MONOKING

Box isotermico
Thermobehälter
Conteneur isotherme
Contenedor individual isotérmico

| art. | cm. | h. | € |
|----------|---------|----|-------|
| 44976-01 | 48,5x35 | 16 | 56,88 |

2 insulated sections for dishes size 18x18 cm.
2 vani coibentati per piatti 18x18 cm.



Insulated box THERMOKING

Box isotermico
Thermobehälter
Conteneur isotherme
Contenedor individual isotérmico

| art. | cm. | h. | € |
|----------|-------|------|-------|
| 44976-03 | 47x37 | 18,5 | 76,48 |

Release latch lid. Usefull height 11,5 cm.
Coperchio a incastro. Altezza utile 11,5 cm.



Food container

Pietanziera
Speisenbehälter
Porte-manger
Contenedor comida

| art. | Ø cm. | h. cm. | € |
|----------|-------|--------|-------|
| 44977-12 | 12 | 6 | 28,44 |

SS



MODULAR SYSTEM BASE=LID EXTENSIBLE HEIGHT
SISTEMA MODULARE BASE-COPERCHIO ALTEZZA ESTENSIBILE

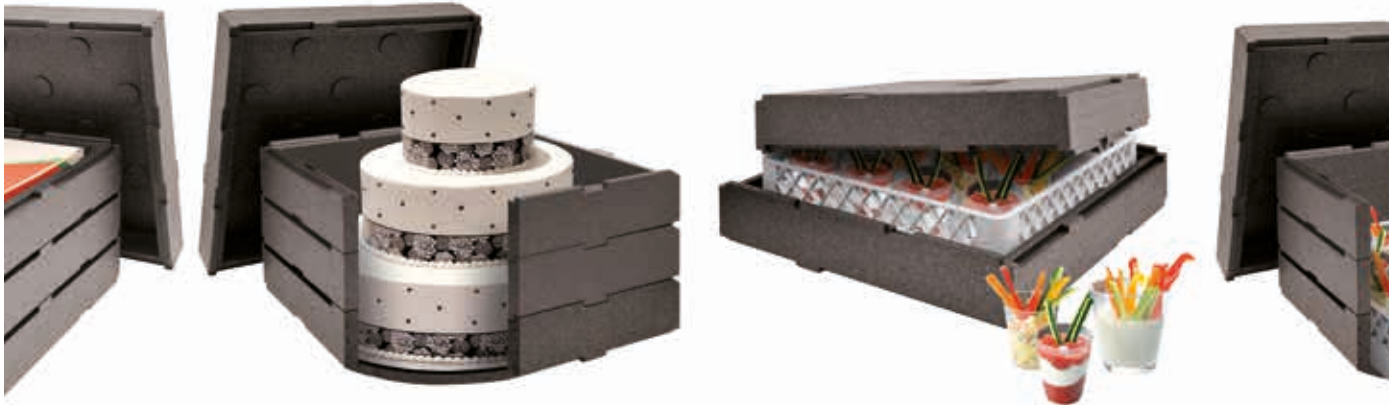

Modular system, the base and lid are the same element and due to the extender insert it is possible to increase capacity. Equipped with rotation system that allows steam to escape.

Sistema modulare, base e coperchio sono lo stesso elemento e grazie all'inserto estensore è possibile aumentare la capacità. Provvisto di sistema rotabile, per la fuoriuscita del vapore.



Base and lid

Base e coperchio
Basis und Abdeckung
Base et couvercle
Base y tapa

| art. | cm. ext. | int. | € |
|----------|-----------|-----------|-------|
| 44975-50 | 57x57x9,5 | 51x51x6,3 | 49,75 |



Extender

Estensore
Aufsatz
Réhausse
Extensión

| art. | cm. ext. | int. | € |
|----------|-----------|-----------|-------|
| 44975H50 | 57x57x9,5 | 51x51x7,5 | 48,04 |



NEW
PE

Insulated container GN 1/1
Contentitore isothermico GN 1/1
Thermobehälter GN 1/1
Conteneur isotherme GN 1/1
Contenedor isotérmico GN 1/1

| art. | cm. ext. | int. | Kg. | € |
|----------|----------|----------|-----|----------|
| 44937-01 | 68x46x74 | 53x35x50 | 21 | 1.150,32 |

LLDPE and polyurethane. Keeps food hot or cold up to 6+ hours. Stackable. - LLDPE e poliuretano. Mantiene il cibo caldo o freddo fino a 6 ore. Impilabile.



NEW
PE

Dolly
Carrello
Fahrgestell
Chariot
Carro

| art. | cm. | Kg. | € |
|----------|----------|------|--------|
| 44937-02 | 68x48x25 | 6,58 | 555,26 |

LLDPE. Omnidirectional casters.
LLDPE. Ruote omnidirezionali.





Insulated container GN 1/1
 Contenitore isothermico GN 1/1
 Thermobehälter GN 1/1
 Conteneur isotherme GN 1/1
 Contenedor isotérmico GN 1/1

| art. | cm. | lt. | € |
|----------|----------|------|--------|
| 44932-15 | 61x41x25 | 24,6 | 452,15 |
| 44932-20 | 61x41x30 | 31,1 | 482,30 |

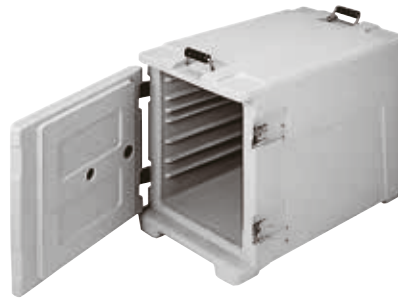

Insulated container GN 1/1
 Contenitore isothermico GN 1/1
 Thermobehälter GN 1/1
 Conteneur isotherme GN 1/1
 Contenedor isotérmico GN 1/1

| art. | cm. | lt. | € |
|----------|----------|-----|--------|
| 44934-30 | 44x64x48 | 63 | 616,67 |



Insulated beverage dispenser
 Distributore di bevande isothermico
 Isolierte Getränkebehälter
 Conteneur isotherme avec robinet
 Contenedor isotérmico con grifo

| art. | cm. | lt. | € |
|----------|----------|-----|--------|
| 44930-10 | 24x43x43 | 10 | 401,90 |
| 44930-20 | 30x46x46 | 20 | 443,31 |



PE

Ice cart
 Carrello porta ghiaccio
 Eiswaagen
 Chariot à glace
 Carro hielo

| art. | cm. | € |
|----------|------------|----------|
| 44936-01 | 71x56,5x73 | 2.292,61 |

Load/Carico: 57 kg.



Ice scoop with holder
 Pala ghiaccio con supporto
 Eisschaufel mit Träger
 Pelle à glace avec support
 Librador hielo con soporte

| art. | cm. | lt. | € |
|----------|--------------|-----|--------|
| 44936-22 | 61,5x47x25,4 | 2,5 | 250,85 |

BPA Free.



Ice bucket
 Secchio ghiaccio
 Eiseimer
 Seau à glace
 Cubo hielo

| art. | cm. | lt. | € |
|----------|----------|------|--------|
| 44936-25 | 34x30x46 | 22,7 | 231,65 |

BPA Free.

JACKSTACK

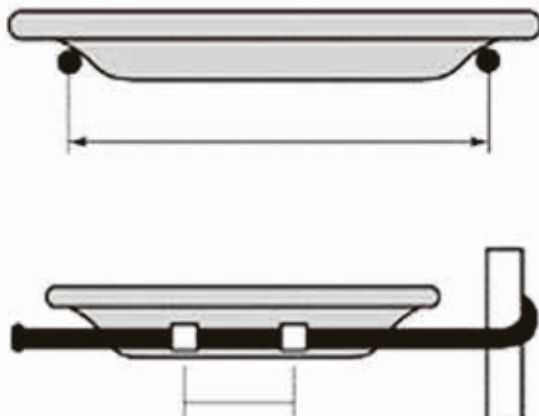

Welded steel construction. Black electrostatic powder coating. Quick set assembly in minutes. Quick-change to any plate size (max ø cm 30, kg 3 each). Length of plate support 17 cm, spacing 5 cm.

Struttura in acciaio saldato. Rivestimento nero elettrostatico. Assemblaggio veloce. Adattabile ad ogni misura di piatto (ø max cm 30, kg 3). Lunghezza bracci 17 cm, distanza 5 cm.





Mobile plate rack

Carrello porta piatti
Fahrbares Tellergestell
Chariot porte-assiettes mobile
Carrito para almacenaje de platos

| art. | cm. | € |
|----------|-----------|----------|
| 44830-99 | 60x60X179 | 2.241,45 |

For pcs/Per pz 104

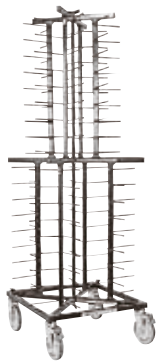

Mobile plate rack

Carrello porta piatti
Fahrbares Tellergestell
Chariot porte-assiettes mobile
Carrito para almacenaje de platos

| art. | cm. | € |
|----------|-----------|----------|
| 44830-72 | 60x60X180 | 2.145,57 |

For pcs/Per pz 72



Mobile plate rack

Carrello porta piatti
Fahrbares Tellergestell
Chariot porte-assiettes mobile
Carrito para almacenaje de platos

| art. | cm. | € |
|----------|-----------|----------|
| 44830-52 | 60x60x103 | 1.558,35 |

For pcs/Per pz 52

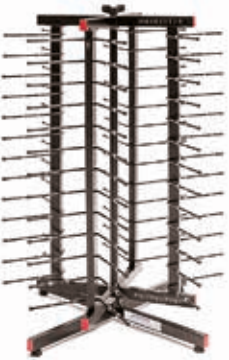

Swivelling table top rack

Porta piatti rotante
Drehbares Tischgestell
Porte-assiettes de table pivotant
Soporte para almacenaje de platos

| art. | cm. | € |
|----------|----------|----------|
| 44831-52 | 48x48x89 | 1.186,60 |

For pcs/Per pz 52



Zippered plastic cover

Copertura in plastica
Plastik Schutzhülle
Housse en plastique
Cubre carrito, plástico

| art. | for/per | € |
|----------|-------------------|--------|
| 44832-99 | 44830-72/44830-99 | 227,83 |



Thermo cover

Copertura termica
Thermo-Hülle
Thermo-housse
Cubre carrito, térmico

| art. | for/per | € |
|----------|-------------------|----------|
| 44833-99 | 44830-72/44830-99 | 1.115,55 |



Thermic hot box

Box termico
Speisen-Kaste
Caisson thermique
Cajón térmico

| art. | cm. | W | € |
|----------|--------------|-----|----------|
| 44094-00 | 38x40,5x51,2 | 500 | 1.038,67 |

Stainless steel box with double insulated wall. Analogic thermostat 30-90°C.
– Box in acciaio inox a doppia parete coibentata. Termostato analogico 30-90°C.



Refrigerated box

Box refrigerato
Speisen-Kaste
Caisson réfrigéré
Cajón refrigerado

| art. | cm. | € |
|----------|------------|--------|
| 44094R00 | 38x40,5x51 | 956,36 |

Stainless steel box with double insulated wall with chilling pack -32°C. – Box in acciaio inox a doppia parete coibentata. Refrigerazione a mezzo di una piastra eutettica -32°C.



Table with hot box

Tavolino con box termico
Tisch mit Hot Box
Table avec hot box
Carrito con hot box

| art. | Ø cm. | h. cm. | W | € |
|----------|---------|--------|-----|----------|
| 44094-04 | 90/54,6 | 78,6 | 500 | 2.352,50 |

Table with fold down flaps. With capsizable top for stacking when not in use.
Tavolo con flaps pieghevoli. Ribaltabile e impilabile quando non in uso.

Fast food tray

Vassoio fast food
Serviertablett, Fast Food
Plateau fast food
Bandeja fast food

| art. | cm. | € |
|----------|-----------|------|
| 41860-36 | 27x36,5 | 4,32 |
| 41860-43 | 30,7x43,5 | 6,03 |
| 41860-47 | 35,5x47 | 6,63 |



Fast food tray

Vassoio fast food
Serviertablett, Fast Food
Plateau fast food
Bandeja fast food

| art. | cm. | € |
|----------|---------|------|
| 41861-44 | 30,7x44 | 6,73 |



Gastronorm tray

Vassoio Gastronorm
Serviertablett, Gastronorm
Plateau Gastronorm
Bandeja Gastronorm

| art. | cm. | col. | € |
|----------|-------------|------|-------|
| 41862B11 | 53x32,5x1,6 | ● | 12,86 |
| 41862C11 | 53x32,5x1,6 | ● | 12,86 |
| 41862G11 | 53x32,5x1,6 | ● | 12,86 |



Euronorm tray

Vassoio Euronorm
Serviertablett, Euronorm
Plateau Euronorm
Bandeja Euronorm

| art. | cm. | col. | € |
|----------|-----------|------|-------|
| 41862B53 | 53x37x1,6 | ● | 13,37 |
| 41862C53 | 53x37x1,6 | ● | 13,37 |
| 41862G53 | 53x37x1,6 | ● | 13,37 |



Universal tray collector trolley

Carrello ritiro vassoi universale
Tablettabräumwagen Universal
Chariot débarrassage plateaux universel
Carro porta bandeja universal

| art. | cm. | € |
|----------|-----------|--------|
| 44803-10 | 47x55x153 | 559,58 |
| 44803-20 | 88x55x153 | 849,63 |

12 cm between shelves. 4 swivel wheels 100 mm. Chrome-plated steel thread supports 6 mm.
Distanza fra piani 12 cm. 4 ruote girevoli 100 mm. Supporti in filetto acciaio cromato 6 mm.



Universal tray collector trolley

Carrello ritiro vassoi universale
Tablettwagen Universal
Chariot débarrassage plateaux universel
Carro porta bandeja universal

| art. | cm. | € |
|----------|------------|----------|
| 44803-30 | 129x55x153 | 1.061,68 |

They can hold trays in different sizes (width ranging from 300 to 370 mm) including Euronorm and Gastronorm. – Possono accogliere vassoi di varia misura (larghezza tra 300 e 370 mm) inclusi Euronorm e Gastronorm.



Disposable covers, 200 pcs

Coperture monouso, 200 pezzi
Einweg-Schutzhüllen, 200 Stk.
Housses usage unique, 200 pcs
Cubrecajitos desechables, 200 pz

| art. | for/per | h. cm. | € |
|----------|---------|--------|--------|
| 42512-91 | GN 1/1 | 180 | 273,16 |
| 42512-92 | GN 2/1 | 180 | 347,23 |
| | 60x40 | 180 | |





SS

Roll holder
Porta rotolo
Rollenhalter
Dérouleur mural
Portarollos

| art. | cm. | € |
|----------|----------|--------|
| 42512-90 | 90x23x19 | 275,07 |



SS

Utility rack GN 2/1
Carrello GN 2/1
2/1 GN-Behälterwagen
Chariot GN 2/1
Carro GN 2/1

| art. | cm. | € |
|----------|-------------|----------|
| 44807-28 | 60x70x153,5 | 1.521,17 |

Welded structure, 28 rails, 4 wheels, 2 with brakes. – Struttura saldata, 28 guide, 4 ruote girevoli di cui 2 con freno.



SS

Utility rack GN 2/1
Carrello GN 2/1
2/1 GN-Behälterwagen
Chariot GN 2/1
Carro GN 2/1

| art. | cm. | € |
|----------|-----------|--------|
| 44807-36 | 73x62x171 | 865,10 |

To be assembled, 18 rails, accomodates GN pans height 65 mm. Load max 300 kg. – Fornito smontato, 18 guide, accoglie GN di h. 65 mm. Carico max 300 kg.



SS

Utility rack GN 1/1
Carrello GN 1/1
1/1 GN-Behälterwagen
Chariot GN 1/1
Carro GN 1/1

| art. | cm. | € |
|----------|-----------|--------|
| 44807-18 | 38x62x164 | 641,89 |

To be assembled, 18 rails, accomodates GN pans height 65 mm. Load max 150 kg. – Fornito smontato, 18 guide, accoglie GN di h. 65 mm. Carico max 150 kg.



SS

Utility rack GN 1/1
Carrello GN 1/1
1/1 GN-Behälterwagen
Chariot GN 1/1
Carro GN 1/1

| art. | cm. | € |
|----------|------------|--------|
| 44801-09 | 38x62x94,5 | 449,84 |

To be assembled, 9 rails, accomodates GN pans height 65 mm. Load max 75 kg. – Fornito smontato, 9 guide, accoglie GN di h. 65 mm. Carico max 75 kg.



SS

Baking sheet trolley
Carrello porta teglie
Backbleche-Wagen
Chariot pour plaques
Carro porta placas

| art. | cm. | € |
|----------|----------|--------|
| 44826-00 | 52x72x85 | 691,84 |

Pitch 7,5 cm. For 60x40 cm trays. S/steel top. Swivel castors ø 9,5 cm, 2 with brakes. – Passo 7,5 cm. Per teglie cm 60x40. Piano superiore inox. Ruote piroettanti ø cm 9,5 di cui 2 con freno.



SS

Serving trolley
Carrello di servizio
Mehrzweckwagen
Chariot de service
Carrito para desocupar

| art. | cm. | € |
|----------|----------|--------|
| 44819-02 | 91x59x93 | 269,94 |

To be assembled, 4 swivel castors, 2 with brakes. Load max 80 kg. – Fornito smontato, 4 ruote girevoli di cui 2 con freno. Carico max 80 kg.



SS

Serving trolley
Carrello di servizio
Mehrzweckwagen
Chariot de service
Carrito para desocupar

| art. | cm. | € |
|----------|----------|--------|
| 44819-03 | 91x59x93 | 310,55 |

To be assembled, 4 swivel castors, 2 with brakes. Load max 120 kg. – Fornito smontato, 4 ruote girevoli di cui 2 con freno. Carico max 120 kg.



SS

Serving trolley
Carrello di servizio
Mehrzweckwagen
Chariot de service
Carrito para desocupar

| art. | cm. | € |
|----------|-------------|--------|
| 44820-80 | 80x50x93,5 | 416,77 |
| 44820-99 | 100x50x93,5 | 470,04 |

To be assembled, 4 swivel castors, 2 with brakes. Max load per shelf kg 30. – Fornito smontato, 4 ruote girevoli di cui 2 con freno. Portata max. per ripiano kg 30.



SS

Serving trolley

Carrello di servizio
Mehrzweckwagen
Chariot de service
Carrito para desocupar

| art. | cm. | € |
|----------|-------------|--------|
| 44822-80 | 80x50x93,5 | 543,00 |
| 44822-99 | 100x50x93,5 | 581,19 |

To be assembled, 4 swivel castors, 2 with brakes. Max load per shelf kg 30. – Fornito smontato, 4 ruote girevoli di cui 2 con freno. Portata max. per ripiano kg 30.



PP

Serving trolley

Carrello di servizio
Mehrzweckwagen
Chariot de service
Carrito para desocupar

| art. | cm. | € |
|----------|----------|--------|
| 44030-03 | 42x71x90 | 247,93 |



PP

Bins and containers

Cesti e contenitori
Kasten und Körbe
Réipients et containers
Cubos y contenedores

| art. | cm. | € |
|----------|------------|-------|
| 44031-04 | 52x39x12,7 | 13,87 |
| 44031-05 | 52x39x17,7 | 14,97 |



PE

Container

Contentitore
Kaste
Réipient
Contenedor

| art. | cm. | € |
|----------|--------------|-------|
| 44031-01 | 33,7x23x56 | 68,14 |
| 44031-02 | 33,7x23x18,7 | 42,01 |



PP

Serving trolley

Carrello di servizio
Mehrzweckwagen
Chariot de service
Carrito para desocupar

| art. | cm. | € |
|----------|----------|--------|
| 49995-04 | 97x51x99 | 786,71 |

Load max 135 kg (45 kg per shelf).
Carico max 135 kg (45 kg per ripiano).



SS

Minibar restocking cart

Carrello rifornimento frigobar
Wagen für Minibar-Versorgung
Chariot mini-bar
Carro servizio minibar

| art. | cm. | € |
|----------|-----------|--------|
| 44095-30 | 73x47x102 | 862,49 |

3 PVC boxes with anti-tip cage for 40 bottles ø 6,5 cm max. Castor wheels ø 12,5 cm, 2 with brakes. – Con 3 cassette in PVC, dotate di gabbia antiribaltamento per 40 bottiglie ø cm 6,5 max. Ruote piroettanti ø cm 12,5 di cui 2 con freno.



Minibar restocking cart

Carrello rifornimento frigobar
Wagen für Minibar-Versorgung
Chariot mini-bar
Carro servizio minibar

| art. | cm. | € |
|----------|------------|----------|
| 44095-32 | 100x62x119 | 1.783,27 |

Side handle. Key lock. 2 fixed and 2 swivel casters ø 16 cm 2 with brakes. – Maniglia laterale di spinta. Chiusura con chiave. Ruote ø cm 16, di cui due fisse e due piroettanti con freno.



SS

Utility rack GN 2/1

Carrello GN 2/1
2/1 GN-Behälterwagen
Chariot GN 2/1
Carro GN 2/1

| art. | cm. | € |
|----------|------------|--------|
| 44801-18 | 73x62x94,5 | 555,56 |

To be assembled, 9 rails, accomodates GN pans height 65 mm. Load max 150 kg. – Fornito smontato, 9 guide, accoglie GN di h. 65 mm. Carico max 150 kg.



SS

Baking sheet trolley

Carrello porta teglie
Backbleche-Wagen
Chariot pour plaques
Carro porta placas

| art. | cm. | € |
|----------|-----------|--------|
| 44826-20 | 69x49x187 | 778,67 |

20 rails for baking sheets cm 60x40, height clearance 8 cm. Load max 100 kg. – 20 guide per teglie cm 60x40, distanza guide 8 cm. Carico max 100 kg.



Baking sheet trolley, galvanized steel

Carrello porta teglie, zincato
Backbleche-Wagen, verzinkt
Chariot pour plaques, galvanisé
Carro porta placas, galvanizado

| art. | cm. | € |
|----------|-----------|--------|
| 44825-20 | 51x50x170 | 448,93 |

20 rails, height clearance 8 cm. Load max. 80 kg. – 20 guide, distanza guide 8 cm. Carico max 80 kg.

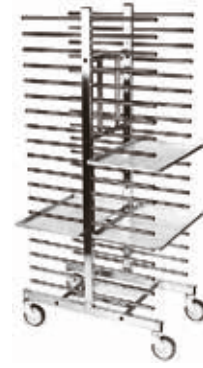

Baking sheet trolley, galvanized steel

Carrello porta teglie, zincato
Backbleche-Wagen, verzinkt
Chariot pour plaques, galvanisé
Carro porta placas, galvanizado

| art. | cm. | € |
|----------|-----------|--------|
| 44825-40 | 51x75x170 | 558,88 |

40 rails, height clearance 8 cm. Load max 160 kg. – 40 guide, distanza guide 8 cm. Carico max 160 kg.



SS

Dolly for cases

Carrello porta cassette
Plattformwagen
Chariot à caisses
Carretilla de transporte

| art. | cm. | € |
|----------|----------|--------|
| 44026-60 | 65x45x12 | 156,88 |

Load max 50 kg. – Carico max 50 kg.



PE

Platform cart

Carrello trasporto materiali
Plattformwagen
Chariot de transport
Plataforma móvil

| art. | cm. | € |
|----------|--------------|--------|
| 49378-00 | 82,6x52x98,7 | 488,63 |

Three position handle ensures optimum handling whatever the load. Non slip deck, 2 swivel and 2 rigid castors. Load 181 kg. – Maniglia regolabile in 3 posizioni. Superficie antiscivolo. 2 ruote fisse, 2 pivotanti. Carico 181 kg.



PP

Trolley, convertible

Carrello convertibile
Plattformwagen, umwandelbar
Chariot convertible
Carretilla convertible

| art. | cm. | € |
|----------|------------|----------|
| 49379-00 | 56x53x43,5 | 1.142,58 |

Four non-marking casters (two rear locking), 2 swivel and 2 rigid. – Ruote antitraccia di cui 2 fisse e 2 girevoli, ruote posteriori bloccabili.



CLEANING & SAFETY PULIZIA & SICUREZZA





PP

Changing table

Fasciatoio da parete
Windeln-Tisch
Table à langer
Mesa cambia-pañales

| art. | cm. | € |
|----------|------------|--------|
| 49336-00 | 91x71x49,6 | 956,26 |
| 49336-02 | 60x88x48 | 956,26 |

Rated for continuous use up to 23 kg. – Portata max in uso 23 kg.



PP

Sturdy chair

Seggiolone
Kinderstuhl
Chaise d'enfant
Silla niños

| art. | cm. | € |
|----------|------------|--------|
| 49337-00 | 60x60x75,5 | 650,24 |
| 49337-01 | 29x47x8,3 | 124,42 |

For children up to 3 years old or 18 kg weight. With Microban antimicrobial protection. – Adatto a bambini fino a 3 anni o 18 kg di peso. Con protezione antibatterica in Microban.



W

Sturdy chair

Seggiolone
Kinderstuhl
Chaise d'enfant
Silla niños

| art. | cm. | col. | € |
|----------|----------|------|--------|
| 49335-01 | 50x50x75 | ● | 201,30 |
| 49335-02 | 50x50x75 | ● | - |

Suitable for children from 6 months to 3 years. Max 20 kg. Solid and sturdy, built with rubber tree wood, respecting the environment. Wide base for greater stability. Easy to assemble. Stackable to save space. Supplied with seat belts and safety buckle. – Adatto ai bambini da 6 mesi a 3 anni. Fino a 20 kg. Solido e robusto, costruito con legno di albero della gomma, in rispetto dell'ambiente. Base larga per una maggiore stabilità. Facile da montare. Impilabile per risparmiare spazio. Fornito con cinture e fibbia di sicurezza.



Trolley Quick Cart

Carrello Quick Cart
Quick Cart-Wagen
Chariot Quick Cart
Carretilla Quick Cart

| art. | cm. | Kg. | cap. m3 | € |
|----------|----------|-----|---------|--------|
| 44178-01 | 42x36x43 | 6,5 | 0,05 | - |
| 44178-02 | 42x36x53 | 7,0 | 0,06 | 947,51 |

Versatile compartments allow for multiple configurations and uses. Removable caddy. Adjustable dividers. Teflon fabric protector, repels water, oil and stains. Reinforced rubberised kick plate. – Scomparti versatili consentono molteplici configurazioni e usi. Cestello estraibile. Divisori removibili. Rivestimento in Teflon, respinge acqua, olio e macchie. Scocca rinforzata in gomma.



PP

Service trolley

Carrello di servizio
Servicewagen
Chariot de service
Carro de habitaciones

| art. | cm. | lt. | Kg. | € |
|----------|------------|---------|------|----------|
| 44174-24 | 177x58x107 | 120+120 | 26,4 | 1.113,94 |

Wheels ø 125 mm, 2 bag holders + 2 bags It 120. Made in PP copolymer. – Ruote ø 125 mm, 2 portasacco pieghevoli + 2 sacco It 120. Prodotto in PP copolimero.



PP

Service trolley

Carrello di servizio
Servicewagen
Chariot de service
Carro de habitaciones

| art. | cm. | lt. | Kg. | € |
|----------|------------|-----|-----|----------|
| 44177-12 | 104x56x130 | 150 | 26 | 1.285,50 |

Frame in tubular steel rilsan coated. Wheels ø 125 mm. 3 wooden shelves 50x46 cm. Bag holder + canvas bag polyester 55x55x94 cm. – Montanti in tubolare inox verniciato rilsan. Ruote ø 125 mm. 3 ripiani legno 50x46 cm. Portasacco+sacco in tela poliestere 55x55x94 cm.



PP

Housekeeping cart for linen collection

Carrello portabiancheria
Hotelwäschewagen
Chariot d'étage à linge
Carro de recogida de ropa

| art. | cm. | lt. | Kg. | € |
|----------|------------|-----|------|--------|
| 44176-30 | 105x55x105 | 300 | 12,5 | 561,80 |

Frame in tubulast steel rilsan coated. Wheels ø 125 mm. Nylon bag. – Montanti in tubolare inox verniciato rilsan. Ruote ø 125 mm. Sacco in nylon plastificato.



Housekeeping cart for linen collection

Carrello portabiancheria
Hotelwäschewagen
Chariot d'étage à linge
Carro de recogida de ropa

| art. | cm. | lt. | Kg. | € |
|----------|-----------|-----|------|--------|
| 44175-15 | 62x60x103 | 150 | 6,39 | 262,00 |

Capacious canvas bag laminated washable at 30°C. Folding frame. Swivel casters ø 80 mm. – Capiente sacco in tela plasticata lavabile a 30°C. Telaio pieghevole. Ruote piroettanti ø 80 mm.



Cleaning system, Pulse

Sistema di pulizia, kit Pulse
Reinigungssystem Pulse
Système de nettoyage Pulse
Sistema de limpieza Pulse

| art. | cm. | € |
|----------|--------------|--------|
| 44151-00 | 12,4x9,5x142 | 291,85 |

Aluminum frame 40 cm and 2 microfibre mops. On-board reservoir 700 ml that allows to clean up to 80 sqm. – Telaio in alluminio con velcro da 40 cm, 2 mop in microfibra. Dotato di deposito integrato da 700 ml che permette di pulire fino a 80 mq.



Microfibre mops

Mop in microfibra
Microfiber-Mops
Franges en microfibra
Fregadoras de microfibra

| art. | cm. | des. | U. Pack | € |
|----------|-------|-------------|---------|-------|
| 44151-AA | 40x14 | Wet | 10 | 24,82 |
| 44151-AB | 40x14 | High absorb | 10 | 45,02 |
| 44151-AC | 40x14 | Scrubber | 10 | 31,66 |

Wet use, high absorbency, for 80 sqm. Launderable up to 500 times (200 with bleach) at high water temperature. – Uso umido ad elevata assorbenza 80 mq. Ciclo di vita: 500 lavaggi (200 con candeggina) ad elevate temperature.



Dust beater V sweeper

Scopa a forbice
Doppel-Wischmop
Balai double mop
Escoba doble

| art. | h. cm. | € |
|----------|--------|--------|
| 44160-03 | 135 | 134,77 |

Opening angle 140° about. Cotton mops length 100 cm. – Apertura 140° circa. Frange in cotone 100 cm.



Mechanical sweeper

Aspirapolvere meccanico
Kehrer mit mechanischem Antrieb
Balai mécanique
Escoba mecánica

| art. | cm. | lt. | € |
|----------|-------------|-----|--------|
| 44150-19 | 28,5x25x102 | 0,6 | 155,98 |

ABS and galvanised steel construction. Ideal for hard floors and low pile carpets. Sweeping path 19 cm. – ABS e acciaio galvanizzato. Ideale sia per tappeti/moquette a pelo corto che per pavimenti. Battuta 19 cm.



PP

Broom + dust pan

Scopa + alza immondizia
Kehrset mit Stiel und Schmutzcontainer
Balai + pelle
Escoba + recogedor

| art. | cm. | € |
|----------|--------------|--------|
| 44149-03 | 28,6x13x32,5 | 154,67 |

Self opening and closing lid. Broom hanger bracket. – Porta immondizia con coperchio. Staffa di supporto per scopa.



PP

Dustpan

Pattumiera
Müllschaufel
Pelle à poussière
Pala

| art. | cm. | € |
|----------|------------|-------|
| 44170-00 | 29x28x87,5 | 30,85 |

Shock-proof plastic material, equipped with a rubber blade that adheres perfectly to the floor. Aluminium handle. – Materiale plastico antiurto, dotata di una lamina di rifinitura in gomma che aderisce perfettamente al pavimento.





PP

Broom, aluminum rod

Scopa, manico alluminio
Besen mit Alustiel
Balai, manche alu
Escoba, mango alumimio

| art. | h. cm. | € |
|----------|--------|-------|
| 44170-01 | 80 | 11,66 |

To use in combination with the handy dustpan thanks to its ergonomic grip with handle holder.
Da utilizzarsi abbinata alla pattumiera, a cui può essere agganciata tramite l'attacco portamanico.



Wet mop handles

Manico per mop
Nassmopp-Stiele
Supports pour franges
Mangos para fregonas

| art. | cm. | col. | € |
|----------|-------|------|-------|
| 44141-01 | 152,4 | ● | 59,30 |
| 44141-03 | 152,4 | ● | 59,30 |

Polypropylene/Glass fiber.
Polipropilene/fibra di vetro.



Cotton-end string mop

Mop a strisce in cotone
Spaghetti-Mop mit Baumwollend
Frangè à ficelles en coton
Mopa de algodón

| art. | gr. | € |
|----------|-----|-------|
| 44142-40 | 400 | 16,68 |



Cotton mop rod, screw fitting

Manico per mop, attacco filettato
Mop-Stange mit Schraubanschluss
Manche pour mop avec attache à vis
Mango para fregadora, conexión tornillo

| art. | Ø cm. | cm. | € |
|----------|-------|-----|------|
| 44167-13 | 2,2 | 130 | 5,13 |

Red lacquered iron. Lightweight and rustproof.
Ferro verniciato rosso. Leggero ed inossidabile.



Cotton mop, screw fitting

Mop in cotone, attacco filettato
Baumwollmop mit Schraubanschluss
Mop en coton avec attache à vis
Mopa de algodón

| art. | gr. | € |
|----------|-----|------|
| 44166-28 | 280 | 4,62 |



Telescopic rod

Manico telescopico
Teleskopstange
Manche telescopique
Mango telescópico

| art. | Ø cm. | cm. | € |
|----------|-------|--------|-------|
| 44161-00 | 2,3 | 97>184 | 25,33 |

Two-piece anodized aluminum rod.
Alluminio anodizzato due pezzi.



Mop holder

Pinza per mop
Wischmophalter
Pince faubert
Pinza

| art. | € |
|----------|------|
| 44164-00 | 5,93 |

Universal ring allows the use of any handle with from Ø 20 to 24 mm. – Ghiera universale consente l'utilizzo di qualsiasi manico con Ø 20>24 mm.



Cotton-end string mop

Mop a strisce in cotone
Spaghetti-Mop mit Baumwollend
Frangè à ficelles en coton
Mopa de algodón

| art. | gr. | € |
|----------|-----|------|
| 44165-35 | 350 | 7,44 |
| 44165-40 | 400 | 8,04 |
| 44165-50 | 500 | 9,35 |



Microfibre cloth, 24 pcs

Panno in microfibra, 24 pz
Mikrofasertuch, 24 Stk
Carré en microfibre, 24 pcs
Paño de microfibra, 24 pz

| art. | cm. | col. | € |
|----------|-------|------|-------|
| 44147-30 | 30x30 | ● | 29,35 |
| 44147-31 | 30x30 | ● | 29,35 |
| 44147-32 | 30x30 | ● | 29,35 |
| 44147-33 | 30x30 | ● | 29,35 |

Removes 99.9% of microbes. Launderable up to 100 times with bleach and 200 without bleach.
Rimuove il 99,9% dei microbi. Resiste fino a 200 lavaggi e 100 candeggi.



PP

Floor sign, 2-sided

Cavalletto segnalazione a 2 lati
Warnschild, 2-seitig
Panneau d'avertissement 2 côtés
Señal de suelo 2 lados

| art. | h. cm. | € |
|----------|--------|-------|
| 44077-00 | 57 | 28,84 |
| 44077-CC | 67 | 65,12 |



Telescopic door sign

Segnalatore telescopico di sicurezza
Teleskop-Sicherheitstürschild
Panneau de sécurité télescopique
Señal de seguridad telescópico

| art. | cm. | € |
|----------|-------------|-------|
| 44077-10 | 63,5x2,5x33 | 74,97 |

Aluminium/Vinyl. Width open 112 cm. Extendable pole to block out doorways and entrances.
Alluminio/Vinile. Larghezza aperto 112 cm. Palo estensibile per bloccare porte e ingressi.



PP

Multi-purpose trolley

Carrello multiuso
Allzweckwagen
Chariot multi-usage
Carro de limpieza

| art. | cm. | € |
|----------|-----------|--------|
| 44173-00 | 97x68x111 | 632,75 |

Bag holder with cover, bag lt. 120, pan with hooks, 2 buckets 4 lt. and 2 buckets 15 lt., wringer. – Portasacco con cop., sacco lt. 120, vaschetta con ganci, 2 secchi 4 lt., 2 secchi 15 lt. 15, strizzatore.



PP

Mopping trolley with press

Carrello lavapavimenti con strizzatore
Wringer Reinigungswagen mit Presse
Chariot de ménage avec presse
Carro con prensa escurridora

| art. | cm. | € |
|----------|----------|--------|
| 44171-24 | 62x42x90 | 228,24 |

Wringer and 25 lt. bucket. With storage compartment. PSV reinforced handle.
Strizzatore e 1 secchio lt. 25. Vano portaoggetti. Impugnatura in PSV completa di rinforzi.



PP

Mopping trolley with press

Carrello lavapavimenti con strizzatore
Wringer Reinigungswagen mit Presse
Chariot de ménage avec presse
Carro con prensa escurridora

| art. | cm. | € |
|----------|----------|--------|
| 44171-50 | 69x42x90 | 225,52 |

Wringer and 2 buckets lt. 25 each. Painted handle, reversible. – Strizzatore e 2 secchi da lt. 25. Impugnatura verniciata, reversibile.



PP

Mopping trolley with press

Carrello lavapavimenti con strizzatore
Wringer Reinigungswagen mit Presse
Chariot de ménage avec presse
Carro con prensa escurridora

| art. | cm. | € |
|----------|----------|--------|
| 44172-30 | 47x40x93 | 186,53 |

Single tank with wringer.
Monovasca con strizzatore.



PP

Graduated bucket

Secchio graduato
Eimer mit Skala
Seau gradué
Cubo con medidas

| art. | cm. | lt. | col. | € |
|----------|------------|-----|------|-------|
| 44169B06 | 24x19x21,5 | 6 | ● | 13,17 |
| 44169R06 | 24x19x21,5 | 6 | ● | 13,17 |



PP

Graduated bucket

Secchio graduato
Eimer mit Skala
Seau gradué
Cubo con medidas

| art. | cm. | lt. | col. | € |
|----------|------------|-----|------|-------|
| 44169B14 | 34x33,5x28 | 15 | ● | 23,52 |
| 44169R25 | 37x36,5x32 | 25 | ● | 23,52 |



PP

Bucket with wringer

Secchio con strizzatore
Eimer mit Presse
Seau avec essoreur
Cubo con prensa

| art. | cm. | lt. | € |
|----------|------------|-----|-------|
| 44168-12 | 35x27x29,5 | 12 | 13,87 |

With graduated scale 0-12 lt.
Scala graduata 0-12 lt.



PP

Waste container

Cestino
Abfallbehälter
Collecteur
Papelera

| art. | Ø cm. | h. cm. | lt. | € |
|----------|-------|--------|------|------|
| 44097-00 | 30 | 31,5 | 15,9 | 5,93 |



PE

Waste container SLIM JIM

Contentore rifiuti
Abfallbehälter
Collecteur
Colector

| art. | cm. | lt. | € |
|----------|----------|-----|--------|
| 49931-60 | 59x28X63 | 60 | 106,33 |
| 49931-87 | 56x28X76 | 87 | 154,27 |



PP

Hinged lid

Coperchio ancorato
Klapp-Deckel
Couvercle à charnière
Tapa abatible

| art. | cm. | € |
|----------|-----------|-------|
| 49931-00 | 55,6x34x3 | 80,30 |



PP

Lid

Coperchio
Deckel
Couvercle
Tapa

| art. | cm. | col. | € |
|----------|---------|------|-------|
| 49931A00 | 52x29x7 | ● | 78,59 |
| 49931C04 | 52x29x7 | ● | 78,59 |
| 49931B05 | 52x29x7 | ● | 78,59 |



PP

Dolly SLIM JIM

Carrello
Transportwagen
Chariot
Carrito

| art. | cm. | € |
|----------|--------------|--------|
| 49931-64 | 60,6x37,4X21 | 207,83 |

Side clip allows to tow together more trolleysdal release fast and simple. – Aggancio laterale a clip che permette di trainare insieme diversi carrelli. Rilascio a pedale semplice e veloce.



NEW

PP

Waste bin

Bidoncino
Abfallbehälter
Poubelle
Colector

| art. | cm. | lt. | col. | € |
|----------|----------|-----|------|-------|
| 44084-01 | 37x37x41 | 25 | ● | 22,51 |
| 44084-02 | 37x37x41 | 25 | ● | 22,51 |
| 44084-03 | 37x37x41 | 25 | ● | 22,51 |
| 44084-04 | 37x37x41 | 25 | ● | 22,51 |

Stackable and nestable. Easy emptying system thanks to ergonomic grips on the bottom, reinforced hinges to allow a 270° opening. Provided with a hinged and anti stray lid, ergonomic handle with vertical locking. Made from polypropylene compound, 100% recyclable, weather, chemical and UV resistant allowing it to be safely used outside.



NEW

PP

Waste bin

Bidoncino
Abfallbehälter
Poubelle
Colector

| art. | cm. | lt. | col. | € |
|----------|----------|-----|------|-------|
| 44085-01 | 37x37x52 | 35 | ● | 25,23 |
| 44085-02 | 37x37x52 | 35 | ● | 25,23 |
| 44085-03 | 37x37x52 | 35 | ● | 25,23 |
| 44085-04 | 37x37x52 | 35 | ● | 25,23 |

Impilabile e inseribile. Presa sul fondo per un facile svuotamento, coperchio con cerniere rinforzate per una apertura a 270°. Dotato di sportello basculante a becco e coperchio con meccanismo antirandagismo e maniglione con blocco verticale. Realizzato in compound di Polipropilene (PP) riciclabile al 100%, resistente agli agenti atmosferici, chimici ai raggi UV per utilizzo intensivo all'esterno.



PE
PC

Step on bin
Pattumiera a pedale
Pedaleimer
Poubelle à pédale
Colector a pedal

| art. | cm. | lt. | € |
|----------|----------|-----|---|
| 49933-50 | 53x34x72 | 50 | - |



NEW
PE

Step on bin
Pattumiera a pedale
Pedaleimer
Poubelle à pédale
Colector a pedal

| art. | cm. | lt. | € |
|----------|--------------|-----|--------|
| 49929R30 | 41,3x40x43,5 | 30 | 264,42 |
| 49929R45 | 41,3x40x60 | 45 | 318,69 |
| 49929R68 | 50,2x41x67,3 | 68 | 373,96 |
| 49929R87 | 50,2x41x82,6 | 87 | 527,73 |



NEW
PE

Step on bin
Pattumiera a pedale
Pedaleimer
Poubelle à pédale
Colector a pedal

| art. | cm. | lt. | € |
|----------|--------------|-----|--------|
| 49929W30 | 41,3x40x43,5 | 30 | 264,42 |
| 49929W45 | 41,3x40x60 | 45 | 318,69 |
| 49929W87 | 50,2x41x82,6 | 87 | 527,73 |



PE

Mobile pedal bin
Pattumiera a pedale
Pedaleimer
Poubelle à pédale
Colector a pedal

| art. | cm. | lt. | € |
|----------|----------|-----|--------|
| 44095-12 | 48x55x93 | 120 | 195,17 |

Certified UNI EN 840. Withstanding chemical, can be washed and sterilized. – Certificata UNI EN 840. Resistente agli agenti chimici, lavabile e sterilizzabile.



PP

Mobile pedal bin
Pattumiera a pedale
Pedaleimer
Poubelle à pédale
Colector a pedal

| art. | cm. | lt. | € |
|----------|----------|-----|-------|
| 44095-18 | 40x65x81 | 80 | 91,05 |



PP

Mobile pedal bin
Pattumiera a pedale
Pedaleimer
Poubelle à pédale
Colector a pedal

| art. | cm. | lt. | col. | € |
|----------|----------|-----|------|-------|
| 44096-80 | 48x50x78 | 80 | ○ | 96,48 |
| 44096B80 | 48x50x78 | 80 | ● | 96,48 |
| 44096Y80 | 48x50x78 | 80 | ● | 96,48 |
| 44096R80 | 48x50x78 | 80 | ● | 96,48 |
| 44096G80 | 48x50x78 | 80 | ● | 96,48 |



Refuse bag holder trolley
Carrello portasacco
Sackhalterwagen
Chariot porte-sac
Colector móvil

| art. | cm. | lt. | € |
|----------|-----------|-----|--------|
| 44089-12 | 58x56x102 | 120 | 157,58 |

Coated iron foldable frame. Round bag holder, pivouetting wheels Ø 80 mm. – Telaio pieghevole in acciaio verniciato. Portasacco rotondo. Ruote piroettanti Ø 80 mm.



PP

Mobile pedal bin
Pattumiera a pedale
Pedaleimer
Poubelle à pédale
Colector a pedal

| art. | cm. | lt. | col. | € |
|----------|----------|-----|------|--------|
| 49899-01 | 46x32x80 | 70 | ● | 231,05 |

Mechanical parts in stainless steel. The lid can be removed. – Parti meccaniche in acciaio inox. Coperchio staccabile.



PP

Pedal bin lids
Coperchi pattumiera
Pedaleimer-Deckel
Couvercles poubelle
Tapas para colector

| art. | cm. | col. | € |
|----------|-------|------|-------|
| 49899-91 | 46x32 | ● | 35,48 |
| 49899-92 | 46x32 | ● | 35,48 |
| 49899-93 | 46x32 | ● | 35,48 |
| 49899-94 | 46x32 | ● | 37,59 |
| 49899-95 | 46x32 | ● | 37,59 |





PE

Tilt truck

Benna ribaltabile
Falten Eimerwagen
Benne
Carrito plegable

| art. | cm. | lt. | Kg. | € |
|----------|------------|-----|-----|----------|
| 49934-04 | 145x68x86 | 400 | 205 | 1.592,02 |
| 49934-06 | 164x77x97 | 600 | 272 | 1.934,02 |
| 49934-08 | 180x85x107 | 800 | 570 | 2.805,36 |



PE

Domed linged lid

Coperchio a doppia apertura
Doppel-Deckel
Couverture double
Tapa doble

| art. | cm. | € |
|----------|-----------|--------|
| 49934-14 | 132x71x23 | 496,47 |
| 49934-16 | 155x81x23 | 592,35 |
| 49934-18 | 169x87x23 | 701,39 |



PE

Pallet

Pallet
Pallet
Palette
Racks para suelos

| art. | cm. | Kg. | € |
|----------|-----------|-----|-------|
| 49373-05 | 80x120x14 | 4,6 | 74,37 |

Static load 1000 kg. Appropriate for food.
Carico statico 1000 kg. Per uso alimentare.



Dunnage rack

Pedana
Lageruntersätze
Palettes
Bancada

| art. | cm. | load kg | € |
|----------|--------------|---------|--------|
| 49371-09 | 91,4x56x30,5 | 68 | 552,35 |
| 49371-12 | 122x56x30,5 | 136 | 640,69 |

Rust and corrosion-proof polymer material.
Materiale polimerico resistente alla ruggine e alla corrosione.



PP

Standing ashtray

Posacenere/fioriera
Standascher
Cendrier sur pied
Cenicero

| art. | Ø cm. | h. cm. | € |
|----------|-------|--------|--------|
| 49892-40 | 40 | 60 | 128,24 |

Included bag of sand 1,5 kg.
Incl. sacchetto sabbia kg 1,5.

RETRACTABLE BARRIERS ASTE DELIMITA CORSIE

Tubular structure in stainless steel matte finish or black lacquered ø 63 mm, thickness 0,8 mm. 4-way retractable polyester black belt length 2,13 meters, width 4,8 cm. Ballasted base ø cm 31 with rubber under the base. Weight 10 kg. Overall height 1 mt. Possibility to apply landscape display.

Struttura tubolare in acciaio inossidabile finitura satinata o laccata nera ø 63 mm, spessore 0,8 mm. Nastro retrattile 4-vie in poliestere nero lunghezza 2,13 metri, larghezza 4,8 cm. Base zavorrata ø 31 cm con gomma sotto la base. Peso 10 kg. Altezza totale 1 mt. Possibilità di applicare tabella segnaletica.



Retractable barrier set

Set aste delimita corsie a nastro estensibile

Absperrpfost mit einziehbarer Gurt, 2 Stk

Set poteaux avec ceinture rétractable

Juego de columnas móviles con cinta retráctil

| art. | Ø cm. | base Ø cm. | belt/nastro | h. cm. | Kg. | € |
|----------|-------|------------|-------------|--------|-----|-------|
| 44183-01 | 6,3 | 36 | cm 213x4,8 | 100 | 10 | 66,90 |

Black laquered. – Laccato nero.



Retractable barrier set

Set aste delimita corsie a nastro estensibile

Absperrpfost mit einziehbarer Gurt, 2 Stk

Set poteaux avec ceinture rétractable

Juego de columnas móviles con cinta retráctil

| art. | Ø cm. | base Ø cm. | belt/nastro | h. cm. | Kg. | € |
|----------|-------|------------|-------------|--------|-----|-------|
| 44184-01 | 6,3 | 36 | cm 213x4,8 | 100 | 10 | 76,50 |

Stainless steel matt finish. – Inox finitura satinata.



Post top sign holder

Tabella

Posterhalter

Porte-enseigne

Cartelera

| art. | cm. | € |
|----------|--------|-------|
| 44183-A4 | DIN-A4 | 41,00 |
| 44183-A3 | DIN-A3 | 49,00 |

Black laquered. – Laccato nero.



Post top sign holder

Tabella

Posterhalter

Porte-enseigne

Cartelera

| art. | cm. | € |
|----------|--------|-------|
| 44184-A4 | DIN-A4 | 43,80 |
| 44184-A3 | DIN-A3 | 51,40 |

Stainless steel matt finish. – Inox finitura satinata.



ELECTRIC APPLIANCES APPARECCHI ELETTRICI



**Dualit.****4 slot toaster**

Tostapane 4 fette
 Brotröster
 Grille pain
 Tostadora

| art. | cm. | Kg. | kW | € |
|----------|----------|------|-----|--------|
| 49801-04 | 36x21x22 | 4,25 | 2,2 | 563,00 |

**Dualit.****6 slot toaster**

Tostapane 6 fette
 Brotröster
 Grille pain
 Tostadora

| art. | cm. | Kg. | kW | € |
|----------|----------|-----|----|--------|
| 49801-06 | 46x21x22 | 5,1 | 3 | 693,05 |

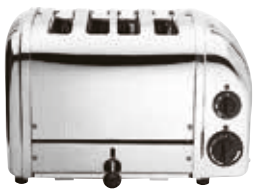
**Dualit.****4 slice bun toaster**

Tostapane 4 fette
 Brotröster
 Grille pain
 Tostadora

| art. | cm. | Kg. | kW | € |
|----------|----------|------|----|--------|
| 49802-04 | 36x21x22 | 4,52 | 1 | 563,00 |

**Dualit.****6 slice bun toaster**

Tostapane 6 fette
 Brotröster
 Grille pain
 Tostadora

| art. | cm. | Kg. | kW | € |
|----------|----------|------|-----|--------|
| 49802-06 | 46x21x22 | 5,52 | 1,5 | 693,05 |

**Dualit.****Conveyor Toaster**

Tostapane a nastro
 Durchlauf-Toaster
 Toaster convoyeur
 Tostador a túnel

| art. | cm. | Kg. | kW | € |
|----------|------------|-----|-----|----------|
| 49803-02 | 44x43x41,3 | 14 | 2,7 | 2.207,99 |

**Conveyor toaster, CT540 B**

Tostapane a nastro doppia uscita
 Durchlauftoast
 Toaster convoyeur
 Tostador a túnel

| art. | cm. | Kg. | kW | € |
|----------|------------|-----|------|----------|
| 49850-20 | 50x68x34,5 | 20 | 2,65 | 2.627,37 |





Toaster, BAR 1000

Tostapane
Toast-/Überbackgerät
Toaster
Tostador de pan

| art. | cm. | Kg. | kW | € |
|----------|--------------|-----|----|--------|
| 49850-65 | 45x28,5x30,5 | 10 | 2 | 531,95 |



Contact grill, SAVOYE

Grill a contatto
Kontaktgrill
Grill à contact
Grill de contacto

| art. | cm. | Kg. | kW | € |
|----------|------------|-----|----|----------|
| 49850-22 | 33x38,5x22 | 18 | 2 | 1.088,82 |



Contact grill, PANINI

Grill a contatto
Kontaktgrill
Grill à contact
Grill de contacto

| art. | cm. | Kg. | kW | € |
|----------|------------|------|----|----------|
| 49850-21 | 43x38,5x22 | 22,5 | 3 | 1.317,15 |



Contact grill double plate, MAJESTIC

Grill a contatto doppia piastra
Kontaktgrill, 2 Platten
Grill à contact, 2 plaques
Grill de contacto doble

| art. | cm. | Kg. | kW | € |
|----------|------------|------|-----|----------|
| 49850-23 | 60x38,5x22 | 33,5 | 2x2 | 1.608,00 |



Contact sandwich toaster

Grill a contatto
Sandwich-Toaster
Appareil croque monsieur
Grill de contacto

| art. | cm. | Kg. | kW | € |
|----------|----------|-----|-----|--------|
| 49806-00 | 40x22x19 | 6 | 1,6 | 613,85 |

Dualit.



Contact grill, PANINI XL

Grill a contatto
Kontaktgrill
Grill à contact
Grill de contacto

| art. | cm. | Kg. | kW | € |
|----------|----------|-----|-----|----------|
| 49850-19 | 41x62x34 | 32 | 3,6 | 1.559,96 |



**Glas ceramic contact grill, GVS 335**

Grill a contatto vetroceramica
 Kontaktgrill, Glaskeramik-Platte
 Grill à contact vitrocéramique
 Grill de contacto vitrocerámica

| art. | cm. | Kg. | kW | € |
|----------|----------|-----|----|----------|
| 49850-18 | 39x60x26 | 14 | 3 | 1.713,42 |

**Salamander, SEM 600 PDS**

Salamandra
 Salamandrs mit PDS
 Salamandre avec détection de plat
 Salamandra con PDS

| art. | cm. | Kg. | kW | € |
|----------|----------|-----|----|----------|
| 49850-71 | 60x64x59 | 56 | 3 | 4.108,64 |

**Hot dog heater, CS 3 E**

Scalda würstel
 Würstchenwärmer
 Chauffe-saucisses
 Calentador de salchichas

| art. | cm. | Kg. | kW | € |
|----------|----------|-----|------|--------|
| 49850-61 | 44x30x40 | 9 | 0,65 | 985,20 |

**Kebab/Gyros grill, GR 40 E**

Griglia kebab/gyros
 Elektro-Dönergrill
 Gril à kebab/gyros
 Asador de kebab/gyros

| art. | cm. | Kg. | kW | € |
|----------|------------|-----|-----|----------|
| 49850-13 | 58x66x69,5 | 15 | 3,6 | 2.348,79 |

**Kebab/Gyros grill, GR 60 E**

Griglia kebab/gyros
 Elektro-Dönergrill
 Gril à kebab/gyros
 Asador de kebab/gyros

| art. | cm. | Kg. | kW | € |
|----------|----------|-----|-----|----------|
| 49850-14 | 58x66x87 | 25 | 5,8 | 2.620,24 |

**Crepe machine, high-capacity, CFE 400**

Crepiera tonda, ad alto rendimento
 Crêpegerät
 Crêpière à haut rendement
 Crepera

| art. | Ø cm. | h. cm. | Kg. | kW | € |
|----------|-------|--------|-----|-----|--------|
| 49850-33 | 40 | 20 | 18 | 3,6 | 760,38 |





Crepe machine, CSE 400

Creperia
Crêpegerät
Crêpière
Crepera

| art. | Ø cm. | cm. | Kg. | kW | € |
|----------|-------|----------|-----|-----|----------|
| 49850-11 | 40 | 45x50x24 | 23 | 3,6 | 1.163,79 |



Eggs boiler, CO 60

Bollitore uova
Eierkocher
Cuiseur à oeuf

Caldera para huevos

| art. | cm. | Kg. | kW | € |
|----------|--------------|-----|-----|--------|
| 49850-36 | 21,5x43x25,5 | 4,5 | 1,2 | 638,98 |



Multifunction oven, FC 280

Forno multifunzione
Multifunktionsofen
Four multifonctions
Horno multifunción

| art. | cm. | Kg. | kW | € |
|----------|------------|-----|-----|----------|
| 49850-73 | 46x55x35,5 | 20 | 1,5 | 1.053,04 |



Multifunction oven, FC 380 TQ

Forno multifunzione
Multifunktionsofen
Four multifonctions
Horno multifunción

| art. | cm. | Kg. | kW | € |
|----------|------------|-----|-----|----------|
| 49850-75 | 55x55x35,5 | 22 | 2,4 | 1.438,56 |



Multifunction oven, FC 60 TQ

Forno multifunzione
Multifunktionsofen
Four multifonctions
Horno multifunción

| art. | cm. | Kg. | kW | € |
|----------|------------|-----|----|----------|
| 49850-76 | 59,5x61x59 | 38 | 3 | 1.984,67 |



Fryer, FD 80 R

Friggitrice
Friteuse
Friteuse
Freidora

| art. | cm. | kg./H | Kg. | kW | € |
|----------|------------|-------|-----|-----|--------|
| 49850-41 | 26,5x45x36 | 15 | 8 | 3,6 | 838,87 |





Fryer, FD 80 DR

Friggitrice
Fritteuse
Friteuse
Freidora

| art. | cm. | kg./H | Kg. | kW | € |
|----------|----------|-------|-----|-------|----------|
| 49850-42 | 59x45x37 | 30 | 15 | 2x3,6 | 1.510,01 |



Fryer, FD 50

Friggitrice
Fritteuse
Friteuse
Freidora

| art. | cm. | kg./H | Kg. | kW | € |
|----------|--------------|-------|-----|-----|--------|
| 49850-37 | 21,5x42,5x32 | 10 | 5 | 3,2 | 515,77 |



Dish-warmer, DW106 / 110

Scaldapiatti
Rechaud
Chauffe plats
Calentador de platos

| art. | cm. | Kg. | kW | € |
|----------|--------------|-----|------|----------|
| 49850-06 | 40x21,5x33,5 | 14 | 0,65 | 1.117,36 |
| 49850-10 | 40x21,5x47,5 | 25 | 1,3 | 1.606,39 |



Ventilated warming display, WD 780 DI

Espositore caldo ventilato
Konvektion-Warme Theke
Présentoir chaud à convection
Expositor caliente con convección

| art. | cm. | Kg. | kW | € |
|----------|----------|-----|-----|----------|
| 49850-70 | 78x49x64 | 35 | 1,8 | 2.170,40 |

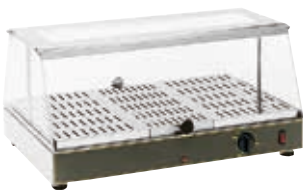

Warming display

Vetrina riscaldata
Warmhalte-Vitrine
Vitrine chauffante
Vitrina caliente

| art. | GN | cm. | Kg. | kW | range | € |
|----------|-----|------------|-----|------|-----------|--------|
| 49850-43 | 1/1 | 59x35x28,5 | 12 | 0,65 | +20 +95°C | 842,49 |



Warming display

Vetrina riscaldata
Warmhalte-Vitrine
Vitrine chauffante
Vitrina caliente

| art. | GN | cm. | Kg. | kW | range | € |
|----------|--------|----------|-----|------|-----------|----------|
| 49850-44 | 2x 1/1 | 59x35x39 | 15 | 0,65 | +20 +95°C | 1.156,65 |

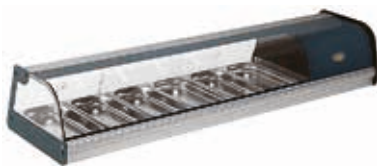

Tapas display

Vetrina antipasti
Vorspeisen-Schaufenster
Vitrine tapas
Vitrina para tapas

| art. | cm. | Kg. | W | range | € |
|----------|-----------|-----|-----|---------|----------|
| 49630-06 | 145x40x26 | 33 | 160 | +2/+5°C | 2.563,05 |



Ice cream maker

Macchina per gelato
Eismaschine
Machine à glace
Maquinas helado

| art. | cm. | lt. | kg./H | Kg. | kW | € |
|----------|----------|-----|-------|-----|-----|----------|
| 49949-19 | 51x31x35 | 1,5 | 3 | 30 | 0,4 | 1.628,10 |





Dehydrator for fruits and vegetables

Disidratatore per frutta e verdura

Dehydratisierapparat

Déshydrateur fruits et légumes

Deshidratador de frutas y verduras

| art. | cm. | Kg. | kW | range | € |
|----------|------------|-----|------|-----------|--------|
| 49953-02 | 43,5x29x21 | 3,6 | 0,53 | +30 +80°C | 460,49 |

Supplied with 6 reversible trays. Timer up to 72 hours.

6 vassoi reversibili. Timer fino a 72 ore.



Smoker, 2 levels

Affumicatoio a 2 piani

Räucherofen

Fumoir

Ahumador

| art. | cm. | Kg. | kW | € |
|----------|----------|-----|-----|----------|
| 49850-63 | 45x45x35 | 25 | 1,5 | 2.788,17 |



Table-top cutter

Cutter da tavolo

Gemüseschneidmaschine

Cutter à légumes

Cortador verduras

| art. | cm. | lt. | Kg. | V | € |
|----------|----------|-----|-----|-------------|----------|
| 49979-03 | 32x52x62 | 3 | 12 | 115-220-240 | 1.129,22 |

Single phase. Anodised aluminium, s/s container and blades, transparent lid.

Monofase. Alluminio anodizzato, contenitore e lame inox, coperchio trasparente.



Electric peeler

Pelatrice elettrica

Elektr. Schälmaschine

Eplucheur électrique

Pelador eléctrico

| art. | cm. | Kg. | € |
|----------|------------|-----|--------|
| 49750-00 | 25x16x21,5 | 2 | 533,96 |



Dualit.

Waffle iron

Macchina per cialde

Waffeleisen

Gufrier

Gofrera

| art. | cm. | Kg. | kW | € |
|----------|----------|-----|-----|--------|
| 49809-00 | 40x22x19 | 5,5 | 1,6 | 613,85 |



**Single waffle iron, GESIMPLE**

Macchina per cialde
Waffeleisen mit 1 Platte
Gaufrier simple
Gofrera singular

| art. | cm. | Kg. | kW | € |
|----------|------------|-----|-----|----------|
| 49850-24 | 30,5x44x23 | 22 | 1,6 | 1.377,86 |

Squares 20x25 mm.

**Single waffle iron, GESIMPLE**

Macchina per cialde
Waffeleisen mit 1 Platte
Gaufrier simple
Gofrera singular

| art. | cm. | Kg. | kW | € |
|----------|------------|-----|-----|----------|
| 49850-25 | 30,5x44x23 | 22 | 1,6 | 1.377,86 |

Squares 15x18 mm.

**Single waffle iron, GESIMPLE**

Macchina per cialde
Waffeleisen mit 1 Platte
Gaufrier simple
Gofrera singular

| art. | cm. | Kg. | kW | € |
|----------|------------|-----|-----|----------|
| 49850-26 | 30,5x44x23 | 22 | 1,6 | 1.377,86 |

**Single waffle iron, GESIMPLE**

Macchina per cialde
Waffeleisen mit 1 Platte
Gaufrier simple
Gofrera singular

| art. | cm. | Kg. | kW | € |
|----------|------------|-----|-----|----------|
| 49850-27 | 30,5x44x23 | 22 | 1,6 | 1.377,86 |

**Single waffle iron, GES23**

Macchina per cialde
Waffeleisen mit 1 Platte
Gaufrier simple
Gofrera singular

| art. | cm. | Kg. | kW | € |
|----------|------------|-----|-----|----------|
| 49850-03 | 30,5x44x23 | 22 | 1,6 | 1.424,29 |

**Infrared lamp with warming plate**

Lampada ad infrarossi con piano caldo
Infrarot Wärmebrücke mit Wärmeplatte
Lampe infrarouge avec plaque chauffante
Lámpara infrarrojos y placa caliente

| art. | GN | cm. | kW | € |
|----------|-----|-----------|-----|----------|
| 49993-21 | 1/1 | 38x53x70 | 0,5 | 800,78 |
| 49993-22 | 2/1 | 70x53x71 | 1,0 | 1.083,49 |
| 49993-23 | 3/1 | 103x53x70 | 1,5 | 1.400,97 |

Curved plexiglass fender. Separate switches for plate and lamps. Adjustable thermostat +30°C +90°C. – Parafiato in plexiglass curvo. Interruttori di accensione separati per piano caldo e lampade. Termostato regolabile +30°C +90°C.

**Infrared lamp**

Lampada ad infrarossi
Infrarot Wärmebrücke
Lampe infrarouge
Lámpara infrarrojos

| art. | GN | cm. | kW | € |
|----------|-----|-----------|------|----------|
| 49993-01 | 1/1 | 38x53x70 | 0,25 | 620,79 |
| 49993-02 | 2/1 | 70x53x71 | 0,50 | 818,27 |
| 49993-03 | 3/1 | 103x53x70 | 0,75 | 1.052,03 |

Curved plexiglass fender. – Parafiato in plexiglass curvo.

SS

SS





SS

Warming plate

Piano caldo
Wärmeplatte
Plaque chauffante
Placa caliente

| art. | GN | cm. | kW | € |
|----------|-----|----------|------|--------|
| 49993-11 | 1/1 | 33x53x6 | 0,25 | 347,53 |
| 49993-12 | 2/1 | 66x53x6 | 0,50 | 437,48 |
| 49993-13 | 3/1 | 132x53x6 | 0,75 | 525,92 |

Adjustable thermostat +30°C +90°C. – Termostato regolabile +30°C +90°C.



SS

Table with hot box

Tavolino con box termico
Tisch mit Hot Box
Table avec hot box
Carrito con hot box

| art. | Ø cm. | h. cm. | W | € |
|----------|---------|--------|-----|----------|
| 44094-04 | 90/54,6 | 78,6 | 500 | 2.352,50 |

Table with fold down flaps. With capsizable top for stacking when not in use. Tavolo con flaps pieghevoli. Ribaltabile e impilabile quando non in uso.



Mixer/liquidiser combi unit

Combi mixer/frusta
Kombigerät
Combiné mixeur-fouet
Brazo triturador/batidor, unidad combinada

| art. | h. cm. | Kg. | kW | rpm | € |
|----------|--------|------|------|-------|----------|
| 49907-01 | 79 | 4,95 | 0,35 | 15000 | 1.129,02 |

For containers up to 100 liters. – Per contenitori fino a 100 litri.



Liquidiser

Mixer
Stabmixer
Mixeur
Brazo triturador

| art. | h. cm. | Kg. | kW | rpm | € |
|----------|--------|------|------|-------|--------|
| 49907-06 | 55,5 | 1,45 | 0,25 | 15000 | 485,92 |

For containers up to 30 liters. – Per contenitori fino a 30 litri.



Wall rack

Supporto murale
Wandständer
Support murale
Soporte mural

| art. | € |
|----------|-------|
| 49907-AA | 59,70 |



Liquidiser

Mixer
Stabmixer
Mixeur
Brazo triturador

| art. | h. cm. | Kg. | kW | rpm | € |
|----------|--------|-----|------|------------|----------|
| 49911-24 | 24 | 1,4 | 0,27 | 2000:12500 | 752,04 |
| 49916-25 | 25 | 3,0 | 0,27 | 2300:9600 | 926,01 |
| 49916-35 | 35 | 3,3 | 0,35 | 2300:9600 | 1.164,09 |
| 49916-45 | 45 | 4,9 | 0,44 | 1500:9000 | 1.394,64 |
| 49916-55 | 55 | 5,2 | 0,75 | 9000 | 1.871,91 |



**Mixer/liquidiser combi unit**

Combi mixer/frusta

Kombigerät

Combiné mixeur-fouet

Brazo triturador/batidor, unidad combinada

| art. | h. cm. | Kg. | kW | rpm | € |
|----------|--------|-----|------|------------|----------|
| 49911-19 | 19 | 1,9 | 0,25 | 2000-12500 | 891,23 |
| 49911-30 | 30 | 3,1 | 0,30 | 2300-9600 | 1.572,22 |
| 49911-35 | 35 | 5,9 | 0,44 | 1500-9000 | 1.788,40 |
| 49911-45 | 45 | 6,1 | 0,50 | 1500-9000 | 1.923,47 |

**Table-top cutter R4**

Cutter da tavolo

Gemüeschneidmaschine

Cutter à légumes

Cortador verduras

| art. | cm. | lt. | Kg. | kW | rpm | € |
|----------|----------|-----|-----|-----|-----------|----------|
| 49943-01 | 21x32x43 | 4,5 | 17 | 0,9 | 1500/3000 | 3.329,87 |

**Table-top cutter R5 - 2V**

Cutter da tavolo

Gemüeschneidmaschine

Cutter à légumes

Cortador verduras

| art. | cm. | lt. | Kg. | kW | rpm | € |
|----------|------------|-----|-----|-----|-----------|----------|
| 49943-02 | 28x36,5x51 | 5,9 | 21 | 1,5 | 1500/3000 | 5.066,71 |

**Emulsifier-mixer Blixer 4**

Omogeneizzatore

Mixergerät

Emulsionneur-mixer

Omogenizador/emulsificador

| art. | cm. | lt. | Kg. | kW | rpm | € |
|----------|--------------|-----|-----|----|-----------|----------|
| 49944-01 | 46x22,5x30,5 | 4,5 | 18 | 1 | 1500/3000 | 3.675,69 |

**Emulsifier-mixer Blixer 4 V.V**

Omogeneizzatore

Mixergerät

Emulsionneur-mixer

Omogenizador/emulsificador

| art. | cm. | lt. | Kg. | kW | rpm | € |
|----------|--------------|-----|-----|-----|----------|----------|
| 49944-02 | 46x22,5x30,5 | 4,5 | 18 | 1,1 | 300-3500 | 4.570,24 |

**Juice extractor J80 Ultra**

Centrifuga

Fruchtpresse

Centrifugeur-presse agrumes

Centrifugadora/exprimidor jugos

| art. | cm. | kg./H | Kg. | kW | rpm | € |
|----------|--------------|-------|-----|-----|------|----------|
| 49949-20 | 23,5x42x50,5 | 60 | 11 | 0,7 | 3000 | 2.998,82 |





Vegetable preparation machine CL 50 Ultra

Tagliaverdure
Gemüeschneidmaschine
Coupe-légumes
Cortador verduras

| art. | cm. | Kg. | kW | rpm | € |
|----------|------------|-----|------|-----|----------|
| 49940-01 | 30x36x55,5 | 15 | 0,55 | 375 | 3.226,15 |

Suitable also for cutting mozzarella. For cutting discs contact our customer service. – Ideale anche per tagliare mozzarella. Per i dischi di taglio contatta il ns customer service.



Cutter & vegetable slicer R301 Ultra

Combinato cutter/tagliaverdure
Gemüeschneid- u. Schälmaschine
Cutter/Coupe-légumes
Cortador verduras

| art. | cm. | lt. | Kg. | kW | rpm | € |
|----------|------------|-----|-----|------|------|----------|
| 49942-01 | 28,5x36x40 | 3,7 | 14 | 0,65 | 1500 | 3.064,25 |

For cutting discs contact our customer service.
Per i dischi di taglio contatta il ns customer service.



Cutter & vegetable slicer R502 VV

Combinato cutter/tagliaverdure
Gemüeschneid- u. Schälmaschine
Cutter/Coupe-légumes
Cortador verduras

| art. | cm. | lt. | Kg. | kW | rpm | € |
|----------|------------|-----|-----|-----|----------|----------|
| 49942-03 | 38x36,5x67 | 5,9 | 30 | 1,3 | 300-3500 | 6.854,10 |

For cutting discs contact our customer service.
Per i dischi di taglio contatta il ns customer service.



Sieving juicer C80

Centrifuga
Passiermaschine
Centrifugeuse
Centrifugadora

| art. | cm. | kg./H | Kg. | kW | rpm | € |
|----------|----------|-------|-----|------|------|----------|
| 49946-01 | 61x36x54 | 50 | 21 | 0,65 | 1500 | 5.065,20 |



Citrus fruit squeezer

Spremiagrumi
Zitruspresse
Presse agrumes
Exprimidor cítricos

| art. | cm. | Kg. | kW | rpm | € |
|----------|----------|-----|------|------|--------|
| 49922-01 | 20x30x35 | 5 | 0,13 | 1500 | 776,76 |



Citrus fruit squeezer

Spremiagrumi
Zitruspresse
Presse agrumes
Exprimidor cítricos

| art. | cm. | Kg. | kW | rpm | € |
|----------|--------------|-----|------|-----------|----------|
| 49922-02 | 20,5x30,5x49 | 10 | 0,23 | 1500-1800 | 1.350,42 |



**Citrus fruit squeezer**

Spremiagrumi
Zitruspresse
Presse agrumes
Exprimidor cítricos

| art. | cm. | Kg. | kW | rpm | € |
|----------|----------|-----|------|-----------|----------|
| 49922-03 | 20x30x38 | 10 | 0,23 | 1500-1800 | 1.483,68 |

**Citrus fruit squeezer**

Spremiagrumi
Zitruspresse
Presse agrumes
Exprimidor cítricos

| art. | cm. | Kg. | kW | rpm | € |
|----------|----------|-----|-------|-----------|----------|
| 49922-04 | 24x40x49 | 10 | 0,275 | 1500-1800 | 1.694,33 |

**Juice extractor**

Centrifuga, spremisucchi
Fruchtpresse
Centrifugeur-presse agrumes
Centrifugadora/exprimidor jugos

| art. | cm. | Kg. | kW | rpm | € |
|----------|----------|-----|-----|-----------|----------|
| 49922-06 | 26x47x45 | 16 | 0,8 | 3000-3300 | 3.033,59 |

**Ice crusher**

Spaccaghiaccio
Eiszerstosser
Broyeur à glace
Triturador de hielo

| art. | cm. | Kg. | kW | rpm | € |
|----------|----------|-----|------|-------|----------|
| 49922-08 | 24x35x47 | 10 | 0,13 | 73-89 | 2.107,18 |

**Drink Mixer**

Frullino frappè
Getränkemixer
Shaker électrique
Batidora para batidos

| art. | cm. | Kg. | kW | rpm | € |
|----------|------------|-----|------|------------|----------|
| 49949-09 | 18,6x18x53 | 6 | 0,12 | 8000-16000 | 1.223,99 |

Equipped with 3 stirrers and 2 bowls, s/s and polycarbonate.
Fornito di 3 utensili agitatori e 2 bicchieri, inox e policarbonato.

**Blender**

Frullatore
Getränkemixer
Mixeur
Licuadora

| art. | cm. | lt. | Kg. | kW | rpm | € |
|----------|------------|-----|-----|-----|-----------|----------|
| 49922-22 | 30x22x56,6 | 2 | 11 | 1,2 | 500-15000 | 2.552,10 |
| 49922-23 | 30x22x56,6 | 4 | 11 | 1,2 | 500-15000 | 2.656,52 |

Stainless steel bowl. – Bicchiere inox.





Blender
Frullatore
Getränkemixer
Mixeur
Licuadora

| art. | cm. | lt. | Kg. | kW | rpm | € |
|----------|------------|-----|-----|-----|-----------|----------|
| 49922-20 | 30x22x56,6 | 2 | 11 | 1,2 | 500-15000 | 2.130,20 |
| 49922-21 | 30x22x56,6 | 4 | 11 | 1,2 | 500-15000 | 2.145,37 |

Clear bowl BPA Free. – Bicchiere trasparente BPA Free.



Blender
Frullatore
Getränkemixer
Mixeur
Licuadora

| art. | cm. | Kg. | kW | € |
|----------|----------|-----|----|----------|
| 49922-09 | 20x47x44 | 9 | 3 | 3.536,80 |

Clear bowl BPA Free. – Bicchiere trasparente BPA Free.



Citrus fruit squeezer
Spremiagrumi
Zitruspresse mit Spritzschutz
Presse agrumes
Exprimidora

| art. | cm. | Kg. | kW | rpm | € |
|----------|----------|-----|-----|------|--------|
| 49958-00 | 31x22x34 | 8 | 0,3 | 1400 | 768,22 |



Lever citrus fruit squeezer
Spremiagrumi a leva
Zitruspresse mit Pressarm
Presse agrumes à levier
Exprimidora

| art. | cm. | Kg. | kW | rpm | € |
|----------|----------|-----|------|------|----------|
| 49959-00 | 31x22x35 | 9 | 0,34 | 1400 | 1.127,41 |



Blender
Frullatore
Getränkemixer
Mixeur
Licuadora

| art. | cm. | lt. | Kg. | kW | rpm | € |
|----------|----------|-----|-----|-----|-------------|--------|
| 49956-01 | 20x20x46 | 1,7 | 4 | 0,4 | 10000-15000 | 734,35 |

Plastic bowl. – Bicchiere plastica.



Blender
Frullatore
Getränkemixer
Mixeur
Licuadora

| art. | cm. | lt. | Kg. | kW | rpm | € |
|----------|----------|-----|-----|----|-------------|----------|
| 49957-00 | 23x23x52 | 3 | 5,5 | 1 | 12000-22000 | 1.232,73 |

Stainless steel bowl. – Bicchiere inox.





Ice crusher
Tritaghiaccio
Eiszerstosser
Broyeur à glace
Trituradora de hielo

| art. | cm. | Kg. | kW | rpm | € |
|----------|----------|-----|------|------|----------|
| 49960-00 | 42x21x29 | 11 | 0,34 | 1400 | 1.214,94 |



Drink mixer
Frullino
Getränkemixer
Shaker électrique
Licuadora

| art. | cm. | lt. | Kg. | kW | rpm | € |
|----------|----------|-----|-----|------|-------|--------|
| 49955-01 | 20x22x50 | 0,8 | 2,8 | 0,12 | 15000 | 488,53 |

Plastic bowl. – Bicchiera plastica.



Rice steamer
Cuoci riso a vapore
Reiskocher
Cuit riz
Olla arrocera

| art. | Ø cm. | h. cm. | lt. | kW | € |
|----------|-------|--------|-----|----|--------|
| 49954-21 | 5,0 | 35 | 21 | 3 | 418,48 |



Water boiler with tap
Bollitore per acqua con rubinetto
Wasserkocher mit Hahn
Chauffe-eau avec robinet
Calentador de agua con grifo

| art. | Ø cm. | h. cm. | lt. | Kg. | V | kW | € |
|----------|-------|--------|-----|-----|-----|-----|--------|
| 49954-20 | 37 | 48 | 20 | 5,7 | 230 | 2,1 | 646,22 |

+30°C +100°C

SS



Planetary mixer
Impastatrice planetaria
Knet- u. Schlagmaschine
Batteur-mélangeur
Batodira planetaria

| art. | cm. | lt. | Kg. | kW | rpm | € |
|----------|----------|-----|-----|------|------|----------|
| 49947-08 | 30x40x58 | 7,6 | 27 | 0,18 | 1420 | 3.187,36 |

3 speeds. Timer 0-15 min. – 3 velocità. Timer 0-15 min.



Planetary mixer
Impastatrice planetaria
Knet- u. Schlagmaschine
Batteur-mélangeur
Batodira planetaria

| art. | cm. | lt. | Kg. | kW | rpm | € |
|----------|------------|-----|-----|------|--------|----------|
| 49945-05 | 38x31x45,5 | 5 | 15 | 0,75 | 40x260 | 2.118,24 |

10 speeds. – 10 velocità.





SS

Microwave oven - PROG

Forno microonde
Mikrowelle
Four à micro-ondes
Microonda

| art. | cm. | lt. | Kg. | W | € |
|----------|----------|-----|------|------|----------|
| 49997-12 | 51x43x31 | 26 | 14,7 | 1000 | 1.331,93 |

Time key X2. 3 cooking stages, 5 power levels. 10 programmable keys. 100 programs. GN 1/2 fixed glass ceramic bottom. – Tasto tempo X2. 3 stadi cottura. 5 livelli di potenza. 10 tasti programmabili. 100 programmi. Fondo fisso in vetroceramica GN 1/2.



SS

Microwave oven - SELF

Forno microonde
Mikrowelle
Four à micro-ondes
Microonda

| art. | cm. | lt. | Kg. | W | € |
|----------|----------|-----|------|------|----------|
| 49997-13 | 51x43x31 | 26 | 14,7 | 1550 | 1.331,93 |

To heat and regenerate food. Customizable time and temperature settings.
Per scaldare e rigenerare gli alimenti. Impostazioni tempo e temperatura personalizzabili.



Soft cooker

Apparecchio per cottura sottovuoto
Sous-Vide-Garer
Thermoplongeur
Máquina para cocinar al vacío

| art. | cm. | Kg. | kW | € |
|----------|--------------|-----|-----|----------|
| 49851-10 | 16,4x22x41,5 | 8 | 0,2 | 2.468,08 |

Stainless steel structure. Suitable for containers up to 60 liters. Min. height of the tank 180 mm, electronic temperature control with 1/10°C precision, adjustable temperature 0>95°C. Pump for water circulation. Acoustic timer. Possibility to memorize up to 20 programs. Level sensor for lack of water.
Struttura in acciaio inox. Per recipienti fino a 60 litri. Altezza minima del recipiente 180 mm, controllo elettronico della temperatura con precisione al 1/10°C, temperatura regolabile 0>95°C. Pompa per la circolazione dell'acqua. Timer acustico. Possibilità di memorizzare fino a 20 programmi. Sensore di livello per mancanza acqua.



Induction cooker TC 3500

Piastra ad induzione
Induktionsplatte
Plaque à induction
Placa de inducción

| art. | cm. | Kg. | kW | € |
|----------|------------|-----|-----|--------|
| 49998-35 | 35,5x46x11 | 5,5 | 3,5 | 723,80 |

Stainless steel body, Schott Ceran surface. Thermocontrol. 12 power levels. Temperature preselection 60-240°C. Timer 23 hours 59 min. – Corpo in acciaio inox, piano Schott Ceran. Thermocontrol. 12 livelli di potenza. Preselezione temperatura 60-240°C. Timer 23 ore 59'.



Induction cooker

Piastra ad induzione
Induktionsplatte
Plaque à induction
Placa de inducción

| art. | cm. | Kg. | kW | € |
|----------|----------|-----|-----|--------|
| 18162-RA | 30x37x10 | 6 | 2,7 | 303,81 |

Stainless steel body, Schott ceran surface. Timer 0-180 min. 10 power levels. Temperature range 60-240°C. – Corpo inox, piano Schott ceran. Timer 0-180 min. 10 livelli di potenza. Temperatura 60-240°C.



**Induction cooker, to be built into counter**

Piastra ad induzione da incasso
Induktionsplatte, thekeneinbau
Plaque à induction encastrable
Placa de inducción para emportar

| art. | cm. | Kg. | kW | € |
|----------|------------|-----|-----|--------|
| 18162-RB | 36X38x12,5 | 5,7 | 3,5 | 501,60 |

Schott ceran surface. Timer 0-180 min. 10 power levels. Temperature range 60-240°C. – Piano Schott ceran. Timer 0-180 min. 10 livelli di potenza. Temperatura 60-240°C.

**Induction cooker, to be built into counter**

Piastra ad induzione da incasso
Induktionsplatte, thekeneinbau
Plaque à induction encastrable
Placa de inducción para emportar

| art. | cm. | Kg. | kW | € |
|----------|-------------|-----|----|--------|
| 49998-20 | 35,5x35,5x6 | 3,4 | 2 | 377,68 |

Schott ceran surface. 5 power levels. Temperature range 60-240°C. – Piano Schott ceran. 5 livelli di potenza. Temperatura 60-240°C.

**Induction station**

Stazione induzione
Induktionsstation
Station d'induction
Estación inducción

| art. | Ø cm. | cm. | V | W | € |
|----------|-------|--------------|---------|-----|--------|
| 49999-04 | 24 | 35,4x32,5x19 | 220-240 | 900 | 354,36 |

Induction plate with temperature regulator 60>140°C. Black metal support, walnut wood insert and stainless steel frame. – Piastra a induzione con regolatore di temperatura 60>140°C. Supporto in metallo nero, inserto in legno di noce e cornice inox.

**Coffee percolator**

Percolatore per caffè
Kaffee-Perkolator
Percolateur à café
Percolator de café

| art. | Ø cm. | h. cm. | lt. | W | € |
|----------|-------|--------|------|------|--------|
| 49846-05 | 28 | 38,5 | 4,5 | 950 | 257,68 |
| 49846-09 | 28 | 38,5 | 9,2 | 950 | 308,74 |
| 49846-15 | 33 | 54,0 | 15,0 | 1650 | 354,36 |

**Samovar PYRAMID**

Samovar
Samovar
Samovar
Samovar

| art. | cm. | lt. | W | € |
|----------|--------------|-------|------|--------|
| 49856-04 | 35,5x30x45,2 | 4+1,2 | 2500 | 471,75 |

Teapot with strainer. Cable length approx. 130 cm. With 2 heating elements 2000W and 500W. – Teiera con colino. Lunghezza cavo circa 130 cm. Con 2 resistenze 2000W e 500W.

**Samovar ROMANOV**

Samovar
Samovar
Samovar
Samovar

| art. | cm. | lt. | W | € |
|----------|----------|-------|------|--------|
| 49855-05 | 34x27x59 | 5+1,3 | 1800 | 924,60 |

Teapot with strainer. Cable length approx. 100 cm. With 2 heating elements 1300W and 500W. – Teiera con colino. Lunghezza cavo circa 100 cm. Con 2 resistenze 1300W e 500W.

SS

SS

SS





SS

Samovar SORAYA

Samovar
Samovar
Samovar
Samovar

| art. | cm. | lt. | W | € |
|----------|--------------|--------|------|---|
| 49855-10 | 35,2x44,5x69 | 10+1,6 | 3000 | - |

Teapot with strainer. Cable length approx. 130 cm. With 2 heating elements 2300W and 700W. – Teiera con colino. Lunghezza cavo circa 130 cm. Con 2 resistenze 2300W e 700W.



SS

Samovar KATHARINA

Samovar
Samovar
Samovar
Samovar

| art. | cm. | lt. | W | € |
|----------|----------------|------|------|----------|
| 49855-15 | 39,5x44,5x74,5 | 15+2 | 3000 | 2.339,84 |

Teapot with strainer. Cable length approx. 130 cm. With 2 heating elements 2300W and 700W. – Teiera con colino. Lunghezza cavo circa 130 cm. Con 2 resistenze 2300W e 700W.



SS

Chocolate fountain

Fontana cioccolato
Schokoladenbrunnen
Fontaine à chocolat
Fuente para chocolate

| art. | Ø cm. | h. cm. | lt. | W | € |
|----------|-------|--------|-----|-----|----------|
| 42982-08 | 38 | 80 | 3,5 | 370 | 1.452,33 |

230V-50Hz-Amps 1,6A. Minimum quantity of chocolate necessary for operation is about 3.5 kg, the maximum is 8 kg. – Quantità minima di cioccolato richiesta per funzionare è di circa 3,5 kg e può contenerne fino a 8 kg.



PP

SS

Soup kettle

Zuppiera
Suppenwärmer
Marmite à soupe
Marmita para sopa

| art. | Ø cm. | h. cm. | lt. | W | € |
|----------|-------|--------|-----|---------|--------|
| 49847-38 | 38 | 36,5 | 10 | 450-550 | 259,89 |



Soup kettle

Zuppiera
Suppenwärmer
Marmite à soupe
Marmita para sopa

| art. | Ø cm. | h. cm. | lt. | W | € |
|----------|-------|--------|-----|-----|--------|
| 49847-08 | 33 | 37 | 10 | 400 | 104,12 |



Raclette maker

Macchina per raclette
Raclette Tischgerät
Appareil à raclette
Máquina raclette

| art. | cm. | V | W | € |
|----------|--------------|-----|-----|--------|
| 42420-06 | 44,5x21,5x30 | 230 | 850 | 431,04 |

Foldable model with transport hook. 2 heating ramps, adjustable height. Suitable for cheese size 1/6 to 1/3 of a wheel. In stainless steel and painted steel. – Modello pieghevole con gancio di trasporto. 2 rampe di riscaldamento, altezza regolabile. Adatto per formaggi da 1/6 a 1/3 di una forma. In acciaio inossidabile e acciaio verniciato.



**Raclette maker**

Macchina per raclette
Raclette Tischgerät
Appareil à raclette
Máquina raclette

| art. | cm. | V | W | € |
|----------|------------|-----|-----|--------|
| 42420-08 | 46x26,5x40 | 230 | 850 | 316,88 |

Tiltable and easily removable cheese holder. Heating block adjustable height. Ideal for 6-8 people, 1/2 shape. Cheese holder in stainless steel and epoxy painted steel structure. – Porta formaggio inclinabile e facilmente rimovibile. Blocco riscaldante regolabile in altezza. Ideale per 6-8 persone, 1/2 forma. Porta formaggio in acciaio inossidabile e struttura in acciaio verniciato epossidico.

**Sugar lamp**

Lampada per zucchero
Zuckerlampe
Lampe à sucre
Lámpara para azúcar

| art. | cm. | Kg. | € |
|----------|----------|-----|--------|
| 47840-11 | 61x41x50 | 6,4 | 631,54 |

Stainless steel. Infrared lamp, 3 selection powers 500-1000-1500W. Cable included. – Acciaio inox. Lampada infrarossi con 3 potenze selezionabili, 500-1000-1500W. Incl. cavo di alimentazione.



ABS

Tempering unit

Temperatrice
Temperiergerät
Tempéreuse
Templadora

| art. | Ø cm. | h. cm. | lt. | € |
|----------|-------|--------|-----|--------|
| 47698-01 | 20,5 | 21,2 | 1,7 | 572,25 |

For ice cream parlours, ideal for chocolate coatings of ice creams on sticks. Can be used straight on the counter. Removable anodized aluminum tank. – Per gelaterie, ideale per coperture in cioccolato di gelati e semifreddi su stecco. Può essere utilizzato direttamente sul banco. Vasca estraibile in alluminio anodizzato.

**Raclette maker, 4 pans**

Macchina per raclette, 4 padelle
Raclette Tischgerät, 4 Pfannen
Appareil à raclette, 4 poêlons
Máquina raclette

| art. | cm. | W | € |
|----------|----------|-----|--------|
| 41318-00 | 51x10x12 | 600 | 211,35 |

Non-stick upper plate for all cooking (vegetables, meats, etc.).

Piastra superiore antiaderente per tutte le cotture (verdure, carne, ecc.).

**Spray gun**

Pistola
Sprühpistole
Pistolet
Pistola

| art. | ml. | Kg. | W | rpm | € |
|----------|-----|-----|----|-----|--------|
| 47848-07 | 700 | 1,1 | 60 | 280 | 676,26 |

Usable for hot liquids max. 65 °C. Equipped with nozzle 0,6 mm.
Per liquidi caldi max. 65°C. Bocchetta in dotazione da 0,6 mm.



ABS

Tempering unit

Temperatrice
Temperiergerät
Tempéreuse
Templadora

| art. | Ø cm. | h. cm. | lt. | € |
|----------|-------|--------|-----|--------|
| 47698-02 | 26 | 16 | 1,8 | 314,06 |

Mini dry melter, allows to process tiny chocolate quantities without any waste. Practical removable tank. – Mini scioglitori a secco, adatto per piccole produzioni senza sprechi. Pratica vasca estraibile.





SS
ABS

Tempering unit

Temperatrice
Temperiergerät
Tempéreuse
Templadora

| art. | cm. | lt. | € |
|----------|------------|-----|--------|
| 47698-03 | 40x24x13,5 | 3,6 | 639,78 |
| 47698-06 | 40x33x13,5 | 6,0 | 761,49 |

Analog tempering units. Housing made with heat-resistant plastic. Removable stainless steel tank. UK/US/JAPAN/AUSTRALIA/CHINA wirings upon request.
Temperatrici analogiche. In materiale plastico termoresistente. Vasca inox removibile. Su richiesta cablaggio GB/USA/GIAPPONE/AUSTRALIA/CINA.



SS
ABS

Tempering unit, digital

Temperatrice digitale
Temperiergerät, digital
Tempéreuse digitale
Templadora digital

| art. | cm. | lt. | € |
|----------|------------|-----|----------|
| 47698-07 | 40x33x13,5 | 6,0 | 1.045,00 |

Made of heat-resistant plastic material, stainless steel tank and lid, thermal probe for chocolate temperature control. Tempering manually adjustable or following the 3 programs depending on the type of chocolate: white, milk and dark. – In materiale plastico termoresistente, vasca e coperchio in acciaio inox, sonda termica per la regolazione della temperatura del cioccolato. Temperaggio regolabile manualmente o seguendo i 3 programmi in base al tipo di cioccolato: bianco, al latte e fondente.



Airbrush compressor

Compressore per penna aerografa
Airbrush Kompressor
Compresseur
Compresor

| art. | cm. | W | € |
|----------|----------|-----|--------|
| 47844-06 | 16x30x23 | 200 | 392,55 |

Cap. 4 bar.



Caramelizer

Caramellizzatore
Caramelisateur
Carameliseur
Quemador

| art. | Ø cm. | W | € |
|----------|-------|------|--------|
| 47847-10 | 10 | 0,65 | 266,53 |



Caramelizer

Caramellizzatore
Caramelisateur
Carameliseur
Quemador

| art. | l. cm. | W | € |
|----------|--------|-----|--------|
| 47847-23 | 23 | 1,5 | 200,20 |



Meat mincer

Tritacarne
Fleischwolf
Hachoir
Picadora de carne

| art. | cm. | Kg. | kW | € |
|----------|----------|-----|------|--------|
| 49921-00 | 18x42x43 | 6 | 0,35 | 495,57 |



**Gravity slicing machine**

Affettatrice a gravità

Schräg Aufschnittmaschine

Trancheuse à gravité

Cortadora de gravedad

| art. | Ø cm. | cm. | Kg. | rpm | € |
|-----------|-------|------------|-----|-----|--------|
| 49975-19 | 19,5 | 52x36x31,5 | 10 | 300 | 890,63 |
| 49975U19* | 19,5 | 52x36x31,5 | 10 | 300 | 717,37 |

*Extra CE. Built-in blade sharpener. – Extra CE. Affilatoio fisso.

**Gravity slicing machine**

Affettatrice a gravità

Schräg Aufschnittmaschine

Trancheuse à gravité

Cortadora de gravedad

| art. | Ø cm. | cm. | Kg. | rpm | € |
|-----------|-------|------------|------|-----|----------|
| 49975-25 | 25 | 62x42,5x37 | 15,5 | 300 | 1.253,54 |
| 49975U25* | 25 | 62x42,5x37 | 15,5 | 300 | 1.018,27 |

*Extra CE. Built-in blade sharpener. – Extra CE. Affilatoio fisso.

**Gravity slicing machine**

Affettatrice a gravità

Schräg Aufschnittmaschine

Trancheuse à gravité

Cortadora de gravedad

| art. | Ø cm. | cm. | Kg. | rpm | € |
|-----------|-------|------------|-----|-----|----------|
| 49975-22 | 22 | 58x40,5x34 | 10 | 300 | 1.048,52 |
| 49975U22* | 22 | 58x40,5x34 | 10 | 300 | 833,45 |

*Extra CE. Built-in blade sharpener. – Extra CE. Affilatoio fisso.

**Gravity slicing machine**

Affettatrice a gravità

Schräg Aufschnittmaschine

Trancheuse à gravité

Cortadora de gravedad

| art. | Ø cm. | cm. | Kg. | rpm | € |
|-----------|-------|------------|-----|-----|----------|
| 49975-30 | 30 | 65x49,5x44 | 23 | 300 | 1.828,20 |
| 49975U30* | 30 | 65x49,5x44 | 23 | 300 | 1.441,77 |

*Extra CE. Built-in blade sharpener. – Extra CE. Affilatoio fisso.

**Gravity slicing machine**

Affettatrice a gravità

Schräg Aufschnittmaschine

Trancheuse à gravité

Cortadora de gravedad

| art. | Ø cm. | cm. | Kg. | rpm | € |
|-----------|-------|------------|-----|-----|----------|
| 49975-35 | 35 | 89x58,5x48 | 36 | 260 | 2.967,56 |
| 49975U35* | 35 | 89x58,5x48 | 36 | 260 | 2.570,99 |

*Extra CE. Built-in blade sharpener. – Extra CE. Affilatoio fisso.

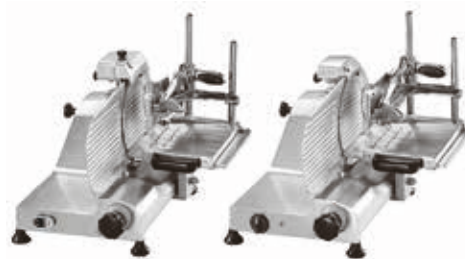
**Vertical slicing machine**

Affettatrice verticale

Vertikal Aufschnittmaschine

Trancheuse verticale

Cortadora vertical

| art. | Ø cm. | cm. | Kg. | rpm | € |
|-----------|-------|----------|-----|-----|----------|
| 49974-25 | 25 | 53x52x50 | 24 | 300 | 2.140,75 |
| 49974U25* | 25 | 53x52x50 | 24 | 300 | 1.804,68 |

*Extra CE. – Extra CE.





Vertical slicing machine
Affettatrice verticale
Vertikal Aufschnittmaschine
Trancheuse verticale
Cortadora vertical

| art. | Ø cm. | cm. | Kg. | rpm | € |
|-----------|-------|----------|-----|-----|----------|
| 49974-30 | 30 | 53x52x50 | 27 | 300 | 2.248,29 |
| 49974U30* | 30 | 53x52x50 | 27 | 300 | 1.992,92 |

*Extra CE. – Extra CE.



Sieve
Passaverdura
Passiergerät
Moulin
Molino

| art. | Ø cm. | h. cm. | kg./H | Kg. | W | € |
|----------|-------|--------|-------|------|-----|----------|
| 49879-37 | 37 | 108 | 300 | 23,5 | 600 | 3.879,60 |

Threephase motor 380V. Disc 3 mm. – Motore trifase 380V. Griglia 3 mm.

SS



Can opener
Apriscatole
Dosenöffner
Ouvre-boîte
Abrelatas

| art. | cm. | Kg. | € |
|----------|----------|-----|----------|
| 49814-00 | 44x25x75 | 13 | 2.973,69 |

Dual speed motor. Opens all can shapes from 50 to 270 mm height.
Motore a 2 velocità. Per formati scatola da 50 a 270 mm di altezza.

SS



Knife sterilizer
Sterilizzatore per coltelli
Messertentkeimer
Armoire de sterilisation
Esterilizador para cuchillos

| art. | cm. | W | € |
|----------|------------|----|----------|
| 49871-10 | 57,5x17x60 | 15 | 970,53 |
| 49871-20 | 103x17x60 | 30 | 1.595,24 |

Plexiglas door, magnetic lock. Timer setting from 0 up to 2 hours. Door with stop device when opening. Protection IP 24. – Porta in plexiglas, chiusura magnetica. Programmabile da 0 a 2 ore. Dispositivo d'arresto all'apertura porta. Indice di protezione IP 24.

SS



Knife sharpener
Affilacoltelli
Messerschleifapparat
Aiguiseur
Afilador

| art. | cm. | Kg. | W | rpm | € |
|----------|----------|-----|-----|------|----------|
| 49872-00 | 25x10x12 | 4 | 172 | 1550 | 1.749,60 |

ABS knife guide. Pressure sensitive motor shuts down automatically.
Guida in ABS estraibile. Motore con dispositivo autobloccante.

Etlund



Knife sharpener
Affilacoltelli
Messerschleifapparat
Aiguiseur
Afilador

| art. | cm. | Kg. | € |
|----------|----------|-----|----------|
| 49741-15 | 23x33x16 | 6,4 | 1.980,65 |
| 49741-07 | 23x16x16 | 4,6 | 1.087,01 |



CUCINA SENZA GLUTINE

FOR GLUTEN-FREE COOKING



UNA LINEA COMPLETA DI ARTICOLI E STRUMENTI PROFESSIONALI FACILMENTE IDENTIFICABILI PER:

- diminuire il rischio di accidentali contaminazioni crociate degli alimenti;
- facilitare il professionista nell'operare e nell'offrire un servizio a favore del cliente con intolleranza al glutine;
- sensibilizzare il settore sul tema "gluten free" di fronte alle nuove esigenze dei consumatori.

A FULL LINE OF HORECA TOOLS AND ITEMS, EASY TO IDENTIFY, AIMED AT:

- reducing the risk of accidental food cross-contamination;
- making it easier for professionals to work and to provide services to clients with gluten intolerance;
- raising awareness on the gluten-free diet issue in the industry so as to respond to the new needs of consumers.



Frypan
Padella

| art. | Ø cm. | € |
|----------|-------|-------|
| 11014F20 | 20 | 65,73 |
| 11014F24 | 24 | 75,88 |
| 11014F28 | 28 | 87,33 |
| 11014F32 | 32 | 97,08 |



Cover
Coperchio

| art. | Ø cm. | € |
|----------|-------|-------|
| 11161F16 | 16 | 22,61 |
| 11161F20 | 20 | 27,14 |
| 11161F24 | 24 | 29,75 |
| 11161F28 | 28 | 33,06 |



Baking sheet alusteel
Teglia forno, acciaio alluminato

| art. | Ø cm. | € |
|----------|-------|------|
| 11739F20 | 20 | 5,63 |
| 11739F24 | 24 | 6,43 |
| 11739F28 | 28 | 8,54 |
| 11739F32 | 32 | 9,65 |



Strainer with hook
Colapasta con manico e gancio

| art. | Ø cm. | € |
|----------|-------|-------|
| 11924F20 | 20 | 56,18 |



Conical colander
Colapasta tronco conico

| art. | Ø cm. | € |
|----------|-------|-------|
| 11930F24 | 24 | 88,24 |





One piece ladle
Mestolo unipezzo

| art. | Ø cm. | € |
|----------|-------|-------|
| 11970F06 | 6,5 | 13,17 |
| 11970F08 | 8,0 | 14,27 |
| 11970F10 | 10 | 18,39 |



One piece skimmer
Schiumarola unipezzo

| art. | Ø cm. | € |
|----------|-------|-------|
| 11971F10 | 10 | 14,07 |
| 11971F12 | 12 | 17,39 |



One piece perforated spatula
Paletta forata unipezzo

| art. | Ø cm. | € |
|----------|-------|-------|
| 11973F10 | 10 | 17,09 |
| 11973F12 | 12 | 18,69 |



One piece basting spoon
Cucchiaione unipezzo

| art. | € |
|----------|-------|
| 11982F38 | 17,39 |



Stock pot
Pentola alta

| art. | Ø cm. | € |
|----------|-------|--------|
| 12001F20 | 20 | 85,32 |
| 12001F24 | 24 | 95,68 |
| 12001F28 | 28 | 125,12 |



Saucepot 2 handles
Casseruola alta 2 maniglie

| art. | Ø cm. | € |
|----------|-------|--------|
| 12007F16 | 16 | 67,84 |
| 12007F24 | 24 | 84,62 |
| 12007F28 | 28 | 107,13 |



Colander for low stock pot
Colapasta per pentola bassa

| art. | Ø cm. | € |
|----------|-------|--------|
| 12123F20 | 20 | 115,68 |
| 12123F24 | 24 | - |
| 12123F28 | 28 | - |



Wire whip, 8 wires
Frusta 8 fili

| art. | l. cm. | € |
|----------|--------|-------|
| 12928F30 | 30 | 15,78 |
| 12928F35 | 35 | 19,30 |



Egg whisk, 11 wires
Frusta 11 fili



| art. | l. cm. | € |
|----------|--------|-------|
| 12929F30 | 30 | 15,78 |
| 12929F35 | 35 | 17,39 |

Gastronorm Container
Bacinella gastronorm



| art. | GN | dim. cm. | € |
|----------|-----|-------------|-------|
| 14102F02 | 1/1 | 53x32,5x2 | 22,31 |
| 14102F04 | 1/1 | 53x32,5x4 | 26,23 |
| 14102F06 | 1/1 | 53x32,5x6,5 | 31,66 |
| 14102F10 | 1/1 | 53x32,5x10 | 36,78 |
| 14102F15 | 1/1 | 53x32,5x15 | 52,06 |
| 14102F20 | 1/1 | 53x32,5x20 | 63,01 |
| 14103F02 | 2/3 | 35,3x32x2 | 15,58 |
| 14103F04 | 2/3 | 35,3x32x4 | 20,70 |
| 14103F06 | 2/3 | 35,3x32x6,5 | 23,62 |
| 14103F10 | 2/3 | 35,3x32x10 | 28,94 |
| 14103F15 | 2/3 | 35,3x32x15 | 37,69 |
| 14103F20 | 2/3 | 35,3x32x20 | 44,02 |
| 14104F06 | 2/4 | 53x16,2x6,5 | 24,32 |
| 14104F10 | 2/4 | 53x16,2x10 | 30,15 |
| 14104F15 | 2/4 | 53x16,2x15 | 39,90 |
| 14105F02 | 1/2 | 32x26,5x2 | 13,57 |
| 14105F04 | 1/2 | 32x26,5x4 | 15,48 |
| 14105F06 | 1/2 | 32x26,5x6,5 | 19,10 |
| 14105F10 | 1/2 | 32x26,5x10 | 23,32 |
| 14105F15 | 1/2 | 32x26,5x15 | 30,85 |
| 14105F20 | 1/2 | 32x26,5x20 | 37,39 |
| 14107F06 | 1/3 | 32,5x18x6,5 | 15,08 |
| 14107F10 | 1/3 | 32,5x18x10 | 17,69 |
| 14107F15 | 1/3 | 32,5x18x15 | 23,52 |
| 14107F20 | 1/3 | 32,5x18x20 | 28,04 |
| 14108F06 | 1/4 | 26,5x16x6,5 | 12,96 |
| 14108F10 | 1/4 | 26,5x16x10 | 15,88 |
| 14108F15 | 1/4 | 26,5x16x15 | 19,50 |
| 14108F20 | 1/4 | 26,5x16x20 | 28,24 |
| 14109F06 | 1/6 | 17,6x16x6,5 | 11,36 |
| 14109F10 | 1/6 | 17,6x16x10 | 12,76 |
| 14109F15 | 1/6 | 17,6x16x15 | 17,09 |
| 14109F20 | 1/6 | 17,6x16x20 | 31,86 |
| 14110F06 | 1/9 | 17,6x11x6,5 | 11,86 |
| 14110F10 | 1/9 | 17,6x11x10 | 15,28 |

Gastronorm cover
Coperchio gastronorm



| art. | GN | € |
|----------|-----|-------|
| 14502F00 | 1/1 | 21,11 |
| 14503F00 | 2/3 | 16,08 |
| 14504F00 | 2/4 | 16,48 |
| 14505F00 | 1/2 | 12,66 |
| 14507F00 | 1/3 | 9,75 |
| 14508F00 | 1/4 | 8,34 |
| 14509F00 | 1/6 | 7,04 |
| 14510F00 | 1/9 | 6,03 |



GN-lids
GN coperchi



| art. | GN | dim. cm. | € |
|----------|-----|-----------|------|
| 14922-77 | 1/1 | 53x3,25 | 7,14 |
| 14925-77 | 1/2 | 32,5x26,5 | 3,72 |
| 14927-77 | 1/3 | 32,5x17,5 | 3,12 |
| 14928-77 | 1/4 | 26,4x16,2 | 3,72 |
| 14929-77 | 1/6 | 17,6x16,2 | 2,51 |
| 14930-77 | 1/9 | 17,6x10,8 | 2,41 |



GN-containers
GN bacinelle



| art. | GN | dim. cm. | lt. | € |
|----------|-----|--------------|------|-------|
| 15101-10 | 1/1 | 53x32,5x10 | 13,3 | 15,08 |
| 15105-10 | 1/2 | 32,5x26,5x10 | 6,1 | 8,44 |
| 15107-10 | 1/3 | 32,5x17,5x10 | 3,8 | 7,14 |
| 15108-10 | 1/4 | 26,4x16,2x10 | 2,6 | 5,93 |
| 15109-10 | 1/6 | 17,6x16,2x10 | 1,6 | 5,23 |
| 15110-10 | 1/9 | 17,6x10,8x10 | 0,9 | 4,32 |



Bread knife
Coltello pane



| art. | l. cm. | € |
|----------|--------|-------|
| 18028F21 | 21 | 16,08 |
| 18028F25 | 25 | 22,61 |
| 18028F30 | 30 | 25,02 |
| 18028F36 | 36 | 30,45 |



Pizza wheel
Rotella tagliapizza



| art. | Ø cm. | € |
|----------|-------|-------|
| 18324F10 | 10 | 11,26 |



Spatula perforated
Spatola pasticcio e pizza forata



| art. | € |
|----------|------|
| 18510F07 | 8,94 |



Pizza turner
Spatola per pasticcio e pizza



| art. | € |
|----------|-------|
| 18511F15 | 11,66 |



Pastry spatula
Spatola per dolci



| art. | € |
|----------|------|
| 18513F14 | 6,33 |



Perforated pizza peel, aluminum
Pala pizza forata, alluminio



| art. | Ø cm. | dim. cm. | l. cm. | € |
|----------|-------|----------|--------|--------|
| 41704G33 | - | 33x33 | 150 | 172,86 |
| 41704G36 | - | 36x36 | 150 | 196,78 |



Perforated pizza peel, small
Palettino pizza forato



| art. | Ø cm. | dim. cm. | l. cm. | € |
|----------|-------|----------|--------|--------|
| 41737G20 | 20 | - | 150 | 133,36 |
| 41737G23 | 23 | - | 150 | 138,09 |



Adjustable brush
Spazzola orientabile



| art. | Ø cm. | dim. cm. | l. cm. | € |
|----------|-------|----------|--------|--------|
| 41767G20 | - | 20x6 | 160 | 112,26 |



Baking sheet alusteel
Teglia rettangolare, alluminata



| art. | dim. cm. | € |
|----------|----------|-------|
| 41751F30 | 30x23x3 | 16,88 |
| 41751F40 | 40x30x3 | 20,10 |
| 41751F60 | 60x40x3 | 27,64 |



Cutting board
Tagliere



| art. | GN | dim. cm. | col. | € |
|----------|-----|-----------|------|-------|
| 42522-07 | - | 32x26,5x2 | ● | 23,01 |
| 42538-07 | 1/1 | 53x32,5x2 | ● | 51,26 |
| 42539-07 | - | 60x40x2 | ● | 68,54 |



Cutting board
Tagliere



| art. | GN | dim. cm. | col. | € |
|----------|-----|-----------|------|-------|
| 42522F09 | 1/2 | 32x26,5x2 | ● | 24,12 |
| 42538F09 | 1/1 | 53x32,5x2 | ● | 51,96 |
| 42539F09 | - | 60x40x2 | ● | 69,55 |



Labels 14 allergens
Etichette 14 allergeni



| art. | dim. cm. | Pcs/Pz | € |
|----------|----------|--------|-------|
| 44630-02 | 7,5x4 | 500 | 20,20 |



Labels Allergens
Etichette allergeni



| art. | dim. cm. | Pcs/Pz | € |
|----------|----------|--------|-------|
| 44630-06 | 7x4,5 | 500 | 20,30 |



Delivery labels with allergens
Etichette delivery con allergeni



| art. | dim. cm. | Pcs/Pz | € |
|----------|----------|--------|-------|
| 44630-07 | 14x4,5 | 250 | 28,94 |

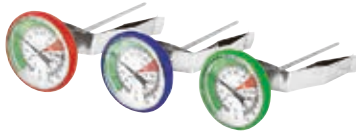

Milk frothing thermometers, 3 pcs
Termometri latte/barista, 3 pz



| art. | Ø cm. | -10+110°C | 1°C | € |
|----------|-------|-----------|-----|-------|
| 49709-03 | 4,5 | -10+110°C | 1°C | 26,33 |



Digital thermometer
Termometro digitale



| art. | -49,9>299,9°C | 0,1/1°C | € |
|----------|---------------|---------|--------|
| 49880-17 | -49,9>299,9°C | 0,1/1°C | 111,76 |



Bread tongs
Molla pane



| art. | l. cm. | € |
|----------|--------|-------|
| 52550F63 | 23 | 20,70 |



Spaghetti tongs
Molla spaghetti



| art. | l. cm. | € |
|----------|--------|-------|
| 52550F73 | 21 | 16,18 |



Toast-pastry tongs
Molla toast-dolci



| art. | l. cm. | € |
|----------|--------|-------|
| 52550F78 | 24 | 19,50 |



Cake pliers
Pinza torta



| art. | l. cm. | € |
|----------|--------|-------|
| 52550F80 | 28 | 30,75 |



Pastry pliers
Pinza dolci



| art. | l. cm. | € |
|----------|--------|-------|
| 52550F88 | 18 | 21,71 |



Tap/Rubinetto : For/Per # 11102

| art. | € |
|----------|--------|
| 11102-99 | 183,92 |



Roasting pan grid/Griglia brasiera : For/Per # 11965

| art. | dim. cm. | € |
|----------|----------|--------|
| 11966-50 | 50x30 | 116,78 |
| 11966-60 | 60x35 | 125,63 |
| 11966-61 | 61x43 | 136,08 |



Clutch left, Asia rectangular/Frizione sx Asia rettangolare

| art. | € |
|----------|--------|
| 18132-KP | 119,49 |



Clutch right, Asia rectangular/Frizione dx Asia rettangolare

| art. | € |
|----------|--------|
| 18132-KQ | 112,36 |



Clutch right Asia/Frizione dx Asia

| art. | Ø cm. | € |
|----------|-------|-------|
| 18136-KQ | 33-40 | 50,95 |

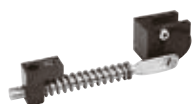

Clutch left, Asia/Frizione sx Asia

| art. | Ø cm. | € |
|----------|-------|--------|
| 18136-KP | 33 | 111,25 |
| 18136-KR | 40 | 119,49 |



Clutch spring for rect. ABS, long side opening/Frizione molla ABS rett., apertura lato lungo

| art. | € |
|----------|--------|
| 18162-AF | 196,68 |



Clutch spring for rect. ABS, short side opening/Frizione molla ABS rett., apertura lato corto

| art. | € |
|----------|--------|
| 18162-AG | 200,50 |



Spare parts/Ricambi : For/Per # 18166A

| art. | des | Ø cm. | € |
|----------|-----------------|-------|--------|
| 18166-AD | Clutch/Frizione | 24 | 110,15 |
| 18166-AE | Clutch/Frizione | 36 | 110,45 |
| 18166-AF | Clutch/Frizione | 40 | 110,55 |
| 18166-AH | Clutch/Frizione | 30 | 109,44 |



Spare parts/Ricambi : For/Per # 18172A54

| art. | des | € |
|----------|------------------------------|--------|
| 18172-AF | Clutch spring/Frizione molla | 190,65 |



Spare parts/Ricambi : For/Per # 18172A56

| art. | des | € |
|----------|------------------------------|--------|
| 18172-AG | Clutch spring/Frizione molla | 195,27 |

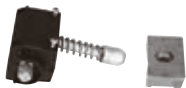

Spare parts/Ricambi : For/Per # 18176A

| art. | des | € |
|----------|---|--------|
| 18176-AE | Clutch for ABS Ø cm 36/Frizione ABS Ø cm 36 | 107,43 |
| 18176-AF | Clutch for ABS Ø cm 40/Frizione ABS Ø cm 40 | 107,54 |
| 18176-AH | Clutch for ABS Ø cm 30/Frizione ABS Ø cm 30 | 106,43 |



Cutlery bag

Borsa porta coltelli

| art. | € |
|----------|-------|
| 18190-AA | 84,32 |



Spare parts/Ricambi : For/Per # 18353-17

| art. | des | € |
|----------|------------------------------------|-------|
| 18353-AA | Juice container/Contenitore succhi | 62,01 |
| 18353-BB | Tap/Rubinetto | 86,93 |
| 18353-CA | Lid/Coperchio | 73,67 |
| 18353-DB | Drip bowl/Ciotola raccogli gocce | 16,68 |
| 18353-VA | Eutectic pad/Contenitore eutettico | 4,32 |



Spare parts/Ricambi : For/Per # 19810-00

| art. | des | € |
|----------|--------------------|------|
| 19810-AA | Blade/Lama | 4,42 |
| 19810-AB | Gear/Ruota dentata | 9,65 |

Spare porcelain/Ricambio porcellana : For/Per # 41311-00

| art. | € |
|----------|-------|
| 41311-AA | 24,42 |

Folding lid/Coperchio a ribalta

| art. | Ø cm. | € |
|----------|-------|-------|
| 41400-AB | 23,5 | 21,61 |
| 41405-AB | 13,5 | 20,20 |

Cereal-bar glass/Barattolo cereali, vetro : For/Per # 42460-43; 42470-43

| art. | lt. | € |
|----------|-----|-------|
| 41402-AA | 2 | 14,07 |

Euthetic pad/Eutettico : For/Per # 41448

| art. | Ø cm. | h. cm. | € |
|----------|-------|--------|------|
| 41443-AE | 10,5 | 2 | 6,73 |

Stoppers/Tappi pompa : For/Per # 41500-00

| art. | Pcs/Pz | € |
|----------|--------|------|
| 41500-AA | 2 | 4,22 |

China cup/Porcellana : For/Per # 41563-07

| art. | € |
|----------|-------|
| 41563-AA | 14,07 |

China cup/Porcellana : For/Per # 41564-07,

| art. | € |
|----------|-------|
| 41564-AA | 15,58 |

Cheese jar/Vetro formaggiera : For/Per # 41638-01

| art. | Ø cm. | € |
|----------|-------|-------|
| 41638-91 | 10,5 | 10,85 |

Spare parts/Ricambi : For/Per # 41638-02-04-12-13

| art. | des | Ø cm. | h. cm. | lt. | € |
|----------|--|-------|--------|-----|-------|
| 41638-92 | Oil/Winegar bottle/Ampolla olio/acetato | 6 | 18,5 | 0,2 | 12,96 |
| 41638-93 | Salt shaker/Spargisale - Holes/Fori 6 Ø Mm 1,85 | 4 | 9 | | 6,83 |
| 41638-94 | Pepper shaker/Spargipepe - Holes/Fori 18 Ø Mm 1,35 | 4 | 9 | | 6,83 |
| 41638-95 | Toothpick holder/Porta stecchi | 4 | 9 | | 6,83 |



Brush/Spazzola : For/Per # 41767-20

| art. | € |
|----------|-------|
| 41767-AA | 44,52 |



Eutectic pad/Eutettico tondo

| art. | Ø cm. | h. cm. | € |
|----------|-------|--------|-------|
| 41910-AL | 15 | 2,5 | 17,79 |



Cover/Tappo : For/Per # 42401

| art. | € |
|----------|------|
| 42401-AA | 3,42 |



Cover/Tappo : For/Per # 42505

| art. | € |
|----------|------|
| 42405-AA | 2,21 |



Set 10 blades/Set 10 lame : For/Per # 42520-00

| art. | € |
|----------|--------|
| 42520-AA | 103,72 |



Spare parts/Ricambi : For/Per # 42570-32

| art. | des | mm. | € |
|----------|------------------|-----|--------|
| 42570-91 | Disc/Griglia | 1,5 | 14,67 |
| 42570-92 | Disc/Griglia | 2,5 | 14,67 |
| 42570-94 | Disc/Griglia | 4,0 | 14,67 |
| 42570-99 | Cranck/Manovella | | 105,32 |



Spare parts/Ricambi : For/Per # 42573-31

| art. | des | mm. | € |
|----------|------------------|-----|-------|
| 42573-91 | Disc/Griglia | 1,5 | 11,46 |
| 42573-92 | Disc/Griglia | 2,5 | 11,46 |
| 42573-94 | Disc/Griglia | 4,0 | 11,46 |
| 42573-99 | Cranck/Manovella | | 62,81 |

Spare parts/Ricambi : For/Per # 42574-37

| art. | des | mm. | € |
|----------|------------------|-----|--------|
| 42574-90 | Disc/Griglia | 1,0 | 154,27 |
| 42574-91 | Disc/Griglia | 1,5 | 154,27 |
| 42574-92 | Disc/Griglia | 2,0 | 154,27 |
| 42574-93 | Disc/Griglia | 3,0 | 154,27 |
| 42574-94 | Disc/Griglia | 4,0 | 154,27 |
| 42574-99 | Cranck/Manovella | | 233,86 |

Spare parts/Ricambi : For/Per # 42575-37

| art. | des | mm. | € |
|----------|------------------|-----|--------|
| 42575-90 | Disc/Griglia | 1,0 | 136,28 |
| 42575-91 | Disc/Griglia | 1,5 | 136,28 |
| 42575-92 | Disc/Griglia | 2,0 | 136,28 |
| 42575-93 | Disc/Griglia | 3,0 | 136,28 |
| 42575-94 | Disc/Griglia | 4,0 | 136,28 |
| 42575-99 | Cranck/Manovella | | 215,17 |

Spare parts/Ricambi : For/Per # 42577-39

| art. | des | mm. | € |
|----------|------------------|-----|--------|
| 42577-90 | Disc/Griglia | 1,0 | 146,63 |
| 42577-91 | Disc/Griglia | 1,5 | 146,63 |
| 42577-92 | Disc/Griglia | 2,0 | 146,63 |
| 42577-93 | Disc/Griglia | 3,0 | 146,63 |
| 42577-94 | Disc/Griglia | 4,0 | 146,63 |
| 42577-99 | Cranck/Manovella | | 372,45 |

Glass/Vetro : For/Per # 42939-15

| art. | € |
|----------|------|
| 42939-AA | 4,12 |

Wheel/Ruota : For/Per # 44023-00 # 44024-00

| art. | € |
|----------|-------|
| 44023-AA | 26,93 |

Dish separation grid /Griglia divisoria : For/Per # 44027-00

| art. | € |
|----------|-------|
| 44027-AA | 69,85 |



Eutectic pad/Piastra eutettica : For/Per # 44094R00

| art. | des | dim. cm. | € |
|----------|-------------|-----------|-------|
| 44094-RE | Temp. -32°C | 13X23X3,5 | 46,83 |



Sponge/Spugna : For/Per # 44101-03

| art. | € |
|----------|------|
| 44101-AA | 0,50 |



Container/Contentitore : For/Per # 44103

| art. | des | € |
|----------|---------|------|
| 44103-AA | 3 comp. | 2,01 |
| 44103-AB | 4 comp. | 2,01 |
| 44103-AC | 6 comp. | 1,51 |



Flat mop/Frangia mop : For/Per # 44160-03

| art. | € |
|----------|-------|
| 44160-AA | 39,30 |



Trolley bags/Sacchi carrello : For/Per # 44174-24

| art. | € |
|----------|-------|
| 44174-AA | 65,33 |



Cream puff nozzle/Beccuccio riempi bigné : For/Per # 47612-01

| art. | € |
|----------|---|
| 47612-AA | - |



Knife insert/Inserto porta coltelli : For/Per # 48040-00 - 48040-10

| art. | € |
|----------|-------|
| 48040-AA | 97,79 |



Bone-saw blade/Lama per sega : For/Per # 48231

| art. | mm. | € |
|----------|-----|-------|
| 48232-40 | 400 | 10,85 |
| 48232-45 | 450 | 11,46 |
| 48232-50 | 500 | 11,66 |

Spare parts/Ricambi : For/Per # 49811-00



| art. | des | € |
|----------|----------------------------|-------|
| 49811-01 | Cutting knife kit/Kit lama | 85,53 |
| 49811-02 | Blade/Lama | 28,24 |

Spare parts/Ricambi : For/Per # 49812-00



| art. | des | € |
|----------|--------------------------------------|-------|
| 49812-01 | Blade and wheel/Lama e ruota dentata | 88,84 |
| 49811-02 | Blade/Lama | 28,24 |

Spare parts/Ricambi : For/Per # 49814-00



| art. | des | € |
|----------|--------------------------------------|--------|
| 49811-02 | Blade/Lama | 28,24 |
| 49814-01 | Blade and wheel/Lama e ruota dentata | 150,25 |

Spare parts/Ricambi : For/Per # 49818-00



| art. | des | Ø cm. | € |
|----------|-------------------|-------|--------|
| 49818-AC | Blade/Lama | 7,4 | 199,59 |
| 49818-AD | Pusher/Pressatore | 7,4 | 162,81 |
| 49818-AE | Blade/Lama | 10,2 | 194,47 |
| 49818-AF | Pusher/Pressatore | 10,2 | 170,35 |

Set 7 blades/Set 7 lame : For/Per # 49829-11



| art. | € |
|----------|-------|
| 49829-BA | 17,99 |

Spare parts/Ricambi : For/Per # 49830-60



| art. | des | € |
|----------|------------------------------|--------|
| 49830-00 | Slicer/Mandolino | 282,81 |
| 49830-02 | Protective carriage/Carrello | 74,77 |
| 49830-AA | 38 Blades/Pettine 38 lame | 84,52 |
| 49830-AB | 44 Blades/Pettine 44 lame | 91,66 |
| 49830-AC | 60 Blades/Pettine 60 lame | 102,91 |

Spare parts/Ricambi : For/Per # 49832-10



| art. | des | mm. | € |
|----------|-------------------|-----|-------|
| 49832-80 | Pusher/Pressatore | 10 | 20,60 |
| 49832-86 | Pusher/Pressatore | 6 | 20,60 |
| 49832-88 | Pusher/Pressatore | 8 | 20,60 |
| 49832-90 | Blade/Lama | 10 | 58,99 |
| 49832-96 | Blade/Lama | 6 | 58,99 |
| 49832-98 | Blade/Lama | 8 | 58,99 |

Spare parts/Ricambi : For/Per # 49834-00



| art. | des | € |
|----------|------------------------------|-------|
| 49834-01 | Peeling blade/Lama a pelare | 70,45 |
| 49834-02 | Slicing blade/Lama affettare | 63,52 |



Blade assembly/Set lame : For/Per # 49837-05

| art. | € |
|----------|-------|
| 49837-AA | 92,96 |



Blade assembly/Set lame : For/Per # 49838-08

| art. | € |
|----------|--------|
| 49838-AB | 125,42 |



Disc/Griglia : For/Per # 49879-37

| art. | mm. | € |
|----------|-----|--------|
| 49879-90 | 1,0 | 165,42 |
| 49879-91 | 1,5 | 165,42 |
| 49879-92 | 2,0 | 165,42 |
| 49879-93 | 3,0 | 165,42 |
| 49879-94 | 4,0 | 165,42 |

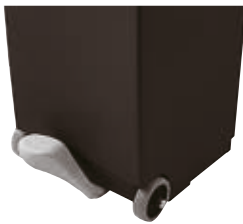

Pedal & opening assembly/Pedaliere e movimento : For/Per # 49899-01

| art. | € |
|----------|-------|
| 49899-AA | 73,67 |



Glass/Bicchieri : For/Per # 49956-01

| art. | € |
|----------|--------|
| 49956-AA | 128,64 |



Display for fry pans/Espositore per padelle ferro

| art. | € |
|--------|--------|
| XO1046 | 186,33 |

ALPHABETICAL INDEX

INDICE ALFABETICO

| | | | | | |
|--------------------------|------------------------------|---------------------------------|---------------|-----------------------------------|------------|
| A | | Caviar fork/spoon | 401 | Dunnage rack | 544 |
| Accessories s/steel | 69 | Chafing dishes | 501 | E | |
| Air pot | 388, 500 | Chalkmarker | 317 | Egg basket | 481 |
| Airbrush + compressor | 211 | Champagne saber | 405 | Egg cup | 391 |
| Ananas corer | 109, 137 | Champagne stopper | 357 | Egg rings | 138 |
| Appetizer platters | 367 | Changing table | 538 | Egg separator | 115 |
| Apple corer/peeler | 111, 114, 138 | Cheese jar | 396 | Egg slicer/top cutter | 138 |
| Appolia baking dishes | 438 | Cheese shaker | 397 | Emulsifier | 555 |
| Apron | 185, 353 | Cheese slicer | 108, 112 | Enamelled cast iron cookware | 60 |
| Artichoke corer | 139 | Chef's torch | 212 | Enamelled cast iron mini cookware | 35 |
| Ashtray | 407 | Chinese colander | 135 | Escargot dish | 401 |
| Asparagus peeler | 109 | Chocolate/cocktail fountain | 473 | Ethnic cuisine | 277 |
| Asparagus pot | 46 | Chopsticks | 285 | Eutectic pad | 493 |
| Avocado cutter/slicer | 139 | Cigar ashtray | 408 | F | |
| B | | Cigar case | 408 | Finger food dishes | 373 |
| Baguette basket | 480 | Cigar cutter | 408 | Fish kettle | 26, 57, 70 |
| Bain-marie | 26, 57, 71 | Citrus stripper | 111 | Fish scaler | 107 |
| Baker's blades | 275 | Cocktail picks | 179, 286, 358 | Flair bottle | 350 |
| Baking paper | 219 | Cocktail strainer | 336 | Flavour marker | 317 |
| Bar items | 327 | Cocoa dredger | 306 | Flexiform | 269 |
| Bar mat | 352 | Coffee percolator | 507 | Flexipan | 255 |
| Bar organizer | 348 | Coffee pot | 303, 389 | Floor sign | 541 |
| Barman case | 353 | Coffee urn | 506 | Flour brush | 218 |
| Baster tube | 125 | Cognac warmer | 405 | Flower vase | 405 |
| Bell reception/table | 407 | Colander | 71, 131 | Fondue set | 26, 398 |
| Bento box | 281 | Combi unit mixer/liquidiser | 554 | Food pan | 509 |
| Bins | 542 | Condiment holder | 352, 397 | Forged knives s. 18100 | 157 |
| Blender | 557 | Contact grill | 548 | French fry cutter | 140 |
| Board wall/sandwich | 488 | Conveyor Toaster | 547 | Fruit basket | 343, 392 |
| Bone-saw | 181 | Cookie press | 207 | Fryer | 550 |
| Boston cone | 340 | Cooking tongs | 125, 335 | Fuel holder | 68, 509 |
| Bottle cooler | 404, 402 | Cookware s. 1000 s/steel | 41 | Funnel | 128, 210 |
| Bottle opener | 109, 357 | Cookware s. 1100 s/steel | 37 | G | |
| Bowl | 131, 133 | Cookware s. 12200 s/steel 5-PLY | 22 | Garlic press | 113, 141 |
| Bread baskets | 392, 479 | Cookware s. 12300 s/steel 3-PLY | 50 | Glass cleaning brush | 354 |
| Bread box | 275 | Cookware s. 15300-15400 copper | 26 | Glass clip holder | 358 |
| Bread cutter | 487 | Cookware s. 15600 copper 3-PLY | 24 | Glass rimmer | 352 |
| Breakfast tray with legs | 514 | Cookware s. 2000 s/steel | 44 | Glasses | 341 |
| Broom + dust pan | 539 | Cookware s. 2100 s/steel | 40 | Gloves | 185 |
| Brushes | 108, 113, 126, 217, 275, 292 | Cookware s. 2500 s/steel 3-PLY | 48 | GN melamine food pans | 95 |
| Bucket with wringer | 541 | Cookware s. 6100 aluminum | 53 | GN polycarbonate food pans | 84 |
| Buffet baskets/crates | 489 | Core stripper | 141 | GN polypropylene food pans | 88 |
| Buffet display | 472 | Cream dispenser | 210 | GN porcelain food pans | 97 |
| Buffet stand | 470, 490, 498 | Cream whipper | 324 | GN s/steel food pans | 74 |
| Buffet trays | 464, 471 | Crepe machine | 550 | GN trays | 359, 493 |
| Butcher trays | 181 | Croissant cutter | 215 | GN Tritan food pans | 86 |
| Butchers table | 184 | Cutlery box | 397, 481, 518 | Graduated bucket | 132 |
| Butter churn | 144 | Cutting board rack | 185 | Graduated jug | 128 |
| Butter cup | 392 | Cutting boards PE | 183 | Graters | 113, 144 |
| Butter curler | 110, 115 | D | | Gravy boat | 392 |
| Butter spreader | 108 | Dash bottle | 349 | Griddle plate | 65, 399 |
| Butter warmer | 29 | Decorating carving tools | 143 | Grill pan | 64 |
| C | | Dehydrator | 552 | Guitar | 214 |
| Cake marker | 216 | Delivery bag | 297 | H | |
| Cake pans aluminum | 226 | Dining room trolleys | 511 | Ham stand | 181 |
| Cake pans non stick | 228 | Dish dolly | 519 | Hamburger press | 182 |
| Cake stand | 309 | Dish racks | 516 | Hangiri/sushi rice tub | 287 |
| Can opener | 109, 114, 145, 566 | Dish-warmer | 551 | Heating units | 510 |
| Candelabra | 405 | Display cases | 313, 491, 551 | Hooks | 180 |
| Candleholder | 406 | Display tray | 181, 218 | Housekeeping cart | 539 |
| Canister with lid | 497 | Disposable glasses | 320, 321, 322 | I | |
| Caramelising rod | 211 | Dolly | 518, 542 | Ice box | 347, 492 |
| Caramelizer | 210, 564 | Dome cover | 309, 348, 467 | Ice chisels | 143 |
| Cash tray | 308 | Drainer plate | 83 | Ice cream basin | 315 |
| Caviar cooler | 401 | Draining rack | 208, 519 | Ice cream cone holder | 318 |

| | | | | | |
|--------------------------------------|---------------|-------------------------------|----------------|------------------------|-----------------|
| Ice cream cup | 319 | O | Soup tureen | 507, 562 | |
| Ice cream maker | 551 | Octopus press | 136 | Sous vide cooker | 560 |
| Ice cream scoop | 315 | Oil pourer | 288 | Spatulas | 102, 118, 124 |
| Ice crusher | 345, 559 | Orange juicer | 344, 556 | Spoon holder | 306 |
| Ice dipper | 114, 316 | Oven dishes | 72, 438 | Spray gun | 211 |
| Ice molds | 346 | Oyster plate | 473 | Sprayer oil/vinager | 396 |
| Icing bag | 206 | P | Squeeze bottle | 129 | |
| Induction adapter | 134 | Pans non-stick coated | 56 | Steamer | 287 |
| Induction cooker | 508 | Party tub | 474 | Stirrers | 334 |
| Infrared lamp | 553 | Pastry cutters s/steel | 189 | Straws | 333 |
| Insulated container | 296 | Pastry rings micro-perforated | 222 | String holder | 181 |
| Iron pans | 58 | Pastry stand | 382, 344 | Sturdy chair | 538 |
| J | | Pastry wheel | 107, 215 | Sugar bag holder | 307 |
| Japanese knives | 176 | Pedal bin | 539, 543 | Sugar dredger | 218, 306 |
| Jar opener | 113 | Pepper/salt mills | 409 | Sugar lamp | 211 |
| Jelly fuel | 510 | Peugeot | 409 | Swivel peeler | 110 |
| Jigger | 337 | Piping tip adapter | 205 | Syrup density meter | 213 |
| Jug | 342, 389 | Pizza delivery bag | 298 | T | |
| Juice/cereal dispensers | 498 | Pizza items | 291 | Tab-grabber | 127 |
| K | | Pizza pans | 299 | Table cloth clips | 397 |
| Kitchen needles | 179 | Pizza peels | 291 | Table crumbler | 398 |
| Kitchen utensils | 101 | Pizza screens | 298 | Table sign | 406 |
| Knife block | 178 | Pizza wheel | 294 | Table top cutter | 552 |
| Knife case | 177 | Placemats | 380 | Table top waste bin | 400 |
| Knife sharpener | 177, 566 | Planetary mixer | 559 | Tastevin | 405 |
| Knife sterilizer | 179 | Plate cover | 127 | Tea bag holder | 307 |
| L | | Potato masher | 113 | Tea pot | 284, 303 |
| Labels | 155 | Potato peeler | 110 | Tea strainer | 391 |
| Ladles | 121 | Potato ricer | 140 | Thermic hot box | 513 |
| Lemon squeezer | 344 | Poultry scissors | 173 | Thermometers | 148 |
| Lobster cracker/pick | 400 | Pourer | 355 | Tiki mugs | 332 |
| M | | Presse canard | 136 | Tilt truck | 544 |
| Magnetic knife rack | 178 | Punch bowl | 474 | Toast rack | 391 |
| Mandoline | 141 | R | | Tomato cutter | 136 |
| Marinating syringe | 125 | Rack | 126, 299, 353 | Tomato juicer sieve | 146 |
| Measuring cups/spoon | 128 | Raclette maker | 398 | Tomato peeler | 110 |
| Meat mincer | 564 | Rechaud | 284, 399 | Toothpicks | 358 |
| Meat tenderizer | 181 | Roasting pan | 57, 70 | Trays non-slip | 359 |
| Mechanical sweeper | 539 | Rolling pin | 215 | Trays s/steel | 476 |
| Melon baller | 109, 114 | S | | Trivet | 36, 62, 400 |
| Menu holder | 406 | Salad spinner | 134 | Truffle slicer | 394 |
| Microwave oven | 560 | Salamander | 549 | V | |
| Milk pot | 307 | Salami pricker | 177 | Vegetable cutter | 137 |
| Mini cookware s. 12200 s/steel 3-PLY | 30 | Salt shaker | 395 | Vegetable mills/slicer | 146, 566 |
| Mini cookware s. 15600 copper 3-PLY | 28 | Samovar | 506 | Vegetable peeler | 139 |
| Mini cookware s. 16130 aluminum | 32 | Sausage filler | 182 | W | |
| Mini cookware s. 16140 aluminum | 33 | Scales | 155, 156 | Waffle iron | 552 |
| Mini cookware s. 41210 stoneware | 34 | Scissors | 173 | Wall clock | 155 |
| Mirrors acrylic | 478 | Scoop | 130, 345 | Warming display | 551 |
| Mixer | 554 | Scraper | 301 | Warming plate | 554 |
| Mixing bowl | 26, 133 | Seafood tray | 401 | Wasabi grater | 288 |
| Mixing glass | 340 | Serving trolley | 511, 538 | Waste bin | 542 |
| Molds polycarbonate | 237 | Shaker | 339 | Weck jars/glasses | 386 |
| Molds silicone | 236, 251 | Sharpening steel | 172 | Whisk | 105 |
| Mop | 540 | Shearing knives s. 18000 | 160 | Whistling kettle | 71, 550, 559 |
| Mortar | 288 | Showplate cooled | 492 | Wine bucket stand | 403 |
| Moscow mule mug | 329 | Sieves | 130, 218 | Wine buckets | 402 |
| Mustard cup | 392 | Sieving juicer | 555 | Wine holder | 405 |
| N | | Skimmer | 103, 122 | Wine vacuum pump | 357 |
| Napkin holder | 308, 317, 397 | Slate items | 381 | Wire cutter | 140, 213 |
| Newspaper stick | 407 | Slicing machine | 182, 565 | Wok pan | 33, 49, 59, 287 |
| Nitro Whip | 305 | Smoker | 552 | Wooden cutting boards | 367 |
| Nozzles | 199, 204 | Smoking chips/gun | 348 | Z | |
| Nut craker | 400 | Snacks holders | 364 | Zucchini corer | 109 |
| Nutmeg mill | 432 | Soda siphon | 344 | | |

| | | | |
|-----------------------------|--------------------|---|---------------|
| A | | | |
| Acciaio | 172 | Cavalletto segnalatore | 541 |
| Accumulatore di freddo | 493 | Cavatappi | 357 |
| Adattatore induzione | 134 | Centrifuga | 134, 555 |
| Adattatore per bocchette | 205 | Ceppa | 184 |
| Affetta formaggio | 108, 112 | Ceppo portacoltelli | 178 |
| Affetta mozzarella/pomodori | 136 | Cesta baguettes | 480 |
| Affettatrice | 182, 565 | Cesta pane | 275 |
| Affilacoltelli | 177, 566 | Cestelli lavabicchieri | 516 |
| Affumicatoio | 552 | Cesti pane | 392, 479 |
| Affumicatore | 348 | Cesti/casse buffet | 489 |
| Aghi cucina | 179 | Cesto frutta | 343, 392 |
| Alzata torta | 309 | Cesto uova | 481 |
| Alzate buffet | 469, 495 | Chafing dishes | 501 |
| Alzate dolci | 382, 344 | Chitarra | 214 |
| Anelli uova | 138 | Clip reggibicchiere | 358 |
| Apribarattoli | 113 | Cloche | 309, 348 |
| Apriscatole | 109, 114, 145, 566 | Colapasta | 71, 131 |
| Apriuovo | 138 | Colino cocktail | 336 |
| Ardesia | 381 | Colonna portasecchiello | 403 |
| Arricciaburro | 110, 115 | Coltelli forgiati s. 18100 | 157 |
| Aspirapolvere meccanico | 539 | Coltelli giapponesi | 176 |
| Asta porta scontrini | 127 | Coltelli tranciati s. 18000 | 160 |
| Attrezzi decoro | 143 | Combi mixer/frusta | 554 |
| B | | Complementi inox | 69 |
| Bacchette cinesi | 285 | Compressore | 211 |
| Bacinella | 131, 133 | Cono boston | 340 |
| Bacinella gelato | 315 | Contentitore isotermico | 296 |
| Bagnomaria | 26, 57, 71 | Coppa burro | 392 |
| Bar | 327 | Coppa caviale | 401 |
| Barattolo vetro | 497 | Coppa gelato | 319 |
| Barbecue da tavola | 65, 399 | Coppa punch | 474 |
| Barra magnetica | 178 | Copripiatto | 127 |
| Bastardella | 26, 133 | Cornetto cinese | 135 |
| Batticarne | 181 | Cottura sottovuoto | 560 |
| Benna | 544 | Crepiera | 550 |
| Bicchiere miscelatore | 340 | Cucina etnica | 277 |
| Bicchieri | 341 | Cuociasparagi | 46 |
| Bicchierini monouso | 320, 321, 322 | Cuocivapore | 287 |
| Bidone | 542 | Cutter da tavolo | 552 |
| Bilance | 155, 156 | D | |
| Bistecchiera | 64 | Disidratatore | 552 |
| Bocchette decorative | 199, 204 | Display per buffet | 472 |
| Bollitore | 71, 550, 559 | Distributori succhi/cereali | 498 |
| Bordatore | 352 | Dosa creme | 210 |
| Borsa isotermica | 297 | E | |
| Bottiglia angostura | 349 | Espositore buffet | 470, 498 |
| Box portaghiaccio | 492 | Etichette | 155 |
| Box termico | 513 | F | |
| Brasiera | 57, 70 | Fasce microforate | 222 |
| C | | Fasciatoio | 538 |
| Caffettiera | 303, 389 | Ferma prosciutto | 181 |
| Campana | 310, 467 | Fermatovaglia | 397 |
| Campanella | 407 | Finger food | 373 |
| Candelabro | 405 | Flacone | 129 |
| Cannello | 212 | Flair bottle | 350 |
| Cannucce | 333 | Flexiform | 269 |
| Caraffa | 342, 389 | Flexipan | 255 |
| Caraffa graduata | 128 | Fonduta | 26, 398 |
| Caraffa termica | 388, 500 | Fontana cioccolato/cocktails | 473 |
| Caramellizzatore | 210, 564 | Forbici | 173 |
| Carapina | 315 | Formaggiera | 396 |
| Carrelli sala | 511 | Friggitrice | 550 |
| Carrello | 518, 542 | Frullatore | 557 |
| Carrello di servizio | 511, 538 | Frusta | 105 |
| Carrello lavapavimenti | 541 | G | |
| Carrello portabiancheria | 539 | Ganci | 180 |
| Carrello portapiatti | 519 | Gel combustibile | 510 |
| Carta da forno | 219 | Glacette | 404 |
| | | GN inox | 74 |
| | | GN melamina | 95 |
| | | GN policarbonato | 84 |
| | | GN polipropilene | 88 |
| | | GN porcellana | 97 |
| | | GN Tritan | 86 |
| | | Grattugia wasabi | 288 |
| | | Grattugie | 113, 144 |
| | | Grembiule | 185, 353 |
| | | Griglia di colaggio | 208 |
| | | Griglia in filo | 83 |
| | | Grill a contatto | 548 |
| | | Guanti | 185 |
| | | I | |
| | | Imbuto | 128, 210 |
| | | Insacatrice | 182 |
| | | L | |
| | | Lame panettiere | 275 |
| | | Lampada infrarossi | 553 |
| | | Lampada zucchero | 211 |
| | | Lattiera | 307 |
| | | Lavagna | 488 |
| | | Legatovagliolo | 397 |
| | | Levacapsule | 109, 358 |
| | | Levatorsoli | 111, 114 |
| | | Lira | 140, 213 |
| | | M | |
| | | Macchina gelato | 551 |
| | | Macchina per cialde | 552 |
| | | Macchina raclette | 398 |
| | | Macina noce moscata | 432 |
| | | Macinapepe/sale | 409 |
| | | Mandolino | 141 |
| | | Mestoli | 121 |
| | | Microonde | 560 |
| | | Miscelatori cocktail | 334 |
| | | Misurini | 128 |
| | | Misurino cocktail | 337 |
| | | Mixer | 554 |
| | | Mop | 540 |
| | | Mortaio | 288 |
| | | N | |
| | | Nebulizzatore olio/acetato | 396 |
| | | O | |
| | | Oliera | 288 |
| | | Omogeneizzatore | 555 |
| | | Orologio da parete | 155 |
| | | P | |
| | | Padelle antiaderenti | 56 |
| | | Padelle ferro | 58 |
| | | Pale pizza | 291 |
| | | Passapomodoro | 146 |
| | | Passath | 391 |
| | | Passaverdura | 146, 566 |
| | | Pattumiera | 539, 543 |
| | | Pedana | 544 |
| | | Pela asparagi | 109 |
| | | Pela mele | 138 |
| | | Pelapatate | 110 |
| | | Pelapomodori | 110 |
| | | Pelaverdure | 139 |
| | | Penna aerografa | 211 |
| | | Penna gesso liquido | 317 |
| | | Pennelli | 108, 113, 217 |
| | | Pentolame ghisa smaltata | 60 |
| | | Pentolame miniature ghisa smaltata | 35 |
| | | Pentolame miniature s. 12200 inox 3-PLY | 30 |
| | | Pentolame miniature s. 15600 rame 3-PLY | 28 |
| | | Pentolame miniature s. 16130 alluminio | 32 |
| | | Pentolame miniature s. 16140 alluminio | 33 |

| | | | | | |
|--|---------------|-------------------------|---------------|------------------------|-----------------|
| Pentolame miniature s. 41210 stoneware | 34 | S | | Svuota carciofi | 139 |
| Pentolame s. 1000 inox | 41 | Sacchetto per decorare | 206 | Svuota zucchine | 109 |
| Pentolame s. 1100 inox | 37 | Salamandra | 549 | T | |
| Pentolame s. 12200 inox 5-PLY | 22 | Salsiera | 392 | Taglia ananas | 137 |
| Pentolame s. 12300 inox 3-PLY | 50 | Samovar | 506 | Taglia avocado | 139 |
| Pentolame s. 15300-15400 rame | 26 | Sbucciatore | 110 | Taglia croissants | 215 |
| Pentolame s. 15600 rame 3-PLY | 24 | Scaldaburro | 29 | Taglia pane | 487 |
| Pentolame s. 2000 inox | 44 | Scaldacaff- | 506 | Taglia patate | 140 |
| Pentolame s. 2100 inox | 40 | Scaldacognac | 405 | Taglia uova | 138 |
| Pentolame s. 2500 inox 3-PLY | 48 | Scaldapiatti | 551 | Taglia verdure | 137 |
| Pentolame s. 6100 alluminio | 53 | Scaldavivande | 501 | Tagliapasta inox | 189 |
| Percolatore | 507 | ScalPELLI ghiaccio | 143 | Tagliasigari | 408 |
| Pesa sciroppo | 213 | Scatola bento | 281 | Tagliatartufi | 394 |
| Pesciera | 26, 57, 70 | Scavino | 109, 114 | Tagliaverdure | 556 |
| Pestaghiaccio | 345 | Schiaccianoci | 400 | Taglieri legno | 367 |
| Peugeot | 409 | Schiacciapotate | 140 | Taglieri PE | 183 |
| Piano caldo | 554 | Schiumarola | 103, 122 | Tappeto bar | 352 |
| Piastra ad induzione | 508 | Sciabola Sommelier | 405 | Tappo dosatore | 355 |
| Piastre elettriche | 510 | Scolapiatti | 519 | Tappo spumante | 357 |
| Piatto frutti di mare | 473 | Scopa a forcice | 539 | Targhetta tavola | 406 |
| Piatto lumache | 401 | Secchi vino | 402 | Tastevin | 405 |
| Pinza | 125, 335 | Secchio | 132 | Tazza moscow mule | 329 |
| Pinza aragosta | 400 | Secchio con strizzatore | 541 | Teglie pizza | 299 |
| Pirofile Appolia | 438 | Secchio ghiaccio | 347 | Teiera | 284, 303 |
| Pirofile forno | 72, 438 | Secchio portabottiglie | 474 | Temperatrice | 211 |
| Pistola elettrica | 211 | Sega per ossa | 181 | Termometri | 148 |
| Pizza | 291 | Segatura aromatizzata | 348 | Tiki mug | 332 |
| Planetaria | 559 | Seggiolone | 538 | Tortiere alluminio | 226 |
| Pompa sottovuoto | 357 | Segnagusto | 317 | Tortiere antiaderenti | 228 |
| Pompetta per sugo | 125 | Segnaporzioni | 216 | Tostapane | 547 |
| Porta coltelli | 178 | Senapiera | 392 | Tovaglette | 380 |
| Porta coni | 318 | Separauova | 115 | Trinciapollo | 173 |
| Porta cucchiaini | 306 | Servitartufi | 395 | Tritacarne | 564 |
| Porta men | 406 | Sessola | 130, 345 | Tritaghiaccio | 345, 559 |
| Porta oggetti bar | 348 | Setacci | 130, 218 | U | |
| Porta posate | 397, 481, 518 | Shaker | 339 | Utensili cucina | 101 |
| Porta rifiuti | 400, 542 | Sifone nitro | 305 | V | |
| Porta sigaro | 408 | Sifone panna | 324 | Valigia Barman | 353 |
| Porta snack | 364 | Sifone soda | 344 | Valigia cuoco | 177 |
| Porta spago | 181 | Siringa per marinata | 125 | Vasca hangiri | 287 |
| Porta taglieri | 185 | Siringa per pasticceria | 207 | Vasetti Weck | 386 |
| Porta tovaglioli | 308, 317 | Snocciolatore | 141 | Vaso fiori | 405 |
| Portabustine th-/zucchero | 307 | Sottopentola | 36, 62, 400 | Vassoi appetizer | 367 |
| Portacandela | 406 | Spalmaburro | 108 | Vassoi buffet | 464, 471 |
| Portacombustibile | 68, 509 | Spargi zucchero | 218, 306 | Vassoi GN | 359, 493 |
| Portacondimenti | 352, 397 | Spargicacao | 306 | Vassoi inox | 476 |
| Portagiorinale | 407 | Spargiformaggio | 397 | Vassoi macelleria | 181 |
| Portatoast | 391 | Spargisale | 395 | Vassoio antiscivolo | 359 |
| Portauovo | 391 | Spatola gelato | 315 | Vassoio conto | 308 |
| Portavivande | 509 | Spatole | 102, 118, 124 | Vassoio espositore | 181, 218 |
| Porzionatore | 114, 316 | Spazzola lavabicchieri | 354 | Vassoio frutti di mare | 401 |
| Posacenere | 407 | Spazzola per farina | 218 | Vassoio room service | 514 |
| Posate caviale | 401 | Spazzole | 126, 275, 292 | Versavino | 405 |
| Pressa-hamburger | 182 | Specchi acrilico | 478 | Vetrina da banco | 313 |
| Pressapatate | 113 | Spiedini cocktail | 179, 286, 358 | Vetrina refrigerata | 492 |
| Pressapolipo | 136 | Spremiaglio | 113, 141 | Vetrina riscaldata | 551 |
| Presse canard | 136 | Spremiagrumi | 344, 556 | Vetrina sigari | 408 |
| Pungisalame | 177 | Spremillimone | 344 | Vetrine | 491, 551 |
| R | | Spumantiera | 402 | W | |
| Raccoglibriciole | 398 | Squamapesce | 107 | Waffels | 268 |
| Raschia | 301 | Stampi ghiaccio | 346 | Weck | 386 |
| Rastelliera | 126, 299, 353 | Stampi policarbonato | 237 | Wok | 33, 49, 59, 287 |
| Rechaud | 284, 399 | Stampi silicone | 236, 251 | Z | |
| Retine pizza | 298 | Stampo burro | 144 | Zaino isoteramico | 298 |
| Rigalimoni | 111 | Sterilizzatore | 179 | Zuppiera | 507, 562 |
| Rompighiaccio | 345 | Stiletto aragosta | 400 | | |
| Rotella taglia pizza | 294 | Stuzzicadenti | 358 | | |
| Rotelle taglia pasta | 107, 215 | Supporto buffet | 490 | | |
| Rullo | 215 | Svuota ananas | 109, 137 | | |

NUMERICAL INDEX

INDICE NUMERICO

NUMERISCH INDEX

INDEX NUMERIQUE

INDICE NUMERICO

NUMERICAL INDEX INDICE NUMERICO NUMERISCH INDEX INDEX NUMERIQUE INDICE NUMERICO

| Cod. | pag. | Cod. | pag. | Cod. | pag. | Cod. | pag. | Cod. | pag. | Cod. | pag. | Cod. | pag. |
|----------|------|----------|------|----------|------|----------|------|----------|------|----------|------|----------|------|
| 11001-16 | 42 | 11014F20 | 567 | 11113-26 | 39 | 11713-32 | 59 | 11910-12 | 71 | 11952-36 | 133 | 11974-50 | 121 |
| 11001-18 | 42 | 11014F24 | 567 | 11114-20 | 39 | 11713-40 | 59 | 11910-14 | 71 | 11952-40 | 133 | 11974-70 | 121 |
| 11001-20 | 42 | 11014F28 | 567 | 11114-24 | 39 | 11714-20 | 59 | 11910-16 | 71 | 11953-16 | 134 | 11975-01 | 122 |
| 11001-22 | 42 | 11014F32 | 567 | 11114-28 | 39 | 11714-22 | 59 | 11910-18 | 71 | 11953-22 | 134 | 11975-50 | 122 |
| 11001-24 | 42 | 11061-12 | 43 | 11114-32 | 39 | 11714-24 | 59 | 11910-20 | 71 | 11954-26 | 134 | 11975-99 | 122 |
| 11001-28 | 42 | 11061-16 | 43 | 11114-36 | 39 | 11714-26 | 59 | 11911-12 | 71 | 11954-30 | 134 | 11976-50 | 122 |
| 11001-32 | 42 | 11061-18 | 43 | 11114-40 | 39 | 11714-28 | 59 | 11911-14 | 71 | 11954-32 | 134 | 11976-99 | 122 |
| 11001-36 | 42 | 11061-20 | 43 | 11114-45 | 39 | 11714-32 | 59 | 11911-16 | 71 | 11954-36 | 134 | 11982-01 | 122 |
| 11001-40 | 42 | 11061-22 | 43 | 11115-20 | 39 | 11714-36 | 59 | 11911-18 | 71 | 11954-37 | 134 | 11982-38 | 121 |
| 11001-45 | 42 | 11061-24 | 43 | 11115-24 | 39 | 11714-40 | 59 | 11911-20 | 71 | 11954-40 | 134 | 11982F38 | 568 |
| 11001-50 | 42 | 11061-28 | 43 | 11115-28 | 39 | 11714-45 | 59 | 11913-16 | 71 | 11955-32 | 131 | 11983-37 | 121 |
| 11001-60 | 42 | 11061-32 | 43 | 11115-32 | 39 | 11714-50 | 59 | 11913-20 | 71 | 11955-36 | 131 | 11983-38 | 121 |
| 11006-12 | 43 | 11061-36 | 43 | 11115-36 | 39 | 11715-12 | 36 | 11913-24 | 71 | 11955-40 | 131 | 11984-38 | 121 |
| 11006-14 | 43 | 11061-40 | 43 | 11115-40 | 39 | 11716-16 | 59 | 11913-28 | 71 | 11955-45 | 131 | 11985-34 | 122 |
| 11006-16 | 43 | 11061-45 | 43 | 11115-45 | 39 | 11716-20 | 59 | 11922-36 | 71 | 11955-50 | 131 | 11990-16 | 123 |
| 11006-18 | 43 | 11061-50 | 43 | 11115-50 | 39 | 11716-22 | 59 | 11922-40 | 71 | 11956-37 | 474 | 11991-16 | 123 |
| 11006-20 | 43 | 11101-16 | 38 | 11117-20 | 39 | 11716-24 | 59 | 11924-18 | 132 | 11956-42 | 474 | 12001-16 | 45 |
| 11006-22 | 43 | 11101-20 | 38 | 11117-24 | 39 | 11716-26 | 59 | 11924-20 | 132 | 11957-20 | 131 | 12001-18 | 45 |
| 11006-24 | 43 | 11101-24 | 38 | 11117-28 | 39 | 11716-28 | 59 | 11924-22 | 132 | 11957-25 | 131 | 12001-20 | 45 |
| 11006-28 | 43 | 11101-28 | 38 | 11117-32 | 39 | 11716-32 | 59 | 11924-24 | 132 | 11957-30 | 131 | 12001-22 | 45 |
| 11006-32 | 43 | 11101-32 | 38 | 11117-36 | 39 | 11716-36 | 59 | 11924-28 | 132 | 11957-35 | 131 | 12001-24 | 45 |
| 11006-36 | 43 | 11101-36 | 38 | 11117-40 | 39 | 11716-40 | 59 | 11924F20 | 567 | 11957-40 | 131 | 12001-28 | 45 |
| 11007-16 | 42 | 11101-40 | 38 | 11119-20 | 38 | 11716-45 | 59 | 11926-22 | 132 | 11965-50 | 70 | 12001-32 | 45 |
| 11007-18 | 42 | 11101-45 | 38 | 11119-28 | 38 | 11717-34 | 59 | 11926-26 | 132 | 11965-60 | 70 | 12001-36 | 45 |
| 11007-20 | 42 | 11101-50 | 38 | 11123-20 | 38 | 11717-37 | 59 | 11927-24 | 131 | 11965-61 | 70 | 12001-40 | 45 |
| 11007-22 | 42 | 11102-28 | 38 | 11123-24 | 38 | 11717-42 | 59 | 11927-28 | 131 | 11966-50 | 573 | 12001-45 | 45 |
| 11007-24 | 42 | 11102-32 | 38 | 11123-28 | 38 | 11717-47 | 59 | 11927-32 | 131 | 11966-60 | 573 | 12001-50 | 45 |
| 11007-28 | 42 | 11102-36 | 38 | 11161-12 | 39 | 11718-20 | 58 | 11927-36 | 131 | 11966-61 | 573 | 12001-60 | 45 |
| 11007-32 | 42 | 11102-40 | 38 | 11161-14 | 39 | 11718-22 | 58 | 11927-40 | 131 | 11967-06 | 121 | 12001F20 | 568 |
| 11007-36 | 42 | 11102-45 | 38 | 11161-16 | 39 | 11718-24 | 58 | 11927-45 | 131 | 11967-08 | 121 | 12001F24 | 568 |
| 11007-40 | 42 | 11102-50 | 38 | 11161-18 | 39 | 11739-20 | 299 | 11927-50 | 131 | 11967-09 | 121 | 12001F28 | 568 |
| 11007-45 | 42 | 11102-99 | 573 | 11161-20 | 39 | 11739-24 | 299 | 11928-32 | 131 | 11967-10 | 121 | 12007-16 | 45 |
| 11007-50 | 42 | 11105-20 | 38 | 11161-22 | 39 | 11739-28 | 299 | 11928-36 | 131 | 11967-12 | 121 | 12007-18 | 45 |
| 11007-60 | 42 | 11105-24 | 38 | 11161-24 | 39 | 11739-32 | 299 | 11928-40 | 131 | 11967-14 | 121 | 12007-20 | 45 |
| 11008-16 | 43 | 11105-28 | 38 | 11161-28 | 39 | 11739F20 | 567 | 11929-20 | 135 | 11967-16 | 121 | 12007-22 | 45 |
| 11008-18 | 43 | 11105-36 | 38 | 11161-32 | 39 | 11739F24 | 567 | 11929-24 | 135 | 11967-18 | 121 | 12007-24 | 45 |
| 11008-20 | 43 | 11106-14 | 38 | 11161-36 | 39 | 11739F28 | 567 | 11930-24 | 131 | 11967-20 | 121 | 12007-28 | 45 |
| 11008-24 | 43 | 11106-16 | 38 | 11161-40 | 39 | 11739F32 | 567 | 11930-28 | 131 | 11967-24 | 121 | 12007-32 | 45 |
| 11008-28 | 43 | 11106-20 | 38 | 11161-45 | 39 | 11740-14 | 299 | 11930-32 | 131 | 11968-18 | 121 | 12007-36 | 45 |
| 11008-32 | 43 | 11106-24 | 38 | 11161-50 | 39 | 11740-16 | 299 | 11930-36 | 131 | 11968-20 | 121 | 12007-40 | 45 |
| 11008-36 | 43 | 11106-28 | 38 | 11161-60 | 39 | 11740-18 | 299 | 11930-40 | 131 | 11968-24 | 121 | 12007-45 | 45 |
| 11009-16 | 42 | 11106-32 | 38 | 11161F16 | 567 | 11740-20 | 299 | 11930-45 | 131 | 11969-02 | 122 | 12007-50 | 45 |
| 11009-18 | 42 | 11106-36 | 38 | 11161F20 | 567 | 11740-22 | 299 | 11930-50 | 131 | 11969-06 | 121 | 12007-60 | 45 |
| 11009-20 | 42 | 11107-16 | 38 | 11161F24 | 567 | 11740-24 | 299 | 11930F24 | 567 | 11969-37 | 121 | 12007F16 | 568 |
| 11009-24 | 42 | 11107-20 | 38 | 11161F28 | 567 | 11740-26 | 299 | 11932-20 | 135 | 11970-01 | 122 | 12007F24 | 568 |
| 11009-28 | 42 | 11107-24 | 38 | 11617-20 | 56 | 11740-28 | 299 | 11932-24 | 135 | 11970-06 | 121 | 12007F28 | 568 |
| 11009-32 | 42 | 11107-28 | 38 | 11617-24 | 56 | 11740-30 | 299 | 11941-35 | 70 | 11970-08 | 121 | 12009-16 | 45 |
| 11009-36 | 42 | 11107-32 | 38 | 11617-28 | 56 | 11740-32 | 299 | 11941-40 | 70 | 11970-09 | 121 | 12009-18 | 45 |
| 11009-40 | 42 | 11107-36 | 38 | 11617-32 | 56 | 11740-36 | 299 | 11941-45 | 70 | 11970-10 | 121 | 12009-20 | 45 |
| 11009-45 | 42 | 11107-40 | 38 | 11617-36 | 56 | 11740-40 | 299 | 11941-50 | 70 | 11970-11 | 121 | 12009-24 | 45 |
| 11009-50 | 42 | 11107-45 | 38 | 11617-40 | 56 | 11741-20 | 299 | 11941-60 | 70 | 11970-12 | 121 | 12009-28 | 45 |
| 11009-60 | 42 | 11107-50 | 38 | 11701-02 | 291 | 11741-24 | 299 | 11943-40 | 70 | 11970-14 | 121 | 12009-32 | 45 |
| 11010-16 | 42 | 11108-16 | 38 | 11701-06 | 291 | 11741-26 | 299 | 11943-45 | 70 | 11970-16 | 121 | 12009-36 | 45 |
| 11010-18 | 42 | 11108-20 | 38 | 11701-10 | 291 | 11741-28 | 299 | 11943-50 | 70 | 11970F06 | 568 | 12009-40 | 45 |
| 11010-20 | 42 | 11108-24 | 38 | 11701-13 | 291 | 11741-32 | 299 | 11943-60 | 70 | 11970F08 | 568 | 12009-45 | 45 |
| 11010-24 | 42 | 11108-28 | 38 | 11701-16 | 291 | 11742-16 | 299 | 11943-61 | 70 | 11970F10 | 568 | 12009-50 | 45 |
| 11011-16 | 43 | 11108-32 | 38 | 11702-02 | 291 | 11742-18 | 299 | 11944-40 | 70 | 11971-01 | 123 | 12009-60 | 45 |
| 11011-18 | 43 | 11108-36 | 38 | 11702-06 | 291 | 11742-20 | 299 | 11944-45 | 70 | 11971-08 | 122 | 12037-16 | 46 |
| 11011-20 | 43 | 11109-16 | 38 | 11702-10 | 291 | 11742-22 | 299 | 11944-50 | 70 | 11971-10 | 122 | 12101-16 | 40 |
| 11011-24 | 43 | 11109-20 | 38 | 11702-16 | 291 | 11742-24 | 299 | 11944-60 | 70 | 11971-12 | 122 | 12101-20 | 40 |
| 11012-16 | 42 | 11109-24 | 38 | 11704-02 | 291 | 11742-26 | 299 | 11944-61 | 70 | 11971-14 | 122 | 12101-24 | 40 |
| 11012-18 | 42 | 11109-28 | 38 | 11704-06 | 291 | 11742-28 | 299 | 11948-40 | 70 | 11971-16 | 122 | 12101-28 | 40 |
| 11012-20 | 42 | 11109-32 | 38 | 11704-13 | 291 | 11742-30 | 300 | 11948-45 | 70 | 11971-18 | 122 | 12101-32 | 40 |
| 11012-24 | 42 | 11109-36 | 38 | 11704-16 | 291 | 11742-32 | 300 | 11948-50 | 70 | 11971-20 | 122 | 12101-36 | 40 |
| 11013-18 | 42 | 11109-40 | 38 | 11705-02 | 291 | 11742-36 | 300 | 11948-60 | 70 | 11971-25 | 122 | 12101-40 | 40 |
| 11013-20 | 42 | 11109-45 | 38 | 11705-06 | 291 | 11742-40 | 300 | 11948-61 | 70 | 11971F10 | 568 | 12101-45 | 40 |
| 11013-24 | 42 | 11109-50 | 38 | 11705-10 | 291 | 11742-45 | 300 | 11951-22 | 133 | 11971F12 | 568 | 12101-50 | 40 |
| 11013-26 | 42 | 11112-16 | 39 | 11705-14 | 291 | 11742-50 | 300 | 11951-26 | 133 | 11972-10 | 122 | 12107-16 | 40 |
| 11014-20 | 43 | 11112-18 | 39 | 11706-02 | 291 | 11742-60 | 300 | 11951-32 | 133 | 11972-12 | 122 | 12107-20 | 40 |
| 11014-24 | 43 | 11112-20 | 39 | 11706-06 | 291 | 11744-20 | 299 | 11951-36 | 133 | 11973-01 | 122 | 12107-24 | 40 |
| 11014-28 | 43 | 11112-24 | 39 | 11706-10 | 291 | 11744-24 | 299 | 11951-40 | 133 | 11973-10 | 122 | 12107-28 | 40 |
| 11014-32 | 43 | 11113-18 | 39 | 11706-14 | 291 | 11744-28 | 299 | 11952-22 | 133 | 11973-12 | 122 | 12107-32 | 40 |
| 11014-36 | 43 | 11113-20 | 39 | 11710-AA | 59 | 11744-32 | 299 | 11952-26 | 133 | 11973F10 | 568 | 12107-36 | 40 |
| 11014-40 | 43 | 11113-24 | 39 | 11710-AB | 59 | 11760-11 | 83 | 11952-32 | 133 | 11973F12 | 568 | 12107-40 | 40 |

| Cod. | pag. | Cod. | pag. | Cod. | pag. | Cod. | pag. | Cod. | pag. | Cod. | pag. | Cod. | pag. |
|----------|------|----------|------|----------|------|----------|------|----------|------|----------|------|----------|------|
| 12107-45 | 40 | 12303Y16 | 51 | 12550-73 | 458 | 12640-24 | 124 | 12940-05 | 130 | 14103F15 | 569 | 14152-06 | 78 |
| 12107-50 | 40 | 12303Y20 | 51 | 12550-74 | 458 | 12640-28 | 124 | 12940-10 | 130 | 14103F20 | 569 | 14152-10 | 78 |
| 12109-16 | 40 | 12303Y24 | 51 | 12550-77 | 458 | 12641-14 | 124 | 12940-20 | 130 | 14104-06 | 76 | 14152-15 | 78 |
| 12109-20 | 40 | 12304B26 | 51 | 12550-78 | 458 | 12641-16 | 124 | 12940-25 | 130 | 14104-10 | 76 | 14152-20 | 78 |
| 12109-24 | 40 | 12304G26 | 51 | 12550-80 | 458 | 12641-18 | 124 | 12947-02 | 198 | 14104-15 | 76 | 14155-10 | 78 |
| 12109-28 | 40 | 12304O26 | 51 | 12550-81 | 458 | 12641-20 | 124 | 12947-03 | 198 | 14104F06 | 569 | 14155-15 | 78 |
| 12109-32 | 40 | 12304W26 | 51 | 12550-83 | 458 | 12641-24 | 124 | 12947-04 | 198 | 14104F10 | 569 | 14155-20 | 78 |
| 12109-36 | 40 | 12304Y26 | 51 | 12550-84 | 458 | 12641-28 | 124 | 12947-05 | 198 | 14104F15 | 569 | 14157-10 | 78 |
| 12109-40 | 40 | 12504-20 | 127 | 12550-85 | 458 | 12642-28 | 124 | 12947-06 | 198 | 14105-02 | 76 | 14157-15 | 78 |
| 12109-45 | 40 | 12507-24 | 49 | 12550-87 | 458 | 12903-30 | 102 | 12947-07 | 198 | 14105-04 | 76 | 14157-20 | 78 |
| 12109-50 | 40 | 12507-28 | 49 | 12550-88 | 458 | 12903-40 | 102 | 12947-13 | 190 | 14105-06 | 76 | 14158-10 | 78 |
| 12123F20 | 568 | 12508-24 | 49 | 12550-89 | 458 | 12903-45 | 102 | 12967-06 | 104 | 14105-10 | 76 | 14158-15 | 78 |
| 12123F24 | 568 | 12509-20 | 49 | 12561-16 | 49 | 12905-25 | 102 | 12967-10 | 104 | 14105-15 | 76 | 14158-20 | 78 |
| 12123F28 | 568 | 12509-24 | 49 | 12561-18 | 49 | 12905-30 | 102 | 12968-10 | 104 | 14105-20 | 76 | 14159-10 | 78 |
| 12206-09 | 31 | 12509-28 | 49 | 12561-20 | 49 | 12905-35 | 102 | 12969-06 | 104 | 14105F02 | 569 | 14159-15 | 78 |
| 12206-10 | 31 | 12511-16 | 49 | 12561-24 | 49 | 12905-40 | 102 | 12969-10 | 104 | 14105F04 | 569 | 14159-20 | 78 |
| 12206-12 | 31 | 12511-18 | 49 | 12561-26 | 49 | 12905-45 | 102 | 12970-06 | 104 | 14105F06 | 569 | 14162-02 | 78 |
| 12206-16 | 23 | 12511-20 | 49 | 12561-28 | 49 | 12905-50 | 102 | 12970-08 | 104 | 14105F10 | 569 | 14162-04 | 78 |
| 12206-18 | 23 | 12511-24 | 49 | 12580-11 | 131 | 12906-35 | 102 | 12970-10 | 104 | 14105F15 | 569 | 14162-06 | 78 |
| 12206-20 | 23 | 12513-16 | 49 | 12580-17 | 131 | 12907-07 | 102 | 12970-12 | 104 | 14105F20 | 569 | 14165-02 | 78 |
| 12207-10 | 31 | 12513-18 | 49 | 12580-21 | 131 | 12907-08 | 102 | 12971-10 | 105 | 14107-06 | 76 | 14165-04 | 78 |
| 12207-24 | 23 | 12513-20 | 49 | 12580-24 | 131 | 12908-30 | 102 | 12971-12 | 105 | 14107-10 | 76 | 14165-06 | 78 |
| 12207-28 | 23 | 12513-24 | 49 | 12580-29 | 131 | 12908-35 | 102 | 12972-10 | 105 | 14107-15 | 76 | 14201-02 | 79 |
| 12208-16 | 23 | 12514-24 | 49 | 12580-30 | 131 | 12908-40 | 102 | 12972-12 | 105 | 14107-20 | 76 | 14201-04 | 79 |
| 12208-20 | 23 | 12514-26 | 49 | 12580-31 | 131 | 12909-12 | 102 | 12973-10 | 105 | 14107F06 | 569 | 14201-06 | 79 |
| 12208-24 | 23 | 12514-28 | 49 | 12580-36 | 131 | 12909-23 | 102 | 12973-12 | 105 | 14107F10 | 569 | 14201-10 | 79 |
| 12208-28 | 23 | 12514-32 | 49 | 12580-40 | 131 | 12915-25 | 102 | 12986-01 | 104 | 14107F15 | 569 | 14201-15 | 79 |
| 12211-12 | 31 | 12514-36 | 49 | 12580-45 | 131 | 12915-26 | 102 | 12986-38 | 104 | 14107F20 | 569 | 14201-20 | 79 |
| 12214-12 | 31 | 12517-24 | 49 | 12580-50 | 131 | 12915-35 | 102 | 14001-09 | 516 | 14108-06 | 76 | 14202-02 | 79 |
| 12214-20 | 23 | 12517-26 | 49 | 12582-13 | 131 | 12915-45 | 102 | 14001-16 | 516 | 14108-10 | 76 | 14202-04 | 79 |
| 12214-26 | 23 | 12517-28 | 49 | 12582-17 | 131 | 12916-25 | 102 | 14001-25 | 516 | 14108-15 | 76 | 14202-06 | 79 |
| 12214-30 | 23 | 12517-32 | 49 | 12582-22 | 131 | 12916-33 | 102 | 14001-36 | 516 | 14108-20 | 76 | 14202-10 | 79 |
| 12214-36 | 23 | 12517-36 | 49 | 12582-24 | 131 | 12920-01 | 103 | 14001-49 | 516 | 14108F06 | 569 | 14202-15 | 79 |
| 12215-12 | 31 | 12529-32 | 49 | 12582-32 | 131 | 12920-05 | 103 | 14003-09 | 516 | 14108F10 | 569 | 14202-20 | 79 |
| 12215-16 | 31 | 12550-01 | 460 | 12582-34 | 131 | 12920-10 | 103 | 14003-16 | 516 | 14108F15 | 569 | 14203-06 | 79 |
| 12217-20 | 23 | 12550-02 | 459 | 12582-38 | 131 | 12920-11 | 103 | 14003-25 | 516 | 14108F20 | 569 | 14203-10 | 79 |
| 12217-26 | 23 | 12550-03 | 461 | 12582-40 | 131 | 12920-15 | 103 | 14003-36 | 516 | 14109-06 | 76 | 14203-15 | 79 |
| 12217-30 | 23 | 12550-04 | 345 | 12604-22 | 130 | 12920-16 | 103 | 14003-49 | 517 | 14109-10 | 76 | 14203-20 | 79 |
| 12217-36 | 23 | 12550-05 | 461 | 12604-30 | 130 | 12921-01 | 103 | 14004-00 | 517 | 14109-15 | 76 | 14205-02 | 79 |
| 12238-17 | 31 | 12550-06 | 461 | 12604-34 | 130 | 12921-05 | 103 | 14006-00 | 517 | 14109-20 | 76 | 14205-04 | 79 |
| 12238-30 | 23 | 12550-07 | 461 | 12604-40 | 130 | 12921-10 | 103 | 14007-00 | 517 | 14109F06 | 569 | 14205-06 | 79 |
| 12238-35 | 23 | 12550-09 | 461 | 12605-22 | 130 | 12921-15 | 103 | 14008-00 | 517 | 14109F10 | 569 | 14205-10 | 79 |
| 12243-12 | 31 | 12550-11 | 459 | 12605-30 | 130 | 12926-35 | 105 | 14010-00 | 517 | 14109F15 | 569 | 14205-15 | 79 |
| 12261-10 | 31 | 12550-12 | 459 | 12605-34 | 130 | 12927-35 | 105 | 14011-00 | 517 | 14109F20 | 569 | 14205-20 | 79 |
| 12261-12 | 31 | 12550-13 | 459 | 12605-40 | 130 | 12927-45 | 105 | 14013-00 | 517 | 14110-06 | 76 | 14252-06 | 79 |
| 12261-16 | 23 | 12550-14 | 459 | 12606-30 | 130 | 12928-25 | 105 | 14015-08 | 517 | 14110-10 | 76 | 14252-10 | 79 |
| 12261-18 | 23 | 12550-15 | 460 | 12606-34 | 130 | 12928-30 | 105 | 14101-02 | 75 | 14110F06 | 569 | 14252-15 | 79 |
| 12261-20 | 23 | 12550-16 | 460 | 12607-22 | 131 | 12928-35 | 105 | 14101-04 | 75 | 14110F10 | 569 | 14252-20 | 79 |
| 12261-24 | 23 | 12550-17 | 460 | 12607-30 | 131 | 12928-40 | 105 | 14101-06 | 75 | 14112-10 | 77 | 14255-06 | 79 |
| 12261-28 | 23 | 12550-19 | 461 | 12607-34 | 131 | 12928-45 | 105 | 14101-10 | 75 | 14112-15 | 77 | 14255-10 | 79 |
| 12300-18 | 52 | 12550-20 | 460 | 12622-07 | 134 | 12928-50 | 105 | 14101-15 | 75 | 14112-20 | 77 | 14255-15 | 79 |
| 12300-24 | 52 | 12550-21 | 460 | 12622-10 | 134 | 12928-55 | 105 | 14101-20 | 75 | 14115-10 | 77 | 14255-20 | 79 |
| 12300B18 | 52 | 12550-22 | 459 | 12622-12 | 134 | 12928-60 | 105 | 14102-02 | 75 | 14115-15 | 77 | 14301-02 | 81 |
| 12300B24 | 52 | 12550-25 | 460 | 12622-14 | 134 | 12928F30 | 568 | 14102-04 | 75 | 14115-20 | 77 | 14301-04 | 81 |
| 12300G18 | 52 | 12550-26 | 460 | 12622-16 | 134 | 12928F35 | 568 | 14102-06 | 75 | 14117-10 | 77 | 14301-06 | 81 |
| 12300G24 | 52 | 12550-30 | 460 | 12622-18 | 134 | 12929-25 | 105 | 14102-10 | 75 | 14117-15 | 77 | 14302-02 | 81 |
| 12300O18 | 52 | 12550-33 | 460 | 12622-20 | 134 | 12929-30 | 105 | 14102-15 | 75 | 14117-20 | 77 | 14302-04 | 81 |
| 12300O24 | 52 | 12550-34 | 459 | 12622-23 | 134 | 12929-35 | 105 | 14102-20 | 75 | 14118-10 | 77 | 14302-06 | 81 |
| 12300W18 | 52 | 12550-36 | 460 | 12622-26 | 134 | 12929-40 | 105 | 14102F02 | 569 | 14118-15 | 77 | 14303-02 | 81 |
| 12300W24 | 52 | 12550-43 | 460 | 12630-22 | 134 | 12929-45 | 105 | 14102F04 | 569 | 14118-20 | 77 | 14303-04 | 81 |
| 12300Y18 | 52 | 12550-50 | 458 | 12633-16 | 134 | 12929F30 | 569 | 14102F06 | 569 | 14119-10 | 77 | 14303-06 | 81 |
| 12300Y24 | 52 | 12550-53 | 459 | 12633-18 | 134 | 12929F35 | 569 | 14102F10 | 569 | 14119-15 | 77 | 14305-02 | 81 |
| 12303B16 | 51 | 12550-54 | 459 | 12633-20 | 134 | 12930-51 | 103 | 14102F15 | 569 | 14142-20 | 77 | 14305-04 | 81 |
| 12303B20 | 51 | 12550-55 | 459 | 12633-23 | 134 | 12930-52 | 103 | 14102F20 | 569 | 14145-10 | 77 | 14305-06 | 81 |
| 12303B24 | 51 | 12550-56 | 459 | 12633-26 | 134 | 12930-62 | 103 | 14103-02 | 76 | 14145-15 | 77 | 14362-02 | 81 |
| 12303G16 | 51 | 12550-58 | 458 | 12635-23 | 135 | 12930-63 | 103 | 14103-04 | 76 | 14145-20 | 77 | 14362-04 | 81 |
| 12303G20 | 51 | 12550-60 | 459 | 12635-26 | 135 | 12930-68 | 104 | 14103-06 | 76 | 14147-15 | 77 | 14362-06 | 81 |
| 12303G24 | 51 | 12550-62 | 458 | 12635-30 | 135 | 12930-69 | 104 | 14103-10 | 76 | 14147-20 | 77 | 14365-02 | 81 |
| 12303O16 | 51 | 12550-63 | 458 | 12635-35 | 135 | 12930-74 | 104 | 14103-15 | 76 | 14148-10 | 77 | 14365-04 | 81 |
| 12303O20 | 51 | 12550-64 | 458 | 12636-32 | 135 | 12930-77 | 104 | 14103-20 | 76 | 14148-15 | 77 | 14365-06 | 81 |
| 12303O24 | 51 | 12550-66 | 459 | 12640-14 | 124 | 12930-78 | 104 | 14103F02 | 569 | 14148-20 | 77 | 14402-00 | 83 |
| 12303W16 | 51 | 12550-68 | 458 | 12640-16 | 124 | 12931-51 | 104 | 14103F04 | 569 | 14151-10 | 78 | 14405-00 | 83 |
| 12303W20 | 51 | 12550-69 | 458 | 12640-18 | 124 | 12931-53 | 104 | 14103F06 | 569 | 14151-15 | 78 | 14407-00 | 83 |
| 12303W24 | 51 | 12550-70 | 458 | 12640-20 | 124 | 12940-02 | 130 | 14103F10 | 569 | 14151-20 | 78 | 14409-01 | 83 |

NUMERICAL INDEX INDICE NUMERICO NUMERISCH INDEX INDEX NUMERIQUE INDICE NUMERICO

| Cod. | pag. | Cod. | pag. | Cod. | pag. | Cod. | pag. | Cod. | pag. | Cod. | pag. | Cod. | pag. |
|----------|------|----------|------|----------|------|----------|------|----------|------|----------|------|----------|------|
| 14409-02 | 83 | 14591-00 | 85 | 14722-22 | 90 | 15100-04 | 94 | 15661-20 | 25 | 16139-10 | 32 | 16948-40 | 57 |
| 14480-20 | 353 | 14592-00 | 85 | 14722-33 | 90 | 15100-07 | 94 | 15661-24 | 25 | 16140-01 | 33 | 16948-45 | 57 |
| 14502-00 | 80 | 14595-00 | 85 | 14722-99 | 90 | 15100-AA | 94 | 15661-28 | 25 | 16140-02 | 33 | 16948-50 | 57 |
| 14502F00 | 569 | 14597-00 | 85 | 14725-00 | 90 | 15101-06 | 92 | 16101-16 | 54 | 16140-03 | 33 | 16948-60 | 57 |
| 14503-00 | 80 | 14598-00 | 85 | 14725-11 | 90 | 15101-10 | 92 | 16101-20 | 54 | 16140-04 | 33 | 16948-61 | 57 |
| 14503F00 | 569 | 14599-00 | 85 | 14725-22 | 90 | 15101-15 | 92 | 16101-24 | 54 | 16140-05 | 33 | 16961-16 | 55 |
| 14504-00 | 80 | 14661-20 | 86 | 14725-33 | 90 | 15101-20 | 92 | 16101-28 | 54 | 16302-02 | 82 | 16961-20 | 55 |
| 14504F00 | 569 | 14662-06 | 86 | 14725-99 | 90 | 15105-06 | 92 | 16101-32 | 54 | 16302-04 | 82 | 16961-24 | 55 |
| 14505-00 | 80 | 14662-10 | 86 | 14727-00 | 90 | 15105-10 | 92 | 16101-36 | 54 | 16302-06 | 82 | 16961-28 | 55 |
| 14505F00 | 569 | 14662-15 | 86 | 14727-11 | 90 | 15105-15 | 92 | 16101-40 | 54 | 16303-02 | 82 | 16961-32 | 55 |
| 14507-00 | 80 | 14662-20 | 86 | 14727-22 | 90 | 15105-20 | 92 | 16101-45 | 54 | 16303-04 | 82 | 16961-36 | 55 |
| 14507F00 | 569 | 14665-06 | 86 | 14727-33 | 90 | 15107-06 | 92 | 16101-50 | 54 | 16303-06 | 82 | 16961-40 | 55 |
| 14508-00 | 80 | 14665-10 | 86 | 14727-99 | 90 | 15107-10 | 92 | 16106-16 | 54 | 16305-02 | 82 | 16961-45 | 55 |
| 14508F00 | 569 | 14665-15 | 86 | 14728-00 | 90 | 15107-15 | 92 | 16106-20 | 54 | 16305-04 | 82 | 16961-50 | 55 |
| 14509-00 | 80 | 14665-20 | 86 | 14728-11 | 90 | 15107-20 | 92 | 16106-24 | 54 | 16305-06 | 82 | 16961-60 | 55 |
| 14509F00 | 569 | 14667-06 | 87 | 14728-22 | 90 | 15108-06 | 92 | 16106-28 | 54 | 16362-02 | 82 | 16965-40 | 57 |
| 14510-00 | 80 | 14667-10 | 87 | 14728-33 | 90 | 15108-10 | 92 | 16107-16 | 54 | 16362-04 | 82 | 16965-50 | 57 |
| 14510F00 | 569 | 14667-15 | 87 | 14728-99 | 90 | 15108-15 | 92 | 16107-20 | 54 | 16362-06 | 82 | 17610-01 | 130 |
| 14512-00 | 80 | 14667-20 | 87 | 14729-00 | 90 | 15108-20 | 92 | 16107-28 | 54 | 16363-02 | 82 | 17610-02 | 130 |
| 14515-00 | 80 | 14668-06 | 87 | 14729-11 | 90 | 15109-06 | 92 | 16107-32 | 54 | 16363-04 | 82 | 17610-05 | 130 |
| 14517-00 | 80 | 14668-10 | 87 | 14729-22 | 90 | 15109-10 | 92 | 16107-36 | 54 | 16363-06 | 82 | 17610-10 | 130 |
| 14518-00 | 80 | 14668-15 | 87 | 14729-33 | 90 | 15109-15 | 92 | 16107-40 | 54 | 16365-02 | 82 | 17621-01 | 379 |
| 14519-00 | 80 | 14668-20 | 87 | 14729-99 | 90 | 15109-20 | 92 | 16107-45 | 54 | 16365-04 | 82 | 17621-02 | 379 |
| 14522-00 | 80 | 14669-06 | 87 | 14730-00 | 90 | 15110-06 | 92 | 16107-50 | 54 | 16365-06 | 82 | 17621-09 | 379 |
| 14523-00 | 80 | 14669-10 | 87 | 14730-11 | 90 | 15110-10 | 92 | 16108-24 | 54 | 16712-22 | 57 | 17621-40 | 379 |
| 14525-00 | 80 | 14669-15 | 87 | 14730-22 | 90 | 15338-38 | 26 | 16108-28 | 54 | 16712-26 | 57 | 17621-44 | 379 |
| 14527-00 | 80 | 14669-20 | 87 | 14730-33 | 90 | 15339-36 | 26 | 16109-24 | 54 | 16712-30 | 57 | 17621-80 | 379 |
| 14528-00 | 80 | 14670-06 | 87 | 14730-99 | 90 | 15343-36 | 26 | 16109-28 | 54 | 16717-20 | 56 | 17621-90 | 379 |
| 14529-00 | 80 | 14670-10 | 87 | 14912-00 | 92 | 15403-16 | 26 | 16109-32 | 54 | 16717-24 | 56 | 17621-92 | 379 |
| 14532-00 | 80 | 14671-00 | 87 | 14915-00 | 92 | 15406-16 | 26 | 16109-36 | 54 | 16717-28 | 56 | 18000-16 | 161 |
| 14535-00 | 80 | 14672-00 | 87 | 14922-00 | 93 | 15406-20 | 26 | 16109-40 | 54 | 16717-32 | 56 | 18000-20 | 161 |
| 14537-00 | 80 | 14675-00 | 87 | 14922-11 | 93 | 15407-16 | 26 | 16109-45 | 54 | 16717-36 | 56 | 18000-23 | 161 |
| 14538-00 | 80 | 14677-00 | 87 | 14922-22 | 93 | 15407-20 | 26 | 16109-50 | 54 | 16717-40 | 56 | 18000-26 | 161 |
| 14539-00 | 80 | 14678-00 | 87 | 14922-33 | 93 | 15409-26 | 26 | 16113-20 | 56 | 16719-12 | 36 | 18000-26 | 177 |
| 14542-00 | 80 | 14679-00 | 87 | 14922-77 | 93 | 15409-30 | 26 | 16113-24 | 56 | 16910-14 | 57 | 18000-30 | 161 |
| 14543-00 | 80 | 14680-00 | 87 | 14922-99 | 93 | 15409-36 | 26 | 16113-28 | 56 | 16910-16 | 57 | 18000-30 | 177 |
| 14545-00 | 80 | 14682-00 | 87 | 14925-00 | 93 | 15415-03 | 26 | 16113-32 | 56 | 16910-18 | 57 | 18000-36 | 161 |
| 14547-00 | 80 | 14685-00 | 87 | 14925-11 | 93 | 15428-06 | 399 | 16113-36 | 56 | 16910-20 | 57 | 18000B16 | 161 |
| 14548-00 | 80 | 14687-00 | 87 | 14925-22 | 93 | 15430-11 | 26 | 16113-40 | 56 | 16924-20 | 132 | 18000B20 | 161 |
| 14549-00 | 80 | 14688-00 | 87 | 14925-33 | 93 | 15438-50 | 26 | 16114-20 | 54 | 16924-24 | 132 | 18000B23 | 161 |
| 14552-00 | 81 | 14689-00 | 87 | 14925-77 | 93 | 15606-09 | 29 | 16114-24 | 54 | 16924-28 | 132 | 18000B26 | 161 |
| 14555-00 | 81 | 14690-00 | 87 | 14925-99 | 93 | 15606-10 | 29 | 16114-28 | 54 | 16927-32 | 131 | 18000B30 | 161 |
| 14561-15 | 84 | 14691-00 | 87 | 14927-00 | 93 | 15606-12 | 29 | 16114-32 | 54 | 16927-36 | 131 | 18000G16 | 161 |
| 14561-20 | 84 | 14692-00 | 87 | 14927-11 | 93 | 15606-16 | 25 | 16114-36 | 54 | 16927-40 | 131 | 18000G20 | 161 |
| 14562-06 | 84 | 14695-00 | 87 | 14927-22 | 93 | 15606-20 | 25 | 16114-40 | 54 | 16927-45 | 131 | 18000G23 | 161 |
| 14562-10 | 84 | 14702-06 | 89 | 14927-33 | 93 | 15606-24 | 25 | 16115-36 | 54 | 16927-50 | 131 | 18000G26 | 161 |
| 14562-15 | 84 | 14702-10 | 89 | 14927-77 | 93 | 15606-28 | 25 | 16115-40 | 54 | 16929-36 | 54 | 18000G30 | 161 |
| 14562-20 | 84 | 14702-15 | 89 | 14927-99 | 93 | 15607-10 | 29 | 16115-45 | 54 | 16929-40 | 54 | 18000M16 | 161 |
| 14565-06 | 84 | 14702-20 | 89 | 14928-00 | 93 | 15607-16 | 25 | 16116-28 | 56 | 16938-36 | 54 | 18000M20 | 161 |
| 14565-10 | 84 | 14705-06 | 89 | 14928-11 | 93 | 15607-20 | 25 | 16116-32 | 56 | 16938-40 | 54 | 18000M23 | 161 |
| 14565-15 | 84 | 14705-10 | 89 | 14928-22 | 93 | 15607-24 | 25 | 16116-36 | 56 | 16938-45 | 54 | 18000M26 | 161 |
| 14565-20 | 84 | 14705-15 | 89 | 14928-33 | 93 | 15607-28 | 25 | 16116-40 | 56 | 16939-50 | 57 | 18000R16 | 161 |
| 14567-06 | 85 | 14705-20 | 89 | 14928-77 | 93 | 15608-20 | 25 | 16117-20 | 56 | 16939-60 | 57 | 18000R20 | 161 |
| 14567-10 | 85 | 14707-06 | 89 | 14928-99 | 93 | 15608-24 | 25 | 16117-24 | 56 | 16939-70 | 57 | 18000R23 | 161 |
| 14567-15 | 85 | 14707-10 | 89 | 14929-00 | 93 | 15608-28 | 25 | 16117-28 | 56 | 16939-80 | 57 | 18000R26 | 161 |
| 14567-20 | 85 | 14707-15 | 89 | 14929-11 | 93 | 15609-20 | 25 | 16117-32 | 56 | 16940-28 | 226 | 18000R30 | 161 |
| 14568-06 | 85 | 14707-20 | 89 | 14929-22 | 93 | 15609-24 | 25 | 16117-36 | 56 | 16940-32 | 226 | 18000W20 | 161 |
| 14568-10 | 85 | 14708-06 | 89 | 14929-33 | 93 | 15609-28 | 25 | 16117-40 | 56 | 16940-36 | 226 | 18000W26 | 161 |
| 14568-15 | 85 | 14708-10 | 89 | 14929-77 | 93 | 15611-12 | 29 | 16118-24 | 56 | 16940-40 | 226 | 18000W30 | 161 |
| 14568-20 | 85 | 14708-15 | 89 | 14929-99 | 93 | 15614-12 | 29 | 16120-24 | 55 | 16941-40 | 57 | 18000Y16 | 161 |
| 14569-06 | 85 | 14708-20 | 89 | 14930-00 | 93 | 15614-20 | 25 | 16120-28 | 55 | 16941-45 | 57 | 18000Y20 | 161 |
| 14569-10 | 85 | 14709-06 | 89 | 14930-11 | 93 | 15614-24 | 25 | 16120-32 | 55 | 16941-50 | 57 | 18000Y23 | 161 |
| 14569-15 | 85 | 14709-10 | 89 | 14930-22 | 93 | 15614-28 | 25 | 16120-36 | 55 | 16941-61 | 57 | 18000Y26 | 161 |
| 14569-20 | 85 | 14709-15 | 89 | 14930-33 | 93 | 15614-32 | 25 | 16120-40 | 55 | 16943-40 | 57 | 18002-18 | 162 |
| 14570-06 | 85 | 14709-20 | 89 | 14930-77 | 93 | 15615-12 | 29 | 16127-16 | 55 | 16943-45 | 57 | 18002-18 | 177 |
| 14570-10 | 85 | 14710-06 | 89 | 14930-99 | 93 | 15615-16 | 29 | 16127-20 | 55 | 16943-50 | 57 | 18002-20 | 162 |
| 14571-00 | 85 | 14710-10 | 89 | 14942-99 | 92 | 15615-20 | 25 | 16127-32 | 55 | 16943-60 | 57 | 18002-22 | 162 |
| 14572-00 | 85 | 14712-00 | 89 | 14945-99 | 92 | 15615-24 | 25 | 16127-36 | 55 | 16943-61 | 57 | 18002-26 | 162 |
| 14575-00 | 85 | 14715-00 | 89 | 14947-99 | 92 | 15615-28 | 25 | 16127-40 | 55 | 16944-45 | 57 | 18002-26 | 177 |
| 14577-00 | 85 | 14717-00 | 89 | 14958-01 | 345 | 15615-32 | 25 | 16134-12 | 32 | 16944-50 | 57 | 18002-30 | 162 |
| 14578-00 | 85 | 14718-00 | 89 | 14958-02 | 345 | 15638-17 | 29 | 16135-12 | 32 | 16944-60 | 57 | 18002-36 | 162 |
| 14579-00 | 85 | 14719-00 | 89 | 15100-01 | 94 | 15643-12 | 29 | 16136-10 | 32 | 16947-50 | 57 | 18002B26 | 162 |
| 14580-00 | 85 | 14722-00 | 90 | 15100-02 | 94 | 15661-10 | 29 | 16137-10 | 32 | 16947-60 | 57 | 18002R18 | 162 |
| 14585-00 | 85 | 14722-11 | 90 | 15100-03 | 94 | 15661-12 | 29 | 16138-10 | 32 | 16947-61 | 57 | 18002R20 | 162 |

| Cod. | pag. | Cod. | pag. | Cod. | pag. | Cod. | pag. | Cod. | pag. | Cod. | pag. | Cod. | pag. |
|----------|------|----------|------|----------|------|----------|------|----------|------|----------|------|----------|------|
| 18002R22 | 162 | 18015-27 | 165 | 18028W36 | 168 | 18132-KA | 509 | 18166-KE | 510 | 18221G21 | 169 | 18323-00 | 294 |
| 18002R26 | 162 | 18015B18 | 165 | 18028Y25 | 168 | 18132-KE | 510 | 18166-KP | 510 | 18221M17 | 169 | 18324-00 | 294 |
| 18002R30 | 162 | 18015B22 | 165 | 18028Y30 | 168 | 18132-KP | 573 | 18166-KU | 510 | 18221M19 | 169 | 18324-10 | 107 |
| 18002R36 | 162 | 18015R22 | 165 | 18029-25 | 167 | 18132-KQ | 573 | 18166U24 | 504 | 18221M21 | 169 | 18324-10 | 294 |
| 18002Y18 | 162 | 18015Y18 | 165 | 18029-30 | 167 | 18132-KU | 510 | 18166U36 | 504 | 18221R17 | 170 | 18324F10 | 570 |
| 18002Y26 | 162 | 18015Y27 | 165 | 18029-36 | 167 | 18132U54 | 504 | 18166U40 | 504 | 18221R19 | 170 | 18325-01 | 215 |
| 18002Y30 | 162 | 18016-14 | 165 | 18029W30 | 167 | 18132U55 | 505 | 18168A24 | 504 | 18221R21 | 170 | 18325-02 | 215 |
| 18002Y36 | 162 | 18016-16 | 165 | 18029W36 | 167 | 18136A33 | 505 | 18168E24 | 504 | 18221Y17 | 170 | 18325-03 | 215 |
| 18005-22 | 161 | 18016-16 | 177 | 18030-26 | 168 | 18136A34 | 505 | 18168-GA | 508 | 18221Y19 | 170 | 18341-KE | 510 |
| 18005-27 | 161 | 18016B14 | 165 | 18030-31 | 168 | 18136A40 | 505 | 18168U24 | 504 | 18221Y21 | 170 | 18341-KU | 510 |
| 18005-32 | 161 | 18016B16 | 165 | 18030-36 | 168 | 18136A41 | 505 | 18172-54 | 502 | 18222-18 | 171 | 18353-17 | 499 |
| 18005B22 | 162 | 18016R14 | 165 | 18030W26 | 168 | 18136E33 | 505 | 18172A54 | 504 | 18224-28 | 170 | 18353-AA | 574 |
| 18005B27 | 162 | 18016R16 | 165 | 18030W31 | 168 | 18136E34 | 505 | 18172A55 | 503 | 18224B28 | 170 | 18353-BB | 574 |
| 18005B32 | 162 | 18016W16 | 165 | 18030W36 | 168 | 18136E40 | 505 | 18172-AF | 574 | 18224R28 | 170 | 18353-CA | 574 |
| 18005G22 | 162 | 18016Y14 | 166 | 18099-15 | 177 | 18136E41 | 505 | 18172-AG | 574 | 18224Y28 | 170 | 18353-DB | 574 |
| 18005G27 | 162 | 18016Y16 | 166 | 18100-16 | 158 | 18136-EA | 509 | 18172E54 | 504 | 18225-28 | 170 | 18353-VA | 574 |
| 18005G32 | 162 | 18017-14 | 166 | 18100-20 | 158 | 18136-EB | 509 | 18172E55 | 503 | 18225R28 | 170 | 18501-01 | 301 |
| 18005R22 | 162 | 18017-16 | 166 | 18100-20 | 178 | 18136-KA | 509 | 18172U54 | 504 | 18226-17 | 172 | 18501-02 | 301 |
| 18005R27 | 162 | 18017-18 | 166 | 18100-24 | 158 | 18136-KE | 510 | 18172U55 | 503 | 18226B17 | 172 | 18501-03 | 301 |
| 18005R32 | 162 | 18017B16 | 166 | 18100-24 | 177 | 18136-KP | 573 | 18176-30 | 502 | 18226G17 | 172 | 18501-04 | 301 |
| 18005Y22 | 162 | 18017R16 | 166 | 18100-30 | 158 | 18136-KQ | 573 | 18176-36 | 502 | 18226R17 | 172 | 18501-05 | 301 |
| 18005Y27 | 162 | 18017Y16 | 166 | 18100-30 | 177 | 18136-KR | 573 | 18176-40 | 502 | 18226W17 | 172 | 18502-18 | 301 |
| 18005Y32 | 162 | 18018-11 | 166 | 18100-36 | 158 | 18136-KU | 510 | 18176A30 | 503 | 18226Y17 | 172 | 18503-12 | 301 |
| 18006-20 | 163 | 18018R11 | 166 | 18102-16 | 158 | 18136U33 | 505 | 18176A36 | 503 | 18230-13 | 159 | 18504-15 | 301 |
| 18006-25 | 163 | 18018Y11 | 166 | 18102-16 | 178 | 18136U34 | 505 | 18176A40 | 503 | 18230-17 | 159 | 18509-01 | 119 |
| 18006-30 | 163 | 18019-12 | 166 | 18102-20 | 158 | 18136U40 | 505 | 18176-AE | 574 | 18230-17 | 177 | 18509-02 | 119 |
| 18006-36 | 163 | 18019-14 | 166 | 18102-26 | 158 | 18136U41 | 505 | 18176-AF | 574 | 18231-13 | 159 | 18509-03 | 119 |
| 18006B20 | 163 | 18019-16 | 166 | 18102-30 | 158 | 18162-54 | 502 | 18176-AH | 574 | 18235-26 | 172 | 18510-07 | 119 |
| 18006B25 | 163 | 18019-18 | 166 | 18103-18 | 158 | 18162A54 | 504 | 18176E30 | 503 | 18235-26 | 178 | 18510F07 | 570 |
| 18006B30 | 163 | 18019-20 | 166 | 18104-18 | 158 | 18162A55 | 503 | 18176E36 | 503 | 18235-30 | 172 | 18511-15 | 118 |
| 18006G20 | 163 | 18019R12 | 166 | 18106-15 | 158 | 18162-AA | 508 | 18176E40 | 503 | 18235-30 | 177 | 18511F15 | 570 |
| 18006G25 | 163 | 18019R16 | 166 | 18106-20 | 158 | 18162-AF | 573 | 18176I30 | 502 | 18235B30 | 172 | 18512-15 | 118 |
| 18006R25 | 163 | 18019R20 | 166 | 18106-20 | 178 | 18162-AG | 573 | 18176I36 | 502 | 18235G30 | 172 | 18513-14 | 119 |
| 18006R30 | 163 | 18020-23 | 166 | 18106-25 | 158 | 18162E54 | 504 | 18176I40 | 502 | 18235R30 | 172 | 18513F14 | 570 |
| 18006Y20 | 163 | 18020B23 | 166 | 18106-25 | 178 | 18162E55 | 503 | 18176U36 | 503 | 18235W30 | 172 | 18514-17 | 119 |
| 18006Y25 | 163 | 18020R23 | 166 | 18106-30 | 158 | 18162-KE | 510 | 18176U40 | 503 | 18235Y30 | 172 | 18514-18 | 119 |
| 18006Y30 | 163 | 18021-18 | 166 | 18109-26 | 158 | 18162-KU | 510 | 18190-09 | 178 | 18236-30 | 172 | 18514-18 | 171 |
| 18007-25 | 163 | 18021B18 | 166 | 18109-26 | 178 | 18162-RA | 508 | 18190-AA | 574 | 18237-26 | 172 | 18515-16 | 118 |
| 18007-30 | 163 | 18021R18 | 166 | 18109-30 | 158 | 18162-RB | 561 | 18192-09 | 178 | 18251-01 | 172 | 18516-24 | 119 |
| 18007-36 | 163 | 18022-12 | 166 | 18110-26 | 158 | 18162-RB | 508 | 18199-19 | 177 | 18251-02 | 173 | 18517-24 | 119 |
| 18007G30 | 163 | 18023-11 | 166 | 18110-30 | 158 | 18162U54 | 504 | 18201-36 | 171 | 18255-00 | 177 | 18518-22 | 119 |
| 18008-20 | 163 | 18024-08 | 167 | 18110-36 | 158 | 18162U55 | 503 | 18203-26 | 171 | 18255-00 | 177 | 18518-26 | 119 |
| 18008-26 | 163 | 18024-11 | 167 | 18111-30 | 158 | 18166-24 | 502 | 18205-10 | 171 | 18261-00 | 173 | 18518-30 | 119 |
| 18008-30 | 163 | 18024-11 | 177 | 18112-30 | 158 | 18166-30 | 502 | 18205-12 | 171 | 18263-00 | 173 | 18519-15 | 119 |
| 18008-36 | 163 | 18024B08 | 167 | 18112-30 | 177 | 18166-36 | 502 | 18206-09 | 171 | 18270-22 | 173 | 18519-22 | 119 |
| 18008B30 | 163 | 18024B11 | 167 | 18114-20 | 158 | 18166-40 | 502 | 18207-15 | 171 | 18271-00 | 174 | 18519-26 | 119 |
| 18008R26 | 163 | 18024G08 | 167 | 18115-20 | 159 | 18166A24 | 503 | 18209-06 | 171 | 18271-00 | 178 | 18519-26 | 177 |
| 18008R30 | 163 | 18024G11 | 167 | 18115-20 | 177 | 18166A30 | 503 | 18215-13 | 171 | 18272-00 | 174 | 18519-30 | 119 |
| 18008R36 | 163 | 18024M08 | 167 | 18115-25 | 159 | 18166A36 | 503 | 18215-21 | 171 | 18273-00 | 174 | 18519-35 | 119 |
| 18008Y30 | 164 | 18024M11 | 167 | 18116-14 | 159 | 18166A40 | 503 | 18217-12 | 167 | 18274-00 | 174 | 18520-04 | 119 |
| 18009-25 | 164 | 18024R08 | 167 | 18116-14 | 177 | 18166-AA | 508 | 18220-18 | 170 | 18275-00 | 173 | 18520-06 | 119 |
| 18009-30 | 164 | 18024R11 | 167 | 18116-18 | 159 | 18166-AB | 508 | 18220-20 | 170 | 18276-00 | 174 | 18520-08 | 119 |
| 18009-30 | 177 | 18024W08 | 167 | 18122-12 | 159 | 18166-AC | 508 | 18220-22 | 170 | 18276-00 | 177 | 18520-10 | 119 |
| 18009-36 | 164 | 18024W11 | 167 | 18123-11 | 159 | 18166-AD | 574 | 18220-26 | 170 | 18276-00 | 294 | 18520-12 | 119 |
| 18009B25 | 164 | 18024Y08 | 167 | 18124-09 | 159 | 18166-AE | 574 | 18220B18 | 170 | 18277-00 | 140 | 18520-15 | 301 |
| 18009R25 | 164 | 18026-07 | 167 | 18124-09 | 178 | 18166-AF | 574 | 18220B20 | 170 | 18278-00 | 173 | 19701-00 | 150 |
| 18009W25 | 164 | 18026-07 | 177 | 18125-07 | 159 | 18166-AH | 574 | 18220B22 | 170 | 18279-14 | 173 | 19702-00 | 149 |
| 18009W30 | 164 | 18026B07 | 167 | 18125-10 | 159 | 18166-AM | 508 | 18220B26 | 170 | 18280-10 | 176 | 19705-00 | 149 |
| 18009Y25 | 164 | 18026G07 | 167 | 18125-10 | 177 | 18166E24 | 504 | 18220R18 | 170 | 18280-16 | 176 | 19706-00 | 149 |
| 18009Y30 | 164 | 18026M07 | 167 | 18126-07 | 159 | 18166E30 | 504 | 18220R20 | 170 | 18280-22 | 176 | 19709-00 | 149 |
| 18010-25 | 164 | 18028-21 | 168 | 18126-07 | 177 | 18166E36 | 504 | 18220R22 | 170 | 18281-24 | 176 | 19810-00 | 147 |
| 18010-30 | 164 | 18028-25 | 168 | 18128-20 | 159 | 18166E40 | 504 | 18220R26 | 170 | 18282-18 | 176 | 19810-AA | 574 |
| 18010-36 | 164 | 18028-30 | 168 | 18128-20 | 178 | 18166-EB | 509 | 18220Y18 | 170 | 18282-19 | 176 | 19810-AB | 574 |
| 18010Y30 | 164 | 18028-30 | 177 | 18128-24 | 159 | 18166-EC | 509 | 18220Y20 | 170 | 18282-22 | 176 | 19901-35 | 514 |
| 18011-32 | 164 | 18028-36 | 168 | 18128-24 | 178 | 18166-ED | 509 | 18220Y22 | 170 | 18283-27 | 176 | 19901-40 | 514 |
| 18012-32 | 164 | 18028B30 | 168 | 18128-30 | 159 | 18166-EG | 509 | 18220Y26 | 170 | 18283-33 | 176 | 19901-47 | 514 |
| 18012B32 | 164 | 18028F21 | 570 | 18128-30 | 177 | 18166-EH | 509 | 18221-17 | 169 | 18284-21 | 176 | 19902-38 | 514 |
| 18013-30 | 164 | 18028F25 | 570 | 18132A54 | 504 | 18166-EI | 509 | 18221-19 | 169 | 18284-27 | 176 | 32936-05 | 405 |
| 18013-36 | 164 | 18028F30 | 570 | 18132A55 | 505 | 18166-EJ | 509 | 18221-21 | 169 | 18284-30 | 176 | 41200-01 | 375 |
| 18013G36 | 165 | 18028F36 | 570 | 18132-AE | 510 | 18166-EL | 509 | 18221B17 | 169 | 18284-33 | 176 | 41200-02 | 375 |
| 18013W30 | 165 | 18028M25 | 168 | 18132-AU | 510 | 18166-EM | 509 | 18221B19 | 169 | 18301-01 | 294 | 41200-03 | 375 |
| 18013W36 | 165 | 18028W21 | 168 | 18132E54 | 504 | 18166I30 | 502 | 18221B21 | 169 | 18301-02 | 295 | 41200-04 | 375 |
| 18015-18 | 165 | 18028W25 | 168 | 18132E55 | 505 | 18166I36 | 502 | 18221G17 | 169 | 18302-01 | 295 | 41200-05 | 375 |
| 18015-22 | 165 | 18028W30 | 168 | 18132-FB | 509 | 18166I40 | 502 | 18221G19 | 169 | 18302-02 | 295 | 41200-06 | 375 |

NUMERICAL INDEX INDICE NUMERICO NUMERISCH INDEX INDEX NUMERIQUE INDICE NUMERICO

| Cod. | pag. | Cod. | pag. | Cod. | pag. | Cod. | pag. | Cod. | pag. | Cod. | pag. | Cod. | pag. |
|----------|------|----------|------|----------|------|----------|------|----------|------|----------|------|----------|------|
| 41200-07 | 375 | 41209-04 | 491 | 41414-31 | 310 | 41458-50 | 325 | 41472-36 | 322 | 41491C03 | 334 | 41507B03 | 403 |
| 41200-08 | 375 | 41209-05 | 491 | 41414-36 | 310 | 41458-51 | 325 | 41472-37 | 323 | 41491C04 | 334 | 41507B04 | 403 |
| 41200-09 | 375 | 41209-06 | 491 | 41415-11 | 492 | 41459-10 | 324 | 41472-38 | 323 | 41491C05 | 334 | 41507C03 | 403 |
| 41200-10 | 375 | 41210-01 | 34 | 41415-11 | 482 | 41460-05 | 324 | 41472-41 | 323 | 41491C06 | 335 | 41507C04 | 403 |
| 41200-11 | 375 | 41210-03 | 34 | 41416-18 | 313 | 41460-10 | 324 | 41472-42 | 323 | 41491G00 | 334 | 41508C12 | 404 |
| 41200-13 | 375 | 41210-05 | 34 | 41416-18 | 395 | 41461-07 | 339 | 41472-43 | 316 | 41491G01 | 334 | 41509B20 | 404 |
| 41200-14 | 375 | 41210-07 | 34 | 41416-20 | 312 | 41461A07 | 338 | 41472-44 | 317 | 41491G02 | 334 | 41510-08 | 405 |
| 41200-15 | 375 | 41210-08 | 34 | 41416-24 | 312 | 41461B07 | 339 | 41472-45 | 317 | 41491G03 | 334 | 41511-00 | 405 |
| 41200-16 | 375 | 41210-10 | 34 | 41416-25 | 312 | 41461C07 | 339 | 41472-46 | 317 | 41491G04 | 334 | 41511-20 | 405 |
| 41200-17 | 375 | 41210-12 | 34 | 41416-28 | 312 | 41461-C4 | 362 | 41472-47 | 323 | 41491G05 | 334 | 41511-30 | 405 |
| 41200-18 | 376 | 41210-13 | 34 | 41416-32 | 312 | 41461-C5 | 363 | 41472-48 | 323 | 41491G06 | 335 | 41512-50 | 347 |
| 41200-32 | 376 | 41210-14 | 34 | 41418-11 | 482 | 41461-C6 | 363 | 41472-50 | 323 | 41492-00 | 358 | 41513-13 | 347 |
| 41200-33 | 376 | 41220-01 | 484 | 41418-12 | 482 | 41461G07 | 339 | 41473-31 | 316 | 41492B00 | 358 | 41513A20 | 348 |
| 41200-34 | 376 | 41220-02 | 484 | 41418B11 | 485 | 41461-G4 | 362 | 41473-39 | 316 | 41492C00 | 358 | 41513B20 | 348 |
| 41200-36 | 376 | 41220-03 | 484 | 41418B12 | 485 | 41461-G5 | 363 | 41473-44 | 316 | 41492G00 | 358 | 41513C20 | 348 |
| 41200-40 | 376 | 41220-04 | 484 | 41419-12 | 482 | 41461-G6 | 363 | 41473-50 | 316 | 41493A00 | 327 | 41513G20 | 348 |
| 41200-41 | 376 | 41220-05 | 485 | 41420-24 | 469 | 41463-01 | 329 | 41473-56 | 316 | 41493B00 | 328 | 41514-05 | 340 |
| 41200-46 | 376 | 41220-06 | 485 | 41420-30 | 311 | 41463-02 | 329 | 41473-62 | 316 | 41493C00 | 328 | 41514-10 | 340 |
| 41200-47 | 376 | 41220-07 | 485 | 41420-31 | 312 | 41463A00 | 330 | 41473-66 | 316 | 41493-C2 | 361 | 41514-C5 | 362 |
| 41200-48 | 376 | 41220-11 | 485 | 41422-25 | 313 | 41463A05 | 329 | 41474-00 | 316 | 41493G00 | 328 | 41514-G5 | 362 |
| 41200-49 | 376 | 41220-12 | 485 | 41422-27 | 312 | 41463A30 | 330 | 41474-02 | 316 | 41493-G2 | 361 | 41515-03 | 346 |
| 41200-50 | 376 | 41220-24 | 485 | 41422-30 | 313 | 41463A50 | 330 | 41475-00 | 315 | 41494A00 | 327 | 41515-05 | 346 |
| 41200-51 | 376 | 41311-AA | 398 | 41422-38 | 312 | 41463B05 | 329 | 41475-01 | 315 | 41494B00 | 328 | 41515-06 | 346 |
| 41200-52 | 376 | 41311-AA | 575 | 41422-42 | 312 | 41463C00 | 330 | 41475-03 | 315 | 41494C00 | 328 | 41515-07 | 346 |
| 41200-53 | 376 | 41312-00 | 398 | 41425-AA | 494 | 41463C30 | 330 | 41475-04 | 315 | 41494-C2 | 361 | 41515-08 | 346 |
| 41200-54 | 376 | 41313-00 | 399 | 41430-11 | 477 | 41463C50 | 330 | 41475-05 | 315 | 41494-C3 | 361 | 41515-09 | 346 |
| 41200-55 | 376 | 41314-00 | 399 | 41431-08 | 315 | 41463G05 | 329 | 41475-20 | 315 | 41494G00 | 328 | 41515-10 | 346 |
| 41200-56 | 376 | 41315-02 | 399 | 41431-12 | 315 | 41463M05 | 329 | 41476-50 | 316 | 41494-G2 | 361 | 41515-18 | 347 |
| 41200-57 | 376 | 41317-20 | 399 | 41436-11 | 476 | 41464-09 | 339 | 41477-50 | 340 | 41494-G3 | 361 | 41515-19 | 346 |
| 41200-58 | 376 | 41318-00 | 398 | 41436-12 | 476 | 41464A09 | 338 | 41478-35 | 340 | 41495-08 | 334 | 41515-20 | 347 |
| 41200-59 | 376 | 41320-25 | 369 | 41442-03 | 495 | 41464B09 | 339 | 41478-50 | 340 | 41495-10 | 334 | 41515-21 | 347 |
| 41200-60 | 376 | 41321-40 | 369 | 41443-AE | 575 | 41464C09 | 339 | 41479-05 | 340 | 41496-40 | 405 | 41515-22 | 346 |
| 41200-61 | 376 | 41321-44 | 369 | 41445-01 | 469 | 41464G09 | 339 | 41479-11 | 340 | 41497-05 | 331 | 41516-20 | 402 |
| 41200-62 | 376 | 41322-19 | 369 | 41445-02 | 469 | 41465-10 | 345 | 41479-AA | 340 | 41497A05 | 327 | 41516C20 | 402 |
| 41200-63 | 376 | 41322-25 | 369 | 41445-05 | 469 | 41467A08 | 338 | 41480-03 | 339 | 41497B05 | 331 | 41516G20 | 402 |
| 41200-64 | 376 | 41322-31 | 369 | 41445-06 | 469 | 41467B08 | 339 | 41480-05 | 339 | 41497C05 | 331 | 41518-00 | 401 |
| 41202-01 | 304 | 41325-20 | 369 | 41445-07 | 469 | 41467C08 | 339 | 41480-07 | 339 | 41497G05 | 331 | 41518-01 | 401 |
| 41202-02 | 304 | 41325-30 | 369 | 41445-09 | 469 | 41467-C5 | 362 | 41480A05 | 338 | 41498A00 | 327 | 41518-02 | 401 |
| 41203-01 | 304 | 41325-40 | 369 | 41445-11 | 311 | 41467G08 | 339 | 41480B05 | 339 | 41498B00 | 328 | 41518A12 | 347 |
| 41203-11 | 304 | 41326-26 | 369 | 41445-22 | 468 | 41467-G5 | 362 | 41480C05 | 339 | 41498C00 | 328 | 41518B12 | 347 |
| 41204-01 | 373 | 41326-30 | 370 | 41445-26 | 468 | 41468-20 | 315 | 41480-C8 | 363 | 41498G00 | 328 | 41518C12 | 347 |
| 41204-02 | 373 | 41326-33 | 370 | 41445-30 | 468 | 41468-24 | 315 | 41480G05 | 339 | 41499-08 | 405 | 41518G12 | 347 |
| 41204-03 | 373 | 41326-36 | 370 | 41446-18 | 468 | 41469-20 | 315 | 41480-G8 | 363 | 41499B00 | 328 | 41520-08 | 130 |
| 41204-04 | 374 | 41326-40 | 370 | 41446-23 | 468 | 41469-24 | 315 | 41481-02 | 340 | 41499C00 | 328 | 41520-12 | 130 |
| 41204-05 | 374 | 41326-42 | 370 | 41447-02 | 492 | 41470A00 | 331 | 41481-03 | 340 | 41499G00 | 328 | 41520-16 | 130 |
| 41204-06 | 374 | 41326-43 | 370 | 41447-05 | 492 | 41470A03 | 331 | 41483-04 | 340 | 41500-00 | 357 | 41520-24 | 130 |
| 41204-07 | 374 | 41327-01 | 368 | 41447-38 | 465 | 41470C00 | 331 | 41484-05 | 339 | 41500-AA | 357 | 41521-01 | 366 |
| 41204-08 | 374 | 41327-02 | 368 | 41448-06 | 495 | 41470C03 | 331 | 41484A05 | 338 | 41501-20 | 403 | 41521-02 | 366 |
| 41204-09 | 374 | 41327-03 | 368 | 41448-10 | 495 | 41471-00 | 315 | 41484B05 | 339 | 41501-23 | 403 | 41522-14 | 364 |
| 41204-10 | 374 | 41327-04 | 368 | 41448-25 | 495 | 41471-12 | 315 | 41484C05 | 339 | 41501-40 | 403 | 41523-08 | 364 |
| 41204-11 | 374 | 41327-05 | 368 | 41448-40 | 495 | 41471-15 | 315 | 41484-C3 | 361 | 41502-20 | 402 | 41523-09 | 364 |
| 41204-12 | 374 | 41327-06 | 369 | 41450-AA | 324 | 41471-17 | 315 | 41484G05 | 339 | 41503-00 | 345 | 41523G08 | 365 |
| 41205-01 | 366 | 41327-07 | 369 | 41451-05 | 324 | 41472-01 | 317 | 41484-G3 | 361 | 41503-21 | 345 | 41523G09 | 365 |
| 41205-02 | 366 | 41327-08 | 369 | 41451-10 | 324 | 41472-04 | 316 | 41486-00 | 315 | 41503-22 | 345 | 41524-04 | 364 |
| 41205-03 | 366 | 41327-09 | 369 | 41452N10 | 305 | 41472-07 | 316 | 41486-01 | 315 | 41503C21 | 345 | 41524-09 | 364 |
| 41205-04 | 366 | 41327-10 | 369 | 41452N16 | 305 | 41472-08 | 316 | 41486-08 | 315 | 41503G21 | 345 | 41524-10 | 365 |
| 41205-05 | 366 | 41380-01 | 155 | 41453-11 | 344 | 41472-12 | 307 | 41486-12 | 315 | 41504-09 | 404 | 41524-11 | 365 |
| 41205-06 | 366 | 41380-02 | 155 | 41453-AA | 345 | 41472-13 | 307 | 41486-15 | 315 | 41504-10 | 404 | 41524-12 | 365 |
| 41205-07 | 366 | 41390-00 | 407 | 41454-01 | 345 | 41472-14 | 319 | 41487-12 | 315 | 41504-11 | 404 | 41524C10 | 365 |
| 41205-08 | 366 | 41391-08 | 407 | 41454-99 | 345 | 41472-15 | 319 | 41487-15 | 315 | 41504-19 | 404 | 41524C11 | 365 |
| 41205-09 | 366 | 41394-02 | 406 | 41455-BC | 324 | 41472-16 | 318 | 41487-17 | 315 | 41504B19 | 404 | 41524C12 | 365 |
| 41205-10 | 367 | 41400-AA | 494 | 41455-CA | 325 | 41472-17 | 318 | 41489-20 | 315 | 41504G20 | 404 | 41525-00 | 306 |
| 41206-01 | 369 | 41400-AB | 575 | 41455-CB | 325 | 41472-18 | 318 | 41490-00 | 333 | 41504W20 | 404 | 41525-01 | 306 |
| 41206-02 | 369 | 41402-AA | 575 | 41455T55 | 324 | 41472-19 | 319 | 41490-01 | 333 | 41505-00 | 403 | 41526-01 | 129 |
| 41206-03 | 309 | 41403-01 | 96 | 41456-02 | 344 | 41472-20 | 318 | 41490-AA | 333 | 41505-17 | 403 | 41526-02 | 129 |
| 41206-04 | 367 | 41403-02 | 96 | 41457-00 | 345 | 41472-21 | 318 | 41490B00 | 333 | 41505-19 | 403 | 41526-05 | 129 |
| 41206-05 | 498 | 41403-03 | 96 | 41458-02 | 324 | 41472-22 | 318 | 41490B01 | 333 | 41505-20 | 403 | 41526-06 | 129 |
| 41207-02 | 370 | 41403-04 | 96 | 41458-05 | 324 | 41472-23 | 319 | 41490C00 | 333 | 41505B15 | 404 | 41526-B1 | 129 |
| 41207-03 | 370 | 41405-AA | 494 | 41458-10 | 324 | 41472-24 | 319 | 41490C01 | 333 | 41506-11 | 474 | 41526-B2 | 129 |
| 41208-02 | 309 | 41405-AB | 575 | 41458-11 | 325 | 41472-25 | 307 | 41490G00 | 333 | 41506-19 | 487 | 41526-B3 | 129 |
| 41208-06 | 309 | 41412-11 | 492 | 41458-21 | 325 | 41472-32 | 313 | 41490G01 | 333 | 41506B11 | 474 | 41526-G1 | 129 |
| 41209-01 | 491 | 41413-30 | 310 | 41458-23 | 324 | 41472-33 | 322 | 41491C00 | 334 | 41506B19 | 487 | 41526-G2 | 129 |
| 41209-02 | 491 | 41414-21 | 310 | 41458-24 | 324 | 41472-34 | 322 | 41491C01 | 334 | 41506C11 | 474 | 41526-G3 | 129 |
| 41209-03 | 491 | 41414-30 | 309 | 41458-25 | 325 | 41472-35 | 322 | 41491C02 | 334 | 41506C19 | 487 | 41526-R1 | 129 |

| Cod. | pag. | Cod. | pag. | Cod. | pag. | Cod. | pag. | Cod. | pag. | Cod. | pag. | Cod. | pag. |
|----------|------|----------|------|----------|------|----------|------|----------|------|----------|------|----------|------|
| 41526-R2 | 129 | 41589-07 | 387 | 41605-30 | 335 | 41651-40 | 476 | 41707-45 | 59 | 41752-12 | 301 | 41807-12 | 499 |
| 41526-R3 | 129 | 41589-08 | 386 | 41605A03 | 335 | 41651-45 | 476 | 41707-50 | 59 | 41752-24 | 301 | 41808-04 | 500 |
| 41527-10 | 364 | 41589-14 | 386 | 41605A27 | 335 | 41651-50 | 476 | 41708-32 | 59 | 41753D30 | 210 | 41808B07 | 500 |
| 41527-11 | 364 | 41589-16 | 386 | 41605A30 | 335 | 41651-55 | 476 | 41708-36 | 59 | 41753D32 | 210 | 41808B90 | 500 |
| 41527-12 | 364 | 41589-20 | 386 | 41605B03 | 336 | 41651-60 | 476 | 41708-40 | 59 | 41753D53 | 210 | 41809-09 | 509 |
| 41527-13 | 364 | 41589-22 | 387 | 41605B27 | 335 | 41651-65 | 476 | 41708-45 | 59 | 41753D60 | 210 | 41810-04 | 498 |
| 41527G10 | 365 | 41589-25 | 387 | 41605B30 | 335 | 41654-80 | 476 | 41708-50 | 59 | 41755-11 | 300 | 41810-09 | 498 |
| 41527G11 | 365 | 41589-29 | 387 | 41605C03 | 336 | 41654-99 | 476 | 41717-60 | 59 | 41756-30 | 209 | 41810B04 | 498 |
| 41527G12 | 365 | 41589-30 | 387 | 41605C30 | 335 | 41659-06 | 226 | 41719-36 | 58 | 41756-32 | 209 | 41860-36 | 359 |
| 41527G13 | 365 | 41589-31 | 387 | 41605G03 | 335 | 41659-07 | 226 | 41719-40 | 58 | 41756-53 | 209 | 41860-43 | 359 |
| 41528-21 | 129 | 41589-34 | 387 | 41605G27 | 335 | 41659-08 | 226 | 41720-18 | 56 | 41756-60 | 209 | 41860-47 | 359 |
| 41528-22 | 129 | 41589-35 | 387 | 41605G30 | 335 | 41660-10 | 224 | 41720-20 | 56 | 41758-53 | 274 | 41861-44 | 359 |
| 41529-05 | 391 | 41589-37 | 387 | 41606-00 | 344 | 41660-15 | 224 | 41720-24 | 56 | 41758-60 | 274 | 41862B11 | 359 |
| 41530-05 | 391 | 41589-50 | 388 | 41606-01 | 344 | 41670-06 | 123 | 41720-28 | 56 | 41758-65 | 274 | 41862B53 | 359 |
| 41530-07 | 391 | 41589-58 | 387 | 41606-02 | 344 | 41670-09 | 123 | 41720-30 | 56 | 41758-85 | 274 | 41862C11 | 359 |
| 41530-11 | 391 | 41589-59 | 387 | 41606-22 | 344 | 41670-AA | 123 | 41720-32 | 56 | 41759-01 | 273 | 41862C53 | 359 |
| 41532B15 | 365 | 41589-99 | 388 | 41607-00 | 306 | 41670-AB | 123 | 41727-28 | 298 | 41759-01 | 273 | 41862G11 | 359 |
| 41532B23 | 365 | 41589-AA | 388 | 41608-03 | 357 | 41671-11 | 123 | 41727-30 | 298 | 41759-04 | 274 | 41862G53 | 359 |
| 41532C15 | 365 | 41589-AB | 388 | 41608-04 | 357 | 41672-00 | 123 | 41727-33 | 298 | 41759-05 | 273 | 41863-35 | 359 |
| 41532C23 | 365 | 41589-AC | 388 | 41608-20 | 357 | 41673-00 | 123 | 41727-36 | 298 | 41759-07 | 274 | 41864-56 | 359 |
| 41532G15 | 365 | 41589-BB | 388 | 41608C04 | 357 | 41674-00 | 123 | 41727-40 | 298 | 41759-08 | 274 | 41865-40 | 359 |
| 41532G23 | 365 | 41589C08 | 388 | 41608G04 | 357 | 41675-00 | 123 | 41727-45 | 298 | 41759-09 | 273 | 41870-01 | 472 |
| 41537-00 | 307 | 41589C16 | 388 | 41609-36 | 337 | 41676-00 | 123 | 41727-50 | 298 | 41760-02 | 274 | 41870-02 | 472 |
| 41537-03 | 307 | 41589-CC | 388 | 41609-75 | 337 | 41677-00 | 123 | 41727-55 | 298 | 41760-05 | 274 | 41870-03 | 472 |
| 41537-06 | 307 | 41590-01 | 497 | 41609A36 | 337 | 41678-00 | 123 | 41727-60 | 298 | 41760-06 | 274 | 41870-04 | 472 |
| 41537-08 | 307 | 41590-02 | 497 | 41609B36 | 337 | 41678-14 | 405 | 41729-30 | 229 | 41760-08 | 274 | 41875-40 | 478 |
| 41538-30 | 309 | 41590-04 | 497 | 41609C36 | 337 | 41679-23 | 398 | 41729-34 | 229 | 41760-09 | 274 | 41875-61 | 478 |
| 41541-44 | 474 | 41590-06 | 497 | 41609G36 | 337 | 41680-03 | 349 | 41734-60 | 298 | 41760-20 | 273 | 41876-30 | 478 |
| 41558-00 | 402 | 41591-10 | 497 | 41611-20 | 343 | 41680-06 | 349 | 41735-20 | 292 | 41760-21 | 273 | 41876-38 | 478 |
| 41559-04 | 401 | 41591-15 | 497 | 41614-22 | 307 | 41680-12 | 349 | 41735-29 | 291 | 41760-22 | 272 | 41876-45 | 478 |
| 41560-28 | 398 | 41591-32 | 401 | 41614-33 | 307 | 41681-01 | 350 | 41736-32 | 291 | 41760-26 | 272 | 41876-58 | 478 |
| 41561-09 | 392 | 41591-36 | 401 | 41614-34 | 307 | 41681-02 | 350 | 41737-17 | 292 | 41760-27 | 272 | 41877-45 | 478 |
| 41562-18 | 401 | 41591-40 | 401 | 41614-35 | 307 | 41681-03 | 350 | 41737-20 | 292 | 41761-02 | 293 | 41877-61 | 478 |
| 41563-07 | 392 | 41591-45 | 401 | 41614-36 | 307 | 41681-04 | 350 | 41737-23 | 292 | 41762-07 | 302 | 41877-81 | 478 |
| 41563-AA | 575 | 41591-90 | 401 | 41615-01 | 392 | 41681-06 | 350 | 41737G20 | 293 | 41762-09 | 302 | 41877-99 | 478 |
| 41564-07 | 392 | 41592-36 | 401 | 41615-03 | 392 | 41681-10 | 349 | 41737G23 | 293 | 41762-13 | 302 | 41878-45 | 478 |
| 41564-AA | 575 | 41592-45 | 401 | 41615-05 | 392 | 41681-11 | 349 | 41738-17 | 292 | 41763-00 | 302 | 41878-61 | 478 |
| 41569-34 | 399 | 41593-20 | 401 | 41617-05 | 308 | 41681-12 | 349 | 41738-20 | 292 | 41763-30 | 525 | 41878-81 | 478 |
| 41570-10 | 135 | 41594-12 | 401 | 41617-15 | 308 | 41681-13 | 349 | 41738-23 | 292 | 41764-33 | 292 | 41878-99 | 478 |
| 41570A10 | 336 | 41594-18 | 400 | 41618-14 | 308 | 41681-99 | 350 | 41739-20 | 292 | 41765-32 | 291 | 41879-30 | 478 |
| 41570B10 | 336 | 41595-20 | 336 | 41628-15 | 405 | 41683-26 | 127 | 41743D32 | 210 | 41765-37 | 291 | 41879-40 | 478 |
| 41570C10 | 336 | 41595B44 | 136 | 41629-17 | 392 | 41686-12 | 401 | 41743D53 | 210 | 41765-41 | 291 | 41879-50 | 478 |
| 41570G10 | 336 | 41595B45 | 136 | 41629-20 | 392 | 41687-06 | 401 | 41743D60 | 210 | 41765-45 | 291 | 41879-61 | 478 |
| 41582-00 | 181 | 41597-04 | 391 | 41629-25 | 392 | 41687-12 | 401 | 41744-32 | 209 | 41765-50 | 291 | 41880-38 | 478 |
| 41583-00 | 182 | 41598-00 | 391 | 41635-02 | 396 | 41690A11 | 505 | 41744-53 | 209 | 41766-14 | 292 | 41880-61 | 478 |
| 41585-00 | 382 | 41599-08 | 391 | 41638-01 | 396 | 41690E11 | 505 | 41744-60 | 209 | 41766-16 | 292 | 41881-30 | 478 |
| 41585-01 | 382 | 41600-00 | 336 | 41638-02 | 396 | 41690U11 | 505 | 41745-30 | 300 | 41766-27 | 292 | 41881-40 | 478 |
| 41585-02 | 382 | 41600C00 | 336 | 41638-04 | 396 | 41691A11 | 505 | 41745-35 | 300 | 41767-20 | 292 | 41882-15 | 478 |
| 41585-03 | 382 | 41600G00 | 336 | 41638-12 | 396 | 41691E11 | 505 | 41745-40 | 300 | 41767-AA | 576 | 41882-20 | 478 |
| 41585-10 | 382 | 41601-17 | 308 | 41638-13 | 396 | 41691U11 | 505 | 41745-50 | 300 | 41767G20 | 293 | 41882-25 | 478 |
| 41585-11 | 381 | 41602-00 | 308 | 41638-91 | 575 | 41695-10 | 510 | 41745-60 | 300 | 41768-21 | 292 | 41882-30 | 478 |
| 41585-12 | 381 | 41603-00 | 337 | 41638-92 | 575 | 41695-15 | 510 | 41745-65 | 300 | 41768-22 | 292 | 41885-40 | 478 |
| 41585-13 | 381 | 41603-07 | 337 | 41638-93 | 575 | 41695-50 | 510 | 41746-60 | 209 | 41769-00 | 293 | 41885-45 | 478 |
| 41585-23 | 381 | 41603A00 | 337 | 41638-94 | 575 | 41697-00 | 125 | 41747-60 | 209 | 41769-01 | 293 | 41885-50 | 478 |
| 41585-24 | 381 | 41603A07 | 337 | 41638-95 | 575 | 41698-22 | 125 | 41748-20 | 210 | 41769-02 | 293 | 41885-60 | 478 |
| 41585-25 | 381 | 41603B00 | 337 | 41639-11 | 397 | 41698-30 | 125 | 41748-30 | 210 | 41769-36 | 292 | 41900-04 | 500 |
| 41585-30 | 381 | 41603B07 | 337 | 41639-17 | 397 | 41698-40 | 125 | 41748-35 | 210 | 41769-50 | 292 | 41900-10 | 500 |
| 41585-37 | 381 | 41603C00 | 337 | 41639-30 | 397 | 41699-03 | 358 | 41748-40 | 210 | 41769G00 | 293 | 41901-08 | 499 |
| 41585-45 | 382 | 41603C07 | 337 | 41639-31 | 397 | 41699-04 | 358 | 41748-50 | 210 | 41770-15 | 299 | 41901-16 | 499 |
| 41585-51 | 382 | 41603G00 | 337 | 41639-40 | 397 | 41699-06 | 357 | 41750-20 | 210 | 41771-96 | 299 | 41903A10 | 506 |
| 41585-52 | 382 | 41603G07 | 337 | 41639-41 | 397 | 41699-10 | 357 | 41750-30 | 210 | 41773-00 | 126 | 41903E10 | 506 |
| 41585-53 | 382 | 41604-00 | 337 | 41639-42 | 397 | 41699-12 | 358 | 41750-40 | 210 | 41774-33 | 295 | 41903U10 | 506 |
| 41585-54 | 382 | 41604-01 | 338 | 41645-00 | 306 | 41699-13 | 358 | 41750-41 | 210 | 41775-34 | 295 | 41904-10 | 500 |
| 41586-22 | 382 | 41604A00 | 337 | 41646-06 | 389 | 41699-18 | 358 | 41750-50 | 210 | 41780-05 | 288 | 41905-38 | 491 |
| 41586-28 | 382 | 41604A01 | 337 | 41646-10 | 389 | 41699-20 | 357 | 41751-30 | 209 | 41780-07 | 288 | 41909-08 | 498 |
| 41586-33 | 382 | 41604B00 | 337 | 41646-15 | 389 | 41699B18 | 358 | 41751-35 | 209 | 41780-09 | 288 | 41910-AL | 576 |
| 41586-38 | 382 | 41604B01 | 338 | 41646-20 | 389 | 41699C18 | 358 | 41751-40 | 209 | 41782-04 | 352 | 41911-02 | 497 |
| 41587-03 | 382 | 41604C00 | 337 | 41650-06 | 388 | 41699G18 | 358 | 41751-50 | 209 | 41782-05 | 352 | 41911-03 | 497 |
| 41587-25 | 382 | 41604C01 | 338 | 41650-10 | 388 | 41703-38 | 59 | 41751-60 | 209 | 41782-06 | 352 | 41911-04 | 497 |
| 41587-32 | 382 | 41604G00 | 337 | 41650-13 | 388 | 41704G33 | 293 | 41751-65 | 209 | 41800-05 | 499 | 41912-03 | 495 |
| 41589-00 | 388 | 41604G01 | 338 | 41651-20 | 476 | 41704G36 | 293 | 41751F30 | 571 | 41800-10 | 499 | 41912-04 | 496 |
| 41589-01 | 388 | 41605-00 | 335 | 41651-25 | 476 | 41707-32 | 59 | 41751F40 | 571 | 41801-05 | 499 | 41913-03 | 496 |
| 41589-02 | 388 | 41605-01 | 335 | 41651-30 | 476 | 41707-36 | 59 | 41751F60 | 571 | 41806-00 | 498 | 41913-04 | 496 |
| 41589-04 | 388 | 41605-03 | 335 | 41651-35 | 476 | 41707-40 | 59 | 41752-08 | 301 | 41806-03 | 498 | 41914-03 | 71 |

NUMERICAL INDEX INDICE NUMERICO NUMERISCH INDEX INDEX NUMERIQUE INDICE NUMERICO

| Cod. | pag. | Cod. | pag. | Cod. | pag. | Cod. | pag. | Cod. | pag. | Cod. | pag. | Cod. | pag. |
|----------|------|----------|------|----------|------|----------|------|----------|------|----------|------|----------|------|
| 41916-10 | 134 | 42452-53 | 482 | 42512-35 | 127 | 42538-05 | 183 | 42574-91 | 577 | 42620P05 | 428 | 42655P15 | 427 |
| 41916-15 | 134 | 42453-23 | 494 | 42512-90 | 534 | 42538-07 | 183 | 42574-92 | 577 | 42620P06 | 428 | 42655S15 | 427 |
| 41916-20 | 134 | 42460-00 | 492 | 42512-91 | 533 | 42538-09 | 183 | 42574-93 | 577 | 42621P03 | 432 | 42660-02 | 436 |
| 41922-16 | 134 | 42460-06 | 493 | 42512-92 | 533 | 42538F09 | 571 | 42574-94 | 577 | 42621P11 | 432 | 42661-03 | 428 |
| 41922-22 | 134 | 42460-27 | 494 | 42512-93 | 533 | 42539-00 | 183 | 42574-99 | 577 | 42622-02 | 437 | 42661-06 | 428 |
| 41925-14 | 135 | 42460-40 | 490 | 42513-30 | 127 | 42539-01 | 183 | 42575-37 | 147 | 42622P15 | 437 | 42662C14 | 431 |
| 41925-16 | 135 | 42460-43 | 498 | 42513-45 | 127 | 42539-02 | 183 | 42575-90 | 577 | 42622S15 | 437 | 42662P14 | 431 |
| 41925-18 | 135 | 42460-45 | 499 | 42514-20 | 179 | 42539-03 | 183 | 42575-91 | 577 | 42623-10 | 123 | 42662S14 | 431 |
| 41925-20 | 135 | 42460-53 | 470 | 42515-18 | 179 | 42539-04 | 183 | 42575-92 | 577 | 42624P10 | 421 | 42663C14 | 431 |
| 41925-22 | 135 | 42460-63 | 493 | 42515-20 | 179 | 42539-05 | 183 | 42575-93 | 577 | 42624S10 | 421 | 42663P14 | 431 |
| 41925-24 | 135 | 42460-64 | 493 | 42516-18 | 179 | 42539-07 | 183 | 42575-94 | 577 | 42625P12 | 427 | 42663S14 | 431 |
| 41925-26 | 135 | 42460-74 | 500 | 42516-20 | 179 | 42539-09 | 183 | 42575-99 | 577 | 42625P18 | 427 | 42664P12 | 414 |
| 41929-00 | 124 | 42460-76 | 500 | 42517-06 | 179 | 42539F09 | 571 | 42576-00 | 146 | 42625S12 | 427 | 42664P18 | 414 |
| 41929-02 | 124 | 42461-11 | 482 | 42518-01 | 183 | 42540-40 | 184 | 42577-39 | 146 | 42625S18 | 427 | 42664P22 | 414 |
| 41930-39 | 70 | 42461-35 | 482 | 42518-50 | 184 | 42540-50 | 184 | 42577-90 | 577 | 42626P12 | 427 | 42664P30 | 414 |
| 41931-08 | 135 | 42461B35 | 482 | 42519-01 | 185 | 42540-80 | 184 | 42577-91 | 577 | 42626P18 | 427 | 42664P40 | 414 |
| 41931-14 | 135 | 42463-02 | 490 | 42520-00 | 185 | 42541-06 | 184 | 42577-92 | 577 | 42626S12 | 427 | 42664S12 | 414 |
| 41931-16 | 135 | 42463A00 | 470 | 42520-AA | 576 | 42542-00 | 185 | 42577-93 | 577 | 42626S18 | 427 | 42664S18 | 414 |
| 41931-18 | 135 | 42463A02 | 489 | 42521-16 | 183 | 42543-00 | 184 | 42577-94 | 577 | 42627P10 | 419 | 42664S22 | 414 |
| 41932-05 | 135 | 42463A04 | 489 | 42521-24 | 183 | 42543-01 | 184 | 42577-99 | 577 | 42627P12 | 419 | 42664S30 | 414 |
| 41933-18 | 135 | 42463A05 | 489 | 42522-00 | 183 | 42543-02 | 184 | 42579-00 | 181 | 42627P18 | 419 | 42665P12 | 414 |
| 41945-38 | 482 | 42463A08 | 489 | 42522-01 | 183 | 42543-03 | 184 | 42581-01 | 128 | 42627P22 | 419 | 42665P18 | 414 |
| 41960-08 | 132 | 42463A12 | 489 | 42522-02 | 183 | 42543-04 | 184 | 42581-03 | 128 | 42627P30 | 419 | 42665P22 | 414 |
| 41960-10 | 132 | 42463A15 | 489 | 42522-03 | 183 | 42543-05 | 184 | 42581-05 | 128 | 42627P40 | 419 | 42665P30 | 414 |
| 41960-12 | 132 | 42463B00 | 470 | 42522-04 | 183 | 42544-00 | 184 | 42581-10 | 128 | 42627S10 | 419 | 42665P40 | 414 |
| 41960-15 | 132 | 42463B02 | 490 | 42522-05 | 183 | 42544-01 | 184 | 42581-15 | 128 | 42627S12 | 419 | 42665S12 | 414 |
| 41961-10 | 132 | 42463B04 | 490 | 42522-07 | 183 | 42544-02 | 184 | 42581-20 | 128 | 42627S18 | 419 | 42665S18 | 414 |
| 41961-12 | 132 | 42463B05 | 490 | 42522-09 | 183 | 42544-03 | 184 | 42584-01 | 397 | 42627S22 | 419 | 42665S22 | 414 |
| 41961-15 | 132 | 42463B08 | 490 | 42522F09 | 571 | 42544-04 | 184 | 42584-02 | 397 | 42627S30 | 419 | 42665S30 | 414 |
| 41962-10 | 133 | 42463B12 | 490 | 42523-00 | 177 | 42544-05 | 184 | 42584-04 | 397 | 42628P10 | 419 | 42665S40 | 414 |
| 41962-12 | 133 | 42463B15 | 490 | 42524-06 | 180 | 42546-00 | 183 | 42584-05 | 397 | 42628P12 | 419 | 42666P12 | 414 |
| 41962-15 | 133 | 42464-02 | 486 | 42524-08 | 180 | 42546-01 | 183 | 42584-06 | 397 | 42628P18 | 419 | 42666P18 | 414 |
| 41964-45 | 70 | 42464-03 | 486 | 42524-10 | 180 | 42546-02 | 183 | 42584-07 | 397 | 42628P22 | 419 | 42666P22 | 414 |
| 41964-60 | 70 | 42470-00 | 492 | 42524-12 | 180 | 42546-03 | 183 | 42584B05 | 397 | 42628P30 | 419 | 42666P27 | 414 |
| 41980-99 | 126 | 42470-06 | 493 | 42524-14 | 180 | 42546-04 | 183 | 42584M01 | 397 | 42628P40 | 419 | 42666P30 | 414 |
| 42400-19 | 500 | 42470-27 | 494 | 42524-16 | 180 | 42546-05 | 183 | 42584M02 | 397 | 42628S10 | 419 | 42666P40 | 414 |
| 42400-25 | 500 | 42470-43 | 498 | 42524-18 | 180 | 42555-11 | 288 | 42584M04 | 397 | 42628S12 | 419 | 42666S12 | 414 |
| 42400-30 | 500 | 42470-45 | 499 | 42524-20 | 180 | 42556-00 | 145 | 42585-00 | 518 | 42628S18 | 419 | 42666S18 | 414 |
| 42401-10 | 389 | 42470-53 | 470 | 42524-22 | 180 | 42558-00 | 146 | 42585-04 | 518 | 42628S22 | 419 | 42666S22 | 414 |
| 42401-15 | 389 | 42470-63 | 493 | 42524-30 | 180 | 42560-01 | 144 | 42585-06 | 518 | 42628S30 | 419 | 42666S27 | 414 |
| 42401-20 | 389 | 42470-64 | 493 | 42525-27 | 180 | 42560-02 | 144 | 42586-09 | 518 | 42629-09 | 434 | 42666S30 | 414 |
| 42401-AA | 576 | 42470-74 | 500 | 42526-12 | 180 | 42560-03 | 144 | 42586-10 | 518 | 42630P01 | 425 | 42666S40 | 414 |
| 42403-01 | 389 | 42470-76 | 500 | 42526-14 | 180 | 42560-04 | 144 | 42588-00 | 138 | 42630P02 | 425 | 42667P12 | 414 |
| 42403B01 | 389 | 42501-15 | 181 | 42528-00 | 184 | 42560-05 | 144 | 42588-01 | 138 | 42630P03 | 425 | 42667P18 | 414 |
| 42405-10 | 389 | 42501-20 | 181 | 42529-06 | 179 | 42560-06 | 144 | 42589-00 | 139 | 42630P04 | 425 | 42667P22 | 414 |
| 42405-20 | 389 | 42502-11 | 181 | 42530-26 | 181 | 42560-07 | 145 | 42592-02 | 125 | 42630P05 | 425 | 42667P30 | 414 |
| 42405-AA | 576 | 42503-10 | 181 | 42530-32 | 181 | 42560-08 | 145 | 42593-00 | 398 | 42630P06 | 425 | 42667S12 | 414 |
| 42406-35 | 500 | 42504-09 | 127 | 42530-41 | 181 | 42560-09 | 145 | 42595-01 | 138 | 42630P07 | 425 | 42667S18 | 414 |
| 42406-40 | 500 | 42505-21 | 180 | 42530-50 | 181 | 42562-12 | 128 | 42596-02 | 138 | 42630P08 | 426 | 42667S22 | 414 |
| 42407-03 | 389 | 42505-24 | 180 | 42531-26 | 181 | 42562-14 | 128 | 42597-00 | 138 | 42630P09 | 426 | 42667S30 | 414 |
| 42407-06 | 389 | 42505-27 | 180 | 42531-32 | 181 | 42562-16 | 128 | 42598-00 | 139 | 42630P10 | 426 | 42669C14 | 431 |
| 42408-03 | 389 | 42505-50 | 180 | 42531-41 | 181 | 42562-18 | 128 | 42599-06 | 140 | 42630P11 | 426 | 42669P14 | 431 |
| 42408-06 | 389 | 42506-08 | 180 | 42531-50 | 181 | 42562-20 | 128 | 42599-08 | 140 | 42630P12 | 426 | 42669S14 | 431 |
| 42408-08 | 389 | 42506-10 | 180 | 42532-29 | 181 | 42562-25 | 128 | 42607-05 | 218 | 42630P13 | 426 | 42670B14 | 430 |
| 42413-24 | 400 | 42506-12 | 180 | 42532-58 | 181 | 42562-30 | 128 | 42609-10 | 130 | 42630S01 | 425 | 42670N14 | 430 |
| 42414-05 | 400 | 42506-14 | 180 | 42533-23 | 218 | 42563-00 | 141 | 42609-15 | 130 | 42630S02 | 425 | 42670W14 | 430 |
| 42414-10 | 400 | 42506-16 | 180 | 42533-26 | 218 | 42563-44 | 141 | 42609-20 | 130 | 42630S03 | 425 | 42674P18 | 421 |
| 42414-15 | 400 | 42506-18 | 180 | 42533-31 | 218 | 42565-00 | 141 | 42609-23 | 130 | 42630S04 | 425 | 42674P22 | 421 |
| 42414-20 | 400 | 42507-12 | 180 | 42533-36 | 218 | 42566-03 | 140 | 42609-25 | 130 | 42630S05 | 425 | 42674P30 | 421 |
| 42417-22 | 400 | 42508-00 | 181 | 42533-40 | 218 | 42569-04 | 145 | 42614-04 | 275 | 42630S06 | 425 | 42674S18 | 421 |
| 42420-06 | 398 | 42508-01 | 181 | 42534-26 | 181 | 42570-32 | 146 | 42614-05 | 275 | 42630S07 | 425 | 42674S22 | 421 |
| 42420-08 | 398 | 42509-25 | 127 | 42534-32 | 181 | 42570-91 | 576 | 42614-06 | 275 | 42630S08 | 426 | 42674S30 | 421 |
| 42445-03 | 406 | 42509-50 | 127 | 42534-41 | 181 | 42570-92 | 576 | 42614-07 | 275 | 42630S09 | 426 | 42676P15 | 427 |
| 42445-04 | 406 | 42509-60 | 127 | 42535-24 | 184 | 42570-94 | 576 | 42614-21 | 218 | 42630S10 | 426 | 42676P20 | 427 |
| 42445-05 | 406 | 42509-99 | 127 | 42535-32 | 184 | 42570-99 | 576 | 42615-04 | 128 | 42630S11 | 426 | 42676S15 | 427 |
| 42446-04 | 406 | 42510-00 | 180 | 42535-49 | 184 | 42571-20 | 146 | 42616-04 | 128 | 42630S12 | 426 | 42676S20 | 427 |
| 42450-00 | 492 | 42511-20 | 180 | 42537-40 | 183 | 42572-24 | 146 | 42617-04 | 391 | 42630S13 | 426 | 42677P14 | 422 |
| 42450-AD | 493 | 42511-25 | 180 | 42537-50 | 183 | 42573-31 | 146 | 42617-05 | 391 | 42631P30 | 433 | 42677S14 | 422 |
| 42451-11 | 493 | 42511-30 | 180 | 42537-80 | 183 | 42573-91 | 576 | 42617-06 | 391 | 42632-01 | 423 | 42678P14 | 430 |
| 42451-12 | 493 | 42511-35 | 180 | 42538-00 | 183 | 42573-92 | 576 | 42617-07 | 391 | 42632-02 | 423 | 42678S14 | 430 |
| 42452-14 | 494 | 42511-40 | 180 | 42538-01 | 183 | 42573-94 | 576 | 42620-02 | 428 | 42632-03 | 423 | 42678W14 | 430 |
| 42452-23 | 494 | 42511-56 | 180 | 42538-02 | 183 | 42573-99 | 576 | 42620P01 | 427 | 42632-04 | 423 | 42679P12 | 430 |
| 42452-35 | 482 | 42511-60 | 180 | 42538-03 | 183 | 42574-37 | 147 | 42620P02 | 427 | 42650-10 | 139 | 42679S12 | 430 |
| 42452-53 | 493 | 42511-70 | 180 | 42538-04 | 183 | 42574-90 | 577 | 42620P03 | 427 | 42650-11 | 139 | 42680-13 | 434 |

| Cod. | pag. | Cod. | pag. | Cod. | pag. | Cod. | pag. | Cod. | pag. | Cod. | pag. | Cod. | pag. | Cod. | pag. |
|----------|------|----------|------|----------|------|----------|------|----------|------|----------|------|----------|------|------|------|
| 42681-16 | 434 | 42721P12 | 414 | 42826-37 | 295 | 42907-10 | 124 | 42967-03 | 479 | 44028-19 | 523 | 44084-01 | 542 | | |
| 42684P08 | 428 | 42721P18 | 414 | 42854-06 | 481 | 42907-30 | 124 | 42967-04 | 479 | 44029-00 | 519 | 44084-02 | 542 | | |
| 42684S08 | 428 | 42721P22 | 414 | 42854-07 | 481 | 42907-35 | 124 | 42967-05 | 479 | 44030-03 | 535 | 44084-03 | 542 | | |
| 42685-22 | 433 | 42721P27 | 414 | 42854B25 | 125 | 42907-40 | 124 | 42967-06 | 479 | 44031-01 | 535 | 44084-04 | 542 | | |
| 42688P18 | 413 | 42721P30 | 414 | 42854B30 | 125 | 42920-02 | 306 | 42967-07 | 479 | 44031-02 | 535 | 44085-01 | 542 | | |
| 42688P22 | 413 | 42721P40 | 414 | 42854C25 | 125 | 42921-00 | 397 | 42967-08 | 479 | 44031-04 | 519 | 44085-02 | 542 | | |
| 42688P30 | 413 | 42721S12 | 414 | 42854C30 | 125 | 42922-08 | 395 | 42967-11 | 482 | 44031-05 | 519 | 44085-03 | 542 | | |
| 42688S18 | 413 | 42721S18 | 414 | 42854G25 | 126 | 42923-07 | 306 | 42967-13 | 479 | 44033A23 | 524 | 44085-04 | 542 | | |
| 42688S22 | 413 | 42721S22 | 414 | 42854G30 | 126 | 42924-02 | 395 | 42967-14 | 479 | 44033B23 | 524 | 44089-12 | 543 | | |
| 42688S30 | 413 | 42721S27 | 414 | 42854K25 | 125 | 42926-12 | 395 | 42967-15 | 479 | 44033B38 | 524 | 44093-00 | 477 | | |
| 42689-15 | 431 | 42721S30 | 414 | 42854K30 | 125 | 42927-02 | 395 | 42967-16 | 479 | 44034-11 | 524 | 44093-01 | 477 | | |
| 42690-15 | 431 | 42723P10 | 433 | 42854R25 | 125 | 42928-00 | 395 | 42967-17 | 479 | 44040-40 | 520 | 44094-00 | 513 | | |
| 42691P12 | 413 | 42723S10 | 433 | 42854R30 | 125 | 42929-01 | 395 | 42967-18 | 479 | 44041-00 | 520 | 44094-03 | 514 | | |
| 42691P18 | 413 | 42725P10 | 433 | 42854Y25 | 125 | 42929-02 | 395 | 42967-35 | 480 | 44041-01 | 520 | 44094-04 | 514 | | |
| 42691P22 | 413 | 42725S10 | 433 | 42854Y30 | 125 | 42929-03 | 396 | 42967-43 | 481 | 44041-03 | 520 | 44094R00 | 513 | | |
| 42691P30 | 413 | 42727-09 | 429 | 42862-00 | 125 | 42931-19 | 394 | 42967-53 | 480 | 44041-04 | 520 | 44094R00 | 514 | | |
| 42691P40 | 413 | 42727-12 | 429 | 42863-00 | 125 | 42935-19 | 393 | 42967-63 | 479 | 44041-05 | 520 | 44094R00 | 514 | | |
| 42691S12 | 413 | 42727-18 | 429 | 42864-10 | 182 | 42935-26 | 393 | 42967-64 | 479 | 44042-00 | 520 | 44094-RE | 578 | | |
| 42691S18 | 413 | 42727-22 | 430 | 42870-50 | 487 | 42936-23 | 484 | 42967-65 | 479 | 44043-00 | 520 | 44095-12 | 543 | | |
| 42691S22 | 413 | 42727-30 | 430 | 42870-59 | 484 | 42936-24 | 484 | 42967-66 | 479 | 44044-00 | 520 | 44095-18 | 543 | | |
| 42691S30 | 413 | 42727-38 | 430 | 42873-01 | 394 | 42936-28 | 484 | 42967-67 | 479 | 44046-20 | 522 | 44095-30 | 535 | | |
| 42694P02 | 417 | 42728-09 | 429 | 42873-02 | 394 | 42939-15 | 406 | 42967-68 | 479 | 44046-40 | 522 | 44095-32 | 535 | | |
| 42694P04 | 417 | 42728-12 | 429 | 42874-01 | 486 | 42939-AA | 577 | 42967-73 | 479 | 44046-60 | 522 | 44096-80 | 543 | | |
| 42694P05 | 416 | 42728-18 | 429 | 42874-02 | 486 | 42940-03 | 472 | 42967-74 | 479 | 44047-17 | 519 | 44096B80 | 543 | | |
| 42694P06 | 417 | 42728-22 | 430 | 42874-03 | 487 | 42942-10 | 405 | 42967-75 | 479 | 44047-19 | 519 | 44096G80 | 543 | | |
| 42694P09 | 416 | 42728-30 | 430 | 42874-04 | 487 | 42942-16 | 405 | 42967-76 | 479 | 44047-22 | 519 | 44096R80 | 543 | | |
| 42694P11 | 416 | 42728-38 | 430 | 42875-17 | 393 | 42944-23 | 393 | 42967-77 | 479 | 44047-25 | 519 | 44096Y80 | 543 | | |
| 42694P12 | 414 | 42728S18 | 429 | 42875-20 | 393 | 42945-18 | 393 | 42967-78 | 479 | 44047-28 | 519 | 44097-00 | 542 | | |
| 42694P13 | 416 | 42741-22 | 422 | 42875B17 | 394 | 42945-23 | 393 | 42967M43 | 481 | 44048-99 | 358 | 44099-03 | 352 | | |
| 42694P18 | 414 | 42742-22 | 422 | 42875B20 | 394 | 42945-27 | 393 | 42967M53 | 480 | 44055-10 | 355 | 44100-01 | 352 | | |
| 42694P22 | 414 | 42746P12 | 412 | 42876-12 | 394 | 42946-23 | 484 | 42968-38 | 484 | 44055-20 | 355 | 44100-02 | 352 | | |
| 42694P30 | 414 | 42746P18 | 412 | 42876-20 | 394 | 42946-37 | 484 | 42968-42 | 480 | 44055-25 | 355 | 44100-04 | 352 | | |
| 42694P40 | 414 | 42746P22 | 412 | 42876-25 | 394 | 42947-23 | 484 | 42968M42 | 480 | 44055-30 | 355 | 44101-03 | 352 | | |
| 42694S02 | 417 | 42746P30 | 412 | 42877-17 | 393 | 42947-30 | 484 | 42969-31 | 480 | 44055-35 | 355 | 44101-AA | 578 | | |
| 42694S07 | 416 | 42746P40 | 412 | 42877-25 | 393 | 42947-40 | 484 | 42969M31 | 480 | 44055-40 | 355 | 44102-24 | 348 | | |
| 42694S09 | 416 | 42746P50 | 412 | 42878-17 | 392 | 42948-18 | 393 | 42972-01 | 480 | 44055-50 | 355 | 44103-03 | 352 | | |
| 42694S10 | 416 | 42746P80 | 412 | 42878-25 | 392 | 42948-20 | 393 | 42972-02 | 480 | 44055C30 | 355 | 44103-04 | 352 | | |
| 42694S12 | 414 | 42746S18 | 412 | 42879K12 | 393 | 42948-23 | 393 | 42972-03 | 480 | 44055C40 | 355 | 44103-06 | 352 | | |
| 42694S13 | 416 | 42746S22 | 412 | 42879K15 | 393 | 42948-25 | 393 | 42972-04 | 480 | 44055G30 | 355 | 44103-AA | 578 | | |
| 42694S18 | 414 | 42746S30 | 412 | 42879K22 | 393 | 42949-26 | 481 | 42972-28 | 480 | 44055G40 | 355 | 44103-AB | 578 | | |
| 42694S22 | 414 | 42747P12 | 412 | 42879K25 | 393 | 42949B26 | 481 | 42973-30 | 480 | 44056-01 | 354 | 44103-AC | 578 | | |
| 42694S30 | 414 | 42747P18 | 412 | 42879M12 | 393 | 42950-01 | 380 | 42973-45 | 480 | 44056-04 | 354 | 44104-01 | 307 | | |
| 42695P22 | 421 | 42747S12 | 412 | 42879M15 | 393 | 42950-02 | 380 | 42973-60 | 480 | 44056-06 | 354 | 44104-02 | 307 | | |
| 42695S22 | 421 | 42747S18 | 412 | 42879M22 | 393 | 42950-03 | 380 | 42974B13 | 393 | 44056-11 | 354 | 44105-00 | 345 | | |
| 42696P22 | 421 | 42749P18 | 412 | 42879M25 | 393 | 42950-04 | 380 | 42974M13 | 393 | 44056-21 | 354 | 44106-12 | 352 | | |
| 42696S22 | 421 | 42749P22 | 412 | 42881-24 | 392 | 42950-05 | 380 | 42979-00 | 473 | 44057-04 | 354 | 44106B05 | 351 | | |
| 42701-10 | 421 | 42749S18 | 412 | 42881-25 | 392 | 42950-06 | 380 | 42979-36 | 473 | 44057-06 | 354 | 44106B10 | 351 | | |
| 42701P10 | 421 | 42749S22 | 412 | 42881-26 | 392 | 42950-08 | 380 | 42979-45 | 473 | 44058-10 | 355 | 44106B20 | 351 | | |
| 42702-10 | 422 | 42763-02 | 437 | 42882-23 | 343 | 42950-09 | 380 | 42981-73 | 473 | 44058-20 | 355 | 44106B25 | 351 | | |
| 42702P10 | 422 | 42763P16 | 437 | 42882-28 | 343 | 42950-92 | 380 | 42982-08 | 473 | 44058-25 | 355 | 44106G05 | 350 | | |
| 42703-10 | 421 | 42763S16 | 437 | 42900-15 | 124 | 42950-93 | 380 | 42988-99 | 466 | 44058-30 | 355 | 44106G10 | 350 | | |
| 42703S10 | 421 | 42764M15 | 432 | 42900-24 | 124 | 42950-94 | 380 | 42988C99 | 466 | 44058-40 | 355 | 44106G20 | 350 | | |
| 42704-10 | 422 | 42764P16 | 429 | 42901-20 | 124 | 42951-08 | 406 | 42988G99 | 466 | 44058-50 | 355 | 44106G25 | 350 | | |
| 42704S10 | 422 | 42764P21 | 429 | 42901-25 | 124 | 42951-57 | 406 | 42990-16 | 481 | 44060-01 | 354 | 44106O05 | 351 | | |
| 42705M15 | 432 | 42764S16 | 429 | 42901-30 | 124 | 42951-59 | 407 | 42990-20 | 481 | 44060-02 | 354 | 44106O10 | 351 | | |
| 42705P10 | 422 | 42764S21 | 429 | 42901-35 | 124 | 42952-05 | 406 | 42990-29 | 481 | 44060-50 | 126 | 44106O20 | 351 | | |
| 42705P16 | 429 | 42767P12 | 427 | 42901-40 | 124 | 42953-04 | 397 | 42990M16 | 481 | 44060-51 | 353 | 44106O25 | 351 | | |
| 42705P21 | 429 | 42767P15 | 427 | 42902-30 | 125 | 42954-04 | 406 | 42990M20 | 481 | 44060-80 | 126 | 44106R05 | 351 | | |
| 42705S10 | 422 | 42767P20 | 427 | 42902-31 | 125 | 42954-18 | 406 | 42990M29 | 481 | 44060-99 | 353 | 44106R10 | 351 | | |
| 42705S16 | 429 | 42767S12 | 427 | 42902B30 | 335 | 42955-00 | 397 | 42991-25 | 481 | 44061-08 | 126 | 44106R20 | 351 | | |
| 42705S21 | 429 | 42767S15 | 427 | 42902C30 | 335 | 42956-19 | 343 | 42991-32 | 481 | 44061-09 | 126 | 44106R25 | 351 | | |
| 42706P10 | 422 | 42767S20 | 427 | 42902G30 | 335 | 42956-24 | 343 | 42991M25 | 481 | 44061-12 | 126 | 44106W05 | 350 | | |
| 42706S10 | 422 | 42785S20 | 436 | 42903-29 | 126 | 42956-28 | 343 | 42991M32 | 481 | 44061-14 | 126 | 44106W10 | 350 | | |
| 42713P10 | 422 | 42786S20 | 436 | 42904-01 | 125 | 42959-12 | 400 | 42993-40 | 481 | 44061B10 | 126 | 44106W20 | 350 | | |
| 42713S10 | 422 | 42796P16 | 429 | 42904-02 | 125 | 42959-13 | 400 | 42993M40 | 481 | 44061B12 | 126 | 44106W25 | 350 | | |
| 42714P10 | 422 | 42796P23 | 429 | 42904-03 | 125 | 42962-26 | 308 | 44009-00 | 519 | 44061G10 | 126 | 44106Y05 | 351 | | |
| 42714S10 | 422 | 42796S16 | 429 | 42907-01 | 124 | 42962-30 | 495 | 44020-21 | 519 | 44061G12 | 126 | 44106Y10 | 351 | | |
| 42717P16 | 429 | 42796S23 | 429 | 42907-02 | 124 | 42962-44 | 495 | 44023-00 | 518 | 44061R10 | 126 | 44106Y20 | 351 | | |
| 42717S16 | 429 | 42798P11 | 429 | 42907-03 | 124 | 42962B30 | 495 | 44023-AA | 577 | 44061R12 | 126 | 44106Y25 | 351 | | |
| 42718P18 | 413 | 42798S11 | 429 | 42907-04 | 124 | 42962B44 | 495 | 44024-00 | 518 | 44061Y10 | 126 | 44107B05 | 352 | | |
| 42718P22 | 413 | 42801P14 | 436 | 42907-06 | 124 | 42962C26 | 309 | 44025-50 | 518 | 44061Y12 | 126 | 44107B10 | 352 | | |
| 42718S18 | 413 | 42801S14 | 436 | 42907-07 | 124 | 42962C44 | 495 | 44026-60 | 536 | 44077-00 | 541 | 44107B20 | 352 | | |
| 42718S22 | 413 | 42822-00 | 293 | 42907-08 | 124 | 42964-53 | 185 | 44027-00 | 519 | 44077-10 | 541 | 44107B25 | 352 | | |
| 42720-01 | 432 | 42826-32 | 295 | 42907-09 | 124 | 42964-60 | 185 | 44027-AA | 577 | 44077-CC | 541 | 44107G05 | 351 | | |

NUMERICAL INDEX INDICE NUMERICO NUMERISCH INDEX INDEX NUMERIQUE INDICE NUMERICO

| Cod. | pag. | Cod. | pag. | Cod. | pag. | Cod. | pag. | Cod. | pag. | Cod. | pag. | Cod. | pag. |
|----------|------|----------|------|----------|------|----------|------|----------|------|----------|------|----------|------|
| 44107G10 | 351 | 44169B06 | 541 | 44214-25 | 64 | 44314G06 | 100 | 44374-36 | 73 | 44455B09 | 278 | 44478-30 | 385 |
| 44107G20 | 351 | 44169B14 | 541 | 44215S16 | 66 | 44314O06 | 100 | 44374-40 | 73 | 44456-14 | 278 | 44478-31 | 385 |
| 44107G25 | 351 | 44169R06 | 541 | 44216S16 | 66 | 44314R06 | 100 | 44374-44 | 73 | 44456B14 | 278 | 44478-32 | 385 |
| 44107O05 | 351 | 44169R25 | 541 | 44217-45 | 65 | 44314Y06 | 100 | 44375-25 | 73 | 44457-32 | 278 | 44478-33 | 385 |
| 44107O10 | 351 | 44170-00 | 539 | 44218R30 | 64 | 44315A06 | 100 | 44376-40 | 73 | 44457B32 | 278 | 44478-34 | 385 |
| 44107O20 | 351 | 44170-01 | 540 | 44218R40 | 64 | 44315B06 | 100 | 44378-06 | 73 | 44459-28 | 279 | 44478-35 | 385 |
| 44107O25 | 351 | 44171-24 | 541 | 44219R24 | 63 | 44315G06 | 100 | 44379-03 | 392 | 44459B28 | 279 | 44480-00 | 384 |
| 44107R05 | 351 | 44171-50 | 541 | 44219R26 | 63 | 44315O06 | 100 | 44379-05 | 392 | 44461-20 | 278 | 44480-01 | 384 |
| 44107R10 | 351 | 44172-30 | 541 | 44219R31 | 63 | 44315R06 | 100 | 44382A06 | 98 | 44461B20 | 278 | 44480-03 | 383 |
| 44107R20 | 351 | 44173-00 | 541 | 44220-AA | 68 | 44315Y06 | 100 | 44382B06 | 98 | 44462-25 | 278 | 44480-04 | 384 |
| 44107R25 | 351 | 44174-24 | 538 | 44220S15 | 67 | 44317A06 | 100 | 44382G06 | 98 | 44462B25 | 278 | 44480-05 | 384 |
| 44107W05 | 351 | 44174-AA | 578 | 44220S24 | 66 | 44317B06 | 100 | 44382O06 | 98 | 44463-11 | 277 | 44480-06 | 383 |
| 44107W10 | 351 | 44175-15 | 539 | 44221S30 | 66 | 44317G06 | 100 | 44382Y06 | 98 | 44464-23 | 277 | 44480-07 | 383 |
| 44107W20 | 351 | 44176-30 | 539 | 44222S20 | 66 | 44317O06 | 100 | 44383O06 | 98 | 44465-24 | 277 | 44480-08 | 383 |
| 44107W25 | 351 | 44177-12 | 538 | 44222S28 | 66 | 44317R06 | 100 | 44383Y06 | 98 | 44466-07 | 465 | 44480-09 | 384 |
| 44107Y05 | 351 | 44178-01 | 538 | 44224-22 | 65 | 44317Y06 | 100 | 44384A06 | 98 | 44466-11 | 371 | 44480-10 | 383 |
| 44107Y10 | 351 | 44178-02 | 538 | 44224S22 | 65 | 44322-02 | 83 | 44384O06 | 98 | 44466-12 | 371 | 44480-11 | 383 |
| 44107Y20 | 351 | 44183-01 | 545 | 44225-22 | 65 | 44322-04 | 83 | 44384R06 | 98 | 44466-13 | 371 | 44480-12 | 383 |
| 44107Y25 | 351 | 44183-A3 | 545 | 44226S30 | 65 | 44322-06 | 83 | 44384Y06 | 98 | 44466-14 | 371 | 44480-15 | 383 |
| 44108-01 | 350 | 44183-A4 | 545 | 44227-30 | 65 | 44332-03 | 97 | 44385A06 | 98 | 44466-15 | 371 | 44480-16 | 383 |
| 44110-00 | 356 | 44184-01 | 545 | 44228S23 | 66 | 44332-06 | 97 | 44385B06 | 98 | 44466-16 | 465 | 44480-17 | 384 |
| 44110-01 | 356 | 44184-A3 | 545 | 44230S14 | 66 | 44332B06 | 98 | 44385G06 | 98 | 44470-03 | 467 | 44480-18 | 384 |
| 44110-02 | 356 | 44184-A4 | 545 | 44232S16 | 66 | 44333-03 | 97 | 44385O06 | 98 | 44470-04 | 467 | 44480-19 | 384 |
| 44110-03 | 356 | 44185-50 | 488 | 44232S20 | 66 | 44333-06 | 97 | 44385R06 | 98 | 44470-11 | 467 | 44480-20 | 383 |
| 44110-04 | 356 | 44185-70 | 488 | 44233-20 | 66 | 44333B06 | 98 | 44385Y06 | 98 | 44470-12 | 467 | 44501-01 | 71 |
| 44110-05 | 356 | 44187-40 | 488 | 44234-12 | 36 | 44334-03 | 97 | 44387A06 | 98 | 44470-13 | 467 | 44501-02 | 71 |
| 44110-06 | 356 | 44187-60 | 488 | 44234-16 | 36 | 44334-06 | 97 | 44387B06 | 98 | 44470-14 | 467 | 44501-03 | 71 |
| 44111-02 | 355 | 44201-01 | 36 | 44234S16 | 67 | 44335-03 | 97 | 44387G06 | 98 | 44470-22 | 467 | 44501-04 | 71 |
| 44112-01 | 356 | 44201-03 | 36 | 44237S15 | 67 | 44335-06 | 97 | 44387O06 | 98 | 44470-24 | 467 | 44502-01 | 71 |
| 44112-02 | 356 | 44201-10 | 36 | 44240-08 | 68 | 44335B06 | 98 | 44387R06 | 98 | 44470-30 | 467 | 44502-02 | 71 |
| 44114-01 | 356 | 44201B10 | 35 | 44240S08 | 68 | 44337-03 | 97 | 44387Y06 | 98 | 44470-31 | 467 | 44502-03 | 71 |
| 44114-02 | 356 | 44201B12 | 35 | 44241-19 | 68 | 44337-06 | 97 | 44390-07 | 73 | 44470-38 | 467 | 44502-04 | 71 |
| 44114-03 | 356 | 44201N10 | 35 | 44242-00 | 68 | 44337B06 | 98 | 44390-09 | 73 | 44470-40 | 467 | 44503-01 | 71 |
| 44114C03 | 356 | 44201N12 | 35 | 44243-00 | 68 | 44338-03 | 97 | 44390-11 | 73 | 44470-73 | 467 | 44503-02 | 71 |
| 44114G03 | 356 | 44201N16 | 62 | 44244S36 | 67 | 44338-06 | 97 | 44390-15 | 73 | 44470-74 | 467 | 44503-03 | 71 |
| 44118-10 | 356 | 44201N20 | 62 | 44245S32 | 67 | 44339-03 | 97 | 44390-18 | 73 | 44470-75 | 467 | 44503-04 | 71 |
| 44118-20 | 356 | 44201N24 | 62 | 44246S14 | 67 | 44339-06 | 97 | 44390-23 | 73 | 44473-02 | 295 | 44511-27 | 525 |
| 44118-25 | 356 | 44201N28 | 62 | 44246S17 | 67 | 44342-06 | 100 | 44391-12 | 73 | 44473-03 | 295 | 44511-34 | 525 |
| 44118-30 | 356 | 44201N32 | 62 | 44247S16 | 36 | 44343-06 | 100 | 44394-18 | 73 | 44473-05 | 368 | 44511-38 | 525 |
| 44118-35 | 356 | 44201O10 | 35 | 44248S60 | 370 | 44344-06 | 100 | 44394-21 | 73 | 44473-07 | 368 | 44511-42 | 525 |
| 44118-40 | 356 | 44201O12 | 35 | 44250S30 | 370 | 44345-06 | 100 | 44395-18 | 73 | 44473-08 | 368 | 44511-63 | 525 |
| 44118-50 | 356 | 44201R10 | 35 | 44252-32 | 64 | 44346-06 | 100 | 44397-18 | 73 | 44473-31 | 367 | 44511-90 | 525 |
| 44119-01 | 356 | 44201R12 | 35 | 44253-30 | 63 | 44347-06 | 100 | 44412-00 | 83 | 44473-32 | 367 | 44511E21 | 524 |
| 44119-02 | 356 | 44201R16 | 62 | 44254-30 | 370 | 44352-30 | 509 | 44421-00 | 83 | 44473-33 | 367 | 44511E63 | 524 |
| 44119-03 | 356 | 44201R20 | 62 | 44256-02 | 371 | 44352-40 | 509 | 44422-00 | 83 | 44473-34 | 367 | 44511E90 | 524 |
| 44119-04 | 356 | 44201R24 | 62 | 44256-03 | 371 | 44355-30 | 509 | 44423-00 | 83 | 44474-09 | 311 | 44512-34 | 525 |
| 44119-06 | 356 | 44201R28 | 62 | 44256-04 | 371 | 44355-40 | 509 | 44430-60 | 208 | 44474-13 | 311 | 44512-42 | 525 |
| 44130-01 | 354 | 44201R32 | 62 | 44258-60 | 371 | 44357B07 | 281 | 44430-61 | 209 | 44474-24 | 311 | 44512-63 | 525 |
| 44130-02 | 354 | 44201V10 | 35 | 44264-35 | 371 | 44364-04 | 133 | 44431-46 | 209 | 44474-25 | 311 | 44512-90 | 525 |
| 44130-03 | 354 | 44201V12 | 35 | 44265-35 | 371 | 44364-10 | 133 | 44431-60 | 209 | 44474-33 | 311 | 44512E12 | 524 |
| 44135-02 | 354 | 44202-10 | 36 | 44270-16 | 36 | 44364-25 | 133 | 44432-21 | 83 | 44474-34 | 311 | 44512E21 | 524 |
| 44141-01 | 540 | 44202N12 | 35 | 44271-33 | 67 | 44364-40 | 133 | 44450-11 | 279 | 44474-38 | 311 | 44513-34 | 525 |
| 44141-03 | 540 | 44202N25 | 62 | 44272-11 | 68 | 44364-80 | 133 | 44450-12 | 278 | 44474-39 | 311 | 44513-38 | 525 |
| 44142-40 | 540 | 44202N29 | 62 | 44272-14 | 68 | 44364-99 | 133 | 44450-13 | 279 | 44476-30 | 472 | 44513-54 | 525 |
| 44147-30 | 540 | 44202R12 | 35 | 44272-17 | 68 | 44365-04 | 133 | 44450-15 | 279 | 44476-31 | 472 | 44513-63 | 525 |
| 44147-31 | 540 | 44202R29 | 62 | 44273-24 | 68 | 44365-10 | 133 | 44450-17 | 278 | 44476-51 | 472 | 44513-90 | 525 |
| 44147-32 | 540 | 44204R24 | 62 | 44273-32 | 68 | 44365-25 | 133 | 44450-21 | 278 | 44476-52 | 471 | 44513E12 | 524 |
| 44147-33 | 540 | 44204R28 | 62 | 44274-24 | 68 | 44365-40 | 133 | 44450-23 | 279 | 44476-53 | 471 | 44513E21 | 524 |
| 44149-03 | 539 | 44204R32 | 62 | 44275A26 | 61 | 44365-80 | 133 | 44450B11 | 279 | 44477-76 | 471 | 44521-16 | 525 |
| 44150-19 | 539 | 44207-20 | 62 | 44275B26 | 61 | 44365-99 | 133 | 44450B12 | 278 | 44477-77 | 471 | 44521-21 | 525 |
| 44151-00 | 539 | 44208G00 | 68 | 44275G26 | 61 | 44371-24 | 73 | 44450B13 | 279 | 44477-78 | 471 | 44521-31 | 525 |
| 44151-AA | 539 | 44208R00 | 68 | 44312A06 | 100 | 44371-28 | 73 | 44450B15 | 279 | 44477-79 | 471 | 44521E10 | 525 |
| 44151-AB | 539 | 44209R26 | 63 | 44312B06 | 100 | 44371-32 | 73 | 44450B17 | 278 | 44477-80 | 471 | 44522-16 | 525 |
| 44151-AC | 539 | 44209R32 | 63 | 44312G06 | 100 | 44371-36 | 73 | 44450B21 | 278 | 44477-81 | 471 | 44522-21 | 525 |
| 44160-03 | 539 | 44210-26 | 64 | 44312O06 | 100 | 44371-40 | 73 | 44450B23 | 279 | 44478-20 | 384 | 44522-31 | 525 |
| 44160-AA | 578 | 44210-32 | 64 | 44312R06 | 100 | 44371-44 | 73 | 44451-22 | 278 | 44478-21 | 384 | 44522E10 | 525 |
| 44161-00 | 540 | 44210-42 | 64 | 44312Y06 | 100 | 44371-48 | 73 | 44451B22 | 278 | 44478-22 | 384 | 44628-02 | 521 |
| 44164-00 | 540 | 44210S32 | 64 | 44313B06 | 100 | 44372-26 | 73 | 44452-31 | 278 | 44478-23 | 385 | 44628-04 | 521 |
| 44165-35 | 540 | 44211R01 | 63 | 44313G06 | 100 | 44372-32 | 73 | 44452B31 | 278 | 44478-24 | 385 | 44628-06 | 521 |
| 44165-40 | 540 | 44211R02 | 64 | 44313O06 | 100 | 44372-36 | 73 | 44453-14 | 278 | 44478-25 | 385 | 44628-08 | 521 |
| 44165-50 | 540 | 44211R03 | 63 | 44313R06 | 100 | 44372-40 | 73 | 44453B14 | 278 | 44478-26 | 385 | 44628-11 | 521 |
| 44166-28 | 540 | 44212-30 | 64 | 44313Y06 | 100 | 44374-22 | 73 | 44454-11 | 278 | 44478-27 | 385 | 44628-17 | 521 |
| 44167-13 | 540 | 44213-24 | 64 | 44314A06 | 100 | 44374-25 | 73 | 44454B11 | 278 | 44478-28 | 385 | 44628-20 | 521 |
| 44168-12 | 541 | 44213-36 | 64 | 44314B06 | 100 | 44374-32 | 73 | 44455-09 | 278 | 44478-29 | 385 | 44628-21 | 521 |

| Cod. | pag. | Cod. | pag. | Cod. | pag. | Cod. | pag. | Cod. | pag. | Cod. | pag. | Cod. | pag. |
|----------|------|----------|------|----------|------|----------|------|----------|------|----------|------|----------|------|
| 44628-22 | 521 | 44702T36 | 442 | 44833-99 | 532 | 44860-25 | 468 | 44940-12 | 341 | 44970-20 | 528 | 47018-50 | 231 |
| 44628-23 | 521 | 44702Y21 | 452 | 44837-05 | 494 | 44860-27 | 468 | 44940-13 | 341 | 44970-34 | 528 | 47020-15 | 206 |
| 44629-03 | 522 | 44702Y28 | 452 | 44837-20 | 494 | 44871-20 | 342 | 44940-14 | 341 | 44972-20 | 527 | 47020-20 | 206 |
| 44629-04 | 522 | 44702Y36 | 452 | 44837-25 | 494 | 44871-21 | 342 | 44940-16 | 341 | 44972-25 | 527 | 47020-30 | 206 |
| 44629-05 | 522 | 44703B27 | 446 | 44837B05 | 494 | 44871-22 | 342 | 44940-17 | 341 | 44972-33 | 527 | 47020-35 | 206 |
| 44629-06 | 522 | 44703B34 | 446 | 44837B20 | 494 | 44871-23 | 342 | 44940-18 | 341 | 44974-21 | 528 | 47021-35 | 206 |
| 44629-07 | 522 | 44703C27 | 444 | 44837B25 | 494 | 44871-28 | 342 | 44940-19 | 341 | 44974-27 | 528 | 47021-45 | 206 |
| 44629-B7 | 522 | 44703C34 | 444 | 44840-08 | 470 | 44871-29 | 342 | 44940-24 | 341 | 44974-31 | 528 | 47022-12 | 218 |
| 44629-R4 | 522 | 44703R27 | 440 | 44840-10 | 470 | 44871-30 | 342 | 44940-25 | 341 | 44975-50 | 227 | 47023-01 | 306 |
| 44630-01 | 154 | 44703R34 | 440 | 44840-18 | 470 | 44871-31 | 342 | 44940-26 | 341 | 44975C50 | 518 | 47023-02 | 306 |
| 44630-02 | 154 | 44703S27 | 448 | 44840-30 | 470 | 44871-32 | 342 | 44940-32 | 341 | 44975H50 | 227 | 47023-03 | 306 |
| 44630-03 | 154 | 44703S34 | 448 | 44840-31 | 470 | 44871-33 | 342 | 44940-33 | 341 | 44976-01 | 529 | 47023-04 | 306 |
| 44630-04 | 154 | 44704B22 | 446 | 44840-32 | 470 | 44871-34 | 342 | 44940-34 | 341 | 44976-02 | 529 | 47024-06 | 215 |
| 44630-05 | 155 | 44704C22 | 444 | 44840-40 | 470 | 44871-35 | 342 | 44941A05 | 327 | 44976-03 | 529 | 47024-10 | 215 |
| 44630-06 | 155 | 44704R22 | 440 | 44840-41 | 470 | 44871B20 | 342 | 44941B05 | 331 | 44976-04 | 529 | 47025-06 | 215 |
| 44630-07 | 155 | 44704S22 | 448 | 44840-42 | 470 | 44871B21 | 342 | 44941C05 | 331 | 44977-12 | 529 | 47025-10 | 215 |
| 44701B25 | 446 | 44705C37 | 445 | 44840-50 | 471 | 44871G20 | 342 | 44941G05 | 331 | 44978-20 | 528 | 47026-06 | 215 |
| 44701B32 | 446 | 44706C31 | 444 | 44840-51 | 471 | 44871G21 | 342 | 44942-01 | 343 | 44979-02 | 529 | 47027-11 | 215 |
| 44701B36 | 446 | 44706C40 | 444 | 44840-52 | 471 | 44871L20 | 342 | 44942-02 | 343 | 44979-04 | 529 | 47027-12 | 215 |
| 44701B40 | 446 | 44706R31 | 440 | 44840-54 | 471 | 44871L21 | 342 | 44942-03 | 343 | 44979-05 | 529 | 47027-14 | 215 |
| 44701C22 | 444 | 44706R40 | 440 | 44840-55 | 471 | 44871R20 | 342 | 44942-04 | 343 | 44979-06 | 529 | 47027-15 | 215 |
| 44701C25 | 444 | 44706S31 | 448 | 44840-56 | 471 | 44871R21 | 342 | 44942-05 | 343 | 44982-04 | 275 | 47027-16 | 215 |
| 44701C32 | 444 | 44706S40 | 448 | 44840-57 | 471 | 44873-08 | 310 | 44942-06 | 319 | 44982-06 | 275 | 47028-12 | 215 |
| 44701C36 | 444 | 44707C40 | 444 | 44840-58 | 471 | 44873-16 | 310 | 44942-07 | 319 | 44982-10 | 275 | 47029-12 | 215 |
| 44701C40 | 444 | 44707R40 | 440 | 44841-18 | 464 | 44874-08 | 309 | 44942-10 | 319 | 44983-01 | 526 | 47030-30 | 216 |
| 44701K22 | 453 | 44707S40 | 448 | 44841-21 | 464 | 44874-16 | 309 | 44942-11 | 319 | 44983-02 | 527 | 47031-44 | 213 |
| 44701K25 | 453 | 44708B28 | 446 | 44841-26 | 464 | 44877-11 | 95 | 44944A07 | 327 | 44983-03 | 527 | 47031-46 | 213 |
| 44701K32 | 453 | 44708B30 | 446 | 44841-37 | 464 | 44877-12 | 95 | 44944C07 | 327 | 44986-17 | 527 | 47032-10 | 216 |
| 44701K36 | 453 | 44708C28 | 445 | 44841-51 | 464 | 44877-13 | 96 | 44944G07 | 327 | 44986-21 | 527 | 47032-20 | 216 |
| 44701K40 | 453 | 44708C30 | 445 | 44841B51 | 464 | 44877-14 | 96 | 44945C05 | 328 | 44986-28 | 527 | 47033-08 | 216 |
| 44701M25 | 443 | 44708R28 | 441 | 44842-30 | 464 | 44877-16 | 96 | 44945G05 | 328 | 44987-11 | 528 | 47033-12 | 216 |
| 44701M32 | 443 | 44708R30 | 441 | 44842-31 | 464 | 44877-24 | 95 | 44946-04 | 474 | 44987-60 | 528 | 47033-14 | 216 |
| 44701M40 | 443 | 44708S28 | 449 | 44842-35 | 464 | 44877B11 | 95 | 44946-20 | 402 | 44987C11 | 529 | 47033-50 | 213 |
| 44701R22 | 440 | 44708S30 | 449 | 44842-53 | 464 | 44877B12 | 95 | 44946-29 | 402 | 44987C60 | 529 | 47034-23 | 216 |
| 44701R25 | 440 | 44709B31 | 446 | 44842B31 | 464 | 44877B13 | 96 | 44946-40 | 402 | 44987C62 | 529 | 47034-50 | 216 |
| 44701R32 | 440 | 44709C31 | 445 | 44842B53 | 464 | 44877B14 | 96 | 44946B05 | 474 | 44990-15 | 342 | 47034-51 | 216 |
| 44701R36 | 440 | 44709R31 | 441 | 44843-11 | 464 | 44877B16 | 96 | 44947-00 | 183 | 44990-24 | 342 | 47034-52 | 216 |
| 44701R40 | 440 | 44709S31 | 449 | 44843-12 | 464 | 44877B24 | 95 | 44948-07 | 332 | 44990-29 | 342 | 47035-40 | 216 |
| 44701S22 | 448 | 44710R20 | 441 | 44843-13 | 464 | 44878-11 | 95 | 44949-01 | 332 | 44990-36 | 342 | 47035-48 | 216 |
| 44701S25 | 448 | 44710S20 | 449 | 44843-14 | 464 | 44878-12 | 95 | 44949-02 | 332 | 44990-48 | 342 | 47036-30 | 216 |
| 44701S32 | 448 | 44711-01 | 454 | 44843-24 | 464 | 44878-13 | 96 | 44949-03 | 332 | 44991-22 | 127 | 47036-35 | 216 |
| 44701S36 | 448 | 44711-02 | 454 | 44843B11 | 464 | 44878-14 | 96 | 44949-04 | 332 | 44991-24 | 127 | 47036-40 | 216 |
| 44701S40 | 448 | 44713C02 | 456 | 44843B12 | 464 | 44878-16 | 96 | 44949-05 | 332 | 44991-28 | 127 | 47036-45 | 216 |
| 44701T25 | 442 | 44713K02 | 456 | 44843B13 | 464 | 44878-24 | 95 | 44949-06 | 332 | 44991-29 | 127 | 47036-50 | 216 |
| 44701T32 | 442 | 44713R02 | 456 | 44843B14 | 464 | 44878B11 | 95 | 44949-07 | 332 | 44992-02 | 390 | 47036-60 | 216 |
| 44701T40 | 442 | 44713S02 | 456 | 44843B24 | 464 | 44878B12 | 95 | 44949-08 | 332 | 44992-03 | 389 | 47037-30 | 216 |
| 44701Y25 | 452 | 44801-09 | 534 | 44844-01 | 463 | 44878B13 | 96 | 44949-09 | 332 | 44992-10 | 391 | 47037-40 | 216 |
| 44701Y32 | 452 | 44801-18 | 535 | 44844B01 | 463 | 44878B14 | 96 | 44949-10 | 333 | 44992-15 | 390 | 47038-50 | 216 |
| 44701Y36 | 452 | 44803-10 | 533 | 44845-30 | 465 | 44878B16 | 96 | 44950-15 | 392 | 44993-01 | 391 | 47038-60 | 216 |
| 44701Y40 | 452 | 44803-20 | 533 | 44845-31 | 310 | 44878B24 | 95 | 44950-20 | 392 | 44994-00 | 390 | 47041-01 | 274 |
| 44702B21 | 446 | 44803-30 | 533 | 44845-38 | 465 | 44884-12 | 495 | 44950-25 | 392 | 44995-10 | 391 | 47041-02 | 274 |
| 44702B28 | 446 | 44807-18 | 534 | 44845-41 | 465 | 44884-19 | 495 | 44950-30 | 392 | 44995-14 | 390 | 47041-05 | 274 |
| 44702B36 | 446 | 44807-28 | 534 | 44845-51 | 465 | 44884-25 | 495 | 44950-38 | 392 | 44995-15 | 390 | 47041-07 | 275 |
| 44702C18 | 444 | 44807-36 | 534 | 44846-05 | 463 | 44884B12 | 495 | 44960-01 | 297 | 44997-22 | 127 | 47042-19 | 275 |
| 44702C21 | 444 | 44818-11 | 96 | 44846-09 | 463 | 44884B19 | 495 | 44960-02 | 297 | 44997-24 | 127 | 47042-22 | 275 |
| 44702C28 | 444 | 44818-12 | 96 | 44846-13 | 463 | 44884B25 | 495 | 44960-03 | 297 | 44997-26 | 127 | 47042-25 | 275 |
| 44702C36 | 444 | 44818-13 | 96 | 44846B05 | 371 | 44885-19 | 495 | 44960-04 | 297 | 44997-28 | 127 | 47043-27 | 275 |
| 44702K18 | 453 | 44818-14 | 96 | 44846B09 | 463 | 44885-25 | 495 | 44960-06 | 297 | 44998-31 | 127 | 47043-35 | 275 |
| 44702K21 | 453 | 44818-16 | 96 | 44846B13 | 463 | 44930-10 | 531 | 44960-07 | 297 | 44999-09 | 389 | 47043-42 | 275 |
| 44702K28 | 453 | 44819-02 | 534 | 44847-09 | 463 | 44930-20 | 531 | 44960-10 | 297 | 44999-16 | 389 | 47060-06 | 226 |
| 44702K36 | 453 | 44819-03 | 534 | 44847-13 | 463 | 44932-15 | 531 | 44960-11 | 297 | 46116-15 | 347 | 47060-07 | 226 |
| 44702M21 | 443 | 44820-80 | 534 | 44847-20 | 463 | 44932-20 | 531 | 44960-13 | 297 | 46118-20 | 402 | 47060-09 | 226 |
| 44702M28 | 443 | 44820-99 | 534 | 44847B09 | 463 | 44934-30 | 531 | 44960K10 | 298 | 46120-18 | 402 | 47060-10 | 226 |
| 44702M36 | 443 | 44822-80 | 535 | 44847B13 | 463 | 44936-01 | 531 | 44960K11 | 298 | 46120-22 | 402 | 47060-12 | 226 |
| 44702R18 | 440 | 44822-99 | 535 | 44847B20 | 463 | 44936-22 | 531 | 44961-02 | 528 | 46120-24 | 402 | 47060-14 | 226 |
| 44702R21 | 440 | 44825-20 | 536 | 44850-11 | 465 | 44936-25 | 531 | 44961-03 | 296 | 46123-00 | 405 | 47060-16 | 226 |
| 44702R28 | 440 | 44825-40 | 536 | 44850-12 | 466 | 44937-01 | 530 | 44961-04 | 528 | 46796-00 | 357 | 47060-18 | 226 |
| 44702R36 | 440 | 44826-00 | 534 | 44850-13 | 281 | 44937-02 | 530 | 44961-06 | 528 | 47005-24 | 229 | 47060-20 | 226 |
| 44702S18 | 448 | 44826-20 | 536 | 44850B11 | 465 | 44940-01 | 340 | 44961M03 | 296 | 47006-25 | 229 | 47060-22 | 226 |
| 44702S21 | 448 | 44830-52 | 532 | 44850B12 | 466 | 44940-02 | 340 | 44962-01 | 297 | 47007-26 | 233 | 47060-24 | 226 |
| 44702S28 | 448 | 44830-72 | 532 | 44850B13 | 281 | 44940-06 | 340 | 44962-05 | 298 | 47010-20 | 207 | 47060-26 | 226 |
| 44702S36 | 448 | 44830-99 | 532 | 44850G12 | 466 | 44940-08 | 341 | 44968-00 | 529 | 47011-01 | 220 | 47060-30 | 226 |
| 44702T21 | 442 | 44831-52 | 532 | 44851-01 | 466 | 44940-10 | 341 | 44970-10 | 527 | 47014-35 | 231 | 47062-18 | 226 |
| 44702T28 | 442 | 44832-99 | 532 | 44860-21 | 468 | 44940-11 | 341 | 44970-15 | 527 | 47018-30 | 231 | 47062-20 | 226 |

NUMERICAL INDEX INDICE NUMERICO NUMERISCH INDEX INDEX NUMERIQUE INDICE NUMERICO

| Cod. | pag. | Cod. | pag. | Cod. | pag. | Cod. | pag. | Cod. | pag. | Cod. | pag. | Cod. | pag. |
|----------|------|----------|------|----------|------|----------|------|----------|------|----------|------|----------|------|
| 47062-22 | 226 | 47106-55 | 206 | 47302-10 | 189 | 47357-07 | 200 | 47404-04 | 194 | 47529-07 | 221 | 47546-18 | 223 |
| 47063-01 | 226 | 47106-60 | 206 | 47303-10 | 189 | 47357-08 | 201 | 47404-08 | 195 | 47530-14 | 221 | 47546-30 | 223 |
| 47063-02 | 226 | 47106-65 | 206 | 47304-06 | 189 | 47357-09 | 201 | 47411-01 | 191 | 47530-16 | 221 | 47546-40 | 223 |
| 47063-05 | 226 | 47106-70 | 206 | 47304-10 | 189 | 47357-10 | 201 | 47411-02 | 191 | 47530-18 | 221 | 47546-41 | 224 |
| 47063-07 | 226 | 47106-75 | 206 | 47304-12 | 189 | 47357-11 | 201 | 47411-03 | 192 | 47530-20 | 221 | 47546-42 | 224 |
| 47063-10 | 226 | 47107-00 | 208 | 47305-12 | 189 | 47357-20 | 199 | 47411-08 | 191 | 47530-22 | 221 | 47546-43 | 224 |
| 47064-18 | 226 | 47108-00 | 208 | 47306-10 | 189 | 47357-21 | 199 | 47412-08 | 191 | 47530-24 | 221 | 47546-51 | 224 |
| 47064-22 | 226 | 47110-23 | 208 | 47307-10 | 189 | 47357-22 | 199 | 47413-01 | 191 | 47530-26 | 221 | 47546-52 | 224 |
| 47064-26 | 226 | 47111-30 | 207 | 47308-10 | 189 | 47357-24 | 199 | 47413-08 | 191 | 47530-28 | 221 | 47546-53 | 224 |
| 47064-30 | 226 | 47111-40 | 207 | 47310-10 | 189 | 47357-28 | 200 | 47414-03 | 190 | 47530-30 | 221 | 47547-22 | 223 |
| 47066-03 | 226 | 47111-46 | 207 | 47312-10 | 189 | 47357-29 | 200 | 47415-03 | 190 | 47532-06 | 221 | 47547-26 | 223 |
| 47066-04 | 226 | 47111-55 | 207 | 47314-10 | 189 | 47357-30 | 200 | 47416-06 | 190 | 47532-07 | 221 | 47547-30 | 223 |
| 47066-05 | 226 | 47112-34 | 207 | 47315-10 | 189 | 47357-31 | 200 | 47417-06 | 190 | 47532-08 | 221 | 47548-02 | 223 |
| 47066-06 | 226 | 47112-45 | 207 | 47316-10 | 189 | 47357-38 | 205 | 47419-10 | 190 | 47532-12 | 221 | 47548-03 | 223 |
| 47066-07 | 226 | 47112-50 | 207 | 47316-12 | 189 | 47357-40 | 204 | 47421-09 | 196 | 47532-14 | 221 | 47548-04 | 223 |
| 47066-08 | 226 | 47113-03 | 208 | 47316-20 | 189 | 47357-41 | 204 | 47422-26 | 196 | 47532-16 | 221 | 47548-05 | 223 |
| 47068-12 | 226 | 47118-30 | 207 | 47317-10 | 189 | 47357-42 | 204 | 47425-01 | 197 | 47532-18 | 221 | 47600-16 | 133 |
| 47068-15 | 226 | 47118-40 | 207 | 47317-12 | 189 | 47357-43 | 204 | 47425-02 | 197 | 47532-20 | 221 | 47600-20 | 133 |
| 47069-10 | 226 | 47118-55 | 207 | 47321-12 | 190 | 47357-44 | 204 | 47425-03 | 197 | 47532-22 | 221 | 47600-24 | 133 |
| 47069-12 | 226 | 47118-65 | 207 | 47322-12 | 190 | 47357-50 | 204 | 47425-04 | 197 | 47532-24 | 221 | 47600-28 | 133 |
| 47069-14 | 226 | 47117-04 | 203 | 47323-12 | 190 | 47357-51 | 204 | 47425-05 | 197 | 47532-26 | 221 | 47600-32 | 133 |
| 47069-16 | 226 | 47127-06 | 203 | 47324-12 | 190 | 47370-01 | 196 | 47425-06 | 197 | 47533-07 | 221 | 47600-36 | 133 |
| 47069-18 | 226 | 47127-08 | 203 | 47325-10 | 190 | 47370-02 | 196 | 47425-08 | 197 | 47533-08 | 221 | 47600-40 | 133 |
| 47069-20 | 226 | 47130-25 | 220 | 47326-10 | 190 | 47370-03 | 196 | 47425-09 | 197 | 47533-09 | 221 | 47603-25 | 127 |
| 47070-37 | 219 | 47130-30 | 220 | 47327-12 | 190 | 47370-08 | 191 | 47425-10 | 197 | 47533-10 | 221 | 47603-27 | 127 |
| 47070-48 | 219 | 47130-35 | 220 | 47328-15 | 190 | 47371-08 | 194 | 47425-11 | 197 | 47533-12 | 221 | 47604-08 | 128 |
| 47070-60 | 219 | 47130-40 | 220 | 47331-15 | 190 | 47372-08 | 192 | 47425-26 | 197 | 47533-14 | 221 | 47604-10 | 128 |
| 47074-01 | 219 | 47130-45 | 220 | 47332-12 | 190 | 47373-01 | 193 | 47425-29 | 197 | 47533-16 | 221 | 47604-12 | 128 |
| 47074-02 | 219 | 47130-50 | 220 | 47333-15 | 190 | 47373-02 | 196 | 47425-30 | 197 | 47533-18 | 221 | 47604-15 | 128 |
| 47074-03 | 219 | 47130-55 | 220 | 47334-12 | 190 | 47373-08 | 192 | 47425-32 | 197 | 47533-20 | 221 | 47604-18 | 128 |
| 47074-04 | 219 | 47130-60 | 220 | 47335-12 | 190 | 47374-01 | 195 | 47426-01 | 197 | 47533-22 | 221 | 47604-20 | 128 |
| 47074-05 | 219 | 47131-30 | 220 | 47336-42 | 190 | 47374-02 | 195 | 47426-07 | 197 | 47533-24 | 221 | 47604-24 | 128 |
| 47074-06 | 219 | 47131-60 | 220 | 47350-01 | 202 | 47374-08 | 195 | 47510-07 | 222 | 47533-26 | 221 | 47604-30 | 128 |
| 47074-07 | 219 | 47200-01 | 206 | 47351-01 | 202 | 47375-01 | 195 | 47510-09 | 222 | 47533-28 | 221 | 47605-23 | 127 |
| 47074-08 | 219 | 47200-02 | 206 | 47352-01 | 202 | 47375-08 | 195 | 47510-11 | 222 | 47533-30 | 221 | 47606-02 | 128 |
| 47075-20 | 218 | 47207-20 | 203 | 47353-02 | 203 | 47376-08 | 192 | 47510-13 | 222 | 47533-32 | 221 | 47606-05 | 128 |
| 47075-30 | 218 | 47207-25 | 203 | 47353-04 | 203 | 47377-01 | 194 | 47510-15 | 222 | 47534-00 | 221 | 47606-10 | 128 |
| 47075-45 | 218 | 47207-30 | 203 | 47353-06 | 203 | 47377-02 | 193 | 47510-17 | 222 | 47534-01 | 221 | 47606-20 | 128 |
| 47090-23 | 313 | 47208-01 | 202 | 47353-08 | 203 | 47377-03 | 193 | 47510-19 | 222 | 47534-06 | 221 | 47606-30 | 128 |
| 47092-01 | 313 | 47208-02 | 202 | 47353-10 | 203 | 47377-04 | 194 | 47510-21 | 222 | 47534-07 | 221 | 47606-50 | 128 |
| 47092-02 | 313 | 47208-03 | 202 | 47353-12 | 203 | 47377-05 | 194 | 47510-23 | 222 | 47534-08 | 221 | 47607-02 | 128 |
| 47093-24 | 138 | 47208-04 | 202 | 47353-14 | 203 | 47377-06 | 194 | 47510-25 | 222 | 47534-10 | 221 | 47607-05 | 128 |
| 47094-30 | 208 | 47208-05 | 202 | 47353-16 | 203 | 47377-08 | 191 | 47510-27 | 222 | 47534-16 | 221 | 47607-10 | 128 |
| 47098-18 | 209 | 47208-06 | 202 | 47353-18 | 203 | 47377-09 | 193 | 47510-29 | 222 | 47534-18 | 221 | 47607-20 | 128 |
| 47098-22 | 209 | 47208-07 | 202 | 47353-20 | 203 | 47377-10 | 193 | 47510-31 | 222 | 47534-20 | 221 | 47608-02 | 128 |
| 47098-26 | 209 | 47208-08 | 202 | 47353-22 | 203 | 47377-11 | 194 | 47511-07 | 222 | 47534-22 | 221 | 47609-02 | 129 |
| 47098-30 | 209 | 47208-09 | 202 | 47353-24 | 203 | 47377-12 | 197 | 47511-09 | 222 | 47534-24 | 221 | 47609-03 | 129 |
| 47099-30 | 309 | 47208-10 | 202 | 47354-02 | 203 | 47377-15 | 197 | 47511-11 | 222 | 47534-26 | 221 | 47609-04 | 129 |
| 47100-03 | 473 | 47208-11 | 202 | 47354-04 | 203 | 47378-01 | 196 | 47511-13 | 222 | 47534-28 | 221 | 47609-07 | 129 |
| 47100-04 | 473 | 47208-12 | 202 | 47354-06 | 203 | 47378-02 | 196 | 47511-15 | 222 | 47535-09 | 224 | 47609-09 | 129 |
| 47100-05 | 473 | 47208-13 | 202 | 47354-08 | 203 | 47378-08 | 191 | 47511-17 | 222 | 47535-12 | 224 | 47609-12 | 129 |
| 47100-06 | 473 | 47208-14 | 202 | 47354-10 | 203 | 47379-08 | 191 | 47511-19 | 222 | 47535-17 | 224 | 47609-13 | 129 |
| 47100-07 | 473 | 47208-15 | 202 | 47354-12 | 203 | 47380-08 | 195 | 47511-21 | 222 | 47535-19 | 224 | 47609-16 | 129 |
| 47100-08 | 473 | 47208-16 | 202 | 47354-14 | 203 | 47381-08 | 196 | 47511-23 | 222 | 47536-12 | 224 | 47610-18 | 132 |
| 47101-31 | 309 | 47208-17 | 203 | 47354-16 | 203 | 47382-06 | 194 | 47511-25 | 222 | 47536-14 | 224 | 47610-22 | 132 |
| 47101-40 | 208 | 47208-18 | 203 | 47354-18 | 203 | 47382-08 | 193 | 47511-27 | 222 | 47536-20 | 224 | 47610-26 | 132 |
| 47103-30 | 208 | 47208-19 | 203 | 47355-02 | 203 | 47383-08 | 195 | 47511-29 | 222 | 47538-23 | 224 | 47610-30 | 132 |
| 47103-32 | 208 | 47208-20 | 203 | 47355-04 | 203 | 47384-01 | 195 | 47511-31 | 222 | 47538-26 | 224 | 47611-01 | 133 |
| 47104-45 | 207 | 47208-21 | 203 | 47355-06 | 203 | 47384-08 | 195 | 47512-07 | 222 | 47540-02 | 224 | 47611-03 | 133 |
| 47105-28 | 206 | 47208-22 | 203 | 47355-08 | 203 | 47385-01 | 196 | 47512-09 | 222 | 47540-03 | 224 | 47611-05 | 133 |
| 47105-34 | 206 | 47208-23 | 203 | 47355-10 | 203 | 47385-08 | 196 | 47512-11 | 222 | 47540-04 | 224 | 47611-06 | 133 |
| 47105-40 | 206 | 47208-24 | 203 | 47355-12 | 203 | 47386-08 | 195 | 47512-13 | 222 | 47540-05 | 224 | 47611-09 | 133 |
| 47105-46 | 206 | 47212-01 | 205 | 47356-02 | 203 | 47387-01 | 192 | 47512-15 | 222 | 47541-02 | 223 | 47611-11 | 133 |
| 47105-50 | 206 | 47212-02 | 205 | 47356-04 | 203 | 47387-02 | 193 | 47512-17 | 222 | 47541-03 | 223 | 47611-13 | 133 |
| 47105-55 | 206 | 47212-03 | 205 | 47356-06 | 203 | 47388-06 | 197 | 47512-19 | 222 | 47541-04 | 223 | 47611-14 | 133 |
| 47105-60 | 206 | 47212-05 | 206 | 47356-08 | 203 | 47388-07 | 197 | 47512-21 | 222 | 47542-00 | 223 | 47611-15 | 133 |
| 47105-65 | 206 | 47214-86 | 204 | 47356-10 | 203 | 47388-08 | 197 | 47512-23 | 222 | 47542-18 | 224 | 47611-16 | 133 |
| 47105-70 | 206 | 47215-86 | 204 | 47356-12 | 203 | 47401-08 | 195 | 47512-25 | 222 | 47542-20 | 224 | 47611-19 | 133 |
| 47105-75 | 206 | 47219-29 | 205 | 47356-14 | 203 | 47402-01 | 192 | 47512-27 | 222 | 47542-22 | 224 | 47611-23 | 133 |
| 47106-28 | 206 | 47219-38 | 205 | 47356-16 | 203 | 47402-02 | 192 | 47512-29 | 222 | 47542-24 | 224 | 47612-01 | 210 |
| 47106-34 | 206 | 47219-55 | 205 | 47356-18 | 203 | 47402-08 | 192 | 47512-31 | 222 | 47542-26 | 224 | 47612-AA | 578 |
| 47106-40 | 206 | 47250-12 | 204 | 47357-02 | 201 | 47404-01 | 195 | 47526-05 | 223 | 47544-20 | 223 | 47614-25 | 218 |
| 47106-46 | 206 | 47250-24 | 204 | 47357-03 | 201 | 47404-02 | 195 | 47527-55 | 223 | 47544-25 | 223 | 47615-25 | 218 |
| 47106-50 | 206 | 47301-12 | 189 | 47357-06 | 200 | 47404-03 | 195 | 47528-05 | 223 | 47544-30 | 223 | 47618-10 | 204 |

| Cod. | pag. | Cod. | pag. | Cod. | pag. | Cod. | pag. | Cod. | pag. | Cod. | pag. | Cod. | pag. |
|----------|------|----------|------|----------|------|----------|------|----------|------|----------|------|----------|------|
| 47618-20 | 204 | 47658-03 | 235 | 47710-32 | 229 | 47740-13 | 261 | 47740-95 | 257 | 47742-24 | 253 | 47754-20 | 234 |
| 47621-01 | 217 | 47658-04 | 235 | 47711-08 | 229 | 47740-14 | 264 | 47740-96 | 264 | 47742-25 | 252 | 47754-24 | 234 |
| 47621-02 | 217 | 47658-05 | 235 | 47711-12 | 229 | 47740-15 | 262 | 47740-97 | 259 | 47742-27 | 251 | 47754-26 | 234 |
| 47621-03 | 217 | 47658-07 | 235 | 47711-22 | 229 | 47740-16 | 257 | 47740-98 | 263 | 47742-29 | 253 | 47754-28 | 234 |
| 47621-04 | 217 | 47659-01 | 234 | 47711-24 | 229 | 47740-17 | 259 | 47740-99 | 262 | 47742-30 | 251 | 47755-26 | 234 |
| 47621-05 | 217 | 47659-02 | 234 | 47711-26 | 229 | 47740-18 | 257 | 47740100 | 262 | 47742-31 | 251 | 47756-20 | 234 |
| 47621-06 | 217 | 47659-04 | 234 | 47712-20 | 229 | 47740-19 | 259 | 47740101 | 258 | 47742-33 | 253 | 47756-24 | 234 |
| 47621-07 | 218 | 47659-20 | 225 | 47712-24 | 229 | 47740-20 | 262 | 47740102 | 256 | 47742-34 | 252 | 47756-26 | 234 |
| 47621-08 | 218 | 47659-21 | 225 | 47712-28 | 229 | 47740-23 | 256 | 47740103 | 257 | 47742-37 | 252 | 47756-28 | 234 |
| 47621-11 | 301 | 47659-22 | 225 | 47712-32 | 229 | 47740-24 | 261 | 47740104 | 260 | 47742-41 | 251 | 47757-65 | 231 |
| 47621-12 | 302 | 47659-24 | 225 | 47713-22 | 229 | 47740-25 | 261 | 47740105 | 256 | 47742-42 | 252 | 47757-80 | 231 |
| 47622-01 | 198 | 47659-25 | 225 | 47714-26 | 230 | 47740-26 | 256 | 47740106 | 259 | 47742-47 | 253 | 47758-10 | 230 |
| 47622-02 | 198 | 47659-26 | 225 | 47714-28 | 230 | 47740-27 | 256 | 47740107 | 264 | 47742-48 | 253 | 47758-12 | 230 |
| 47622-03 | 198 | 47670-02 | 234 | 47715-30 | 230 | 47740-28 | 256 | 47740108 | 264 | 47742-51 | 252 | 47759-12 | 231 |
| 47622-04 | 198 | 47672-05 | 234 | 47717-35 | 230 | 47740-29 | 256 | 47740109 | 264 | 47742-56 | 252 | 47761-23 | 233 |
| 47622-26 | 198 | 47679-10 | 218 | 47718-20 | 230 | 47740-30 | 261 | 47740110 | 264 | 47742-61 | 253 | 47762-23 | 233 |
| 47625-03 | 218 | 47679-11 | 218 | 47719-10 | 230 | 47740-31 | 263 | 47740111 | 260 | 47743-03 | 265 | 47764-12 | 233 |
| 47626-55 | 213 | 47680-40 | 220 | 47719-24 | 230 | 47740-32 | 260 | 47740112 | 265 | 47743-05 | 265 | 47764-28 | 234 |
| 47627-01 | 213 | 47680-53 | 220 | 47720-06 | 231 | 47740-33 | 263 | 47740113 | 265 | 47743-10 | 265 | 47765-24 | 253 |
| 47630-28 | 198 | 47680-60 | 220 | 47720-08 | 231 | 47740-34 | 260 | 47740114 | 262 | 47743-13 | 265 | 47765-26 | 253 |
| 47631-08 | 198 | 47681-60 | 219 | 47720-10 | 231 | 47740-35 | 265 | 47740115 | 263 | 47743-15 | 268 | 47765-28 | 253 |
| 47631-12 | 198 | 47682-40 | 219 | 47720-12 | 231 | 47740-36 | 261 | 47740116 | 264 | 47743-16 | 268 | 47766-26 | 253 |
| 47640-25 | 217 | 47682-53 | 219 | 47721-08 | 231 | 47740-37 | 258 | 47740117 | 264 | 47744-01 | 270 | 47766-28 | 253 |
| 47640-35 | 217 | 47682-60 | 219 | 47721-10 | 231 | 47740-38 | 258 | 47740122 | 258 | 47744-02 | 269 | 47766-30 | 253 |
| 47640-50 | 217 | 47683-01 | 272 | 47721-12 | 231 | 47740-39 | 261 | 47740123 | 258 | 47744-03 | 270 | 47769-28 | 254 |
| 47640-59 | 217 | 47683-02 | 272 | 47722-05 | 232 | 47740-41 | 258 | 47740124 | 258 | 47744-04 | 269 | 47770-21 | 254 |
| 47642-30 | 217 | 47683-03 | 272 | 47722-06 | 232 | 47740-43 | 257 | 47740125 | 258 | 47744-05 | 269 | 47771-28 | 254 |
| 47642-40 | 217 | 47685-53 | 220 | 47722-07 | 232 | 47740-44 | 260 | 47740127 | 257 | 47744-06 | 269 | 47773-24 | 254 |
| 47642-50 | 217 | 47685-60 | 220 | 47722-08 | 232 | 47740-45 | 261 | 47740128 | 256 | 47744-07 | 269 | 47773-28 | 254 |
| 47642-60 | 217 | 47685-61 | 272 | 47722-10 | 232 | 47740-46 | 260 | 47740130 | 258 | 47744-10 | 270 | 47783-01 | 236 |
| 47642-70 | 217 | 47686-10 | 208 | 47723-05 | 232 | 47740-47 | 260 | 47740131 | 259 | 47744-19 | 270 | 47783-02 | 236 |
| 47644-30 | 217 | 47686-12 | 208 | 47723-06 | 232 | 47740-48 | 260 | 47740132 | 257 | 47744-21 | 270 | 47783-03 | 236 |
| 47644-40 | 217 | 47686-14 | 208 | 47723-07 | 232 | 47740-49 | 260 | 47740133 | 259 | 47744-30 | 268 | 47783-04 | 236 |
| 47644-50 | 217 | 47686-17 | 208 | 47723-08 | 232 | 47740-50 | 259 | 47740134 | 265 | 47744-31 | 268 | 47783-11 | 236 |
| 47644-60 | 217 | 47686-22 | 208 | 47723-10 | 232 | 47740-51 | 262 | 47740135 | 257 | 47744-32 | 268 | 47783-12 | 236 |
| 47644-70 | 217 | 47686-24 | 208 | 47723-12 | 232 | 47740-52 | 256 | 47740142 | 259 | 47744-34 | 268 | 47783-13 | 236 |
| 47645-40 | 217 | 47686-26 | 208 | 47724-06 | 232 | 47740-53 | 264 | 47740143 | 259 | 47744-36 | 270 | 47783-14 | 236 |
| 47645-60 | 217 | 47686-30 | 208 | 47724-08 | 232 | 47740-55 | 260 | 47740144 | 259 | 47744-37 | 271 | 47793-12 | 248 |
| 47645-75 | 217 | 47686-33 | 208 | 47724-10 | 232 | 47740-56 | 262 | 47740145 | 262 | 47744-48 | 269 | 47793-13 | 248 |
| 47646-40 | 217 | 47686-36 | 208 | 47724-11 | 232 | 47740-57 | 257 | 47741-00 | 268 | 47744-58 | 269 | 47793-15 | 248 |
| 47646-60 | 217 | 47686-42 | 208 | 47725-09 | 232 | 47740-58 | 257 | 47741-01 | 268 | 47744-59 | 269 | 47793-23 | 248 |
| 47646-75 | 217 | 47687-24 | 208 | 47726-07 | 231 | 47740-59 | 257 | 47741-02 | 268 | 47744-60 | 269 | 47793-26 | 248 |
| 47651-01 | 235 | 47688-60 | 220 | 47727-07 | 231 | 47740-60 | 257 | 47741-05 | 268 | 47744-62 | 269 | 47793-33 | 248 |
| 47651-02 | 235 | 47689-53 | 220 | 47728-06 | 231 | 47740-62 | 261 | 47741-07 | 266 | 47744-70 | 271 | 47793-40 | 248 |
| 47651-03 | 235 | 47689-60 | 220 | 47730-60 | 232 | 47740-63 | 261 | 47741-11 | 266 | 47744-71 | 271 | 47793-43 | 248 |
| 47651-04 | 235 | 47691-53 | 219 | 47731-12 | 233 | 47740-64 | 261 | 47741-13 | 266 | 47744-81 | 269 | 47793-45 | 248 |
| 47651-05 | 235 | 47691-64 | 219 | 47732-20 | 233 | 47740-65 | 261 | 47741-15 | 266 | 47745-02 | 250 | 47793-52 | 248 |
| 47651-07 | 235 | 47692-03 | 214 | 47733-18 | 230 | 47740-66 | 261 | 47741-20 | 266 | 47745-03 | 250 | 47793-55 | 248 |
| 47652-01 | 235 | 47692-11 | 214 | 47733-24 | 230 | 47740-67 | 263 | 47741-37 | 268 | 47745-04 | 250 | 47800-22 | 210 |
| 47652-02 | 235 | 47692-22 | 214 | 47733-30 | 230 | 47740-68 | 259 | 47741-38 | 268 | 47745-05 | 250 | 47801-20 | 210 |
| 47652-03 | 235 | 47692-25 | 214 | 47733-36 | 230 | 47740-69 | 256 | 47741-76 | 265 | 47745-06 | 249 | 47820-05 | 215 |
| 47652-04 | 235 | 47693-00 | 213 | 47734-18 | 230 | 47740-70 | 256 | 47741-77 | 266 | 47745-07 | 249 | 47820-07 | 215 |
| 47652-05 | 235 | 47693-03 | 214 | 47735-18 | 230 | 47740-71 | 261 | 47741-78 | 265 | 47745-08 | 249 | 47821-05 | 215 |
| 47652-07 | 235 | 47693-05 | 214 | 47736-30 | 231 | 47740-72 | 261 | 47742-00 | 254 | 47745-09 | 249 | 47821-07 | 215 |
| 47655-01 | 235 | 47693-10 | 214 | 47736-35 | 231 | 47740-73 | 264 | 47742-01 | 253 | 47745-10 | 249 | 47822-05 | 215 |
| 47655-02 | 235 | 47693-15 | 214 | 47736-40 | 231 | 47740-74 | 257 | 47742-02 | 251 | 47746-01 | 250 | 47822-07 | 215 |
| 47655-03 | 235 | 47694-03 | 210 | 47736-50 | 231 | 47740-75 | 257 | 47742-03 | 253 | 47746-02 | 250 | 47831-02 | 130 |
| 47655-04 | 235 | 47698-01 | 563 | 47738-23 | 230 | 47740-77 | 259 | 47742-04 | 253 | 47746-03 | 250 | 47832-00 | 488 |
| 47655-05 | 235 | 47698-01 | 211 | 47739-12 | 229 | 47740-79 | 262 | 47742-05 | 253 | 47746-04 | 250 | 47832-01 | 317 |
| 47655-07 | 235 | 47698-02 | 211 | 47739-24 | 229 | 47740-80 | 256 | 47742-06 | 253 | 47747-01 | 232 | 47832-02 | 488 |
| 47656-01 | 235 | 47698-03 | 212 | 47739-28 | 229 | 47740-81 | 260 | 47742-07 | 253 | 47747-03 | 232 | 47832-03 | 317 |
| 47656-02 | 235 | 47698-06 | 564 | 47739-32 | 229 | 47740-82 | 259 | 47742-08 | 253 | 47747-04 | 232 | 47832-04 | 317 |
| 47656-03 | 235 | 47698-06 | 212 | 47740-01 | 262 | 47740-83 | 257 | 47742-09 | 252 | 47747-05 | 233 | 47832-05 | 317 |
| 47656-04 | 235 | 47698-07 | 212 | 47740-02 | 258 | 47740-84 | 263 | 47742-10 | 253 | 47747-06 | 232 | 47832-10 | 488 |
| 47656-05 | 235 | 47705-22 | 230 | 47740-03 | 258 | 47740-85 | 261 | 47742-12 | 251 | 47747-07 | 233 | 47832-11 | 488 |
| 47656-07 | 235 | 47709-20 | 229 | 47740-04 | 260 | 47740-86 | 264 | 47742-13 | 252 | 47747-09 | 233 | 47832-12 | 488 |
| 47657-01 | 235 | 47709-24 | 229 | 47740-05 | 261 | 47740-87 | 262 | 47742-14 | 252 | 47747-10 | 232 | 47832-13 | 488 |
| 47657-02 | 235 | 47709-28 | 229 | 47740-06 | 256 | 47740-88 | 264 | 47742-15 | 253 | 47747-11 | 232 | 47832-14 | 488 |
| 47657-03 | 235 | 47709-32 | 229 | 47740-07 | 263 | 47740-89 | 258 | 47742-16 | 253 | 47748-35 | 233 | 47832-15 | 488 |
| 47657-04 | 235 | 47710-12 | 229 | 47740-08 | 263 | 47740-90 | 263 | 47742-17 | 252 | 47749-35 | 233 | 47833-04 | 199 |
| 47657-05 | 235 | 47710-16 | 229 | 47740-09 | 262 | 47740-91 | 263 | 47742-19 | 252 | 47750-06 | 233 | 47833-10 | 198 |
| 47657-07 | 235 | 47710-20 | 229 | 47740-10 | 257 | 47740-92 | 260 | 47742-20 | 252 | 47752-16 | 231 | 47837-09 | 198 |
| 47658-01 | 235 | 47710-24 | 229 | 47740-11 | 263 | 47740-93 | 256 | 47742-21 | 252 | 47752-21 | 231 | 47838-00 | 212 |
| 47658-02 | 235 | 47710-28 | 229 | 47740-12 | 263 | 47740-94 | 258 | 47742-23 | 252 | 47753-31 | 231 | 47840-11 | 211 |

NUMERICAL INDEX INDICE NUMERICO NUMERISCH INDEX INDEX NUMERIQUE INDICE NUMERICO

| Cod. | pag. | Cod. | pag. | Cod. | pag. | Cod. | pag. | Cod. | pag. | Cod. | pag. | Cod. | pag. |
|----------|------|----------|------|----------|------|----------|------|----------|------|----------|------|----------|------|
| 47841-03 | 212 | 47861-11 | 238 | 47865-44 | 246 | 48252-12 | 408 | 48280-02 | 177 | 48290-10 | 275 | 48516-08 | 187 |
| 47841-04 | 212 | 47861-12 | 238 | 47865-66 | 246 | 48252B10 | 408 | 48280-03 | 109 | 48294-01 | 144 | 48516-09 | 187 |
| 47842-00 | 212 | 47861-13 | 238 | 47865-71 | 246 | 48252B12 | 408 | 48280-03 | 146 | 48294-02 | 144 | 48517-03 | 187 |
| 47843-00 | 149 | 47861-14 | 238 | 47865-72 | 246 | 48253B09 | 407 | 48280-04 | 107 | 48294-03 | 144 | 48518-01 | 187 |
| 47843-05 | 149 | 47861-15 | 238 | 47865-73 | 246 | 48255-01 | 407 | 48280-05 | 107 | 48294-04 | 144 | 48518-02 | 187 |
| 47844-01 | 211 | 47861-16 | 244 | 47865-74 | 246 | 48255-04 | 407 | 48280-06 | 108 | 48295-10 | 141 | 48519-01 | 187 |
| 47844-02 | 211 | 47861-17 | 245 | 47865-75 | 246 | 48278-01 | 113 | 48280-08 | 110 | 48300-29 | 285 | 48519-02 | 187 |
| 47844-06 | 211 | 47861-18 | 245 | 47865-76 | 246 | 48278-02 | 114 | 48280-09 | 108 | 48300-33 | 286 | 48519-03 | 187 |
| 47847-10 | 210 | 47861-19 | 245 | 47865-77 | 246 | 48278-03 | 114 | 48280-10 | 109 | 48300-42 | 286 | 48519-04 | 187 |
| 47847-12 | 210 | 47861-20 | 237 | 47865-80 | 246 | 48278-11 | 115 | 48280-10 | 137 | 48300-43 | 286 | 48523-01 | 186 |
| 47847-23 | 211 | 47861-21 | 237 | 47865-81 | 246 | 48278-12 | 112 | 48280-11 | 110 | 48306-01 | 358 | 48523-02 | 186 |
| 47848-07 | 211 | 47861-22 | 242 | 47865-82 | 246 | 48278-13 | 112 | 48280-12 | 108 | 48307-01 | 179 | 48523-03 | 186 |
| 47859-01 | 305 | 47861-23 | 242 | 47865-83 | 246 | 48278-14 | 117 | 48280-13 | 108 | 48307-02 | 179 | 48523-04 | 186 |
| 47859-02 | 305 | 47861-24 | 242 | 47870-50 | 242 | 48278-15 | 115 | 48280-15 | 110 | 48307-03 | 179 | 48524-01 | 186 |
| 47859-03 | 305 | 47861-25 | 237 | 47870-51 | 242 | 48278-16 | 115 | 48280-20 | 107 | 48310-14 | 333 | 48524-02 | 186 |
| 47860-17 | 238 | 47861-26 | 237 | 47870-52 | 242 | 48278-17 | 114 | 48280-21 | 107 | 48310-20 | 333 | 48524-03 | 186 |
| 47860-18 | 238 | 47861-27 | 237 | 47870-53 | 242 | 48278-18 | 117 | 48280-23 | 111 | 48311-20 | 333 | 48543-01 | 353 |
| 47860-21 | 238 | 47861-28 | 237 | 47876-11 | 246 | 48278-19 | 117 | 48280-24 | 109 | 48311-25 | 333 | 48543-02 | 353 |
| 47860-24 | 238 | 47861-29 | 237 | 47876-12 | 246 | 48278-20 | 113 | 48280-25 | 111 | 48312-25 | 333 | 49304-06 | 519 |
| 47860-27 | 239 | 47861-30 | 237 | 47876-13 | 246 | 48278-21 | 113 | 48280-25 | 177 | 48313-14 | 334 | 49335-01 | 538 |
| 47860-31 | 239 | 47861-31 | 238 | 47876-14 | 246 | 48278-24 | 111 | 48280-26 | 109 | 48313-18 | 334 | 49335-02 | 538 |
| 47860-35 | 239 | 47861-32 | 238 | 47885-01 | 143 | 48278-25 | 114 | 48280-27 | 177 | 48350-01 | 322 | 49336-00 | 538 |
| 47860-36 | 239 | 47861-33 | 242 | 47885-02 | 143 | 48278-27 | 116 | 48280-30 | 109 | 48350-02 | 322 | 49336-02 | 538 |
| 47860-37 | 239 | 47861-34 | 242 | 47885-03 | 143 | 48278-28 | 117 | 48280-31 | 109 | 48350-03 | 322 | 49337-00 | 538 |
| 47860-38 | 239 | 47862-03 | 243 | 47885-04 | 143 | 48278-31 | 113 | 48280-32 | 107 | 48350-04 | 322 | 49337-01 | 538 |
| 47860-39 | 239 | 47862-04 | 243 | 47885-05 | 143 | 48278-32 | 111 | 48280-34 | 110 | 48351-01 | 322 | 49371-09 | 544 |
| 47860-40 | 239 | 47862-05 | 243 | 48017-14 | 172 | 48278-33 | 111 | 48280-34 | 177 | 48351-02 | 322 | 49371-12 | 544 |
| 47860-42 | 239 | 47862-06 | 244 | 48017-25 | 172 | 48278-34 | 114 | 48280-35 | 109 | 48351-03 | 322 | 49372-01 | 523 |
| 47860-43 | 239 | 47862-07 | 244 | 48021-21 | 171 | 48278-35 | 114 | 48280-36 | 109 | 48352-01 | 321 | 49372-02 | 523 |
| 47860-44 | 239 | 47862-08 | 244 | 48032-30 | 178 | 48278-36 | 115 | 48280-37 | 108 | 48352-02 | 321 | 49372-03 | 523 |
| 47860-46 | 239 | 47862-09 | 244 | 48032-45 | 178 | 48278-37 | 113 | 48280-38 | 107 | 48352-03 | 321 | 49372-04 | 523 |
| 47860-48 | 239 | 47862-10 | 244 | 48032-60 | 178 | 48278-38 | 111 | 48280-39 | 107 | 48353-01 | 320 | 49372-05 | 523 |
| 47860-49 | 239 | 47862-31 | 241 | 48039-06 | 179 | 48278-39 | 111 | 48280-41 | 108 | 48354-01 | 320 | 49372-06 | 523 |
| 47860-50 | 239 | 47862-32 | 241 | 48040-00 | 178 | 48278-41 | 112 | 48280-45 | 107 | 48355-01 | 372 | 49372-11 | 523 |
| 47860-53 | 239 | 47862-33 | 241 | 48040-10 | 179 | 48278-42 | 112 | 48280-45 | 294 | 48356-01 | 373 | 49372-12 | 523 |
| 47860-55 | 239 | 47862-34 | 241 | 48040-50 | 179 | 48278-45 | 113 | 48280-46 | 108 | 48357-01 | 372 | 49372-13 | 523 |
| 47860-56 | 239 | 47862-35 | 241 | 48040-AA | 578 | 48278-46 | 112 | 48280-47 | 110 | 48358-01 | 373 | 49372-14 | 523 |
| 47860-58 | 240 | 47862-36 | 241 | 48210-00 | 400 | 48278-47 | 114 | 48280-48 | 107 | 48359-01 | 372 | 49372-15 | 523 |
| 47860-60 | 240 | 47862-38 | 241 | 48211-00 | 400 | 48278-48 | 112 | 48280-49 | 108 | 48365-09 | 321 | 49372-16 | 523 |
| 47860-61 | 240 | 47862-39 | 241 | 48215-14 | 172 | 48278-49 | 112 | 48280-52 | 110 | 48366-09 | 322 | 49372-24 | 523 |
| 47860-62 | 240 | 47862-64 | 243 | 48215-30 | 172 | 48278-52 | 114 | 48280-53 | 110 | 48367-10 | 320 | 49373-05 | 544 |
| 47860-63 | 240 | 47862-65 | 243 | 48218-00 | 137 | 48278-53 | 114 | 48280-54 | 109 | 48368-05 | 372 | 49378-00 | 536 |
| 47860-66 | 240 | 47862-66 | 243 | 48220-00 | 146 | 48278-54 | 114 | 48280-59 | 108 | 48368-12 | 372 | 49379-00 | 536 |
| 47860-67 | 240 | 47862-67 | 243 | 48222-01 | 145 | 48278-55 | 112 | 48280-60 | 110 | 48368-20 | 372 | 49380-80 | 523 |
| 47860-68 | 240 | 47862-70 | 244 | 48223-00 | 357 | 48278-61 | 116 | 48280-61 | 110 | 48369-08 | 372 | 49381-01 | 523 |
| 47860-69 | 240 | 47862-72 | 244 | 48231-40 | 181 | 48278-62 | 116 | 48280-62 | 110 | 48369-14 | 372 | 49381-02 | 523 |
| 47860-70 | 240 | 47862-74 | 244 | 48231-45 | 181 | 48278-63 | 116 | 48280-63 | 110 | 48369-20 | 372 | 49381-03 | 523 |
| 47860-71 | 240 | 47862-80 | 246 | 48231-50 | 181 | 48278-64 | 115 | 48280-75 | 108 | 48370-10 | 321 | 49383-08 | 522 |
| 47860-73 | 240 | 47862-81 | 246 | 48232-40 | 578 | 48278-65 | 116 | 48280-85 | 109 | 48370-11 | 321 | 49383-20 | 522 |
| 47860-74 | 240 | 47862-82 | 246 | 48232-45 | 578 | 48278-66 | 115 | 48280-90 | 111 | 48371-10 | 320 | 49383-40 | 522 |
| 47860-75 | 240 | 47862-83 | 246 | 48232-50 | 578 | 48278-68 | 115 | 48280-91 | 110 | 48371-11 | 320 | 49384-03 | 522 |
| 47860-76 | 244 | 47862-84 | 246 | 48236-00 | 394 | 48278-69 | 115 | 48280-92 | 111 | 48371-12 | 320 | 49384-04 | 522 |
| 47860-77 | 245 | 47862-85 | 246 | 48236-01 | 394 | 48278-71 | 116 | 48280-92 | 177 | 48371C12 | 320 | 49384-05 | 522 |
| 47860-78 | 245 | 47862-86 | 246 | 48237-00 | 394 | 48278-73 | 116 | 48280-94 | 108 | 48372-08 | 372 | 49384-07 | 522 |
| 47860-81 | 240 | 47862-87 | 245 | 48237-01 | 394 | 48278-74 | 116 | 48280-95 | 111 | 48501-76 | 185 | 49384-11 | 522 |
| 47860-83 | 240 | 47862-88 | 245 | 48237-35 | 395 | 48278-75 | 113 | 48280-96 | 110 | 48505-01 | 185 | 49384-14 | 522 |
| 47860-84 | 240 | 47862-89 | 245 | 48237-99 | 394 | 48278-76 | 116 | 48280-97 | 110 | 48505-02 | 185 | 49384-15 | 522 |
| 47860-85 | 241 | 47862C10 | 244 | 48238-00 | 400 | 48278-77 | 113 | 48281-22 | 140 | 48505-03 | 185 | 49603-15 | 287 |
| 47860-86 | 244 | 47863-10 | 247 | 48239-00 | 400 | 48278-81 | 117 | 48282-21 | 140 | 48506-01 | 185 | 49603-20 | 287 |
| 47860-89 | 241 | 47863-11 | 247 | 48240-00 | 400 | 48278-82 | 117 | 48286-03 | 143 | 48506-02 | 185 | 49603-25 | 287 |
| 47860-95 | 241 | 47863-12 | 247 | 48241-14 | 408 | 48278-83 | 117 | 48286-08 | 143 | 48506-03 | 185 | 49603-30 | 287 |
| 47860-96 | 241 | 47863-13 | 247 | 48242-09 | 408 | 48278-84 | 117 | 48286-13 | 143 | 48507-38 | 186 | 49603-40 | 287 |
| 47860-97 | 241 | 47863-14 | 247 | 48244-04 | 408 | 48278-85 | 117 | 48286-62 | 139 | 48507-43 | 186 | 49603-50 | 287 |
| 47860-98 | 241 | 47863-15 | 247 | 48244-07 | 408 | 48278-87 | 113 | 48286-64 | 139 | 48507P38 | 186 | 49604-31 | 287 |
| 47860-99 | 241 | 47863-16 | 247 | 48245-10 | 408 | 48278-88 | 117 | 48286-67 | 109 | 48508-43 | 186 | 49604-36 | 287 |
| 47861-02 | 238 | 47863-17 | 247 | 48245-75 | 408 | 48278-89 | 117 | 48286-67 | 177 | 48509-33 | 186 | 49604-41 | 287 |
| 47861-03 | 238 | 47863-20 | 247 | 48247-10 | 407 | 48278-91 | 115 | 48286-68 | 400 | 48509-43 | 186 | 49605-46 | 287 |
| 47861-04 | 238 | 47863-21 | 247 | 48249-10 | 407 | 48278-92 | 115 | 48286-70 | 142 | 48509K43 | 186 | 49605-61 | 287 |
| 47861-05 | 238 | 47863-22 | 247 | 48249-12 | 407 | 48278-93 | 116 | 48287-18 | 407 | 48510-00 | 185 | 49605-71 | 287 |
| 47861-06 | 238 | 47863-23 | 247 | 48249-13 | 407 | 48278-94 | 113 | 48287-19 | 407 | 48511-02 | 187 | 49606-00 | 288 |
| 47861-07 | 238 | 47863-24 | 247 | 48250-10 | 407 | 48278-95 | 114 | 48288-02 | 139 | 48512-02 | 187 | 49606-01 | 288 |
| 47861-08 | 238 | 47863-25 | 247 | 48250-12 | 407 | 48278-96 | 114 | 48288-03 | 139 | 48513-02 | 187 | 49606-51 | 288 |
| 47861-09 | 238 | 47863-26 | 247 | 48251-03 | 407 | 48278-99 | 115 | 48288-05 | 139 | 48514-00 | 185 | 49607-15 | 289 |
| 47861-10 | 238 | 47865-23 | 246 | 48252-10 | 408 | 48280-02 | 109 | 48289-10 | 138 | 48516-07 | 187 | 49607-20 | 289 |

| Cod. | pag. | Cod. | pag. | Cod. | pag. | Cod. | pag. | Cod. | pag. | Cod. | pag. | Cod. | pag. |
|----------|------|----------|------|----------|------|----------|------|----------|------|----------|------|----------|------|
| 49607-25 | 289 | 49657-31 | 284 | 49821-08 | 137 | 49850-75 | 550 | 49922-04 | 557 | 49975-25 | 565 | 66345-65 | 476 |
| 49607-30 | 289 | 49657-32 | 283 | 49823-00 | 142 | 49850-76 | 550 | 49922-06 | 557 | 49975-30 | 565 | 66345-74 | 476 |
| 49608-15 | 289 | 49657-33 | 283 | 49823-89 | 142 | 49851-10 | 560 | 49922-08 | 557 | 49975-35 | 565 | 66362-02 | 396 |
| 49608-20 | 289 | 49657-34 | 284 | 49823-99 | 142 | 49855-05 | 506 | 49922-09 | 558 | 49975U19 | 565 | 66374-00 | 307 |
| 49608-25 | 289 | 49657-35 | 284 | 49827-03 | 143 | 49855-10 | 506 | 49922-20 | 558 | 49975U22 | 565 | 66391-00 | 308 |
| 49608-30 | 289 | 49657-36 | 284 | 49827-77 | 142 | 49855-15 | 507 | 49922-21 | 558 | 49975U25 | 565 | 67303-64 | 307 |
| 49608-35 | 289 | 49657-37 | 283 | 49827-99 | 142 | 49856-04 | 506 | 49922-22 | 557 | 49975U30 | 565 | XO1046 | 580 |
| 49609-12 | 289 | 49658-01 | 285 | 49829-11 | 141 | 49858-07 | 357 | 49922-23 | 557 | 49975U35 | 565 | | |
| 49609-14 | 289 | 49658-02 | 285 | 49829-BA | 579 | 49860-00 | 358 | 49923-00 | 348 | 49978-10 | 182 | | |
| 49610-11 | 289 | 49701-00 | 150 | 49830-00 | 579 | 49863-15 | 156 | 49923-01 | 348 | 49978-13 | 182 | | |
| 49610-14 | 289 | 49702-00 | 150 | 49830-02 | 579 | 49863-30 | 156 | 49923-02 | 348 | 49979-03 | 552 | | |
| 49614-15 | 287 | 49703-00 | 153 | 49830-60 | 141 | 49863-50 | 156 | 49923-99 | 348 | 49986-00 | 151 | | |
| 49614-20 | 287 | 49703-01 | 212 | 49830-AA | 579 | 49863-AA | 156 | 49924-21 | 349 | 49987-00 | 151 | | |
| 49614-25 | 287 | 49705-00 | 149 | 49830-AB | 579 | 49864-03 | 155 | 49924-31 | 349 | 49988-00 | 151 | | |
| 49614-30 | 287 | 49709-03 | 149 | 49830-AC | 579 | 49864-05 | 155 | 49924-36 | 349 | 49993-01 | 553 | | |
| 49614-40 | 287 | 49710-00 | 150 | 49831-10 | 140 | 49864-20 | 155 | 49929R30 | 543 | 49993-02 | 553 | | |
| 49614-50 | 287 | 49711-00 | 151 | 49832-02 | 140 | 49867-01 | 147 | 49929R45 | 543 | 49993-03 | 553 | | |
| 49618-12 | 288 | 49712-00 | 149 | 49832-10 | 140 | 49867-02 | 147 | 49929R68 | 543 | 49993-11 | 554 | | |
| 49618-15 | 288 | 49715-00 | 150 | 49832-80 | 579 | 49871-10 | 566 | 49929R87 | 543 | 49993-12 | 554 | | |
| 49618-18 | 288 | 49716-00 | 150 | 49832-86 | 579 | 49871-20 | 566 | 49929W30 | 543 | 49993-13 | 554 | | |
| 49626-00 | 286 | 49717-00 | 151 | 49832-88 | 579 | 49872-00 | 566 | 49929W45 | 543 | 49993-21 | 553 | | |
| 49626-02 | 286 | 49719-00 | 153 | 49832-90 | 579 | 49875-06 | 178 | 49929W87 | 543 | 49993-22 | 553 | | |
| 49627-22 | 286 | 49720-00 | 153 | 49832-96 | 579 | 49876-03 | 182 | 49931-00 | 542 | 49993-23 | 553 | | |
| 49630-06 | 551 | 49721-03 | 153 | 49832-98 | 579 | 49879-37 | 146 | 49931-60 | 542 | 49995-04 | 511 | | |
| 49634-00 | 289 | 49727-00 | 155 | 49833-00 | 487 | 49879-90 | 580 | 49931-64 | 542 | 49996-00 | 512 | | |
| 49636-00 | 174 | 49728-00 | 151 | 49834-00 | 138 | 49879-91 | 580 | 49931-87 | 542 | 49996-01 | 512 | | |
| 49655-02 | 286 | 49729-00 | 152 | 49834-01 | 579 | 49879-92 | 580 | 49931A00 | 542 | 49996-05 | 512 | | |
| 49655-24 | 282 | 49730-00 | 153 | 49834-02 | 579 | 49879-93 | 580 | 49931B05 | 542 | 49997-12 | 560 | | |
| 49655-27 | 286 | 49730-20 | 153 | 49835-00 | 138 | 49879-94 | 580 | 49931C04 | 542 | 49997-13 | 560 | | |
| 49655-29 | 282 | 49731-10 | 154 | 49836-00 | 138 | 49880-10 | 152 | 49933-50 | 543 | 49998-20 | 561 | | |
| 49655-31 | 282 | 49731-99 | 154 | 49837-05 | 136 | 49880-11 | 152 | 49934-04 | 544 | 49998-35 | 560 | | |
| 49655-34 | 279 | 49733-00 | 153 | 49837-AA | 580 | 49880-12 | 152 | 49934-06 | 544 | 49999-04 | 52 | | |
| 49655-39 | 281 | 49734-00 | 153 | 49838-08 | 137 | 49880-13 | 152 | 49934-08 | 544 | 52550F63 | 572 | | |
| 49655-41 | 281 | 49735-00 | 153 | 49838-98 | 137 | 49880-14 | 152 | 49934-14 | 544 | 52550F73 | 572 | | |
| 49655-49 | 287 | 49739-00 | 177 | 49838-AB | 580 | 49880-15 | 152 | 49934-16 | 544 | 52550F78 | 572 | | |
| 49655-50 | 287 | 49741-07 | 566 | 49842-00 | 137 | 49880-17 | 152 | 49934-18 | 544 | 52550F80 | 572 | | |
| 49655-67 | 282 | 49741-15 | 566 | 49843-05 | 145 | 49881-01 | 152 | 49940-01 | 556 | 52550F88 | 572 | | |
| 49655-68 | 282 | 49750-00 | 138 | 49844-01 | 145 | 49881-02 | 152 | 49942-01 | 556 | 56345-AA | 311 | | |
| 49655-69 | 282 | 49752-00 | 142 | 49845-01 | 136 | 49881-11 | 152 | 49942-03 | 556 | 66303-01 | 306 | | |
| 49655-70 | 284 | 49753-06 | 142 | 49846-05 | 507 | 49881-99 | 152 | 49943-01 | 555 | 66303-03 | 306 | | |
| 49655-72 | 284 | 49753-09 | 142 | 49846-09 | 507 | 49883-00 | 150 | 49943-02 | 555 | 66303-06 | 306 | | |
| 49655-73 | 282 | 49760-00 | 136 | 49846-15 | 561 | 49884-08 | 151 | 49944-01 | 555 | 66307-06 | 306 | | |
| 49655-80 | 285 | 49771-00 | 156 | 49846-15 | 507 | 49885-02 | 149 | 49944-02 | 555 | 66307-09 | 306 | | |
| 49655-81 | 285 | 49772-01 | 156 | 49847-08 | 507 | 49887-00 | 149 | 49945-05 | 559 | 66307-12 | 306 | | |
| 49655-86 | 285 | 49773-05 | 155 | 49847-38 | 507 | 49887-02 | 150 | 49946-01 | 556 | 66313-03 | 306 | | |
| 49655-89 | 286 | 49774-05 | 156 | 49850-03 | 553 | 49888-10 | 134 | 49947-08 | 559 | 66313-06 | 307 | | |
| 49655-90 | 287 | 49775-05 | 156 | 49850-06 | 551 | 49888-20 | 134 | 49949-09 | 557 | 66318-19 | 308 | | |
| 49655B91 | 285 | 49775-10 | 156 | 49850-10 | 551 | 49889-09 | 132 | 49949-19 | 551 | 66318-22 | 308 | | |
| 49655G91 | 285 | 49776-15 | 156 | 49850-11 | 550 | 49889-12 | 132 | 49949-20 | 555 | 66320-28 | 476 | | |
| 49655R70 | 284 | 49776-30 | 156 | 49850-13 | 549 | 49889-15 | 132 | 49953-02 | 552 | 66320-35 | 476 | | |
| 49656B04 | 281 | 49777-50 | 156 | 49850-14 | 549 | 49892-40 | 544 | 49954-20 | 559 | 66320-40 | 476 | | |
| 49656B06 | 281 | 49779-15 | 156 | 49850-18 | 549 | 49899-01 | 543 | 49954-21 | 559 | 66320-50 | 476 | | |
| 49656B07 | 280 | 49779-30 | 156 | 49850-19 | 548 | 49899-91 | 543 | 49955-01 | 559 | 66320-65 | 476 | | |
| 49656B08 | 280 | 49790-09 | 507 | 49850-20 | 547 | 49899-92 | 543 | 49956-01 | 558 | 66320-85 | 476 | | |
| 49656B09 | 280 | 49801-04 | 547 | 49850-21 | 548 | 49899-93 | 543 | 49956-AA | 580 | 66320-99 | 476 | | |
| 49656B10 | 280 | 49801-06 | 547 | 49850-22 | 548 | 49899-94 | 543 | 49957-00 | 558 | 66324-40 | 476 | | |
| 49656B12 | 280 | 49802-04 | 547 | 49850-23 | 548 | 49899-95 | 543 | 49958-00 | 558 | 66324-50 | 476 | | |
| 49656B17 | 280 | 49802-06 | 547 | 49850-24 | 553 | 49899-AA | 580 | 49959-00 | 558 | 66324-65 | 476 | | |
| 49656B26 | 281 | 49803-02 | 547 | 49850-25 | 553 | 49907-01 | 554 | 49960-00 | 559 | 66324-85 | 476 | | |
| 49656C04 | 281 | 49806-00 | 548 | 49850-26 | 553 | 49907-06 | 554 | 49971-25 | 182 | 66324-99 | 476 | | |
| 49656C06 | 281 | 49809-00 | 552 | 49850-27 | 553 | 49907-AA | 554 | 49971M25 | 182 | 66325-30 | 476 | | |
| 49656C07 | 280 | 49811-00 | 147 | 49850-33 | 549 | 49911-19 | 555 | 49971P25 | 182 | 66325-35 | 476 | | |
| 49656C08 | 280 | 49811-01 | 579 | 49850-36 | 550 | 49911-24 | 554 | 49971R00 | 182 | 66325-41 | 476 | | |
| 49656C09 | 280 | 49811-02 | 579 | 49850-37 | 551 | 49911-30 | 555 | 49971R25 | 182 | 66325-46 | 476 | | |
| 49656C10 | 280 | 49812-00 | 147 | 49850-41 | 550 | 49911-35 | 555 | 49972-30 | 182 | 66325-54 | 476 | | |
| 49656C12 | 280 | 49812-01 | 579 | 49850-42 | 551 | 49911-45 | 555 | 49972M30 | 182 | 66325-85 | 476 | | |
| 49656C17 | 280 | 49814-00 | 147 | 49850-43 | 551 | 49916-25 | 554 | 49972P30 | 182 | 66325-99 | 476 | | |
| 49656C26 | 281 | 49814-01 | 579 | 49850-44 | 551 | 49916-35 | 554 | 49972R30 | 182 | 66326-30 | 476 | | |
| 49657-03 | 281 | 49818-00 | 137 | 49850-61 | 549 | 49916-45 | 554 | 49974-25 | 565 | 66326-35 | 476 | | |
| 49657-09 | 282 | 49818-AC | 137 | 49850-63 | 552 | 49916-55 | 554 | 49974-30 | 566 | 66326-40 | 476 | | |
| 49657-10 | 283 | 49818-AD | 137 | 49850-65 | 548 | 49921-00 | 564 | 49974U25 | 565 | 66326-60 | 476 | | |
| 49657-11 | 283 | 49818-AE | 137 | 49850-70 | 551 | 49922-01 | 556 | 49974U30 | 566 | 66326-80 | 476 | | |
| 49657-12 | 282 | 49818-AF | 137 | 49850-71 | 549 | 49922-02 | 556 | 49975-19 | 565 | 66339-02 | 308 | | |
| 49657-30 | 283 | 49820-05 | 136 | 49850-73 | 550 | 49922-03 | 557 | 49975-22 | 565 | 66345-55 | 476 | | |

SALES CONDITIONS

CONDIZIONI DI VENDITA

LIEFERBEDINGUNGEN

CONDITIONS DE VENTE

CONDICIONES DE VENTA

ENG GENERAL TERMS AND CONDITIONS OF SALE

1. APPLICATION OF THE GENERAL CONDITIONS

- 1.1. These General Terms and Conditions of Sale apply to any order/order confirmation/supply made to the Customer.
- 1.2. Placing an order, confirming the order, and receiving the supply implies the acknowledgment and unconditional acceptance of these General Conditions, excluding any other clause or condition which shall be considered null and void. Failure to enforce any provision of these General Conditions shall not constitute a waiver of the Seller's right to enforce such provision in the future.
- 1.3. These General Terms and Conditions of Sale shall enter into force on January 1, 2025, superseding all previous general conditions of the Seller.
- 1.4. The Seller reserves the exclusive right to modify these General Terms and Conditions of Sale at any time, providing written notice to the Customer.

2. OFFER/ORDER/ORDER CONFIRMATION

- 2.1. Acceptance of the offer and/or order confirmation (as outlined therein) constitutes a binding sales contract under these General Terms and Conditions of Sale.
- 2.2. Offers are non-binding.
- 2.3. Quotes are valid for 30 days from the date of issuance unless otherwise stated in the quote.
- 2.4. Prices are exclusive of VAT, customs duties, insurance, and transport costs.
- 2.5. Orders are subject to the Seller's approval. The minimum order amount is €100 net for goods (excluding transport, insurance, and packaging costs).
- 2.6. Standard packaging is free of charge. Any request for special packaging shall be borne by the Customer. For terms, costs, and specific details, refer to the "Service Chart" document available through the Seller's customer service and the customer portal.
- 2.7. Orders must be submitted through the Customer Portal at <https://professional.sambonet.it> or in written form via email, specifying:
The quantity and type of products ordered;
The delivery and billing addresses.
- 2.8. The Customer acknowledges that the offer/order confirmation is considered accepted upon receipt unless otherwise notified within the day of receipt.
- 2.9. Product promotions offered by the Seller are governed by specific terms communicated through appropriate channels and are subject to time limitations, which will not be valid or applicable beyond the stated expiry date.

3. ORDERS FOR CUSTOMIZED PRODUCTS

- 3.1. All items differing from those listed in the catalog are considered "customized."
- 3.2. The Seller can create customized products upon the Customer's request, subject to the following terms:
 - The Seller will provide the Customer with a drawing sheet indicating all necessary parameters (design, positioning, dimensions, etc.) and will proceed with the supply only upon receipt of the signed acceptance.
 - Delivery of a sample, following approval of the drawing sheet, the quote, and payment of a deposit.
 - Production begins upon receipt by the Seller of a 50% deposit of the total order amount.
 - Agreement on the Delivery Date after approval of the final design and/or sample.
 - The Seller may apply a tolerance of +/-10% for products listed in the Sambonet, Paderno, Arthur Krupp, and Rosenthal catalogs/pricelists and +/-2% for those in the Ercuis catalog/pricelist, with quantities rounded up to the highest unit in the shipment of the ordered quantities.
 - The costs of customized order preparation (e.g., labeling, packaging, palletization, or other non-standard requests) shall be borne by the Customer.
 - For Rosenthal-branded products, the minimum order quantity for the first supply with customized designs is 120 pieces per item (minimum reorder quantity is also 120 pieces).
 - Payment of the balance is required before delivery.
- 3.3. Orders for customized products are considered confirmed upon signing the order and/or quote and cannot be canceled.
- 3.4. Customized products cannot be returned for replacement or refund, except for production defects recognized by the Seller's quality control.

4. CUSTOMIZED ORDERS FOR SAMBONET AND TAILOR-MADE PRODUCTS

- 4.1. The following costs are fixed.
- 4.2. Serration of fruit knife blades: Where not included as standard, charged at €0.65 per piece.
- 4.3. Pantograph/Laser Engraving:
 - Setup cost: €70.00;
 - Engraving cost: Cutlery: €0.50 per piece; - Holloware (where possible): €1.00 per piece;
 - Minimum quantities: cutlery 100 pieces per item; - Holloware: 10 pieces per item
- 4.4. Stamping:
 - Cost of stamps: First stamp €300.00; subsequent stamps €150.00 each;
 - Stamping cost: cutlery: €0.50 per piece; Holloware: Quote available upon request;
 - Minimum quantities:
 - New setups: Cutlery: 1,000 pieces per item; - Hollow-handled knives: 800 pieces per item;
 - Reorders: Cutlery: 100 pieces per item - Hollow-handled knives: Non-stampable (only pantograph or laser options available).
- 4.5. Tailor-Made Standard Engravings:
 - Front terminal: A standard logo or monogram (two letters) using standard fonts;
 - Back terminal: The date in standard format, using standard fonts.
 Costs for Tailor-Made Engravings:
 1. €20 for engraving on the front terminal;
 2. €20 for engraving on the back terminal;
 3. €40 for engravings on both terminals.
 Minimum purchase quantities for Tailor-Made loose items:
 1. 6 pieces for alpaca items, in multiples of 6;
 2. 12 pieces for all other items, in multiples of 12.
 Engraving costs per single purchase order:
 - One cost per type of engraving as indicated in points 1, 2, and 3, regardless of the number of pieces up to 150 pieces; for quantities exceeding 150 pieces and multiples of 150, the engraving cost will be applied again.
 - One cost regardless of the number of references—provided the minimum purchase quantities indicated in points 4 and 5 are met.

5. ERCUIS BRAND PRODUCTS: SOLID SILVER, GOLD-PLATED PIECES, PRODUCTS COATED WITH PRECIOUS MATERIALS

- 5.1. The listed selling prices are based on the market quotation of gold and silver as of January 1, 2025, and are provided for reference only.
- 5.2. The Seller reserves the right to update the selling price of the offer based on the market quotations of the aforementioned precious metals.
- 5.3. All offers regarding precious materials will have a limited validity period of 7 days.
- 5.4. Minimum order quantity: the minimum quantity will be communicated during the offer.

6. PAYMENT

- 6.1. The payment of the invoice is due within the payment term previously agreed upon between the parties. The Seller reserves the right to request an advance payment or a deposit for any order.
- 6.2. Any complaints from the Customer cannot in any case delay or suspend the payments.
- 6.3. In the case of delayed payment, the Customer shall be automatically liable to the Seller for a fixed compensation for reminder costs of €40.00. If the reminder costs exceed this amount, the Seller has the right to request an additional compensation. In the event of delayed payment, default interest at the rate specified in Article 5 of Legislative Decree 231/2002 and subsequent amendments, as per Legislative Decree 192/2012, increased by 8%, will be due.
- 6.4. Payments owed to the Seller cannot be suspended nor subject to any discounts or compensation without the written agreement of the Seller.
- 6.5. The defaulting Customer shall return, at their own expense and risk, the unpaid products. If the Customer claims the products, the Seller shall be released from the obligation to return the advance payments received from the Customer, in so far their amount that their amount may offset the recoverable amount for damages and interests due from the Customer (for costs of return or repair).
- 6.6. In case of total or partial non-payment of the invoice, or deterioration of the financial situation of the Customer, the Seller also has the right to:
 - suspend or cancel ongoing orders and deliveries;
 - demand immediate payment of all remaining amounts owed by the Customer under other contracts in progress;

- withhold the products until full payment of the price;
- demand an advance payment for further orders;
- demand payment guarantees.

7. SALES/REEXPORTATION PROHIBITION

- 7.1. The Customer will not sell, export, or re-export, directly and/or indirectly, to the Russian Federation and/or for use in the Russian Federation, nor to Belarus and/or for use in Belarus, any goods supplied under these General Conditions or in relation to them, which fall within the scope of Regulation (EU) No. 833/2014, Article 12 octies of Council Regulation (EU) No. 833/2014 and its amendments, and/or Article 8 octies of Regulation (EC) No. 765/2006 and its amendments, as well as any additional or further regulatory provisions that may be issued in this regard.
- 7.2. The Customer undertakes to do the utmost to ensure that the purpose of paragraph 7.1 is not undermined by third parties downstream in the commercial chain, including any distributors.
- 7.3. Any violation of paragraphs 7.1 and 7.2 shall constitute a serious breach of an essential element of these General Conditions and the contract concluded under them, and the Seller shall have the right to take appropriate remedies, including, by way of example but not limited to: (i) contract termination; and/or (ii) the imposition of a penalty equal to 15% of the total value of the said contract or of the price of the goods exported, if higher; (iii) reporting the violations to the competent authorities. In any case, the Seller reserves the right to claim any greater damages suffered (including, by way of example but not limited to, damages arising from any sanctions imposed on the Seller due to the aforementioned violation).
- 7.4. The Customer must immediately inform the Seller in writing of any issues in the application of paragraphs 7.1 and 7.2, including any relevant activities by third parties that could undermine the purpose of paragraph 7.1. The Customer shall provide the Seller with information regarding compliance with the obligations in paragraphs 7.1 and 7.2 within two (2) weeks from the mere written request for such information.

8. RESERVATION OF OWNERSHIP

- 8.1. All sold products are subject to a reservation of ownership: the goods supplied remain the property of the Seller until full payment of the invoice by the Customer.
- 8.2. The transfer of ownership is subject to the complete payment of the related price by the Customer at the agreed due date, except for the transfer of risks at the date of delivery.
- 8.3. From the delivery of the products, the risks are borne by the Customer, except for the reservation of ownership. The Customer undertakes to insure the products against all risks that they may suffer or cause from their delivery onwards.

9. DELIVERY OF PRODUCTS AND FORCE MAJEURE

- 9.1. Unless otherwise agreed, the Incoterms is FCA Rofengo. The transport is at the expense and risk of the Customer. All expenses and charges of any nature related to transportation are the responsibility of the Customer.
- 9.2. In the case of sales made with EXW and FCA terms, the Customer undertakes to provide the Seller, within 90 days from the date of the sales invoice (Dlgs 87/2024 – Dlgs 471/97), with all necessary proof of the goods' exit from the Italian customs territory and delivery in the foreign destination state. In the event of non-compliance with the above terms, the seller will charge the Italian VAT rate in effect within the 30 days following the 90 days.
- 9.3. Delivery deadlines are indicated as accurately as possible, but depend on the supplier and transport conditions of the Seller. The Seller undertakes to exercise the utmost diligence to meet delivery times.
- 9.4. Exceeding delivery times will not in any case entail the responsibility of the Seller, nor imply the payment of penalties, interest, or could be the subject of claims for damages. In such cases, there is also no provision for the suspension or cancellation of ongoing orders. In any case, delivery within the terms can only be made if the Customer has promptly fulfilled all its obligations towards the Seller.
- 9.5. The Seller will not be held responsible if delayed or failed execution of contractual obligations is due to Force Majeure causes, to the extent that it proves: a) such an obstacle is outside its reasonable control; b) it could not reasonably have been foreseen at the time of the contract's conclusion; c) the effects of the obstacle could not reasonably have been avoided or overcome. In the absence of contrary evidence, events of force majeure are considered, by way of example, war, uprising, trade restrictions, embargo, fire, destruction of equipment, strikes, acts of legal authority, compliance with any law or government order, epidemic, pandemic, natural disaster, or extreme natural event. In such cases, the Seller may suspend its contractual obligations, notifying the other party in writing, and the term for the execution of the supply may be extended for a period equal to the duration of the event. Unless otherwise agreed in writing, if the suspension period expires without result, the contract will be deemed resolved without further notice.
- 9.6. The Seller may also resolve the contract if the performance is objectively too onerous due to an unforeseeable circumstance independent of its will.
- 9.7. Any modification of an order will result in a corresponding modification of the deadlines.
- 9.8. Orders can be delivered in multiple packages and/or multiple deliveries. It is also agreed between the parties that if the Customer does not take possession of the ordered products under the above-accepted conditions, the Seller will invoice the Customer for:
 - storage expenses equivalent to 5% of the order amount, excluding taxes, for each month of delay, with each started month due;
 - any additional transport expenses will be borne by the Customer.

10. DELIVERY TERMS OF PRODUCTS UNDER SAMBONET/PADERNO/ARTHUR KRUPP/ROSENTHAL BRANDS

Goods listed in the Sambonet/Paderno/Arthur Krupp/Rosenthal catalogs are delivered at client place by courier contracted with the Seller under the conditions indicated in the following table. For all other catalogs/brands, the condition specified in point 9.1 applies instead.

| GROUP | COUNTRIES | DELIVERED AT PLACE (DAP) NET MERCHANDISE VALUE | Order handling fees for orders under Delivered At Place (DAP) value.** |
|-------|---|--|--|
| A | Italy, Germany, Austria, France, Netherlands, Belgium, Luxembourg | 500€ | 20€ |
| B | Spain, Portugal, Poland, Czech Republic, Slovakia, Hungary, Romania, Slovenia, Croatia, Bulgaria, Norway, Andorra, UK, Northern Ireland, Sweden | 800€ | 35€ |
| C | Greece, Ireland, Latvia, Lithuania, Estonia, Denmark, Finland | 1.200€ | 60€ |

** Order handling fees are to be considered per individual order transmitted by the customer and will be charged cumulatively on the invoice.

11. RETURNS/CLAIMS

- 11.1. The goods must be inspected upon receipt.
- 11.2. In the event of defective/damaged packages, the Customer agrees to:
 - make clear and precise reservations on the delivery receipt in case of loss or damage observed on the products;
 - inspect and record such reservations in the presence of the carrier;
 - clearly indicate the nature of the products and the number of missing or defective pieces
 - confirm the reservations to the Seller in writing within 48 hours via email.
 In the absence of this, the Customer will lose the right to claim against the Seller for any loss or damage resulting from the transport. Reservations such as "subject to unpacking" or "subject to further inspection" are not permitted and hold no value.

- 11.3. Claims will be accepted within 15 days from the invoice date, which is a non-negotiable deadline, under the following conditions:
- The claim/request for return must be made through the guided procedure at www.professional.sambonet.it in the user area;
 - The goods must be returned free to our factory;
 - If the customer is responsible, the Seller will charge a 15% of the net price, with a minimum of €25,00 for handling costs;
 - In the case of the Seller's responsibility, the goods will be replaced and returned free to the customer;
 - For products returned for repair outside the warranty, shipping and return costs are the responsibility of the customer;
 - Returns will be subject to a quantitative and qualitative check, and any missing or damaged items will remain the responsibility of the Customer;
 - Returns for special items (not in catalog), Tailor Made engraved items, other customizations, or items no longer in production will not be accepted.
- 11.4. The product can only be returned with proof of purchase from the Seller. The products must be returned in their original packaging within 8 days from the Seller's written agreement.

12. WARRANTIES – LIMITS OF LIABILITY – PRODUCT SAFETY

- 12.1. The Seller is insured according to its status as a manufacturer of products. The Seller's liability is limited to the replacement of goods recognized as defective, provided they have not been altered, excluding any other indemnity.
- 12.2. The Seller does not provide any warranty against the consequences of any inadequacy in storage conditions.
- 12.3. The Seller does not warrant damages arising from improper use or use in inappropriate conditions not corresponding to the instructions for use. The Seller shall not be liable in any case to the Customers, their agents, employees, successors, or assigns for any indirect or immaterial damages of any kind, including, but not limited to, losses, costs, damages, lost income or profits, suffered by the Customer or any third party under its contractual obligations.
- 12.4. The total and cumulative liability of the Seller under the Contract execution shall in no case exceed ten percent (10%) of the order amount. The photographs of the products in the catalog have no contractual value.
- 12.5. The measurements, characteristics, and illustrations of the products are indicative and subject to variations without notice if technical production requirements necessitate. Given that production is artisanal, slight differences may arise between batches of the same product.
- 12.6. The goods are intended for sale in the country where the Customer is based. If the goods are sold in a different country, it shall be the Customer's responsibility to verify applicable regulations in that country, including import regulations, as well as the risk of claims from third parties for any reason. It is understood that the Seller will be indemnified and held harmless by the Customer for anything caused by the sale of the goods in such a different country.
- 12.7. In accordance with Regulation (EU) 2023/988 on general product safety, the Customer may contact the Seller at the following email address product.safety@sambonet.it and obtain any further information for products concerned by the aforementioned regulation via specific QR codes:

PADERNO BRAND PRODUCTS



SAMBONET BRAND PRODUCTS



13. INTELLECTUAL PROPERTY

- 13.1. The Seller retains exclusive ownership of trademarks, designs, drafts, models, and more generally, all documents of any nature issued or sent by the Seller to the Customer.
- 13.2. The sale of the products does not entail any transfer of intellectual property to the Customer. Intellectual property rights, whether registered or not, remain fully and entirely with the Seller. The Seller reserves the right to take legal action in the event of a violation of the provisions of this chapter.
- 13.3. It is therefore expressly prohibited to reproduce, imitate these trademarks and/or any other similar distinctive sign as a trademark, domain name, or for any other use. Similarly, the products, designs, drafts, models cannot be executed, reproduced, or represented without the prior written consent of the Seller, nor be the subject of any claim of any intellectual property right of any nature.
- 13.4. Any advertising document relating to the products and the brand may only be used by the Customer subject to prior express written agreement. The Seller cannot in any case be held responsible for the origin of products copied and sold under its brand, especially on the internet, which are a violation of its industrial and intellectual property rights by third parties.
- 13.5. The Customer expressly authorizes the Seller to indicate that it is acting on behalf of the customer and/or that the customer uses the products of the Seller and to cite its name as a reference in commercial documents, on its website, and on any other communication support, existing or to come.
- 13.6. The nature of the services performed for the Customer and the type of product of the Seller used by the Customer do not constitute confidential information.

14. PERSONAL DATA

- 14.1. The sale of products by the Seller requires the collection of certain personal information about the Customer, necessary for the proper administration of orders and compliance with the Seller's contractual obligations.
- 14.2. The personal data provided by the Customer will be processed in accordance with EU Regulation No. 2016/679 and Legislative Decree No. 196/2003. These data are subject to computer processing and are stored securely, according to the current state of the art, in accordance with GDPR provisions. The data controller is the Seller (contact information follows). Data is retained for a reasonable period necessary for the proper administration of orders. The personal data collected is not subject to any transfer abroad and may nonetheless be the subject of a transfer to a transferee company and/or purchaser within the framework of a restructuring.
- 14.3. The Customer has the right to access, modify, rectify, and delete data concerning them, which they can exercise with the Seller via email privacy@sambonet.it or by ordinary mail.

15. CONFIDENTIALITY

- 15.1. The Customer will treat as strictly confidential and agrees not to disclose any information of which they may become aware during the execution of the Contract or an order. This clause remains in effect as long as the confidential information is not made public by the Seller.

16. APPLICABLE LAW – DISPUTE RESOLUTION

- 16.1. For any dispute or controversy, Italian law applies, and the Novara Court has exclusive jurisdiction.
- 16.2. For foreign customers, Italian law applies not only to disputes but to the entire contractual relationship, excluding the application of the Vienna Convention concerning the sale of movable goods.

ITA CONDIZIONI GENERALI DI VENDITA

1. APPLICAZIONE DELLE CONDIZIONI GENERALI

- 1.1. Le presenti Condizioni Generali di vendita sono applicabili a qualsiasi ordine/conferma d'ordine/fornitura effettuata al Cliente.
- 1.2. La trasmissione di un ordine, la conferma dell'ordine e la fornitura comportano la presa visione e l'accettazione, senza riserve, delle presenti Condizioni Generali, con esclusione di qualsiasi altra clausola o condizione che sarà da considerarsi come non apposta. La mancata applicazione di una disposizione delle presenti Condizioni Generali non costituisce rinuncia all'eventuale applicazione futura di tale disposizione da parte del Venditore.
- 1.3. Le presenti Condizioni Generali di Vendita entrano in vigore il 1° gennaio 2025, annullando e sostituendo tutte le precedenti condizioni generali del Venditore.
- 1.4. Il Venditore si riserva il diritto insindacabile di modificare in qualunque momento le presenti Condizioni Generali di vendita, dandone comunicazione per iscritto al Cliente.

2. OFFERTA/ORDINE/CONFERMA D'ORDINE

- 2.1. Con l'accettazione dell'offerta e/o della conferma d'ordine (con le modalità ivi contenute), si genera a tutti gli effetti un contratto di compravendita conforme alle presenti Condizioni Generali di Vendita.
- 2.2. Le offerte sono libere e non vincolanti all'ordine.

- 2.3. I preventivi sono validi per 30 giorni, a partire dalla loro data di emissione, salvo diverse indicazioni contenute negli stessi.
- 2.4. I prezzi si intendono al netto d'IVA, ed escluse spese doganali, spese assicurative e spese di trasporto.
- 2.5. Gli ordini sono soggetti ad approvazione del Venditore. L'importo minimo dell'ordine è di 100 euro netto merce (escluse spese di trasporto, assicurazione e imballo).
- 2.6. L'imballo standard è gratuito. Eventuali richieste di imballaggi speciali saranno a carico del Cliente. Per condizioni, costi e dettagli specifici, fare riferimento al documento denominato "Carta dei servizi" disponibile presso il servizio clienti del Venditore e sul portale clienti.
- 2.7. Il Cliente dovrà inviare l'ordine, tramite il Portale Clienti all'indirizzo <https://professional.sambonet.it> o in forma scritta via e-mail, precisando quanto segue: la quantità e il tipo di prodotti ordinati; il luogo di consegna e di fatturazione.
- 2.8. Il Cliente prende atto che l'offerta/conferma d'ordine si intende accettata al momento della ricezione, salvo eventuali segnalazioni entro il giorno di ricevimento della stessa.
- 2.9. Le promozioni di prodotti messe in atto dal Venditore, sono regolate da specifiche condizioni, comunicate al cliente tramite appositi canali, e sono soggette a limitazioni temporali che non saranno valevoli o applicabili oltre la data di validità delle stesse.

3. ORDINI DI PRODOTTI PERSONALIZZATI

- 3.1. Tutti gli articoli che differiscono da quanto a listino/catalogo sono da intendersi "personalizzati".
- 3.2. Il Venditore è in grado di realizzare prodotti personalizzati su richiesta del cliente, previo studio del proprio Centro Stile, alle seguenti condizioni:
- Il Venditore provvederà a fornire al Cliente una scheda drawing con l'indicazione di tutti i parametri necessari (disegno, posizione, dimensioni, ecc.) e procederà alla fornitura solo al ricevimento della stessa firmata per accettazione;
 - eventuale invio di un campione, dopo approvazione della relativa scheda, del preventivo e del versamento dell'acconto;
 - messa in produzione a partire dal ricevimento da parte del Venditore dell'acconto pari al 50% dell'importo complessivo dell'ordine;
 - accordo sulla Data di Consegna dopo l'approvazione del disegno esecutivo e/o campione;
 - facoltà per il Venditore di applicare, per ogni singolo articolo, una tolleranza pari al +/-10% per i prodotti presenti nei cataloghi/listini Sambonet, Paderno, Arthur Krupp e Rosenthal e del +/-2% per i prodotti presenti nel catalogo/listino Ercuis, con arrotondamento all'unità superiore, nella spedizione dei quantitativi ordinati;
 - I costi di preparazione personalizzata dell'ordine (quali etichettatura, confezionamento, imballaggio, pallettizzazione e/o ogni altra richiesta fuori dallo standard) saranno a carico del Cliente;
 - per i prodotti a marchio Rosenthal la quantità minima d'ordine per la prima fornitura con modelli o disegni personalizzati è di 120 pezzi per articolo (per eventuale riordino quantità minima è di 120 pezzi);
 - pagamento del saldo ordine prima della consegna.
- 3.3. Gli ordini di prodotti personalizzati sono ritenuti confermati a partire dalla firma dell'ordine e/o del preventivo e non possono essere annullati.
- 3.4. I prodotti personalizzati non possono essere restituiti per sostituzione o rimborso, salvo per difetto di produzione riconosciuto dal controllo qualità del Venditore.

4. ORDINI DI PRODOTTI PERSONALIZZATI A MARCHIO SAMBONET E TAILOR MADE

- 4.1. I costi sottoindicati sono da intendersi fissi.
- 4.2. Seghettatura lame coltelli frutta: ove non prevista di serie, con addebito di € 0,65 al pezzo.
- 4.3. Incisione al Pantografo/Laser:
- costo impianto: € 70,00;
 - costo incisione: posateria € 0,50 al pezzo - vasellame, incisione ove possibile, € 1,00 al pezzo;
 - quantità minime: posateria 100 pezzi per articolo - vasellame 10 pezzi per articolo.
- 4.4. Punzonatura:
- costo punzoni: il primo punzone € 300,00 - i successivi € 150,00 cad.;
 - costo punzonatura: posateria € 0,50 al pezzo - vasellame preventivo su richiesta;
 - quantità minime:
 - nuovi impianti: posateria 1.000 pezzi per articolo - coltelli manico cavo 800 pezzi per articolo;
 - riordini: posateria 100 pezzi per articolo - coltelli a manico cavo NON punzonabili (solo pantografo o laser).
- 4.5. Tipologia di incisioni Tailor Made standard:
- sul terminale frontale: uno dei loghi standard, oppure il monogramma (due lettere) utilizzando uno dei caratteri standard;
 - Sul terminale posteriore: la data in formato standard, utilizzando uno dei caratteri standard.
- Costo di incisione Tailor Made:
- € 20 per incisioni sul terminale frontale;
 - € 20 per incisioni sul terminale posteriore;
 - € 40 per incisioni sul terminale frontale e sul terminale posteriore.
- Ordine minimo di acquisto per articoli sfusi Tailor Made:
- 6 pz per le referenze realizzate in alpaca, a multipli di 6 pz;
 - 12 pz per tutte le altre referenze, a multipli di 12 pz;
- Applicazione del costo di incisione Tailor Made sul singolo ordine di acquisto:
- Un solo costo per ogni tipologia di incisione indicata ai punti 1,2,3 a prescindere dal numero di pz fino a 150 pz, oltre i 150 pz e a multipli di 150 pz verrà nuovamente applicato il costo di incisione;
 - Un solo costo a prescindere dal numero di referenze - se superiori al minimo di acquisto indicato al punto 4 e 5.

5. PRODOTTI MARCHIO ERCUIS:

ARGENTO MASSICIO, PEZZI DORATI E COLLEZIONI CON MATERIALI PREZIOSI

- 5.1. I prezzi di vendita indicati a listino si basano sulla quotazione dell'oro e dell'argento alla data del 01/01/2025 e sono forniti esclusivamente a titolo informativo.
- 5.2. Il Venditore si riserva quindi la facoltà di aggiornare il prezzo di vendita dell'offerta in base all'andamento delle quotazioni di mercato dei suddetti metalli preziosi.
- 5.3. Tutte le offerte inerenti i materiali preziosi avranno validità temporale limitata a 7 giorni.
- 5.4. Minimo d'ordine: la quantità minima verrà comunicata in sede di offerta.

6. PAGAMENTO

- 6.1. Il pagamento della fattura è dovuto entro il termine di pagamento preventivamente concordato tra le parti. Il Venditore si riserva il diritto di richiedere un pagamento anticipato o un acconto per qualsiasi ordine.
- 6.2. Eventuali reclami del Cliente non potranno in alcun caso avere come effetto il differimento o la sospensione dei pagamenti.
- 6.3. Il Cliente in situazioni di ritardo di pagamento sarà peraltro debitore di diritto, nei confronti del Venditore di un indennizzo forfetario per spese di sollecito pari a € 40,00. Qualora le spese di sollecito siano superiori al suddetto importo, il Venditore avrà il diritto di richiedere un ulteriore indennizzo. In caso di ritardato pagamento, saranno dovuti gli interessi di mora al saggio di cui all'art.5 D.LGS. 231/2002 e succ. modifiche come da D.LGS. 192/2012, maggiorato dell'8%.
- 6.4. I pagamenti che sono dovuti al Venditore non possono essere sospesi, né essere oggetto di un qualsiasi sconto o compenso senza l'accordo scritto del Venditore.
- 6.5. Il Cliente inadempiente dovrà restituire, a sue spese e a suo rischio, i prodotti non pagati. Qualora dovesse rivendicare i prodotti, il Venditore sarà dispensato dall'obbligo di restituire gli account ricevuti al Cliente, nella misura in cui il loro importo potrà compensarsi con l'importo esigibile dei risarcimenti danni e interessi dovuti dal Cliente (per spese di restituzione o riparazione).
- 6.6. In caso di mancato pagamento totale o parziale della fattura, o di degrado della situazione finanziaria del Cliente, il Venditore avrà anche la facoltà di:
- sospendere o annullare gli ordini e le consegne in corso;
 - esigere di diritto il pagamento immediato della totalità degli importi restanti dovuti dal Cliente, relativi ad altri contratti in corso;
 - trattenerne i prodotti fino al completo pagamento del prezzo;
 - esigere un pagamento anticipato per gli ulteriori ordini;
 - esigere garanzie di pagamento.

7. DIVIETO DI VENDITA/RIESPORTAZIONE

- 7.1. Il Cliente non venderà, esporterà o riesporterà, direttamente e/o indirettamente, nella Federazione Russa e/o per uso nella Federazione Russa né in Bielorussia e/o per uso in Bielorussia alcuna merce, fornita ai sensi delle presenti Condizioni Generali o in relazione ad esse, che rientri nell'ambito di applicazione del regolamento (UE) n. 833/2014, dell'articolo 12 octies del regolamento (UE) n. 833/2014 del Consiglio e s.m.i. e/o dell'articolo 8 octies del regolamento (CE) n. 765/2006 e s.m.i., nonché di eventuali diverse e/o ulteriori disposizioni normative che dovessero essere emanate al riguardo.
- 7.2. Il Cliente si impegna a fare il massimo per garantire che lo scopo del paragrafo 7.1 non sia vanificato da terzi a valle della catena commerciale, compresi eventuali rivenditori.
- 7.3. Qualsiasi violazione dei paragrafi 7.1 e 7.2 costituirà una violazione grave di un elemento essenziale delle presenti Condizioni Generali e del contratto concluso ai sensi delle stesse, e il Venditore avrà il diritto di adottare i rimedi appropriati, tra cui, a titolo esemplificativo e non esaustivo: (i) la risoluzione del contratto; e/o (ii) l'applicazione di una penale pari al 15% del valore totale del suddetto contratto o del prezzo delle merci esportate, se superiore; (iii) segnalazione delle violazioni alle autorità competenti. In ogni caso è fatto salvo il maggior danno subito dal Venditore (incluso, a titolo esemplificativo e non esaustivo, quello derivante da eventuali sanzioni comminate al Venditore a causa della violazione sopra citata).
- 7.4. Il Cliente deve informare immediatamente per iscritto il Venditore di eventuali problemi all'applicazione dei paragrafi 7.1 e 7.2, comprese eventuali attività pertinenti da parte di terzi che potrebbero vanificare lo scopo del paragrafo 7.1. Il Cliente dovrà mettere a disposizione del Venditore le informazioni relative al rispetto degli obblighi di cui ai paragrafi 7.1 e 7.2 entro due (2) settimane dalla mera richiesta scritta di tali informazioni.

8. RISERVA DI PROPRIETÀ

- 8.1. Tutti i prodotti venduti sono soggetti a riserva di proprietà: la merce fornita rimane di proprietà del Venditore fino all'integrale pagamento della fattura da parte del Cliente.
- 8.2. Il trasferimento di proprietà è subordinato al completo pagamento del relativo prezzo da parte del Cliente alla scadenza pattuita, fatto salvo il trasferimento dei rischi alla data di consegna.
- 8.3. A partire dalla consegna dei prodotti i rischi sono a carico del Cliente, fatta salva la riserva di proprietà. Il Cliente si impegna ad assicurare i prodotti contro tutti i rischi che possono subire o cagionare a partire dalla loro consegna.

9. CONSEGNA DEI PRODOTTI E FORZA MAGGIORE

- 9.1. Salvo quanto diversamente convenuto, l'Incoterms è FCA Orfengo. Il trasporto è effettuato a spese e rischio del Cliente. Tutte le spese e tutti gli oneri di qualsivoglia natura relativi al trasporto sono a carico del Cliente.
- 9.2. In caso di vendita effettuata con rese EXW e FCA, il Cliente si impegna a fornire al Venditore, entro il termine di 90 giorni dalla data della fattura di vendita (Dlgs 87/2024 - Dlgs 471/97) tutte le necessarie prove di avvenuta uscita della merce dal territorio doganale italiano e avvenuta consegna nello stato estero di destinazione. In caso di mancato rispetto dei termini sopra descritti il venditore provvederà ad addebitare, nei 30 giorni successivi al 90, l'IVA all'aliquota italiana in vigore.
- 9.3. Le scadenze di consegna sono indicate il più esattamente possibile, ma dipendono dalle condizioni di approvvigionamento e trasporto del Venditore. Il Venditore si impegna a porre la massima diligenza ai fini del rispetto delle consegne.
- 9.4. Il superamento dei tempi di consegna non comporterà in alcun caso la responsabilità del Venditore, né implicherà il versamento di penalità, interessi o potrà essere oggetto di richieste per risarcimento danni. In tali casi non è, inoltre, prevista la sospensione o l'annullamento degli ordini in corso. In ogni caso, la consegna entro i termini potrà essere effettuata soltanto se il Cliente avrà puntualmente ottemperato a tutti i suoi obblighi nei confronti del Venditore.
- 9.5. Il Venditore non sarà ritenuto responsabile qualora la ritardata o mancata esecuzione delle obbligazioni contrattuali dipenda da cause di Forza Maggiore, nella misura in cui dimostra: a) che tale impedimento è al di fuori del suo ragionevole controllo; b) che non poteva ragionevolmente essere previsto al momento della conclusione del contratto; c) che gli effetti dell'impedimento non avrebbero potuto ragionevolmente essere evitati o superati. In assenza di prove contrarie, si considerano eventi di forza maggiore, a titolo esemplificativo, guerra, rivolta, restrizioni commerciali, embargo, incendio, distruzione di attrezzature, scioperi, atto di autorità legale, rispetto di qualsiasi legge o ordine governativo, epidemia, pandemia, calamità naturale o evento naturale estremo. In tali casi, il Venditore potrà sospendere l'adempimento dei suoi obblighi contrattuali, dandone avviso per iscritto all'altra parte ed il termine per l'esecuzione della fornitura potrà essere prorogato per un periodo uguale alla durata dell'evento. Salvo diverso accordo scritto, decorso inutilmente il periodo di sospensione, il contratto si intenderà risolto senza ulteriore avviso.
- 9.6. Il Venditore potrà, altresì, risolvere il contratto qualora l'esecuzione della prestazione sia resa oggettivamente troppo onerosa da una circostanza imprevedibile indipendente dalla sua volontà.
- 9.7. Qualsiasi modifica di ordine darà luogo a una conseguente modifica delle scadenze.
- 9.8. Gli ordini possono essere consegnati in più imballi e/o più consegne. Viene peraltro convenuto tra le parti che se il Cliente non prende possesso dei prodotti ordinati alle condizioni accettate qui sopra, il Venditore fatturerà al Cliente:
- spese di custodia equivalenti al 5% dell'importo dell'ordine, tasse escluse, per mese di ritardo, essendo ogni mese già iniziato dovuto;
 - qualsiasi ulteriore spesa di trasporto sarà a carico del Cliente.

10. CONDIZIONI DI RESA PRODOTTI A MARCHIO SAMBONET/PADERNO/ARTHUR KRUPP/ROSENTHAL

La merce presente nei cataloghi Sambonet/Paderno/Arthur Krupp/Rosenthal è resa franco domicilio Cliente tramite corriere convenzionato con il Venditore alle condizioni indicate nella tabella che segue. Per tutti gli altri cataloghi/marchi è invece applicabile la condizione presente al punto 9.1.

| GRUPPO | PAESI | PORTO FRANCO VALORE NETTO MERCE | Spese di gestione ordine, per ordini inferiori al Porto Franco ** |
|--------|--|---------------------------------|---|
| A | Italia, Germania, Austria, Francia, Olanda, Belgio, Lussemburgo | 500€ | 20€ |
| B | Spagna, Portogallo, Polonia, Rep Ceca, Slovacchia, Ungheria, Romania, Slovenia, Croazia, Bulgaria, Norvegia, Andorra, UK, Irlanda del nord, Svezia | 800€ | 35€ |
| C | Grecia, Irlanda, Lettonia, Lituania, Estonia, Danimarca, Finlandia | 1.200€ | 60€ |

** Le spese di gestione ordine sono da intendersi per singolo ordine trasmesso dal cliente e verranno addebitate in fattura in maniera cumulativa.

11. RESI/RECLAMI

- 11.1. La merce deve essere controllata al ricevimento.
- 11.2. In caso di colli difettosi/danneggiati, il Cliente si impegna:
- ad emettere riserve chiare e precise sulla ricevuta di consegna in caso di perdita o avaria constatata sui prodotti;
 - a constatare e scrivere tali riserve in presenza dello spedizioniere;
 - indicare chiaramente la natura dei prodotti e il numero di pezzi mancanti o difettosi.
 - a confermare entro 48 ore le proprie riserve al Venditore in forma scritta, mediante e-mail.
- In mancanza di questo, il Cliente perderà il diritto di procedere a qualsiasi ricorso contro il Venditore in caso di perdita o avaria risultanti dal trasporto. Le formule «con riserva di disimballaggio» o «con riserva di ulteriore verifica» non sono ammesse e non hanno alcun valore.

- 11.3. I reclami saranno accettati entro 15 giorni dalla data fattura, termine ultimo non negoziabile, alle seguenti condizioni:
- la segnalazione di reclamo / richiesta di reso merce deve essere fatta attraverso la procedura guidata all'indirizzo www.professionalsambonet.it nell'area utente;
 - la merce dovrà essere resa franco nostra fabbrica;
 - in caso di responsabilità del cliente, il Venditore provvederà all'addebito del 15% del prezzo netto, con un minimo di € 25,00, per costi di gestione;
 - in caso di accertata responsabilità del Venditore, la merce verrà sostituita e resa franco domicilio cliente;
 - per prodotti resi per riparazione non in garanzia, le spese di spedizione e rispedizione, sono a carico del cliente;
 - i resi saranno soggetti a un controllo quantitativo e qualitativo, e gli eventuali articoli mancanti o deteriorati rimarranno a carico del Cliente;
 - non saranno accettati resi per articoli speciali (non a catalogo), incisi Tailor Made, con altre personalizzazioni o fuori produzione.
- 11.4. Il prodotto potrà essere restituito solo dietro prova dell'acquisto presso il Venditore. I prodotti dovranno essere restituiti nel loro imballaggio originario entro 8 giorni a partire dall'accordo scritto del Venditore.

12. GARANZIE - LIMITI DI RESPONSABILITÀ - SICUREZZA PRODOTTI

- 12.1. Il Venditore è assicurato conformemente alla sua qualità di fabbricante di prodotti. La responsabilità del Venditore è limitata alla sostituzione della merce riconosciuta difettosa, a condizione che non abbia subito modifiche, esclusa qualsiasi altra indennità.
- 12.2. Il Venditore non fornisce alcuna garanzia contro le conseguenze dell'eventuale inadeguatezza delle condizioni di stoccaggio.
- 12.3. Il Venditore non garantisce i danni derivanti da un uso inappropriato o in condizioni inappropriate o non corrispondenti alle istruzioni per l'uso. Il Venditore non sarà in alcun caso responsabile verso i Clienti, i suoi agenti, dipendenti, successori o aventi causa, di un qualsiasi danno indiretto o immateriale di qualsivoglia natura, ivi compresi, e senza limite, le perdite, i costi, i danni, le perdite di reddito o di profitto, subiti dal Cliente o da un qualsiasi terzo nell'ambito dei suoi obblighi contrattuali.
- 12.4. La responsabilità totale e cumulata del Venditore nell'ambito dell'esecuzione del Contratto non potrà in alcun caso eccedere il dieci per cento (10%) dell'importo dell'ordine. Le fotografie dei prodotti del catalogo non hanno valore contrattuale.
- 12.5. Le misure, caratteristiche ed illustrazioni dei prodotti sono indicative e soggette a variazioni senza preavviso qualora esigenze tecnico produttive lo richiedessero. In considerazione del fatto che la produzione è artigianale, potrebbero rivelarsi lievi differenze tra partite diverse dello stesso prodotto.
- 12.6. La merce è destinata alla commercializzazione nel Paese in cui ha sede il Cliente. Qualora la merce sia commercializzata in un Paese differente, sarà onere del cliente verificare le normative applicabili in tale Paese incluse le normative di importazione, nonché il rischio di contestazioni da parte di terzi a qualunque titolo, restando inteso che il Venditore sarà manlevato e tenuto indenne dal cliente per quanto causato dalla vendita della merce in tale diverso Paese.
- 12.7. In conformità al Regolamento (UE) 2023/988 relativo alla sicurezza generale dei prodotti, il Cliente potrà contattare il Venditore al seguente indirizzo e-mail sicurezza.prodotto@sambonet.it e reperire qualsiasi ulteriore informazione per i prodotti interessati dal citato regolamento tramite appositi QR Code:

PRODOTTI MARCHIO PADERNO



PRODOTTI MARCHIO SAMBONET



13. PROPRIETÀ INTELLETTUALE

- 13.1. Il Venditore detiene la proprietà esclusiva dei marchi, dei disegni, delle bozze, dei piani modello e in linea più generale di tutti i documenti di qualsivoglia natura rilasciati o inviati dal Venditore al Cliente.
- 13.2. La vendita dei prodotti non comporta alcun trasferimento di proprietà intellettuale a favore del Cliente. I diritti di proprietà intellettuale, depositati o meno, rimangono di proprietà piena e intera del Venditore. Il Venditore si riserva il diritto di agire in giudizio in caso di violazione delle disposizioni di cui al presente capitolo.
- 13.3. È pertanto espressamente vietato effettuare qualsiasi riproduzione, imitazione di questi marchi e/o qualsiasi altro segno distintivo identico o simile, a titolo di marchio, nome di dominio o per qualsiasi altro uso. Analogamente, i prodotti, i disegni, le bozze, i piani non possono essere né eseguiti né riprodotti, né rappresentati senza la previa autorizzazione scritta del Venditore, e neppure essere oggetto di alcuna rivendicazione di qualsiasi diritto di proprietà intellettuale di qualsivoglia natura.
- 13.4. Qualsiasi documento pubblicitario, relativo ai prodotti e al marchio, potrà essere utilizzato dal cliente soltanto previo accordo espresso e scritto. Il Venditore non potrà in nessun caso essere ritenuto responsabile dell'origine dei prodotti copiati e venduti con il suo marchio, in particolare su Internet, che risultano essere una violazione dei suoi diritti di proprietà industriale e intellettuale da parte di terzi.
- 13.5. Il Cliente autorizza espressamente il Venditore a indicare che interviene per conto del cliente e/o che il cliente utilizza i prodotti del Venditore e a citarne il nome come referenza nei documenti commerciali, sul suo sito internet e su qualsiasi altro supporto di comunicazione esistente o a venire.
- 13.6. La natura dei servizi realizzati per il Cliente e il tipo di prodotto del Venditore utilizzato dal Cliente non costituiscono informazioni confidenziali.

14. DATI PERSONALI

- 14.1. La vendita di prodotti da parte del Venditore richiede la raccolta di un certo numero di informazioni personali relative al Cliente, necessarie alla corretta amministrazione degli ordini e al rispetto degli obblighi contrattuali del Venditore.
- 14.2. I dati personali forniti dal Cliente saranno oggetto di trattamento nel rispetto del Regolamento UE n. 2016/679 e del D. Lgs n. 196/2003. Tali dati sono oggetto di un'elaborazione informatica e sono custoditi in condizioni sicure, secondo gli attuali mezzi della tecnica, nel rispetto delle disposizioni della GDPR. Il responsabile del trattamento è il Venditore (informazioni di contatto a seguire). I dati sono conservati per un periodo ragionevole necessario alla corretta amministrazione degli ordini. I dati personali raccolti non sono oggetto di alcun trasferimento all'estero e potranno comunque essere oggetto di una cessione a favore di un cessionario d'azienda e/o acquirente nell'ambito di una ristrutturazione.
- 14.3. Il Cliente dispone di un diritto di accesso, modifica, rettifica, cancellazione dei dati che lo riguardano, che può esercitare presso il Venditore tramite e-mail privacy@sambonet.it o mediante posta ordinaria.

15. RISERVATEZZA

- 15.1. Il Cliente considererà rigorosamente confidenziale e si impegna a non divulgare qualsiasi informazione di cui potrà venire a conoscenza in occasione dell'esecuzione del Contratto o di un ordine. Questa clausola rimarrà valida fintantoché le informazioni confidenziali non saranno rese di pubblico dominio ad opera del Venditore.

16. DIRITTO APPLICABILE - SOLUZIONE DELLE CONTROVERSIE

- 16.1. Per ogni contestazione o controversia è applicabile la legge Italiana ed è esclusivamente competente il Foro di Novara.
- 16.2. In caso di clienti esteri, la legge italiana si applica non solo alle controversie, ma all'intero rapporto contrattuale, escludendo l'applicazione della Convenzione di Vienna relativa alla vendita di beni mobili.

DEU ALLGEMEINE VERKAUFSBEDINGUNGEN

1. ANWENDUNG DER ALLGEMEINEN GESCHÄFTSBEDINGUNGEN (AGB)

- 1.1. Diese Allgemeinen Verkaufsbedingungen gelten für alle übermittelten Bestellungen/ Auftragsbestätigungen/erfolgte Lieferungen an den Kunden.
- 1.2. Die Übermittlung einer Bestellung, die Auftragsbestätigung und die Lieferung gelten als ausnahmslose Anerkennung und Annahme der vorliegenden AGB unter Ausschluss jeder anderen Klausel oder Bedingung, die als nicht gegeben angesehen wird. Die Nichtanwendung einer Bestimmung dieser AGB stellt keinen Verzicht auf die künftige Anwendung der betreffenden Bestimmung durch den Verkäufer dar.
- 1.3. Die vorliegenden Allgemeinen Verkaufsbedingungen treten am 1. Januar 2025 in Kraft. Sie machen

- alle vorherigen AGB des Verkäufers ungültig und ersetzen sie.
14. Der Verkäufer behält sich das unanfechtbare Recht vor, diese Allgemeinen Verkaufsbedingungen jederzeit durch schriftliche Mitteilung an den Kunden zu ändern.

2. ANGEBOT/BESTELLUNG/AUFTRAGSBESTÄTIGUNG

- 2.1. Mit der schriftlichen Annahme des Angebots und/oder der Auftragsbestätigung (mit allen enthaltenen Bedingungen) kommt mit voller Rechtswirksamkeit ein Kaufvertrag gemäß diesen allgemeinen Verkaufsbedingungen zustande.
- 2.2. Die Angebote sind freibleibend.
- 2.3. Die Angebote gelten 30 Tage ab dem Datum ihrer Übermittlung, sofern nicht anders angegeben.
- 2.4. Die Preise verstehen sich abzüglich MwSt., und ohne Zollgebühren, Versicherungs- und Versandkosten.
- 2.5. Die Bestellungen unterliegen der Genehmigung durch den Verkäufer.
Der Mindestwarenbestellwert liegt bei 100 Euro netto (ohne Versand-, Versicherungs- und Verpackungskosten).
- 2.6. Die Standardverpackung ist kostenlos. Spezialverpackungen können vom Kunden beantragt werden und gehen auf seine Kosten. Die Bedingungen, Kosten und spezifischen Einzelheiten sind dem Dokument „Service Charter“ zu entnehmen, das beim Kundenservice des Verkäufers und auf dem Kundenportal zur Verfügung steht.
- 2.7. Der Kunde muss die Bestellung über das Kundenportal an <https://professional.sambonet.it> oder schriftlich per E-Mail unter Nennung folgender Angaben übermitteln: die Menge und die Art der bestellten Artikel; die Lieferanschrift und Rechnungsanschrift.
- 2.8. Der Kunde erkennt an, dass das Angebot bzw. die Auftragsbestätigung zum Zeitpunkt des Eingangs als angenommen gilt, vorbehaltlich einer etwaigen Mitteilung innerhalb des Tages des Eingangs.
- 2.9. Die vom Verkäufer durchgeführten Werbeaktionen für Produkte unterliegen besonderen Bedingungen, die dem Kunden auf geeignetem Wege mitgeteilt werden und sind zeitlich begrenzt, so dass sie nach Ablauf ihrer Gültigkeit nicht mehr anwendbar sind.

3. BESTELLUNGEN VON KUNDENINDIVIDUELLEN ARTIKELN

- 3.1. Alle Artikel, die sich von denen der Preisliste/des Katalogs unterscheiden, gelten als „kundenindividuell“.
- 3.2. Der Verkäufer kann auf Anfrage des Kunden und nach vorheriger Prüfung vonseiten seines Style Centre unter folgenden Bedingungen kundenindividuelle Artikel fertigen:
- Der Verkäufer legt dem Kunden ein Beschreibungsblatt mit allen erforderlichen Parametern (Zeichnung, Platzierung, Abmessungen usw.) vor. Die Lieferung erfolgt erst, nachdem der Kunde dieses zum Zeichen der Annahme unterschrieben und zurückgeschickt hat;
- nachdem die Planung, der Kostenvorschlag und eine Vorauszahlung akzeptiert wurden, kann ein Muster versandt werden;
- sobald der Verkäufer eine Vorauszahlung von 50 % der Gesamtkosten erhalten hat, kann die Produktion des Artikels beginnen;
- das Lieferdatum wird nach der Freigabe der endgültigen Gestaltung und/oder des Musters vereinbart;
- der Verkäufer behält sich in Bezug auf den Versand der bestellten Mengen für jeden einzelnen Artikel einen Toleranzwert von +/-10 % für Produkte aus den Katalogen/Preislisten Sambonet, Paderno, Arthur Krupp und Rosenthal und von +/-2 % für die Produkte aus dem Katalog/der Preisliste von Ercuis, mit Aufrundung auf die nächsthöhere Einheit vor;
- Die Kosten für die kundenspezifische Auftragsstellung (z. B. Etikettierung, Verpackung, Palettierung und/oder andere nicht standardisierte Anforderungen) gehen zu Lasten des Kunden;
- für Rosenthal-Markenprodukte beläuft sich die Mindestbestellmenge für die erste Lieferung mit kundenspezifischen Modellen oder Designs auf 120 Stück pro Artikel (für jede Nachbestellung beträgt die Mindestmenge 120 Stück);
- der Restbetrag ist vor der Auslieferung zu zahlen.
- 3.3. Die kundenindividuellen Artikel werden mit den Unterzeichnungen der Bestellung bzw. des Kostenvorschlags als bestätigt angesehen und können nicht storniert werden.
- 3.4. Die kundenindividuellen Artikel können nicht zum Umtausch oder zur Kostenrückerstattung zurückgegeben werden, es sei denn, sie weisen Produktionsmängel auf, die von der Qualitätskontrolle des Verkäufers anerkannt wurden.

4. BESTELLUNGEN VON KUNDENINDIVIDUELLEN SAMBONET- UND TAILOR-MADE PRODUKTEN

- 4.1. Die unten angegebenen Kosten sind als Festpreise zu verstehen.
- 4.2. Wellenschliff Obstmesser: wenn nicht serienmäßig vorgesehen, Aufpreis von € 0,65 pro Stück.
- 4.3. Gravur mit Pantograph/Laser:
- Einrichtungskosten: € 70,00;
- Gravurkosten: Besteck € 0,50 pro Stück - Geschirr, sofern Gravur möglich, € 1,00 pro Stück;
- Mindestmengen: Besteck 100 Stück je Artikel - Geschirr 10 Stück je Artikel.
- 4.4. Stanzungen:
- Punzen: erste Punze € 300,00 - jede weitere € 150,00;
- Stanzkosten: Besteck € 0,50 pro Stück - Geschirr: bitte Kostenvorschlag anfordern;
- Mindestmengen:
- Erstbestellung: Besteck 1.000 Stück je Artikel - Messer mit Hohlheftgriff 800 Stück je Artikel;
- Folgebestellungen: Besteck 100 Stück je Artikel - NICHT stanzbare Messer mit Hohlheftgriff (nur Pantograph oder Laser).
- 4.5. Arten Standardgravuren Tailor-Made:
- Auf dem vorderen Ende des Besteckgriffs: eines der Standardlogos oder das Monogramm (zwei Buchstaben) mit Standardschriftarten;
- Auf dem hinteren Ende des Besteckgriffs: Datum im Standardformat, mit einer Standardschriftart.
Kosten der Gravur Tailor-Made:
1. € 20 für Gravuren auf dem Ende des Besteckgriffs / Vorderseite;
2. € 20 für Gravuren auf dem Ende des Besteckgriffs / Hinterseite;
3. € 40 für Gravuren auf dem Ende des Besteckgriffs / Vorder- und Hinterseite.
Mindestbestellung für lose Artikel Tailor-Made:
4. 6 St. für die Artikel in Alpaca, in Vielfachstückelungen von 6 St.;
5. 12 St. für alle anderen Artikel, in Vielfachstückelungen von 12 St.;
- Anwendung der Preise für die Gravur Tailor-Made auf die einzelne Bestellung:
- Nur einmalige Zahlung für jede Art von Gravur, wie in den Punkten 1,2,3 angeführt, unabhängig von der Stückzahl bis zu 150 St.; bei mehr als 150 St. und Vielfachen von 150 St. werden die Kosten für die Gravur erneut veranschlagt;
- Eine einmalige Gebühr, unabhängig von der Anzahl der Artikel, wenn die unter den Punkten 4 und 5 angegebene Mindestabnahmemenge überschritten wird.

5. PRODUKTE DER MARKE ERCUIS: VOLLSILBER, VERGOLDETE TEILE UND KOLLEKTIONEN MIT EDELMATERIALIEN

- 5.1. Die in der Preisliste aufgeführten Verkaufspreise basieren auf dem aktuellen Gold- und Silberpreis vom 01.01.2025 und werden nur zur Information angegeben.
- 5.2. Der Verkäufer behält sich daher die Möglichkeit vor, den Verkaufspreis des Angebots entsprechend den Marktpreisen der genannten Edelmetalle anzupassen.
- 5.3. Alle Angebote in Bezug auf Edelmateriale haben eine zeitlich befristete Gültigkeit von 7 Tagen.
- 5.4. Mindestbestellung: Die Mindestmenge wird bei einer Bestellung mitgeteilt.

6. ZAHLUNGSKONDITIONEN

- 6.1. Die Bezahlung der Rechnung muss innerhalb der zwischen den Parteien zuvor vereinbarten Zahlungsfrist erfolgen. Der Verkäufer behält sich das Recht vor, für jegliche Bestellung eine Vorauszahlung oder eine Anzahlung zu verlangen.
- 6.2. Eventuelle Beanstandungen können in keinem Fall den Aufschub oder die Unterbrechung der Zahlungen zur Folge haben.
- 6.3. Bei Zahlungsverzögerungen ist der Kunde im Übrigen gegenüber dem Verkäufer rechtmäßiger Schuldner einer pauschalen Erstattung von Mahnauflagen, die sich auf € 40,00 beläuft. Wenn die Mahnauflagen den oben genannten Betrag überschreiten, hat der Verkäufer das Recht eine weitere Erstattung einzufordern. Im Falle eines Zahlungsverzugs werden Verzugszinsen in der in Art. 5 der (italienischen gesetzestretenden Verordnung) D.Lgs. 231/2002 und nachfolgenden Änderungen gemäß D.Lgs. 192/2012 vorgesehenen Höhe zuzüglich 8% fällig.
- 6.4. Die dem Verkäufer geschuldeten Zahlungen können ohne schriftliche Vereinbarung des Verkäufers weder ausgesetzt werden, noch mit einem Rabatt oder einer Vergütung verrechnet werden.

- 6.5. Der säumige Kunde ist verpflichtet, auf eigene Kosten und Risiko die nicht bezahlten Artikel zurückzugeben. Beanstandet der Verkäufer die Produkte, so ist er von der Verpflichtung zur Rückzahlung der vom Kunden erhaltenen Vorschüsse befreit, soweit diese auf den vom Kunden geschuldeten Schadensersatzbetrag und die Zinsen (für Rückgabe- oder Reparaturkosten) angerechnet werden können.
- 6.6. Im Falle der Nichtzahlung des vollständigen oder teilweisen Rechnungsbetrags oder einer Verschlechterung der finanziellen Lage des Kunden hat der Verkäufer auch die Befugnis:
- laufende Bestellungen und Lieferungen zu unterbrechen oder zu annullieren;
- rechtmäßig die sofortige Zahlung der gesamten verbleibenden, vom Kunden geschuldeten Beträge von anderen laufenden Verträgen einzufordern;
- die Artikel einzubehalten, bis der Betrag vollständig gezahlt ist;
- eine Vorauszahlung für weitere Bestellung zu fordern;
- eine Zahlungsgarantie zu verlangen.

7. VERBOT DES VERKAUFS/DER WIEDERAUSFUHR

- 7.1. Der Kunde wird weder direkt noch indirekt in die Russische Föderation und/oder zur Verwendung in der Russischen Föderation noch nach Weißrussland und/oder zur Verwendung in Weißrussland Waren verkaufen, exportieren oder wiederausführen, die unter oder im Zusammenhang mit diesen Allgemeinen Bedingungen geliefert werden und in den Anwendungsbereich der Verordnung (EU) Nr. 833/2014, des Artikels 12g der Verordnung (EU) Nr. 833/2014 des Rates in der jeweils gültigen Fassung und/oder des Artikels 8g der Verordnung (EG) Nr. 765/2006 in der jeweils gültigen Fassung fallen, sowie unter alle anderen und/oder zusätzlichen Rechtsvorschriften, die in diesem Zusammenhang erlassen werden können.
- 7.2. Der Kunde verpflichtet sich, nach besten Kräften sicherzustellen, dass der Zweck von Absatz 7.1 nicht durch Dritte in der Handelskette, einschließlich etwaiger Wiederverkäufer, vereitelt wird.
- 7.3. Jeder Verstoß gegen die Absätze 7.1 und 7.2 stellt einen schwerwiegenden Verstoß gegen einen wesentlichen Bestandteil dieser Allgemeinen Geschäftsbedingungen und des auf ihrer Grundlage geschlossenen Vertrages dar, und der Verkäufer ist berechtigt, angemessene Rechtsmittel zu ergreifen, einschließlich, aber nicht beschränkt auf: (i) Kündigung des Vertrags und/oder (ii) Verhängung einer Strafe in Höhe von 15 % des Gesamtwerts des genannten Vertrags oder des Preises der ausgeführten Waren, je nachdem, welcher Betrag höher ist; (iii) Meldung von Verstößen bei den zuständigen Behörden. Dies gilt in jedem Fall vorbehaltlich eines höheren Schadens, den der Verkäufer erleidet (einschließlich, insbesondere und ohne Einschränkung derjenigen, die sich aus etwaigen Sanktionen ergeben, die gegen den Verkäufer aufgrund des vorgenannten Verstoßes verhängt werden).
- 7.4. Der Kunde hat den Verkäufer unverzüglich schriftlich über etwaige Probleme bei der Anwendung der Absätze 7.1 und 7.2 zu informieren, einschließlich etwaiger einschlägiger Aktivitäten Dritter, die den Zweck von Absatz 7.1 unterlaufen könnten. Der Kunde muss dem Verkäufer Angaben über die Erfüllung der Verpflichtungen gemäß den Paragraphen 7.1 und 7.2 innerhalb von zwei (2) Wochen nach der einfachen schriftlichen Anforderung dieser Informationen zur Verfügung stellen.

8. EIGENTUMSVORBEHALT

- 8.1. Alle verkauften Produkte unterliegen dem Eigentumsvorbehalt: die gelieferten Waren bleiben bis zur vollständigen Bezahlung der Rechnung durch den Kunden Eigentum des Verkäufers.
- 8.2. Die Eigentumsübertragung erfolgt nach vollständiger Zahlung der Summe vonseiten des Käufers zur vereinbarten Frist, vorbehaltlich der Risikoubertragung zum Zeitpunkt der Auslieferung.
- 8.3. Die Risiken trägt der Kunde vom Zeitpunkt der Auslieferung der Artikel an, wobei der Eigentumsvorbehalt gilt. Der Kunde verpflichtet sich, die Artikel gegen alle Risiken zu versichern, die vom Zeitpunkt der Auslieferung an auftreten oder verursacht werden können.

9. LIEFERUNG DER ARTIKEL UND HÖHERE GEWALT

- 9.1. Wenn keine anderen Vereinbarungen getroffen werden, gelten die Incoterms FCA Orfengo. Der Kunde trägt die Kosten und das Risiko des Transports. Alle Kosten und Gebühren jeglicher Art im Rahmen des Transports obliegen dem Kunden.
- 9.2. Im Falle von Verkäufen mit EXW- und FCA-Rücksendungen verpflichtet sich der Kunde, dem Verkäufer innerhalb von 90 Tagen ab dem Datum der Verkaufsrechnung (Dlgs 87/2024 - Dlgs 471/97) alle erforderlichen Nachweise dafür vorzulegen, dass die Waren das italienische Zollgebiet verlassen und im ausländischen Bestimmungsland ausgeliefert wurden. Bei Nichteinhaltung der oben beschriebenen Bedingungen berechnet der Verkäufer innerhalb von 30 Tagen nach Ablauf der 90 Tage die Mehrwertsteuer zum geltenden italienischen Satz.
- 9.3. Die Liefertermine sind so genau wie möglich anzugeben, hängen aber von den Materialbeschaffungs- und Transportbedingungen des Verkäufers ab. Der Verkäufer bemüht sich aufs Äußerste die Auslieferungstermine einzuhalten.
- 9.4. Die Überschreitung der vorgesehenen Auslieferungszeiten verpflichten den Verkäufer in keinem Fall zu Straf-Schadensersatz- und Zinszahlungen. In solchen Fällen können die laufenden Bestellungen auch nicht ausgesetzt oder storniert werden. In jedem Fall kann die vereinbarte Lieferung nur erfolgen, wenn der Kunde alle seine Verpflichtungen gegenüber dem Verkäufer pünktlich erfüllt hat.
- 9.5. Wenn der Verzug oder die mangelnde Erfüllung der Vertragspflichten höherer Gewalt zuzuschreiben sind, kann der Verkäufer im folgenden Sinn nicht dafür verantwortlich gemacht werden; a) wenn diese Verhinderung außerhalb seiner Kontrolle liegt; b) wenn die Verhinderung zum Zeitpunkt der Vertragsschließung nicht vorhersehbar war und c) wenn die Auswirkungen der Verhinderung nicht vermieden oder umgangen werden konnten. Bis zum Beweis des Gegenteils zählen beispielsweise folgende Ereignisse zu höherer Gewalt: Krieg, Aufruhr, kommerzielle Engpässe, Embargo, Brand, Zerstörung an Geräten, Streik, Handlungen rechtlicher Behörden, Einhaltung jeglichen Gesetzes oder Regierungserlasses, Epidemie, Pandemie oder Naturkatastrophe. In solchen Fällen kann der Verkäufer bei umgehender Mitteilung an die andere Vertragspartei die Erfüllung seiner Vertragspflichten aussetzen und die Lieferfrist kann um dieselbe Zeit verschoben werden, die der Vorfall andauert. Sofern nichts anderes schriftlich vereinbart wurde, gilt der Vertrag nach Ablauf der Aussetzungsfrist als ohne weitere Mitteilung beendet.
- 9.6. Der Verkäufer kann den Vertrag auch dann auflösen, wenn die Leistungserbringung aufgrund unvorhersehbarer, von ihm unabhängiger Umstände objektiv gesehen zu aufwändig wäre.
- 9.7. Jede Änderung einer Bestellung hat eine Änderung des Liefertermins zur Folge.
- 9.8. Die Bestellungen können in mehreren Kartonen oder in mehreren Lieferungen erfolgen. Darüber hinaus wird zwischen den Parteien vereinbart, dass, wenn der Kunde die bestellten Produkte nicht zu den festgelegten Konditionen entgegen nimmt, der Verkäufer dem Kunden in Rechnung stellt:
- Aufbewahrungskosten in Höhe von 5% des Betrags der Bestellung, ausschließlich Steuer, für jeden Monat Verspätung;
- jede weitere Ausgabe für Transport.

10. LIEFERBEDINGUNGEN VON PRODUKTEN DER MARKEN SAMBONET/PADERNO/ARTHUR KRUPP/ROSENTHAL

Die Ware aus den Katalogen Sambonet/Paderno/Arthur Krupp/Rosenthal erfolgt frei Haus durch einen vom Verkäufer beauftragten Kurierdienst, unter den in der nachstehenden Tabelle genannten Bedingungen. Für alle anderen Kataloge/Marken gilt hingegen die Bedingung unter Punkt 9.1.

| GRUPPE | LÄNDER | NETTO- WARENWERT FREI HAUS | Bearbeitungsgebühr, für Bestellungen unter dem frei- Haus Betrag ** |
|--------|--|----------------------------------|---|
| A | Italien, Deutschland, Österreich, Frankreich, Niederlande, Belgien, Luxemburg | 500€ | 20€ |
| B | Spanien, Portugal, Polen, Tschechische Republik, Slowakei, Ungarn, Rumänien, Slowenien, Kroatien, Bulgarien, Norwegen, Andorra, Großbritannien, Nordirland, Schweden | 800€ | 35€ |
| C | Griechenland, Irland, Lettland, Litauen, Estland, Dänemark, Finnland | 1.200€ | 60€ |

** Die Bearbeitungsgebühren für die Bestellung gelten für jede einzelne vom Kunden aufgebene Bestellung und werden auf der Rechnung gesammelt ausgewiesen.

11. RÜCKGABEN/REKLAMATIONEN

- 11.1. Die Ware ist bei Erhalt zu kontrollieren.
- 11.2. Bei mangelhaften oder beschädigten Paketen verpflichtet sich der Kunde:
- eindeutige und genaue Vorbehalte auf dem Transportdokument zu vermerken, falls bei den Artikeln ein Verlust oder ein Defekt festgestellt wurde;
 - diese Vorbehalte müssen im Beisein des Auslieferers festgestellt und vermerkt werden;
 - die Art der Artikel und die Anzahl der fehlenden oder defekten Teile müssen eindeutig angegeben werden.
 - seine Vorbehalte gegenüber dem Anbieter sind innerhalb von 48 Stunden schriftlich per E-Mail zu bestätigen.

In Ermangelung dieser Mitteilung verliert der Kunde im Falle eines dem Transport geschuldeten Verlusts oder Defekts sein Recht auf jegliche Beschwerde gegenüber dem Verkäufer. Die Formeln «unter Vorbehalt der Verpackung» oder «unter Vorbehalt weiterer Prüfungen» sind nicht zulässig und werden nicht berücksichtigt.

- 11.3. Reklamationen werden innerhalb von 15 Tagen ab Rechnungsdatum als letzte nicht verhandelbare Frist unter folgenden Bedingungen angenommen:
- Die Reklamation/ der Antrag auf Rücknahme der Ware erfolgt über das angeleitete Verfahren im Benutzerbereich der Webseite www.professional.sambonet.it;
 - Die Lieferung erfolgt frei unserem Werk;
 - Liegt die Verantwortung für die Rückgabe beim Kunden, stellt der Verkäufer 15 % des Nettopreises, jedoch mindestens € 25,00 als Bearbeitungskosten in Rechnung;
 - Liegt die Verantwortung nachgewiesenermaßen beim Verkäufer, wird die Ware ersetzt und dem Kunden frei Haus zugestellt;
 - Im Falle von Produkten, die zur Reparatur zurückgegeben werden und keiner Gewährleistung unterliegen, gehen die Kosten für Zu- und Rücksendung zu Lasten des Kunden;
 - Die Rückgaben werden einer Mengen- und Qualitätskontrolle unterzogen, und eventuell fehlende oder beschädigte Artikel sind vom Kunden zu zahlen;
 - Nicht angenommen werden Rücksendungen von Sonderartikeln (nicht im Katalog), gravierte Tailor-Made-Artikel, oder andere kundenindividuelle, sowie auslaufende Artikel.
- 11.4. Der Artikel kann nur gegen Vorlage eines Kaufnachweises beim Verkäufer zurückgegeben werden. Die Artikel müssen in ihren Originalverpackungen innerhalb von 8 Tagen ab der vom Verkäufer ausgestellten schriftlichen Zustimmung zurückgegeben werden.

12. GARANTIE - HAFTUNGSBESCHRÄNKUNGEN – PRODUKTSICHERHEIT

- 12.1. Der Verkäufer ist entsprechend seiner Rolle als Hersteller der Artikel versichert. Die Haftung des Verkäufers ist auf den Austausch von anerkannt defekter Ware beschränkt, sofern keine Veränderungen daran vorgenommen wurden. Jede andere Entschädigung ist ausgeschlossen.
- 12.2. Die Folgen von unangemessenen Lagerbedingungen sind nicht von der Garantie vonseiten des Verkäufers abgedeckt.
- 12.3. Die Schäden durch unsachgemäßen Gebrauch oder die Verwendung unter unangemessenen Bedingungen, die von der Gebrauchsanleitung abweichen, sind von der Garantie vonseiten des Verkäufers nicht abgedeckt. Der Verkäufer kann in keinem Fall für indirekte oder immaterielle Schäden jeglicher Natur von seinen Kunden, Vertretern, Angestellten, Nachfolgern oder Rechtsnachfolgern haftbar gemacht werden, wie unter anderem für Verlust, Kosten, Umsatz- bzw. Gewinnverlust des Kunden oder jedes Dritten im Rahmen seiner Vertragspflicht.
- 12.4. Die gesamte und kumulative Haftung des Verkäufers beträgt in Bezug auf die Vertragserfüllung maximal zehn Prozent (10%) des Bestellwerts. Die Fotografien des Artikels im Katalog gelten nicht als für den Vertrag verbindlich.
- 12.5. Die Maße, die Eigenschaften und die Abbildungen der Artikel sind unverbindlich und können aufgrund von technischen Produktionsanforderungen ohne Vorankündigung geändert werden. Angesichts der handwerklichen Fertigung der Artikel können sich leichte Unterschiede zwischen den verschiedenen Chargen des gleichen Artikels ergeben.
- 12.6. Die Ware ist für die Vermarktung in dem Land, in dem der Kunde ansässig ist, bestimmt. Wenn die Ware in einem anderen Land vermarktet wird, liegt es in der Verantwortung des Kunden, die in diesem Land geltenden Vorschriften einschließlich Zoll- und Einfuhrbestimmungen sowie das Risiko von Streitigkeiten jeglicher Art durch Dritte zu überprüfen. Es versteht sich, dass der Verkäufer für jede mögliche Streitigkeit, die durch den Verkauf der Waren in diesem anderen Land entstehen kann, schadlos gehalten wird.
- 12.7. Gemäß der Verordnung (EU) 2023/988 über die allgemeine Produktsicherheit kann der Kunde den Verkäufer unter der E-Mail-Adresse kontaktieren.product.safety@sambonet.it und über QR-Codes weitere Informationen zu Produkten erhalten, die unter die genannte Verordnung fallen:

PRODUKTE MARKE PADERNO



PRODUKTE MARKE SAMBONET



13. GEISTIGES EIGENTUM

- 13.1. Der Verkäufer behält das alleinige Eigentum der Marken, Entwürfe, Pläne und Modelle und im Allgemeinen aller Dokumente jeder Art, die er dem Kunden ausgehändigt oder übermittelt hat.
- 13.2. Der Verkauf der Artikel beinhaltet nicht die Übertragung des geistigen Eigentums zugunsten des Kunden. Die Rechte auf geistiges Eigentum, seien sie eingetragen oder nicht, behält voll und ganz der Verkäufer. Der Verkäufer behält sich das Recht vor, im Falle eines Verstoßes gegen die Bestimmungen dieses Kapitels rechtliche Schritte einzuleiten.
- 13.3. Darüber hinaus ist es ausdrücklich untersagt, diese Marken und/oder jedes andere identische oder ähnliche Kennzeichen als Marke, Domainname oder für sonstige andere Zwecke zu imitieren bzw. zu vervielfältigen. Entsprechend dürfen Artikel, Zeichnungen, Entwürfe oder Pläne weder ausgeführt noch vervielfältigt bzw. ohne vorherige schriftliche Genehmigung vonseiten des Verkäufers ausgestellt werden, sie dürfen außerdem nicht als Berufung auf jegliche Rechte bezüglich des geistigen Eigentums jeglicher Art verwendet werden.
- 13.4. Werbeunterlagen, die sich auf die Produkte und den Markennamen beziehen, dürfen vom Kunden nur mit ausdrücklicher schriftlicher Zustimmung verwendet werden. Der Verkäufer kann in keinem Fall für den Ursprung der kopierten oder insbesondere im Internet mit seiner Marke verkauften Artikel haftbar gemacht werden; deren Kopie oder Verkauf stellt einen Verstoß gegen das Recht auf gewerbliches und geistiges Eigentum vonseiten Dritter dar.
- 13.5. Der Kunde erlaubt dem Verkäufer ausdrücklich anzugeben, dass letzterer im Namen des Kunden handelt und/oder dass der Kunde die Artikel des Verkäufers verwendet, und letzterer in kommerziellen Dokumenten, auf seiner Website und auf jedem anderen bereits vorhandenen oder künftigen Kommunikationsmittel den Kundennamen als Referenz nennen darf.
- 13.6. Die Art der dem Kunden bereitgestellten Leistungen und die Art der vom Kunden verwendeten Artikel des Verkäufers gelten nicht als vertrauliche Informationen.

14. PERSONENBEZOGENE DATEN

- 14.1. Mit dem Verkauf von Artikeln muss der Verkäufer eine bestimmte Anzahl an persönlichen Angaben vom Kunden erheben, die notwendig sind, um die Bestellungen verarbeiten und die Vertragspflichten des Verkäufers einhalten zu können.
- 14.2. Die vom Kunden bereitgestellten personenbezogenen Daten werden im Einklang mit der EU-Verordnung 2016/679 und der (italienischen gesetzestvertretenden Rechtsverordnung) D. Lgs Nr.196/2003 behandelt. Diese Daten sind Gegenstand einer elektronischen Verarbeitung und werden unter sicheren Bedingungen nach dem heutigen Stand der Technik und im Einklang mit den Verfügungen der DSGVO aufbewahrt. Der für die Datenverarbeitung Verantwortliche ist der Verkäufer (Kontaktinformationen folgen). Die Daten werden für den zur korrekten Verwaltung der Bestellungen notwendigen Zeitraum aufbewahrt. Die personenbezogenen Daten werden in keinem Fall ins Ausland weitergegeben, können aber Gegenstand einer Übertragung an einen gewerblichen Übernehmer und/oder Käufer im Rahmen einer Umstrukturierung sein.
- 14.3. Der Kunde hat das Recht auf Zugriff, Änderung, Berichtigung und Löschung seiner Daten, das er gegenüber dem

15. VERTRAULICHKEIT

- 15.1. Der Kunde behandelt jede Information, die ihm im Zusammenhang mit der Ausführung des Vertrags oder einer Bestellung zugetragen werden könnte, als streng vertraulich und verpflichtet sich, diese nicht weiterzugeben. Diese Klausel gilt so lange, wie die vertraulichen Informationen nicht vom Verkäufer an die Öffentlichkeit gebracht werden.

16. ANWENDBARES RECHT - LÖSUNG VON STREITFÄLLEN

- 16.1. Für alle Streitigkeiten oder Meinungsverschiedenheiten gilt das italienische Recht, und die ausschließliche Zuständigkeit liegt beim Gericht von Novara.
- 16.2. Bei ausländischen Kunden gilt das italienische Recht nicht nur für Streitigkeiten, sondern für das gesamte Vertragsverhältnis, unter Ausschluss der Anwendung des Wiener Kaufrechtsübereinkommens.

FRA CONDITIONS GÉNÉRALES DE VENTE

1. APPLICATION DES CONDITIONS GÉNÉRALES

- 1.1. Les présentes Conditions Générales de vente sont applicables à toute commande/confirmation de commande/fourniture effectuée au Client.
- 1.2. La transmission d'une commande, la confirmation de la commande et la fourniture comportent la lecture et l'acceptation, sans réserve, des présentes Conditions Générales, à l'exclusion de toute autre clause ou condition qui devra être considérée comme non apposée. La non-application d'une disposition des présentes Conditions Générales ne constitue pas une renonciation à l'éventuelle application future de ladite disposition de la part du Vendeur.
- 1.3. Les présentes Conditions Générales de Vente prennent effet le 1er janvier 2025, annulant et remplaçant toutes les conditions générales précédentes du Vendeur.
- 1.4. Le Vendeur se réserve le droit indiscutable de modifier à tout moment les présentes Conditions Générales de vente, en le communiquant par écrit au Client.

2. OFFRE/COMMANDE/CONFIRMATION DE COMMANDE

- 2.1. L'acceptation de l'offre et/ou de la confirmation de commande (avec les modalités qu'elle contient) entraîne à tous les effets un contrat de vente conforme aux présentes Conditions Générales de Vente.
- 2.2. Les offres sont libres et n'engagent pas à passer une commande.
- 2.3. Les devis sont valables pendant 30 jours à compter de leur date d'émission, sauf indications contraires contenues dans ces derniers.
- 2.4. Les prix sont entendus nets de TVA, et ne comprennent pas les frais de douane, les frais d'assurance et les frais de transport.
- 2.5. Les commandes sont soumises à l'approbation du Vendeur. Le montant minimum de commande est de 100 € net (à l'exclusion des frais de transport, assurance et emballage).
- 2.6. L'emballage standard est gratuit. Les éventuelles demandes d'emballages spéciaux seront à la charge du Client. Pour les conditions, les coûts et les détails spécifiques, veuillez-vous référer au document «Charte des services» disponible auprès du service clients du Vendeur et sur le portail clients.
- 2.7. Le Client devra envoyer la commande, via le Portail clients, à l'adresse <https://professional.sambonet.it> ou sous forme écrite par mail, en précisant ce qui suit : la quantité et le type de produits commandés ; le lieu de livraison et de facturation.
- 2.8. Le Client prend acte que l'offre/la confirmation de commande est considérée comme étant acceptée au moment de la réception, sauf éventuel signalement le jour de la réception de cette dernière.
- 2.9. Les promotions de produits mises en place par le Vendeur sont régies par des conditions spécifiques, communiquées au client via les canaux dédiés, et sont soumises à des limitations temporelles qui ne seront pas valables ou applicables au-delà de la date de validité de ces dernières.

3. COMMANDES DE PRODUITS PERSONNALISÉS

- 3.1. Tous les articles qui diffèrent par rapport au catalogue doivent être considérés comme « personnalisés ».
- 3.2. Le Vendeur est en mesure de réaliser des produits personnalisés sur demande du client, après étude de son Centre de Style, aux conditions suivantes :
- Le Vendeur fournira au Client une fiche dessin avec l'indication de tous les paramètres nécessaires (dessin, position, dimensions, etc.) et procédera à la fourniture uniquement à la réception de cette dernière signée pour acceptation;
 - envoi éventuel d'un échantillon, après approbation de la fiche correspondante, du devis et du versement de l'acompte ;
 - mise en production à partir de la réception de la part du Vendeur de l'acompte égal à 50 % du montant total de la commande ;
 - accord sur la Date de Livraison après l'approbation du dessin exécutif et/ou de l'échantillon ;
 - faculté pour le Vendeur d'appliquer, pour chaque article individuel, une tolérance égale à +/-10 % pour les produits présents dans les catalogues Sambonet, Paderno, Arthur Krupp et Rosenthal et égale à +/-2 % pour les produits présents dans le catalogue Ercois, avec arrondissement à l'unité supérieure, à l'expédition des quantités commandées ;
 - les coûts de préparation personnalisée de la commande (par exemple étiquetage, conditionnement, emballage, palettisation et/ou toute autre demande en dehors de la normalité) seront à la charge du Client ;
 - pour les produits de la marque Rosenthal, la quantité minimum de commande pour la première fourniture avec modèles ou dessins personnalisés est de 120 pièces par article (pour toute nouvelle commande éventuelle, la quantité minimum est de 120 pièces) ;
 - paiement du solde de la commande avant la livraison.
- 3.3. Les commandes de produits personnalisés sont considérées confirmées à partir de la signature de la commande et/ou du devis et ne peuvent pas être annulées.
- 3.4. Les produits personnalisés ne peuvent pas être retournés pour remplacement ou remboursement, sauf en cas de défaut de production reconnu par le contrôle qualité du Vendeur.

4. COMMANDES DE PRODUITS PERSONNALISÉS DES MARQUES SAMBONET ET TAILOR MADE

- 4.1. Les coûts indiqués ci-après doivent être considérés comme étant fixes.
- 4.2. Couteaux à dessert exécutés avec lame dentelée : si elle n'est pas prévue de série, avec facturation de 0,65 € par pièce.
- 4.3. Gravure pantographe/laser :
- coût installation : 70,00 € ;
- frais de gravure : couverts 0,50 € par pièce - plats et articles de table, si gravure faisable, 1,00 € par pièce ;
- quantité minimum : couverts 100 pièces par article - plats et articles de table 10 pièces par article.
- 4.4. Poinçonnage :
- coût poinçons : 300,00 € pour le premier poinçon, 150,00 € pour chaque poinçon supplémentaire ;
- coût poinçonnage : couverts 0,50 € par pièce - plats et articles de table : devis sur demande ;
- quantités minimales :
■ première commande : couverts 1000 pièces par article - couteaux poignée creuse 800 pièces par article ;
■ commandes suivantes : couverts 100 pièces par article - couteaux poignée creuse NON poinçonnables (uniquement pantographe ou laser).
- 4.5. Type de gravures Tailor Made standard :
- Au recto du manche : un des logos standards ou un monogramme (deux lettres) en utilisant l'une des polices standards ;
- Au verso du manche : la date au format standard en utilisant l'une des polices standards ;
Coût de la gravure Tailor Made :
1. 20 € pour les gravures au recto du manche ;
2. 20 € pour les gravures au verso du manche ;
3. 40 € pour les gravures au recto et au verso du manche.
Minimum d'achat pour des articles en vrac Tailor Made :
4. 6 pièces pour les références en maillechort, par multiples de 6 pièces ;
5. 12 pièces pour toutes les autres références, par multiples de 12 pièces ;
Application du coût de la gravure Tailor Made sur chaque commande :
- Un coût unique pour chaque type de gravure, indiqués aux points 1,2,3, quel que soit le nombre de pièces jusqu'à 150 pièces ; au-delà de 150 pièces et par multiples de 150 pièces, le coût de la gravure sera à nouveau appliqué ;
- Un coût unique quel que soit le nombre de références – à condition qu'il soit supérieur au minimum d'achat indiqué aux points 4 et 5.

5. PRODUITS DE LA MARQUE ERCUIS :

ARGENT MASSIF, PIÈCES DORÉES ET COLLECTIONS AVEC MATÉRIAUX PRÉCIEUX

- 5.1. Les prix de vente indiqués en catalogue sont basés sur la cotation de l'or et de l'argent en date du 01/01/2025 et sont fournis exclusivement à titre indicatif.

- 5.2. Le Vendeur se réserve donc le droit de mettre à jour le prix de vente de l'offre sur la base de l'évolution des cotations de marché des métaux précieux susmentionnés.
- 5.3. Toutes les offres concernant les métaux précieux auront une validité temporelle limitée à 7 jours.
- 5.4. Minimum de commande : la quantité minimum sera communiquée au moment de l'offre.

6. PAIEMENT

- 6.1. Le paiement de la facture est dû dans le délai de paiement préalablement convenu entre les parties. Le Vendeur se réserve le droit de demander un paiement anticipé ou un acompte pour n'importe quelle commande.
- 6.2. Les éventuelles réclamations du Client ne pourront en aucun cas avoir pour effet le report ou la suspension des paiements.
- 6.3. Le Client en situation de retard de paiement sera par conséquent débiteur de plein droit, vis-à-vis du Vendeur, d'une indemnisation forfaitaire pour frais de rappel égale à 40,00 €. Si les frais de rappel dépassent ce montant, le Vendeur sera en droit de réclamer une indemnisation supplémentaire. En cas de retard de paiement seront dus les intérêts de retard au taux visé à l'article 5 du Décret législatif italien n° 231/2002 tel que modifié ultérieurement par le Décret législatif italien n° 192/2012, majoré de 8%.
- 6.4. Les paiements qui sont dus au Vendeur ne peuvent pas être suspendus ni faire l'objet de toute réduction ou compensation sans l'accord écrit du Vendeur.
- 6.5. Le Client en défaut devra rendre, à ses frais et risques, les produits non payés. Si le Vendeur revendique les produits, il est libéré de l'obligation de restituer les acomptes reçus du Client, dans la mesure où leur montant peut-être compensé avec le montant dû pour les dommages et intérêts dus par le Client (pour les frais de retour ou de réparation).
- 6.6. En cas de non-paiement total ou partiel de la facture, ou de dégradation de la situation financière du Client, le Vendeur aura également le droit :
 - de suspendre ou d'annuler les commandes et les livraisons en cours ;
 - d'exiger de plein droit le paiement immédiat de la totalité des montants restant dus par le Client, relatifs à d'autres contrats en cours ;
 - de retenir les produits jusqu'au paiement total du prix ;
 - d'exiger un paiement anticipé pour les commandes ultérieures ;
 - d'exiger des garanties de paiement.

7. INTERDICTION DE VENTE/RÉEXPORTATION

- 7.1. Le Client ne vendra, n'exportera ni ne réexportera, directement et/ou indirectement, vers la Fédération de Russie et/ou en vue d'une utilisation dans la Fédération de Russie, ni vers la Biélorussie et/ou en vue d'une utilisation en Biélorussie, aucune marchandise, fournie en vertu des présentes Conditions Générales ou en relation avec ces dernières, qui entre dans le champ d'application du Règlement (UE) n° 833/2014, de l'article 12-octies du Règlement (UE) n° 833/2014 du Conseil tel que modifié et intégré ultérieurement et/ou de l'article 8-octies du Règlement (CE) n° 765/2006 tel que modifié et intégré ultérieurement, ainsi que de toute disposition réglementaire différente et/ou ultérieure qui pourrait être prise à cet égard.
- 7.2. Le Client s'engage à faire tout son possible pour garantir que l'objectif du paragraphe 7.1 ne soit pas annulé par des tiers en aval de la chaîne commerciale, y compris les éventuels revendeurs.
- 7.3. Toute violation des paragraphes 7.1 et 7.2 constituera une violation grave d'un élément essentiel des présentes Conditions Générales et du contrat conclu en vertu de ces dernières, et le Vendeur aura le droit d'adopter des remèdes appropriés, parmi lesquels, à titre indicatif et non exhaustif : (i) la résiliation du contrat ; et/ou (ii) l'application d'une pénalité égale à 15 % de la valeur totale du contrat susdit ou du prix des marchandises exportées, si supérieur ; (iii) la notification des violations aux autorités compétentes. Dans tous les cas sans préjudice de tout dommage plus important subi par le Vendeur (y compris, à titre indicatif et non exhaustif, celui dérivant d'éventuelles sanctions infligées au Vendeur à cause de la violation susmentionnée).
- 7.4. Le Client doit informer immédiatement par écrit le Vendeur des éventuels problèmes d'application des paragraphes 7.1 et 7.2, y compris les éventuelles activités pertinentes de la part de tiers qui pourraient compromettre l'objectif du paragraphe 7.1. Le Client devra mettre à disposition du Vendeur les informations relatives au respect des obligations visées aux paragraphes 7.1 et 7.2 dans un délai de deux (2) semaines à compter de la simple demande de ces informations.

8. RÉSERVE DE PROPRIÉTÉ

- 8.1. Tous les produits vendus sont soumis à la réserve de propriété : la marchandise fournie reste la propriété du Vendeur jusqu'au paiement intégral de la facture de la part du Client.
- 8.2. Le transfert de propriété est subordonné au paiement complet du prix correspondant de la part du Client dans le délai convenu, sans préjudice du transfert des risques à la date de livraison.
- 8.3. À partir de la livraison des produits, les risques sont à la charge du Client, sans préjudice de la réserve de propriété. Le Client s'engage à assurer les produits contre tous les risques qu'ils peuvent subir ou causer à partir de leur livraison.

9. LIVRAISON DES PRODUITS ET CAS DE FORCE MAJEURE

- 9.1. Sauf accord contraire, l'incoterm est FCA Orfengo. Le transport est effectué aux frais et aux risques du Client. Tous les frais et taxes de quelque nature que ce soit relatifs au transport sont à la charge du Client.
- 9.2. En cas de vente avec retours EXW et FCA, le Client s'engage à fournir au Vendeur, dans un délai de 90 jours à compter de la date de la facture de vente (Décret législatif italien 87/2024 - Décret législatif italien 471/197), toutes les preuves nécessaires de sortie effective de la marchandise du territoire douanier italien et de livraison effective au sein de l'Etat étranger de destination. En cas de non-respect des termes décrits ci-dessus, le vendeur facturera, dans un délai de 30 à 90 jours, la TVA au taux italien en vigueur.
- 9.3. Les délais de livraison sont indiqués de la manière la plus exacte possible, mais dépendent des conditions d'approvisionnement et de transport du Vendeur. Le Vendeur s'engage à faire preuve de la plus grande diligence afin de respecter les livraisons.
- 9.4. Le dépassement des temps de livraison n'entraîne en aucun cas la responsabilité du Vendeur, ni le versement de pénalités ou d'intérêts, ni ne pourra faire l'objet de demandes de dommages et intérêts. Dans ces cas n'est pas non plus prévue la suspension ou l'annulation des commandes en cours. Dans tous les cas, la livraison dans les délais pourra être effectuée uniquement si le Client s'est ponctuellement conformé à toutes ses obligations vis-à-vis du Vendeur.
- 9.5. Le Vendeur ne sera pas tenu responsable si l'exécution retardée ou la non-exécution des obligations contractuelles dépend de causes de Force Majeure, dans la mesure où il peut démontrer : a) que cet empêchement est indépendant de sa volonté ; b) qu'il ne pouvait pas être raisonnablement prévu au moment de la conclusion du contrat ; c) que les effets de l'empêchement n'auraient pas raisonnablement pu être évités ou surmontés. Sauf preuve du contraire, les événements de force majeure sont réputés inclure, à titre d'exemples, la guerre, l'émeute, les restrictions commerciales, l'embargo, l'incendie, la destruction d'équipements, la grève, l'acte d'une autorité légale, le respect d'une loi ou d'un ordre gouvernemental, l'épidémie, la pandémie, la catastrophe naturelle ou l'événement naturel extrême.
- Dans ces cas, le Vendeur pourra suspendre l'exécution de ses obligations contractuelles, en avertissant par écrit l'autre partie, et le délai pour l'exécution de la fourniture pourra être prorogé pour une durée égale à la durée de l'événement. Sauf accord contraire écrit, une fois la période de suspension inutilement écoulée, le contrat sera considéré résilié sans avis ultérieur.
- 9.6. Le Vendeur pourra également résilier le contrat si l'exécution de la prestation est objectivement rendue trop onéreuse par une circonstance imprévisible indépendante de sa volonté.
- 9.7. Toute modification de commande donnera lieu à une modification conséquente des délais.
- 9.8. Les commandes peuvent être livrées en plusieurs emballages et/ou en plusieurs livraisons. Il est par conséquent convenu entre les parties que si le Client ne prend pas possession des produits commandés selon les conditions acceptées ci-dessus, le Vendeur facturera au Client :
 - les frais de conservation correspondant à 5 % du montant de la commande, taxes exclues, par mois de retard, tout mois déjà entamé étant dû ;
 - tout frais de transport ultérieur sera à la charge du Client.

10. CONDITIONS DE LIVRAISON DES PRODUITS DE LA MARQUE SAMBONET/PADERNO/ARTHUR KRUPP/ROSENTHAL

La marchandise présente dans les catalogues Sambonet/Paderno/Arthur Krupp/Rosenthal est livrée franco-domicile Client par un transporteur contracté avec le Vendeur dans les conditions indiquées dans le tableau ci-dessous. Pour tous les autres catalogues/marques, en revanche, la condition du point 9.1 s'applique.

| GRUPE | PAYS | PORT FRANC VALEUR NETTE MARCHANDISE | Frais de gestion de la commande, pour des commandes inférieures au Port Franc ** |
|-------|---|-------------------------------------|--|
| A | Italie, Allemagne, Autriche, France, Pays-Bas, Belgique, Luxembourg | 500€ | 20€ |
| B | Espagne, Portugal, Pologne, République Tchèque, Slovaquie, Hongrie, Roumanie, Slovaquie, Croatie, Bulgarie, Norvège, Andorre, Royaume-Uni, Irlande du Nord, Suède | 800€ | 35€ |
| C | Grèce, Irlande, Lettonie, Lituanie, Estonie, Danemark, Finlande | 1.200€ | 60€ |

** Les frais de gestion de la commande s'entendent par commande individuelle transmise par le client et seront facturés sur la facture de manière cumulative.

11. RETOURS/RÉCLAMATIONS

- 11.1. La marchandise doit être contrôlée à sa réception.
- 11.2. En cas de colis défectueux/endommagés, le Client s'engage :
 - à émettre des réserves claires et précises sur le reçu de livraison en cas de perte ou de défaillance constatée sur les produits ;
 - à constater et rédiger ces réserves en présence du transporteur ;
 - à indiquer clairement la nature des produits et le nombre de pièces manquantes ou défectueuses ;
 - à confirmer dans les 48 heures ses réserves au Vendeur sous forme écrite, par courriel.
- En absence de quoi le Client perdra le droit de procéder à toute plainte contre le Vendeur en cas de perte ou de défaillance résultant du transport.
- Les formules « avec réserve de déballage » ou « avec réserve de vérification ultérieure » ne sont pas admises et n'ont aucune valeur.
- 11.3. Les réclamations seront acceptées dans les 15 jours à compter de la date de la facture, dernier délai non négociable, aux conditions suivantes :
 - la réclamation / demande de retour de marchandise doit être faite à travers la procédure guidée à l'adresse www.professional.sambonet.it dans l'espace utilisateur ;
 - le retour de la marchandise doit être départ notre usine ;
 - En cas de responsabilité du client, le Vendeur facturera 15 % du prix net, avec un minimum de 25 € pour les coûts de gestion ;
 - en cas de responsabilité avérée du Vendeur, la marchandise sera remplacée et retournée franco domicile client ;
 - pour les produits retournés pour réparation hors garantié, les frais de transport aller-retour sont à la charge du client ;
 - les retours seront soumis à un contrôle de quantité et de qualité, et les éventuels articles manquants ou détériorés resteront à la charge du Client ;
 - les retours d'articles spéciaux (hors catalogue), gravés Tailor Made, avec d'autres personnalisations ou hors production ne seront pas acceptés.
- 11.4. Le produit pourra être rendu uniquement sur preuve d'achat auprès du Vendeur. Les produits devront être rendus dans leur emballage d'origine dans un délai de 8 jours à compter de l'accord écrit du Vendeur.

12. GARANTIES - LIMITES DE RESPONSABILITÉ - SÉCURITÉ DES PRODUITS

- 12.1. Le Vendeur est assuré conformément à sa qualité de fabricant de produits. La responsabilité du Vendeur est limitée au remplacement de la marchandise reconnue comme étant défectueuse, à condition qu'elle n'ait pas subi de modifications et à l'exclusion de toute autre indemnité.
- 12.2. Le Vendeur ne fournit aucune garantie contre les conséquences de l'éventuel non-respect des conditions de stockage.
- 12.3. Le Vendeur ne garantit pas les dommages dérivant d'une utilisation inappropriée ou dans des conditions inappropriées ou ne correspondant pas au mode d'emploi. Le Vendeur ne sera en aucun cas responsable envers les Clients, ses agents, employés, successeurs ou ayants-droits, de tout dommage indirect ou immatériel de quelque nature que ce soit, y compris, sans s'y limiter, les pertes, les coûts, les dommages, les pertes de revenu ou de profit, subis par le Client ou par tout tiers dans le cadre de ses obligations contractuelles.
- 12.4. La responsabilité totale et cumulée du Vendeur dans le cadre de l'exécution du Contrat ne pourra en aucun cas excéder le dix pour cent (10 %) du montant de la commande. Les photos des produits du catalogue n'ont pas de valeur contractuelle.
- 12.5. Les mesures, caractéristiques et illustrations des produits sont fournies à titre indicatif et soumises à des variations sans préavis si des exigences techniques et de production l'exigent. En considération du fait que la production est artisanale, il pourrait y avoir de légères différences entre les différents lots d'un même produit.
- 12.6. La marchandise est destinée à la commercialisation dans le Pays où se trouve le siège du Client. Si la marchandise est commercialisée dans un Pays différent, il incombe au client de vérifier les réglementations applicables dans ce Pays, y compris les réglementations en matière d'importation, ainsi que le risque de contestations de la part de tiers pour quelque raison que ce soit, restant entendu que le Vendeur sera indemnisé et déchargé de toute responsabilité par le client pour tout ce qui est causé par la vente de la marchandise dans ledit Pays différent.
- 12.7. Conformément au Règlement (UE) 2023/988 relatif à la sécurité générale des produits, le Client pourra contacter le Vendeur à l'adresse mail suivante product.safety@sambonet.it et trouver toutes les informations pour les produits concernés par le règlement précité grâce aux codes QR dédiés :

PRODUITS DE LA MARQUE PADERNO



PRODUITS DE LA MARQUE SAMBONET



13. PROPRIÉTÉ INTELLECTUELLE

- 13.1. Le Vendeur détient la propriété intellectuelle des marques, des dessins, des brouillons, des plans de modèle et de manière générale de tous les documents de quelque nature que ce soit délivrés ou envoyés par le Vendeur au Client.
- 13.2. La vente des produits ne comporte aucun transfert de propriété intellectuelle en faveur du Client. Les droits de propriété intellectuelle, déposés ou non, restent la pleine et entière propriété du Vendeur. Le Vendeur se réserve le droit d'agir en justice en cas de violation des dispositions visées dans le présent chapitre.
- 13.3. Il est par conséquent expressément interdit d'effectuer tout reproduction, imitation de ces marques et/ou de tout autre signe distinctif d'identité ou similaire, à titre de marque, nom de domaine ou pour toute autre utilisation. De la même manière, les produits, les dessins, les brouillons, les plans ne peuvent pas être ni exécutés ni reproduits, ni représentés sans l'autorisation préalable écrite du Vendeur, ni même faire l'objet d'une revendication de quelque droit de propriété intellectuelle que ce soit, de quelque nature que ce soit.
- 13.4. Tout document publicitaire, relatif aux produits et à la marque, pourra être utilisé par le client uniquement après accord exprès et écrit. Le Vendeur ne pourra en aucun cas être tenu responsable de l'origine des produits copiés et vendus avec sa marque, en particulier sur Internet, qui s'avèrent être une violation de ses droits de propriété industrielle et intellectuelle de la part de tiers.

- 13.5. Le Client autorise expressément le Vendeur à indiquer qu'il intervient pour le compte du client et/ou que le client utilise les produits du Vendeur et à citer son nom comme référence dans les documents commerciaux, sur son site Internet et sur tout autre support de communication existant ou futur.
- 13.6. La nature des services réalisés par le Client et le type de produit du Vendeur utilisé par le Client ne constituent pas des informations confidentielles.
- 14. DONNÉES À CARACTÈRE PERSONNEL**
- 14.1. La vente de produits de la part du Vendeur nécessite la collecte d'un certain nombre d'informations à caractère personnel relatives au Client, nécessaires à l'administration correcte des commandes et au respect des obligations contractuelles du Vendeur.
- 14.2. Les données à caractère personnel fournies par le Client seront traitées dans le respect du Règlement (UE) n°2016/679 et du Décret législatif italien n° 196/2003. Ces données font l'objet d'une élaboration informatique et sont conservées en toute sécurité, selon les moyens actuels de la technique, dans le respect des dispositions du RGPD. Le responsable du traitement est le Vendeur (coordonnées à suivre). Les données sont conservées pour une durée raisonnable nécessaire à l'administration correcte des commandes. Les données à caractère personnel collectées ne font l'objet d'aucun transfert à l'étranger et pourront dans tous les cas faire l'objet d'une cession en faveur d'un cessionnaire d'entreprise et/ou d'un acheteur dans le cadre d'une restructuration.
- 14.3. Le Client dispose d'un droit d'accès, de modification, de rectification et d'effacement des données qui le concernent, qu'il peut exercer auprès du Vendeur par e-mail à l'adresse privacy@sambonet.it ou par courrier ordinaire.
- 15. CONFIDENTIALITÉ**
- 15.1. Le Client considérera comme strictement confidentielle et s'engage à ne pas divulguer toute information dont il pourrait avoir connaissance dans le cadre de l'exécution du Contrat ou d'une commande. Cette clause restera valide tant que les informations confidentielles ne seront pas mises dans le domaine public par le Vendeur.
- 16. DROIT APPLICABLE – RÉSOLUTION DES LITIGES**
- 16.1. Pour toute contestation ou litige s'applique la loi italienne et est exclusivement compétent le Tribunal de Novare.
- 16.2. En cas de clients étrangers, la loi italienne s'applique non seulement aux litiges, mais à l'entière du rapport contractuel, à l'exclusion de l'application de la Convention de Vienne relative à la vente de biens immobiliers.

ESP CONDICIONES GENERALES DE VENTA

1. APLICACIÓN DE LAS CONDICIONES GENERALES

- Las presentes Condiciones Generales de Venta se aplican a cualquier pedido/confirmación de pedido/ suministro realizado al cliente.
- La transmisión de un pedido, la confirmación del pedido y el suministro implican la lectura y la aceptación, sin reservas, de las presentes Condiciones Generales, con exclusión de cualquier otra cláusula o condición, que se tendrán por no puestas.
La no aplicación de una disposición de las presentes Condiciones Generales no constituirá una renuncia a la aplicación futura de dicha disposición por parte del vendedor.
- Las presentes Condiciones Generales de Venta entrarán en vigor el 1 de enero de 2025, anulando y sustituyendo todas las condiciones generales anteriores del vendedor.
- El vendedor se reserva el derecho incontestable de modificar las presentes Condiciones Generales de Venta en cualquier momento, notificándolo por escrito al cliente.

2. OFERTA/PEDIDO/CONFIRMACIÓN DE PEDIDO

- Con la aceptación de la oferta y/o la confirmación de pedido (según las modalidades que figuran en ella), se crea a todos los efectos un contrato de compraventa conforme a las presentes Condiciones Generales de Venta.
- Las ofertas son libres y sin compromiso de pedido.
- Los presupuestos son válidos durante 30 días a partir de su fecha de emisión, salvo que en ellos se indique lo contrario.
- Los precios son netos de IVA y excluyen los derechos de aduana, los gastos de seguro y los gastos de transporte.
- Los pedidos están sujetos a la aprobación del vendedor.
El importe mínimo del pedido es de 100 euros netos de mercancías (excluidos los gastos de transporte, seguro y embalaje).
- El embalaje estándar es gratuito. Cualquier solicitud de embalaje especial correrá a cargo del cliente. Para conocer las condiciones, los costes y los detalles específicos, consulte el documento titulado «Carta de servicios» disponible en el servicio de atención al cliente del vendedor y en el portal del cliente.
- El cliente deberá enviar el pedido a través del portal del cliente a la dirección <https://professionalsambonet.it> o por escrito por correo electrónico, indicando lo siguiente: la cantidad y el tipo de productos solicitados; el lugar de entrega y facturación.
- El cliente toma nota de que la oferta/confirmación de pedido se considerará aceptada en el momento de su recepción, sin perjuicio de cualquier notificación efectuada antes del día de la recepción de la misma.
- Las promociones de productos realizadas por el vendedor se rigen por condiciones específicas, comunicadas al cliente a través de los canales apropiados, y están sujetas a limitaciones temporales que no serán válidas ni aplicables más allá de su fecha de validez.

3. PEDIDOS DE PRODUCTOS PERSONALIZADOS

- Todos los artículos que difieran de los que figuran en la lista de precios/catálogo se considerarán «personalizados».
- El vendedor está capacitado para fabricar productos personalizados a petición del cliente, previo estudio por parte de su Centro de Estilo, bajo las siguientes condiciones:
 - El vendedor facilitará al cliente una ficha de diseño indicando todos los parámetros necesarios (diseño, posición, dimensiones, etc.) y sólo procederá al suministro una vez recibida la misma firmada para su aceptación;
 - posible envío de una muestra, previa aprobación de la correspondiente hoja de planos, del presupuesto y el pago del anticipo;
 - inicio de la producción tras la recepción por parte del vendedor del anticipo equivalente al 50% del importe total del pedido;
 - acuerdo sobre la Fecha de Entrega tras la aprobación del diseño ejecutivo y/o de la muestra;
 - facultad del vendedor de aplicar, para cada artículo individual, una tolerancia de +/-10% para los productos de los catálogos/listas de precios Sambonet, Paderno, Arthur Krupp y Rosenthal y del +/-2% para los productos del catálogo/lista de precios Ercuis, redondeado a la unidad superior, en el envío de las cantidades pedidas;
 - Los costes de la preparación personalizada del pedido (como etiquetado, empaquetado, embalaje, paletizado y/o cualquier otra solicitud fuera estándar) correrán a cargo del cliente;
 - para los productos de la marca Rosenthal, la cantidad mínima de pedido para la primera entrega con modelos o diseños personalizados es de 120 unidades por artículo (para cualquier nuevo pedido, la cantidad mínima es de 120 unidades);
 - pago del saldo del pedido antes de la entrega.
- Los pedidos de productos personalizados se consideran confirmados desde el momento en que se firma el pedido y/o el presupuesto y no pueden cancelarse.
- Los productos personalizados no podrán devolverse para su cambio o reembolso, salvo en caso de defecto de fabricación reconocido por el control de calidad del vendedor.

4. PEDIDOS DE PRODUCTOS PERSONALIZADOS DE LA MARCA SAMBONET Y A MEDIDA

- Los costes indicados a continuación deben entenderse como fijos.
- Borde dentado de las hojas de los cuchillos de fruta: cuando no se suministre de serie, con un cargo de 0,65 euros por pieza.
- Grabado con Pantógrafo/Láser:
 - coste del equipo: € 70,00;
 - coste del grabado: cubertería 0,50€ por pieza - vajilla, grabado cuando sea posible, 1,00€ por pieza;
 - cantidades mínimas: cubertería 100 piezas por artículo - vajilla 10 piezas por artículo.

- Punzonado:
 - coste punzones: el primer punzón 300,00€ - los sucesivos 150,00€ cada uno;
 - coste punzonado: cubertería 0,50€ por pieza - vajilla, presupuesto a petición;
 - cantidades mínimas:
 - equipos nuevos: cubertería 1.000 piezas por artículo - cuchillos de mango hueco 800 piezas por artículo;
 - pedidos repetidos: cubertería 100 piezas por artículo - los cuchillos de mango hueco NO se pueden punzonar (solo pantógrafo o láser).
 - Tipos de grabados Tailor Made estándar:
 - en el terminal frontal: uno de los logotipos estándar, o el monograma (dos letras) usando uno de los caracteres estándar;
 - en el terminal trasero: la fecha en formato estándar, utilizando uno de los caracteres estándar.
- Coste del grabado Tailor Made:
- 20€ para grabados en el terminal frontal;
 - 20€ para grabados en el terminal trasero;
 - 40€ para grabados en el terminal delantero y en el terminal trasero.
- Pedido mínimo de compra para artículos individuales Tailor Made:
- 6 pzas. para las referencias hechas en alpaca, con múltiples de 6 pzas.;
 - 15 pzas. para todas las otras referencias, con múltiples de 12 pzas.;
- Aplicación del coste del grabado Tailor Made en un único pedido de compra:
- El único coste por cada tipo de grabado indicado en los puntos 1,2,3 independientemente del número de piezas hasta 150 pzas., más allá de 150 pzas. y en múltiples de 150 pzas. se aplicará de nuevo el coste de grabado;
 - El único coste independientemente del número de referencias - si es superior al mínimo de compra indicado en los puntos 4 y 5.

5. PRODUCTOS DE LA MARCA ERCUIS:

PLATA MACIZA, PIEZAS DORADAS Y COLECCIONES CON MATERIALES PRECIOSOS

- Los precios de venta indicados en la lista de precios se basan en la cotización del oro y la plata a 01/01/2025 y se facilitan a título meramente informativo.
- Por lo tanto, el vendedor se reserva el derecho de actualizar el precio de venta de la oferta en función de la evolución de los precios de mercado de los metales preciosos mencionados.
- Todas las ofertas relativas a metales preciosos serán válidas por un periodo de tiempo limitado a 7 días.
- Cantidad mínima de pedido: la cantidad mínima se comunicará en el momento de la oferta.

6. PAGO

- El pago de la factura deberá efectuarse dentro del plazo de pago acordado previamente entre las partes. El vendedor se reserva el derecho de solicitar el pago por adelantado o un anticipo para cualquier pedido.
- Cualquier reclamación por parte del cliente no tendrá en ningún caso el efecto de aplazar o suspender el pago.
- En caso de retraso en el pago, el cliente también será legalmente deudor, ante el vendedor, de una compensación a tanto alzado por los gastos de reclamación del pago igual a 40,00€. En caso de que los gastos de reclamación superen este importe, el vendedor tendrá derecho a reclamar una indemnización adicional. En caso de retraso en el pago, se devengarán intereses de demora al tipo previsto en el art. 5 del D. LEG. 231/2002 y enmiendas adicionales de acuerdo con el D.LEG. 192/2012, incrementado en un 8%.
- Los pagos debidos al vendedor no podrán ser suspendidos, ni ser objeto de ningún descuento o compensación sin el acuerdo escrito del vendedor.
- El cliente moroso deberá devolver, por su cuenta y riesgo, los productos impagados. En caso de que reclame los productos, el vendedor quedará liberado de la obligación de devolver los anticipos recibidos del cliente, en la medida en que su importe pueda compensarse con el importe adeudado en concepto de daños e intereses adeudados por el Cliente (por gastos de devolución o reparación).
- En caso de impago total o parcial de la factura, o si la situación financiera del cliente se deteriora, el vendedor también tendrá derecho a:
 - suspender o cancelar los pedidos y las entregas en curso;
 - exigir legalmente el pago inmediato de todas las cantidades pendientes adeudadas por el cliente en relación con otros contratos en curso;
 - retener los productos hasta el pago íntegro del precio;
 - exigir el pago por adelantado para los pedidos sucesivos;
 - exigir garantías de pago.

7. PROHIBICIÓN DE VENTA/REEXPORTACIÓN

- El cliente no venderá, exportará o reexportará, directa y/o indirectamente, a la Federación Rusa y/o para su uso en la Federación Rusa ni a Bielorrusia y/o para su uso en Bielorrusia ninguna mercancía, suministrada en virtud de estas Condiciones Generales o en relación con las mismas, que entre en el ámbito de aplicación del Reglamento (UE) n° 833/2014, del artículo 12 octies del Reglamento (UE) n° 833/2014 del Consejo y enmiendas adicionales y/o del artículo 8 del artículo 8 del Reglamento (CE) n° 765/2006 y enmiendas adicionales, así como cualquier normativa diferente y/o adicional que pueda dictarse al respecto.
- El cliente se compromete a hacer todo lo posible para garantizar que el propósito del apartado 7.1 no se vea frustrado por terceros, que ocupen una posición sucesiva, en la cadena comercial, incluidos los revededores.
- Cualquier incumplimiento de lo dispuesto en los apartados 7.1 y 7.2 constituirá un incumplimiento grave de un elemento esencial de las presentes Condiciones Generales y del contrato celebrado en virtud de las mismas, y el vendedor tendrá derecho a adoptar las medidas apropiadas, incluidas, entre otras, a título enunciativo y no limitativo: (i) la resolución del contrato; y/o (ii) la aplicación de una sanción equivalente al 15% del valor total de dicho contrato o del precio de la mercancía exportada, si éste fuera superior; (iii) la denuncia de las infracciones a las autoridades competentes. En cualquier caso, ello se entenderá sin perjuicio de mayores daños y perjuicios sufridos por el vendedor (incluyendo, a título enunciativo y no limitativo, los derivados de las sanciones que se pudieran imponer al vendedor como consecuencia del citado incumplimiento).
- El cliente informará al vendedor inmediatamente por escrito de cualquier problema en la aplicación de los apartados 7.1 y 7.2, incluyendo cualquier actividad relevante de terceros que pudiera frustrar el propósito del apartado 7.1. El cliente pondrá a disposición del vendedor la información relativa al cumplimiento de las obligaciones previstas en los apartados 7.1 y 7.2 en un plazo de dos (2) semanas a partir de la mera solicitud por escrito de dicha información.

8. RESERVA DE DOMINIO

- Todos los productos vendidos están sujetos a reserva de dominio: las mercancías suministradas siguen siendo propiedad del vendedor hasta el pago íntegro de la factura por parte del cliente.
- La transferencia de propiedad está sujeta al pago íntegro del precio correspondiente por parte del cliente en la fecha de vencimiento acordada, sin perjuicio de la transferencia de riesgos en la fecha de entrega.
- A partir de la entrega de los productos, los riesgos correrán a cargo del cliente, sin perjuicio de la reserva de dominio. El cliente se compromete a asegurar los productos contra todos los riesgos que puedan incurrir o causar a partir de su entrega.

9. ENTREGA DE LOS PRODUCTOS Y FUERZA MAYOR

- Salvo acuerdo en contrario, los incoterms son FCA Orfengo. El transporte se realiza por cuenta y riesgo del cliente. Todos los gastos y cargas de cualquier naturaleza relacionados con el transporte correrán a cargo del cliente.
- En el caso de ventas efectuadas con devoluciones EXW y FCA, el cliente se compromete a proporcionar al vendedor, en el plazo de 90 días a partir de la fecha de la factura de venta (D.Leg. 87/2024 - D.Leg. 471/97) todas las pruebas necesarias de que la mercancía ha salido del territorio aduanero italiano y ha sido entregada en el país extranjero de destino. Si no se cumplen los plazos mencionados, el vendedor cargará el IVA al tipo italiano aplicable en un plazo de 30 días a partir de los 90.
- Los plazos de entrega se indican con la mayor precisión posible, pero dependen de las condiciones de aprovisionamiento y transporte del vendedor. El vendedor se compromete a actuar con la máxima diligencia para cumplir los plazos de entrega.
- El incumplimiento de los plazos de entrega no dará lugar en ningún caso a responsabilidad por parte del vendedor, ni conllevará el pago de sanciones, intereses o será objeto de reclamación por daños y perjuicios. Además, en estos casos, no procederá la suspensión o anulación de los pedidos en curso. En cualquier caso, la entrega dentro de los plazos sólo podrá realizarse si el cliente ha cumplido puntualmente todas sus obligaciones con el vendedor.

- 9.5. El vendedor no será responsable si el retraso o incumplimiento de las obligaciones contractuales se debe a Fuerza Mayor, siempre que pruebe: a) que dicho impedimento está fuera de su control razonable; b) que no podía preverse razonablemente en el momento de la celebración del contrato; c) que los efectos del impedimento no podían evitarse o superarse razonablemente. Salvo prueba en contrario, se considerarán casos de fuerza mayor, entre otros, la guerra, los disturbios, las restricciones comerciales, los embargos, los incendios, la destrucción de equipos, las huelgas, los actos de la autoridad judicial, el cumplimiento de cualquier ley u orden gubernamental, las epidemias, las pandemias, las catástrofes naturales o los fenómenos naturales extremos.
- En tales casos, el vendedor podrá suspender el cumplimiento de sus obligaciones contractuales mediante notificación por escrito a la otra parte, y el plazo de ejecución del suministro podrá prorrogarse por un periodo igual a la duración del evento. Salvo que se acuerde otra cosa por escrito, una vez transcurrido inútilmente el plazo de suspensión, el contrato se considerará resuelto sin más avisos.
- 9.6. El vendedor también podrá rescindir el contrato si la ejecución de la prestación se hace objetivamente demasiado onerosa debido a una circunstancia imprevisible y ajena a su voluntad.
- 9.7. Cualquier modificación del pedido dará lugar a la consiguiente modificación de los plazos.
- 9.8. Los pedidos podrán entregarse en varios paquetes y/o varias entregas. Asimismo, se acuerda entre las partes que si el cliente no toma posesión de los productos pedidos en las condiciones aceptadas anteriormente, el vendedor facturará al cliente:
- gastos de almacenaje equivalentes al 5% del importe del pedido, impuestos excluidos, por mes de retraso, siendo exigible cada mes ya iniciado;
 - cualquier otro gasto de transporte correrá a cargo del cliente.

10. CONDICIONES DE ENTREGA DE LOS PRODUCTOS DE LAS MARCAS SAMBONET/PADERNO/ARTHUR KRUPP/ROSENTHAL

Los productos presentes en los catálogos Sambonet/Paderno/Arthur Krupp/Rosenthal se entregaran, con los portes pagados por el vendedor desde el domicilio del cliente, a través de una empresa de transporte elegida por vendedor, en las condiciones indicadas en la tabla siguiente.

Para el resto de catálogos/marcas, sin embargo, se aplica la condición del apartado 9.1.

| GRUPO | PAÍSES | PORTES PAGADOS CON VALOR NETO MERCANCÍA | Gastos de gestión pedido, para pedidos inferiores a los Portes Pagados ** |
|-------|--|---|---|
| A | Italia, Alemania, Austria, Francia, Países Bajos, Bélgica, Luxemburgo | 500€ | 20€ |
| B | España, Portugal, Polonia, República Checa, Eslovaquia, Hungría, Rumanía, Eslovenia, Croacia, Bulgaria, Noruega, Andorra, Reino Unido, Irlanda del Norte, Suecia | 800€ | 35€ |
| C | Grecia, Irlanda, Letonia, Lituania, Estonia, Dinamarca, Finlandia | 1.200€ | 60€ |

** Los gastos de gestión del pedido se entiende por cada pedido realizado por el cliente y se cargarán en la factura de forma acumulativa.

11. DEVOLUCIONES/RECLAMACIONES

- 11.1. Las mercancías deben comprobarse en el momento de su recepción.
- 11.2. En caso de bultos defectuosos/dañados, el cliente se compromete:
- a formular reservas claras y precisas en el albarán de entrega en caso de pérdida o daño constatado en los productos;
 - a constatar y escribir estas reservas en presencia del transportista;
 - indicar claramente la naturaleza de los productos y el número de piezas faltantes o defectuosas.
 - confirmar sus reservas al vendedor por escrito, por correo electrónico, en un plazo de 48 horas.
- En su defecto, el cliente perderá el derecho a interponer cualquier recurso contra el vendedor en caso de pérdida o daño resultante del transporte.
- Las fórmulas «bajo reserva de desembalaje» o «bajo reserva de otra verificación» no se admiten y no tienen valor.
- 11.3. Las reclamaciones se aceptarán en un plazo de 15 días a partir de la fecha de la factura, término último no negociable, bajo las siguientes condiciones:
- la comunicación de reclamación / solicitud de devolución de la mercancía debe realizarse a través del procedimiento guiado en www.professional.sambonet.it en el área de usuario;
 - la mercancía debe devolverse con los portes pagados hasta nuestra fábrica;
 - En caso de responsabilidad del cliente, el vendedor cargará el 15% del precio neto, con un mínimo de 25,00€, en concepto de gastos de gestión;
 - en caso de responsabilidad comprobada por parte del vendedor, la mercancía se cambiará y se devolverá al cliente con los portes pagados;
 - en el caso de productos devueltos para su reparación fuera de garantía, los gastos de envío y devolución correrán a cargo del cliente;
 - las devoluciones serán objeto de un control cuantitativo y cualitativo, y los artículos faltantes o deteriorados quedarán a cargo del cliente;
 - no se aceptarán devoluciones de artículos especiales (que no figuren en el catálogo), grabados Tailor Made, con otras personalizaciones o fuera de producción.
- 11.4. El producto sólo podrá devolverse con el justificante de compra del vendedor. Los productos deben devolverse en su embalaje original en un plazo de 8 días a partir del acuerdo por escrito del vendedor.

12. GARANTÍAS - LÍMITES DE RESPONSABILIDAD - SEGURIDAD DEL PRODUCTO

- 12.1. El vendedor está asegurado de acuerdo con su calidad de fabricante de productos. La responsabilidad del vendedor se limita a la sustitución de los productos reconocidos como defectuosos, siempre que no hayan sido modificados, con exclusión de cualquier otra indemnización.
- 12.2. El vendedor no ofrece ninguna garantía contra las consecuencias de posibles condiciones de almacenamiento inadecuadas.
- 12.3. El vendedor no ofrece ninguna garantía contra los daños resultantes de un uso inadecuado o de un uso en condiciones inadecuadas o no conformes a las instrucciones de uso. El vendedor no será responsable en ningún caso ante los clientes, sus agentes, empleados, sucesores o causahabientes, de cualquier daño indirecto o inmaterial de cualquier naturaleza, incluyendo, y sin limitación, las pérdidas, los costes, los daños, las pérdidas de ingresos o beneficios, sufridos por el cliente o cualquier tercero en el contexto de sus obligaciones contractuales.
- 12.4. La responsabilidad total y acumulada del vendedor en la ejecución del Contrato no podrá superar en ningún caso el diez por ciento (10%) del importe del pedido. Las fotografías de los productos que figuran en el catálogo no tienen valor contractual.
- 12.5. Las medidas, las características y las ilustraciones de los productos son indicativas y están sujetas a cambios sin previo aviso si las necesidades técnicas y de producción así lo requieren. Dado que la producción es artesanal, puede haber ligeras diferencias entre los distintos lotes de un mismo producto.
- 12.6. La mercancía está destinada a ser comercializada en el país en el que el cliente tiene su sede. Si la mercancía se comercializa en un país diferente, será responsabilidad del cliente comprobar la normativa aplicable en dicho país, incluida la normativa de importación, así como el riesgo de reclamaciones de terceros por cualquier motivo, entendiéndose que el vendedor será eximido de cualquier responsabilidad y mantenido indemne por el cliente por cualquier daño causado por la venta de la mercancía en ese país diferente.
- 12.7. De conformidad con el Reglamento (UE) 2023/988 relativo a la seguridad general de los productos, el cliente podrá ponerse en contacto con el vendedor en la siguiente dirección de correo electrónico product.safety@sambonet.it y encontrar más información sobre los productos afectados por el citado Reglamento mediante los Códigos QR específicos:

PRODUCTOS MARCA PADERNO



PRODUCTOS MARCA SAMBONET



13. PROPIEDAD INTELECTUAL

- 13.1. El vendedor tiene la propiedad exclusiva de las marcas, dibujos, borradores, planos de modelos y más generalmente de todos los documentos de cualquier naturaleza emitidos o enviados por el vendedor al cliente.
- 13.2. La venta de los productos no implica ninguna cesión de propiedad intelectual a favor del cliente. Los derechos de propiedad intelectual, registrados o no, siguen siendo plena y entera propiedad del vendedor.
- El vendedor se reserva el derecho de emprender acciones legales en caso de violación de las disposiciones del presente capítulo.
- 13.3. Queda por tanto expresamente prohibida cualquier reproducción, imitación de estas marcas y/o de cualquier otro signo distintivo idéntico o similar, a título de marca, nombre de dominio o para cualquier otro uso. Del mismo modo, los productos, diseños, borradores, planos no podrán ser ejecutados ni reproducidos, ni representados sin la autorización previa por escrito del vendedor, ni ser objeto de ninguna reivindicación de derecho de propiedad intelectual de cualquier naturaleza que sea.
- 13.4. Los documentos publicitarios relativos a los productos y a la marca sólo podrán ser utilizados por el cliente con el acuerdo previo expreso y por escrito. El vendedor no podrá en ningún caso ser considerado responsable del origen de los productos copiados y vendidos bajo su marca, en particular en Internet, que resulten ser una infracción de sus derechos de propiedad industrial e intelectual por parte de un tercero.
- 13.5. El cliente autoriza expresamente al vendedor a indicar que interviene en nombre del cliente y/o que el cliente utiliza los productos del vendedor y a citar su nombre como referencia en sus documentos comerciales, en su sitio web y en cualquier otro soporte de comunicación existente o futuro.
- 13.6. La naturaleza de los servicios realizados para el cliente y el tipo de producto del vendedor utilizado por el cliente, no constituyen información confidencial.

14. DATOS PERSONALES

- 14.1. La venta de productos por parte del vendedor requiere la recopilación de cierta cantidad de información personal relativa al cliente, necesaria para la correcta administración de los pedidos y el cumplimiento de las obligaciones contractuales del vendedor.
- 14.2. Los datos personales facilitados por el cliente serán tratados de conformidad con el Reglamento UE n° 2016/679 y del D. Leg. n° 196/2003. Estos datos están sujetos a tratamiento informático y se conservan en condiciones seguras, de acuerdo con los medios tecnológicos actuales, de conformidad con las disposiciones del RGPD. El encargado del tratamiento es el vendedor (información de contacto a continuación). Los datos se conservan durante un periodo razonable necesario para la correcta administración de los pedidos. Los datos personales recogidos no están sujetos a ninguna transferencia al extranjero y pueden, sin embargo, ser transferidos a un cesionario de negocios y/o comprador como parte de una reestructuración.
- 14.3. El cliente dispone de un derecho de acceso, modificación, rectificación, supresión de los datos que le conciernen, que podrá ejercer ante el vendedor por correo electrónico privacy@sambonet.it o por correo ordinario.

15. CONFIDENCIALIDAD

- 15.1. El cliente considerará estrictamente confidencial y se compromete a no divulgar cualquier información de la que pueda tener conocimiento durante la ejecución del Contrato o de un pedido. Esta cláusula seguirá siendo válida mientras la información confidencial no sea divulgada públicamente por parte del vendedor.

16. DERECHO APLICABLE - SOLUCIÓN DE CONTROVERSIAS

- 16.1. Para cualquier disputa o controversia, se aplicará la ley italiana y el Tribunal de Novara tendrá competencia exclusiva.
- 16.2. En el caso de clientes extranjeros, la ley italiana se aplica no sólo a las controversias, sino a toda la relación contractual, con exclusión de la aplicación de la Convención de Viena sobre los Contratos de Compraventa de Mercaderías.

CREDITS

PHOTO

Riccardo Bianchi
Felice Scoccimarro

LOCATIONS

Cucine Nervi - Gattinara (NO)

COVER

Paolo Oberti - Sous Chef di Cucine Nervi



ARCTURUS GROUP

© COPYRIGHT

- Ogni riproduzione anche parziale del presente catalogo è vietata se non espressamente autorizzata per iscritto da Sambonet Paderno Industrie S.p.A.
- This catalogue may not be reproduced in whole or in part unless specific prior written authorization of Sambonet Paderno Industrie S.p.A.
- Die Vervielfältigung dieses Katalogs -auch wenn partial- ohne unsere ausdrückliche schriftliche Erlaubnis ist untersagt.
- Toute reproduction ou reproduction partielle de ce catalogue est interdite sauf expressément autorisée par Sambonet Paderno Industrie S.p.A.
- Queda prohibida la reproducción total o parcial de este catálogo sin autorización de forma expresa y por escrito de Sambonet Paderno Industrie S.p.A.

NOTE - NOTES

- Le misure, caratteristiche ed illustrazioni dei prodotti sono indicative e soggette a variazioni senza preavviso qualora esigenze tecnico produttive lo richiedessero.
- The pictures illustrated and data are representatives. We reserve the right to alter at any time the specifications stated without notice, whenever technical requirements shall so demand.
- Fotos und Abmessungen sind nur als information zu verstehen. Wir behalten uns das Recht vor, die angegebenen Spezifikationen jederzeit zu ändern, sofern es aus produktionstechnischen Gründen erforderlich ist.
- Les photos et dimensions indiquées sont indicatives. Nous nous réservons le droit de modifier à tout moment les spécifications techniques, si la situation l'exige.
- Fotos, datos y medidas que aparecen en este catálogo son indicativos y susceptibles, sin previo aviso, de modificación por exigencias técnicas o de producción.

PADERNO®

WORLD CUISINE



www.paderno.it

SAMBONET PADERNO INDUSTRIE S.P.A.

Via Giovanni Coppo, 1C - 28060 Orfengo (NO) - Italy

Ph. +39 0321 1916 601

Fax +39 0321 1916 890

horeca@paderno.it

www.paderno.it

ROSENTHAL SAMBONET USA LTD.

685 Route 10 - Randolph NJ 07869 - USA

Ph. +1 201 804 8000

Fax +1 201 842 9195

info@rosenthalusa.com

www.rosenthal-hotel-restaurant.com



ARCTURUS GROUP

XE2281 - Ed. 01/2025

9179888087108

