

# FRILICH

THE ORIGINAL





### Verehrter Kunde,

wir sorgen für den unvergleichlichen und stimmungsvollen Auftritt Ihres Buffets: Die außerordentlich variantenreiche Produktvielfalt an Präsentations- und Spendersystemen, die wir in unserem Frilich Katalog Nr. 10 vorstellen, zeichnet sich durch individuelle Design-Linien aus, die sich jedem Ambiente ohne weiteres anpassen.

Auch eine Vielzahl von Ausstattungsdetails mit dem bewährten, hohen Anspruch an Qualität und Funktion wird Sie überzeugen. FRILICH setzt weiterhin auf den Produktionsstandort Deutschland, um eine lückenlose Qualitätssicherung zu gewährleisten.

Seit nunmehr über 35 Jahren entwickeln und optimieren wir unsere Ideen für den täglichen praktischen Einsatz im permanenten Dialog mit unseren Kunden. Diese Kundennähe hat das familiengeführte Unternehmen FRILICH zum Marktführer und Marktmacher rund ums Buffet gemacht. Wir beraten und unterstützen Sie sehr gern bei der kreativen Buffetgestaltung – rufen Sie uns an!

### Dear customer,

*We provide for an incomparable and atmospheric appearance of your buffet: The exceedingly versatile product variety of presentation- and dispensing systems, which we introduce in our Frilich catalogue No. 10, stands out through individual designs suitable to easily adapt to any ambiance.*

*A multitude of equipment details with established high quality and functionality standards will convince you. Frilich furthermore emphasizes on the production site Germany to guarantee a consistent quality assurance.*

*Since more than 35 years we develop and optimize our ideas for a daily practical use in permanent dialogue with our clients. This customer proximity turned the family-run business FRILICH into a market leader and market shaper for buffet ware. We gladly advise and support you in creating your individual buffet arrangement – just call us!*

  
Stefan Gömmer  
Geschäftsführer  
Managing Director

  
Michael Gömmer  
Geschäftsführer  
Managing Director



## Kontakt · Contact

### Vertrieb National / Sales Germany



**Erika Heer**  
Fon +49 (0) 64 08 - 90 80 -15  
Fax +49 (0) 64 08 - 90 80 -11  
e.heer@frilich.de



**Gaby Schell**  
Fon +49 (0) 64 08 - 90 80 -25  
Fax +49 (0) 64 08 - 90 80 -11  
g.schell@frilich.de



**Martin Haese**  
Fon +49 (0) 64 08 - 90 80 -32  
Fax +49 (0) 64 08 - 90 80 -11  
m.haese@frilich.de



**Ella Flemmer**  
Fon +49 (0) 64 08 - 90 80 -34  
Fax +49 (0) 64 08 - 90 80 -11  
e.flemmer@frilich.de



**Vera Steinborn**  
Fon +49 (0) 64 08 - 90 80 -40  
Fax +49 (0) 64 08 - 90 80 -11  
v.steinborn@frilich.de

### Vertrieb International / Sales Worldwide



**Hanna Ritz**  
Fon +49 (0) 64 08 - 90 80 -35  
Fax +49 (0) 64 08 - 90 80 -44  
h.ritz@frilich.de



**Sven Schneider**  
Fon +49 (0) 64 08 - 90 80 -20  
Fax +49 (0) 64 08 - 90 80 -44  
s.schneider@frilich.de



**Benjamin Lock**  
Fon +49 (0) 64 08 - 90 80 -17  
Fax +49 (0) 64 08 - 90 80 -44  
b.lock@frilich.de



**Ulrike Wagner**  
Fon +49 (0) 64 08 - 90 80 -28  
Fax +49 (0) 64 08 - 90 80 -44  
u.wagner@frilich.de

### Außendienst / Field Staff Germany



**Stefan Fleischer**  
Wilhelm-Wolff-Straße 10  
09117 Chemnitz  
Fon +49 (0) 3 71 - 2 62 26 35  
Fax +49 (0) 3 71 - 2 62 26 34  
s.fleischer@frilich.de  
Vertretungsgebiet:  
Sachsen, Thüringen,  
Sachsen-Anhalt,  
Berlin, Brandenburg,  
Mecklenburg-Vorpommern



**Thomas Seifert**  
Beim Kramer 6  
86923 Finning  
Fon +49 (0) 88 06 - 95 87 70  
Fax +49 (0) 88 06 - 95 87 71  
t.seifert@frilich.de  
Vertretungsgebiet:  
Bayern



**Norbert Hense**  
Landwehrstraße 1 a  
59590 Geseke-Langeneicke  
Fon +49 (0) 29 42 - 98 77 29  
Fax +49 (0) 29 42 - 98 77 32  
n.hense@frilich.de  
Vertretungsgebiet:  
Westfalen (NRW),  
Niedersachsen



**René Fröhlich**  
Friedrichstraße 30  
61476 Kronberg  
Fon +49 (0) 61 73 - 96 66 782  
Fax +49 (0) 32 22 - 15 31 988  
Mobil +49 (0) 170 - 630 58 24  
r.froehlich@frilich.de  
Vertretungsgebiet:  
Hessen



**Alfred Kiefer**  
Hasseler Weg 15  
66459 Kirkel  
Fon +49 (0) 68 49 - 18 12 53  
Fax +49 (0) 68 49 - 80 34  
Mobil +49 (0) 1 76 - 32 79 32 65  
a.kiefer@frilich.de  
Vertretungsgebiet:  
Saarland, Rheinland-Pfalz,  
Baden-Württemberg, Hessen



**Oliver Skokann**  
Löhfeld 26  
21423 Winsen/Luhe  
Fon +49 (0) 41 71 - 6 92 33 50  
Fax +49 (0) 41 71 - 6 92 33 51  
o.skokann@frilich.de  
Vertretungsgebiet:  
Schleswig-Holstein, Hamburg,  
Bremen, Niedersachsen



**Ludger Petkens**  
Winternam 145  
47647 Kerken  
Fon +49 (0) 28 31 - 9 77 25 61  
Fax +49 (0) 28 31 - 9 77 25 62  
l.petkens@frilich.de  
Vertretungsgebiet:  
Nordrhein-Westfalen,  
Rheinland-Pfalz



**Pressebüro**  
Elke Baumstark  
Postfach 12 19  
82168 Puchheim  
Büroanschrift:  
Sommerstraße 1  
82178 Puchheim  
Fon +49 (0) 89 - 80 07 18 08  
Fax +49 (0) 89 - 80 90 88 19  
Baumstark-Foerstl@t-online.de



**PAMPA BAY Tisch- und Buffetware**  
Mit Titan beschichtetes Glas und Porzellan,  
nicht nur ganz exklusiv sondern auch robust!

**PAMPA BAY Table and Buffet Ware**  
With titanium coated glass and porcelain,  
not only very exclusive but also unexpected  
durable!



**BOX 'Bread' und 'Bits and Pieces'**  
Backwaren und kleine Utensilien für die  
Gastronomie in der Schublade versteckt  
aber doch offen und hygienisch präsentiert.

**BOX 'Bread' and 'Bits and Pieces'**  
Baked goods and small utensils for the  
catering hidden in the drawer but still  
openly and hygienic presented.



**RAISER Buffet System 'OAK'**  
Flexibel und platzsparend bieten die hoch-  
wertig gefertigten Buffetmodule aus Eiche  
der gewohnten FRILICH Funktionalität ein  
neues, anspruchvolles Gesicht.

**RAISER Buffet System, 'OAK',**  
Flexible and space-saving, the high-quality  
oak buffet modules of the familiar FRILICH  
functionality offer a new, ambitious look.



**ACE OF VASE Getränkespender**  
Auch große Getränkevolumen können mit  
'ACE OF VASE' attraktiv auf dem Buffet  
präsentiert werden.

**ACE OF VASE Beverage Dispenser**  
Also large volumes of beverages can be  
presented attractively with 'ACE OF VASE'  
on the buffet.



**RAISER Brain Food Box**  
Snacks und Fingerfood bei der Kaffeepause, in der Hotel Lobby oder  
in Lounges edel und mit System präsentiert.

**RAISER Brain Food Box**  
A noble and organized presentation of snacks and finger food for the  
coffee break, in the hotel lobby or in lounges.

Alles für's Buffet / All for Buffet

|  |                  |
|--|------------------|
| Ideen für Buffet Stationen                           | Seite 4          |
| <i>Ideas for Buffet Stations</i>                     | <i>Page 4</i>    |
| <b>PAMPA BAY</b>                                     | <b>Seite 13</b>  |
| <i>PAMPA BAY</i>                                     | <i>Page 13</i>   |
| <b>Buffets für Getränke</b>                          | <b>Seite 21</b>  |
| <i>Beverage Buffets</i>                              | <i>Page 21</i>   |
| <b>Buffets für Müsli, Konfi &amp; Honig</b>          | <b>Seite 39</b>  |
| <i>Muesli, Jam &amp; Honey Buffets</i>               | <i>Page 39</i>   |
| <b>Buffets für Wurst, Käse, Salate &amp; Joghurt</b> | <b>Seite 51</b>  |
| <i>Cold Cuts, Salad &amp; Yoghurt</i>                | <i>Page 51</i>   |
| <b>Schälchenhalter &amp; Hygieneschutz</b>           | <b>Seite 77</b>  |
| <i>Bowl Holder &amp; Hygienic Cover</i>              | <i>Page 77</i>   |
| <b>Buffets für Brot &amp; Utensilien</b>             | <b>Seite 83</b>  |
| <i>Bread Buffets &amp; Utensils</i>                  | <i>Page 83</i>   |
| <b>Gastro (Displays &amp; Coffee Shop)</b>           | <b>Seite 97</b>  |
| <i>Gastro (Displays &amp; Coffee Shop)</i>           | <i>Page 97</i>   |
| <b>Accessoires</b>                                   | <b>Seite 102</b> |
| <i>Accessoires</i>                                   | <i>Page 102</i>  |
| <b>Ersatzteile</b>                                   | <b>Seite 106</b> |
| <i>Spare Parts</i>                                   | <i>Page 106</i>  |
| <b>FRILICH Buffetplaner</b>                          | <b>Seite 114</b> |
| <i>FRILICH Buffet Planer</i>                         | <i>Page 114</i>  |
| <b>Artikelliste</b>                                  | <b>Seite 116</b> |
| <i>List of Articles</i>                              | <i>Page 116</i>  |
| <b>FRILICH Edelstahlhahn</b>                         | <b>Seite 119</b> |
| <i>FRILICH Stainless Steel Faucet</i>                | <i>Page 119</i>  |
| <b>AGB</b>   | <b>Seite 120</b> |
| <i>Standard Terms</i>                                | <i>Page 120</i>  |





### CARAFINE, PICKNICK & BUGAMBILIA

- |   |   |
|---|---|
| 1 LSC 070 H 001 (Seite/page 30)             | 5 NFC 030 B 302 (Seite/page 52)           |
| 2 LB 609 (Seite/page 30)                    | 6 NFC 000 B 402 (Seite/page 52)           |
| 3 G05.010.0121WW (Bugambilia, Seite/page 6) | 7 3SH010, 3SH014, 3SH012 (Seite/page 103) |
| 4 G06.006.0001 (Bugambilia, Seite/page 8)   | 8 3PO054, 3ZU038 (Seite/page 105)         |



### RAISER 'NATURE'

- |                                 |                                |
|---------------------------------|--------------------------------|
| 1 RSC 050 H 006 (Seite/page 24) | 4 F09.200.0000 (Seite/page 26) |
| 2 RSC 080 H 006 (Seite/page 24) | 5 RB 648 H 002 (Seite/page 84) |
| 3 F10.201.0000 (Seite/page 27)  | 6 3KO020 (Seite/page 106)      |



### CONNECT, CARAFINE & PAMPA BAY

- |                                 |                                |
|---------------------------------|--------------------------------|
| 1 ESC 040 E 101 (Seite/page 33) | 5 P01.007.0007 (Seite/page 17) |
| 2 ESC 030 E 101 (Seite/page 33) | 6 P01.007.0008 (Seite/page 17) |
| 3 ESC 060 E 003 (Seite/page 28) | 7 P01.007.0001 (Seite/page 16) |
| 4 P01.007.0003 (Seite/page 16)  | 8 3SC330E (Seite/page 103)     |



### ELEGANCE & PAMPA BAY

- |                                 |                                |
|---------------------------------|--------------------------------|
| 1 P01.008.0000 (Seite/page 18)  | 4 P01.008.0005 (Seite/page 18) |
| 2 EFC 000 G 405 (Seite/page 73) | 5 ESC 025 G (Seite/page 35)    |
| 3 P01.008.0002 (Seite/page 18)  | 6 3SC330G (Seite/page 103)     |



PURE NATURE & CARAFINE

- |   |                                   |
|---|-----------------------------------|
| 1 RCO 105 X 002 (Seite/page 48)         | 5 RFC 020 X 002 (Seite/page 76)   |
| 2 RCO 045 X 002 (Seite/page 48)         | 6 RFC 020 X (Seite/page 76)       |
| 3 RCO 015 X 002 (Seite/page 48)         | 7 3SH011 (Seite/page 103)         |
| 4 LSC 030 H 001, 5SC002 (Seite/page 22) | 8 3PO054, 3ZU038 (Seite/page 105) |



ELEGANCE & CONNECT

- |                                 |                                 |
|---------------------------------|---------------------------------|
| 1 EMC 030 E (Seite/page 34)     | 5 ETO 015 E 100 (Seite/page 40) |
| 2 ETO 250 E 100 (Seite/page 41) | 6 ETO 006 E 101 (Seite/page 40) |
| 3 ETO 350 E 100 (Seite/page 41) | 7 3SH011 (Seite/page 103)       |
| 4 ETO 200 E 100 (Seite/page 40) | 8 3PO054 (Seite/page 105)       |



ELEGANCE & PAMPA BAY

- |                                 |                                 |
|---------------------------------|---------------------------------|
| 1 P01.006.0001 (Seite/page 20)  | 5 P01.006.0000 (Seite/page 20)  |
| 2 EB 616 E 003 (Seite/page 78)  | 6 EMC 050 E 007 (Seite/page 37) |
| 3 ECO 018 E (Seite/page 42)     | 7 3SH011 (Seite/page 103)       |
| 4 ETO 045 E 002 (Seite/page 42) |                                 |



RAISER 'BLACK STEEL' & CONNECT

- |                                |   |
|--------------------------------|---|
| 1 F07.101.0003 (Seite/page 49) | 4 3PO054, 3ZU038 (Seite/page 105)         |
| 2 F08.102.0000 (Seite/page 48) | 5 3SH010, 3SH011, 3SH012 (Seite/page 103) |
| 3 3BE007 (Seite/page 28)       |   |
| EB 801 E (Seite/page 32)       |   |



PICKNICK & RAISER 'BLACK STEEL'

- 1 NFC 000 B 403, NB 001 E (Seite/page 52)
- 2 NFC 030 B 303, NB 004 E (Seite/page 52)
- 3 F01.102.0000 (Seite/page 57)
- 4 F01.101.0000 (Seite/page 57)
- 5 F02.101.0000 (Seite/page 59)
- 6 F05.101.0004, EB 578 E (Seite/page 65)
- 7 F05.102.0001, EB 578 E (Seite/page 65)
- 8 3PO054, 3ZU038 (Seite/page 105)



PURE NATURE, UNISON & EARTH

- 1 3ST084 (Seite/page 94)
- 2 3ST082 (Seite/page 94)
- 3 EFC 000 E 019 (Seite/page 71)
- 10078 (Seite/page 70)
- 4 NFC 000 E 401, NB 001 E (Seite/page 54)
- 5 EFC 000 E 018 (Seite/page 73)
- EB 543 E (Seite/page 72)
- 6 3SH010, 3SH011, 3SH012 (Seite/page 103)



PURE NATURE & RAISER 'STAINLESS STEEL'

- 1 3ST084 (Seite/page 94)
- 2 3ST162 (Seite/page 94)
- 3 F03.002.0000 (Seite/page 61)
- 4 F01.002.0000 (Seite/page 57)
- 5 EB 710 E (Seite/page 80)



RAISER 'OAK' & BUGAMBILIA

- 1 G05.010.0122WW (Bugambilia Seite/page 6)
- 2 G06.006.0001 (Bugambilia Seite/page 8)
- 3 F01.401.0000 (Seite/page 56)
- 4 F02.400.0000 (Seite/page 58)
- 5 F03.401.0000 (Seite/page 60)
- 6 F03.400.0000 (Seite/page 60)
- 7 F04.401.0000 (Seite/page 62)
- 8 3PO054, 3ZU038 (Seite/page 105)



RAISER 'STAINLESS STEEL' & ELEGANCE

- |                                |                                 |
|--------------------------------|---------------------------------|
| 1 F13.002.0001 (Seite/page 90) | 5 F03.002.0001 (Seite/page 61)  |
| 2 F13.000.0001 (Seite/page 90) | 6 F06.001.0001 (Seite/page 67)  |
| 3 F14.001.0001 (Seite/page 91) | 7 ETO 000 E 001 (Seite/page 95) |
| 4 F03.001.0001 (Seite/page 61) |                                 |



RAISER 'STAINLESS STEEL' & ELEGANCE

- |  |                                 |
|--|---------------------------------|
| 1 3KO020 (Seite/page 106)                | 4 ETO 000 E 001 (Seite/page 95) |
| 2 RB 648 H 002 (Seite/page 84)           | 5 F06.201.0004 (Seite/page 66)  |
| 3 3PO110, 3PO112, 3PO113 (Seite/page 68) | 6 F06.200.0001 (Seite/page 66)  |



RAISER 'OAK' & BOX

- |                                |                                 |
|--------------------------------|---------------------------------|
| 1 BTO 070 H (Seite/page 86)    | 5 ETO 000 E 001 (Seite/page 95) |
| 2 BTO 120 H (Seite/page 86)    | 6 RB 648 H 005 (Seite/page 85)  |
| 3 F06.400.0000 (Seite/page 66) | 7 3KO020 (Seite/page 106)       |
| 4 F06.401.0000 (Seite/page 66) |                                 |





## GASTRO &amp; ELEGANCE

- ❶ ESC 050 E 023 (Seite/page 37)      ❸ DB 051, DB 054, 1ME023, 1ME022 (Seite/page 98)  
 ❷ DFO 002 A 017\* (Seite/page 100)      ❹ DB 051, DB 053, 3SA053, 1ME016, 1ME023 (Seite/page 98)



## GASTRO &amp; BOX

- ❶ BTO 014 H (Seite/page 86)      ❸ DVO 020 H (Seite/page 101)  
 ❷ BTO 006 H (Seite/page 86)      ❹ DVO 050 H (Seite/page 101)

\*Nur als Streuzuckerspender erhältlich. / Only available for granulated sugar.



## PAMPA BAY™

PAMPA BAY Produkte werden im Herzen des Pampa-Getreidegürtels in Argentinien entwickelt. Im Umfeld einer atemberaubenden Landschaft arbeiten die Designer ständig an den schönsten Formen, die von diesem Ort inspiriert werden. Pampa Bay bieten unwiderstehliche, einzigartige Designs in bester Qualität, die von den besten Handwerkern der Welt hergestellt werden. Die Hauptstadt Argentiniens, Buenos Aires, ist stark von der europäischen Kultur geprägt und wird häufig als „Paris Südamerikas“ bezeichnet. Jedes Design, das kreiert wird, spiegelt einen Teil dieser Kultur wieder, die elegant und einzigartig ist.

*Pampa Bay products are developed in the heart of the Pampa Grain Belt in Argentina. Surrounded by breathtaking scenery, our designers are constantly working on the most beautiful designs inspired by this place. PAMPA BAY offers irresistible, unique, top-quality designs made by the finest craftsmen in the world. The capital of Argentina, Buenos Aires, is strongly influenced by European culture and is often referred to as the „Paris of South America“. Every design created reflects a part of this culture that is elegant and unique.*





**'When Glass Meets Titanium' Servierschalen und -platten**  
*'When Glass Meets Titanium' Serving Bowls and Platters*



**P01.005.0000** Dessert-Glasschale mit Titanbeschichtung (blau)  
*Dessert Glass Bowl with titanium coating (blue)*

H: 44 B: 191 T: 191



**P01.005.0001** Dessert-Glasschale mit Titanbeschichtung (grün)  
*Dessert Glass Bowl with titanium coating (green)*

H: 44 B: 191 T: 191



**P01.005.0002** Dessert-Glasschale mit Titanbeschichtung (braun)  
*Dessert Glass Bowl with titanium coating (brown)*

H: 44 B: 191 T: 191



**P01.005.0003** Dessert-Glasschale mit Titanbeschichtung (Champagne)  
*Dessert Glass Bowl with titanium coating (Champagne)*

H: 44 B: 191 T: 191



**P01.005.0004** Glasschale, groß mit Titanbeschichtung (blau)  
*Oversize Glass Bowl with titanium coating (blue)*

H:102 B: 343 T: 343



**P01.005.0005** Glasschale, groß mit Titanbeschichtung (Champagne)  
*Oversize Glass Bowl with titanium coating (Champagne)*

H:102 B: 343 T: 343



**P01.005.0006** Glasschale, klein mit Titanbeschichtung (blau)  
*Small glass bowl with titanium coating (blue)*

H:76 B: 140 T: 140



**P01.005.0007** Glasschale, klein mit Titanbeschichtung (Champagne)  
*Small glass bowl with titanium coating (Champagne)*

H:76 B: 140 T: 140



**P01.005.0008** Snack-Glasschale mit Titanbeschichtung (blau)  
*Snack Glass Bowl with titanium coating (blue)*

H:64 B: 114 T: 114



**P01.005.0009** Snack-Glasschale mit Titanbeschichtung (Champagne)  
*Snack Glass Bowl with titanium coating (Champagne)*

H:64 B: 114 T: 114



**P01.005.0010** Snack-Glasschale mit Titanbeschichtung (grün)  
*Snack Glass Bowl with titanium coating (green)*

H:64 B: 114 T: 114



**P01.005.0011** Glasschale mit Titanbeschichtung (blau)  
*Glass Bowl with titanium coating (blue)*

H:64 B: 152 T: 152



**P01.005.0012** Glasschale mit Titanbeschichtung (Champagne)  
*Glass Bowl with titanium coating (Champagne)*

H:64 B: 152 T: 152



**P01.005.0013** Glasschale mit Titanbeschichtung (grün)  
*Glass Bowl with titanium coating (green)*

H:64 B: 152 T: 152

**'Verona' Servierschalen und -platten**  
*'Verona' Serving Bowls and Platters*



**P01.007.0001**  
 Servierschale (flach) mit  
 Titanbeschichtung  
*Serving bowl (flat) with  
 titanium coating*

H: 76 B: 305 T: 229



**P01.007.0002**  
 Servierschale (tief) mit  
 Titanbeschichtung  
*Serving bowl (deep) with  
 titanium coating*

H: 102 B: 368 T: 368



**P01.007.0003**  
 Ovalplatte (groß)  
 mit Titanbeschichtung  
*Large oval platter with  
 titanium coating*

H: 38 B: 470 T: 330



**P01.007.0011**  
 Servierplatte (groß)  
 mit Titanbeschichtung  
*Serving Platter (large)  
 with titanium coating*

H: 38 B: 381 T: 343



**P01.007.0000**  
 Serviertablett (rund)  
 mit Titanbeschichtung  
*Serving Platter (round)  
 with titanium coating*

H: 64 B: 356 T: 356



**P01.007.0004**  
 Salatschale (groß) mit  
 Titanbeschichtung  
*Salad bowl (large) with  
 titanium coating*

H: 114 B: 267 T: 267



**P01.007.0008**  
 Tortenplatte (rund) inkl. Fuß  
 mit Titanbeschichtung  
*Round Cake Stand incl. Foot  
 with titanium coating*

H: 127 B: 279 T: 279



**P01.007.0007**  
 Snackschale (groß) mit  
 Titanbeschichtung  
*Snack bowl (large) with  
 titanium coating*

H: 83 B: 222 T: 210



**P01.007.0005**  
 Snackschale mit  
 Titanbeschichtung  
*Cracker Tray with  
 titanium coating*

H: 38 B: 356 T: 89

**'Verona' Servierschalen und -platten**  
*'Verona' Serving Bowls and Platters*



**P01.007.0009**  
 Amuse-Gueule-Platte (rund)  
 inkl. Fuß mit Titanbeschichtung  
*Pedestal Cupcake Stand  
 incl. Foot with titanium coating*

H: 76 B: 127 T: 127

**P01.007.0010**  
 Snackschale (klein) mit  
 Titanbeschichtung  
*Snack Bowl  
 with titanium coating*

H: 51 B: 140 T: 121



**P01.007.0006**  
 Snackplatte (klein) mit  
 Titanbeschichtung  
*Round appetizer / dessert plate  
 with titanium coating*

H: 38 B: 178 T: 178

**„Monaco“ Servierschalen und -platten**  
**„Monaco“ Serving Bowls and Platters**



**P01.008.0001** Servierschale (flach) mit Titanbeschichtung  
*Serving bowl (flat) with titanium coating*

H: 76 B: 305 T: 229



**P01.008.0002**

Ovalplatte (groß) mit Titanbeschichtung  
*Large oval platter with titanium coating*

H: 38 B: 470 T: 330



**P01.008.0004** Salatschale mit Titanbeschichtung  
*Salad Bowl with titanium coating*

H: 89 B: 216 T: 216



**P01.008.0006** Snackschale (klein) mit Titanbeschichtung  
*Snack bowl with titanium coating*

H: 51 B: 121 T: 140



**P01.008.0005** Amuse-Gueule-Platte (rund) mit Titanbeschichtung  
*Pedestal cupcake stand with titanium coating*

H: 76 B: 127 T: 127



**P01.008.0003** Snackschale mit Titanbeschichtung  
*Cracker Tray with titanium coating*

H: 38 B: 356 T: 89



**„Golden Salerno“ Servierschalen und -platten**  
**„Golden Salerno“ Serving Bowls and Platters**



**P01.009.0000** Salatschale (groß) mit Titanbeschichtung  
*Salad Bowl (large) with titanium coating*

H: 127 B: 267 T: 267



**P01.009.0001** Snackschale mit Titanbeschichtung  
*Cracker Tray with titanium coating*

H: 38 B: 356 T: 89



**IT'S PORCELAIN.**

**High fired porcelain serveware. / Hoch gebranntes Porzellan.**  
**Gold and silver titanium finish. / Gold- bzw. Silberausführung mit Titanbeschichtung.**  
**Dishwasher safe. / Spülmaschinengeeignet.**  
**Stain resistant. / Beständigkeit gegen Fleckenbildung.**  
**Food safe / Lebensmittelecht.**  
**Will not scratch or lose luster. / keine Bildung von Kratzer und verliert nicht an Glanz.**  
**Tarnish free. / Läuft nicht an.**  
**Oven safe up to 350 F. / Verwendung im Backofen bis zu 175 C.**

**THE LOOK OF METAL WITH THE CONVENIENCE OF PORCELAIN.**

**„Salerno“ Servierschalen und -platten**  
**„Salerno“ Serving Bowls and Platters**



**P01.006.0000**  
 Ovalplatte (groß) mit  
 Titanbeschichtung  
*Oval platter (large) with  
 titanium coating*

H: 38 B: 470 T: 330

**P01.006.0001**  
 Salatschale (groß) mit  
 Titanbeschichtung  
*Salad bowl (large) with  
 titanium coating*

H: 114 B: 267 T: 254



**P01.006.0005**  
 Snackschale (klein) mit  
 Titanbeschichtung  
*Snack bowl (small) with  
 titanium coating*

H: 51 B: 140 T: 121



**P01.006.0002**  
 Snackschale mit  
 Titanbeschichtung  
*Cracker Tray with  
 titanium coating*

H: 38 B: 356 T: 89



**P01.006.0003**  
 Tortenplatte (rund) inkl. Fuß  
 mit Titanbeschichtung  
*White pedestal cupcake stand (round)  
 with titanium coating*

H: 127 B: 279 T: 279



**P01.006.0004**  
 Amuse-Gueule-Platte  
 inkl. Fuß mit Titanbeschichtung  
*Round cake stand with  
 titanium coating*

H: 76 B: 127 T: 127



## GETRÄNKE / BEVERAGES

FRILICH bietet ein sehr variantenreiches Programm, um Saft und Milch auf dem Buffet für jeden Geschmack, richtig in Szene zu setzen. Ob in der Karaffe oder im klassischen Dispenser, die Produktverarbeitung ist unvergleichbar, der Zapfhahn für die Dispenser ist einzigartig. Nur der Edelstahlhahn von FRILICH ist für nahezu alle Getränke einsetzbar, formschön und zugleich einfach zu reinigen.

FRILICH offers a very varied range to present juice and milk on the buffet for every taste. Whether in the carafe or in a classic dispenser, the quality of the products are incomparable, the dispensing faucet is unique. Only the stainless steel faucet by FRILICH can be used for almost all beverages, attractive and easy to clean at the same time.

**CARAFINE Getränke-Set 'Trio Timber'**  
**CARAFINE Beverage-Set 'Trio Timber'**



**'Natur'**  
 Holztragerl (natur), 3 Kunststoffeinsätze  
 sowie Halterung für Kühlakkus, 3 Kühlakkus,  
 3 Glasflaschen mit Milchmotiv (à 1,0 l)  
*Wooden Crate (nature), 3 Plastic Insets and  
 Cooling Pack Holder, 3 Cooling Packs, 3 Glass  
 Bottles with Milk Motif (1,0 l ea.)*

**LSC 030 H 001**

**Maße / Dimensions:**  
 445 410 170



**'Vintage White'**  
 Holztragerl (mit weißem Lack in 'used look'  
 bearbeitet), 3 Kunststoffeinsätze sowie Halte-  
 rung für Kühlakkus, 3 Kühlakkus, 3 Glasflaschen  
 mit Milchmotiv (à 1,0 l)  
*Wooden Crate 'Vintage White' (processed with  
 white varnish in 'used look'), 3 Plastic Insets and  
 Cooling Pack Holder, 3 Cooling Packs, 3 Glass  
 Bottles with Milk Motif (1,0 l ea.)*

**LSC 030 H 003**

**Maße / Dimensions:**  
 445 410 170



**Holztragerl 'Natur'**  
 inkl. 3 Kunststoffeinsätze  
 sowie Halterungen für Kühlakkus,  
 3 Kühlakkus  
**Wooden Crate 'Nature'**  
 incl. 3 Plastic Insets and Cooling Pack  
 Holder, 3 Cooling Packs  
**LB 607**



**Holztragerl 'Vintage White'**  
 mit weißem Lack in 'used look'  
 bearbeitet, inkl. 3 Kunststoffeinsätze  
 sowie Halterungen für Kühlakkus,  
 3 Kühlakkus  
**Wooden Crate 'Vintage White'**  
 processed with white varnish in 'used look'  
 incl. 3 Plastic Insets and Cooling Pack  
 Holder, 3 Cooling Packs  
**LB 608**



**Flasche mit Milchmotiv (1,0 l)**  
 und Silikonstopfen  
**Bottle with milk motif (1,0 l)**  
 and Silicon Plug  
**LB 506**



**Steckschild aus Holz (natur)**  
 mit individueller Beschriftung  
**Insert Wooden Label (nature)**  
 Inscription of Choice  
**SSC002**

Steckschilder mit individueller Beschriftung separat bestellen  
 Insert Label with individual Inscription of choice has to be ordered separately



Auch Karaffen und Bügelflaschen einsetzbar Seite 30  
 Also applicable for Carafes and Swing Top Bottles Page 30

**ACE OF VASE Saftkanne 'Uno'**  
**ACE OF VASE Juice Dispenser 'Uno'**



mit Kunststoffbehälter 12 Liter (PC),  
 FRILICH Zapfhahn-Adapter, Edelstahlhahn,  
 Standfuss aus Multiplexholz,  
 Edelstahldeckel für Eiswürfel-Kühlung und /oder  
 Obst-Dekoration, Kühlakku, Tropfschale  
*with plastic container 12 liters (PC),  
 FRILICH Faucet Adapter,  
 Stainless Steel Faucet,  
 Stand made of multiplex wood,  
 Stainless Steel lid for ice cube  
 Cooling and /or fruit decoration,  
 Cooling Pack, Drip Tray*

**ASC 100 H**

**Maße / Dimensions:**  
 810 330 200

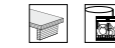

**ACE OF VASE Saftkanne 'Duo'**  
**ACE OF VASE Juice Dispenser 'Duo'**



mit Kunststoffbehältern 2x 12 Liter (PC),  
 FRILICH Zapfhahn-Adapter, Edelstahlhahn,  
 Standfuss aus Multiplexholz,  
 Edelstahldeckel für Eiswürfel-Kühlung und /oder  
 Obst-Dekoration, Kühlakku, Tropfschale  
*with plastic container 2x 12 liters (PC), FRILICH  
 Faucet Adapter, Stainless Steel Faucet, Stand  
 made of multiplex wood,  
 Stainless Steel lid for ice cube  
 Cooling and /or fruit decoration,  
 Cooling Pack, Drip Tray*

**ASC 200 H**

**Maße / Dimensions:**  
 810 530 200

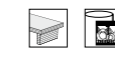

**PURE NATURE Milchkanne**  
**PURE NATURE Milk Can**



Buche, natur  
 Crasheisröhre und Kühlakku inkl. Tropfschale  
 und Edelstahlhahn  
*Natural Beech, crushed ice tube, cooling pack  
 incl. drip tray and Stainless Steel Faucet*

3 Liter / 3 liters

**RMC 030 X 004**

**Maße / Dimensions:**  
 383 225 220

5 Liter / 5 liters

**RMC 050 X**

**Maße / Dimensions:**  
 415 225 220



**Nachschubbehälter (12 Liter)**  
 inkl. Edelstahlhahn, FRILICH Zapf-  
 hahn-Adapter und Edelstahldeckel  
 für Eiswürfelkühlung und  
 Obst-Dekoration  
*Spare Container (12 liters)  
 Incl. stainless steel Faucet,  
 FRILICH Faucet Adapter and  
 Stainless Steel Lid for ice cube  
 cooling and Fruit Decoration*  
**AB 100 E**



**Nachschubbehälter (3 Liter)**  
 inkl. Crasheisröhre  
*Spare Container (3 liters)  
 incl. crushed ice tube*  
**EB 565 E**



**Nachschubbehälter (5 Liter)**  
 inkl. Crasheisröhre  
*Spare Container (5 liters)  
 incl. crushed ice tube*  
**EB 564 E**

**RAISER Getränke-Set 'Barrel'**  
RAISER Beverage-Set 'Barrel'

**RAISER Getränke-Set 'Barrel Individual'**  
RAISER Beverage-Set 'Barrel Individual'



Standfuß-Rahmen aus Holz, Dekor-Edelstahlplatte, Kühlkissen, Tropfschale, Glasbehälter mit Universaladapter und Edelstahlhahn.  
Wooden Stand, Decore Stainless Steel Frame, Cooling Cushion, Drip Tray, Glass Barrel with Universal Adapter and Stainless Steel Faucet.

**Barrel 'Vintage white'**  
Standfuß-Rahmen aus Fichte mit weißem Lack bearbeitet in 'used look'  
Wooden Stand made of spruce in white varnish in 'used look'

5 Liter  
**RSC 050 H 004**  
Maße / Dimensions: 470 x 230 x 315  
8 Liter  
**RSC 080 H 004**



**Standfußrahmen aus Fichte 'Vintage white'**  
mit weißem Lack in 'used look' inkl. Eiseinsatz und Kühlkissen, Dekor-Edelstahlplatte  
Wooden-Stand made of spruce with white varnish in 'used look' incl. Ice Insert and Cooling Cushion, Decore Frame, Stainless Steel

**RB 643 H 002**  
Maße / Dimensions: 200 x 228 x 228



Glasbehälter mit Bügelverschluss, Universal-Adapter und Edelstahlhahn  
Glass Container with Flip-Top Lid, Universal Adapter and Stainless Steel Faucet

Glasbehälter 'Barrel Classic'  
Glass Container 'Barrel Classic'  
5 Liter / 5 liters  
**RB 710 X 001**  
Maße / Dimensions:  
305 x 185 x 290  
8 Liter / 8 liters  
**RB 711 X 001**

Maße / Dimensions:  
360 x 210 x 315

**Standfuß-Set 'Barrel Individual'**  
Base-Set 'Barrel Individual'

Dekorplatten zur individuellen Gestaltung des Unterbaus  
Decore Discs for an individual Platform Setup



7 Scheiben / Discs (Ø 240 mm x 30)  
7 Scheiben / Discs (Ø 100 mm x 10)  
Birke (natur) / Birch, nature

**NB 008 H**



7 Scheiben / Discs (Ø 240 mm x 30)  
Travertin (Kalkstein) / Travertin (Limestone)

**NB 008 R 001**



**Barrel 'Nature'**  
Standfuß-Rahmen aus Fichte, natur.  
Wooden Stand made of spruce (bright).

5 Liter  
**RSC 050 H 006**  
Maße / Dimensions: 470 x 230 x 315  
8 Liter  
**RSC 080 H 006**

Maße / Dimensions: 533 x 251 x 360



**Standfußrahmen aus Fichte, natur**  
inkl. Eiseinsatz und Kühlkissen, Dekor-Edelstahlplatte  
Wooden-Stand made of spruce incl. Ice Insert and Cooling Cushion, Decore Frame, Stainless Steel

**RB 643 H 003**  
Maße / Dimensions: 200 x 251 x 251



**Standfußrahmen aus Eiche**  
inkl. Eiseinsatz und Kühlkissen, Dekor-Edelstahlplatte  
Wooden-Stand made of spruce incl. Ice Insert and Cooling Cushion, Decore Frame, Stainless Steel

**RB 643 H 006**  
Maße / Dimensions: 198 x 251 x 251



**Barrel 'Oak'**  
Standfuß-Rahmen aus Eiche, natur.  
Wooden Stand made of oak.

5 Liter  
**RSC 050 H 008**  
Maße / Dimensions: 478 x 251 x 360  
8 Liter  
**RSC 080 H 008**  
Maße / Dimensions: 525 x 230 x 330



Optional/optional

**Crasheisröhre**  
aus Acrylglas  
Crushed Ice Tube  
made of acrylic glass  
für 5 Liter / for 5 liters  
**8PL013**  
für 8 Liter / for 8 liters  
**8PL012**

**Aufgussröhre**  
aus Acrylglas  
Infusion Tube  
made of acrylic glass  
für 5 Liter / for 5 liters  
**8PL014**  
für 8 Liter / for 8 liters  
**8PL011**

Accessoire:



**Tropfschale**  
mit Tropfgitter  
aus Edelstahl  
Drip Dish with Drip Grill  
made of Stainless Steel

**RB 907 E**



Anwendungsbeispiele / Examples of use



**RAISER Getränke-Set '33 x 33'**  
**RAISER Beverage-Set '33 x 33'**



Edelstahlschale inkl. drei Kühlrippen\*, mit 20 Bügelflaschen (à 0,2 Liter) auf Standfussrahmen aus Eichenholz  
 Stainless steel tray incl. three cooling fins\*, with 20 Swing Top Bottles (à 0,2 liters) on Oak Base Frame

**Maße / Dimensions:**  
 H 352 L 352



Standfuss L **F09.400.0000** Standfuss S **F09.401.0000**

L: € 360 S: € 264

**RAISER Getränke-Set '23 x 23'**  
**RAISER Beverage-Set '23 x 23'**



Edelstahlschale inkl. zwei Kühlrippen\*, mit 9 Bügelflaschen (à 0,2 Liter) auf Standfussrahmen aus Eichenholz  
 Stainless steel tray incl. two cooling fins\*, with 9 Swing Top Bottles (à 0,2 liters) on Oak Base Frame

**Maße / Dimensions:**  
 H 252 L 252



Standfuss L **F10.400.0000** Standfuss S **F10.401.0000**

L: € 365 S: € 271



Edelstahlschale inkl. drei Kühlrippen\*, mit 20 Bügelflaschen (à 0,2 Liter) auf Standfussrahmen aus Fichtenholz, natur  
 Stainless steel tray incl. three cooling fins\*, with 20 Swing Top Bottles (à 0,2 liters) on Spruce Base Frame

**Maße / Dimensions:**  
 H 327 L 327



Standfuss L **F09.200.0000** Standfuss M: **F09.201.0000**

L: € 360 M: € 294



Edelstahlschale inkl. zwei Kühlrippen\*, mit 9 Bügelflaschen (à 0,2 Liter) auf Standfussrahmen aus Fichtenholz, natur  
 Stainless steel tray incl. two cooling fins\*, with 9 Swing Top Bottles (à 0,2 liters) on Spruce Base Frame

**Maße / Dimensions:**  
 H 228 L 228



Standfuss L **F10.200.0000** Standfuss M: **F10.201.0000**

L: € 366 M: € 301



Edelstahlschale inkl. drei Kühlrippen\*, mit 20 Bügelflaschen (à 0,2 Liter) auf Standfussrahmen aus Fichtenholz, weiß lackiert in 'used look'  
 Stainless steel tray incl. three cooling fins\*, with 20 Swing Top Bottles (à 0,2 liters) on Spruce Base Frame, white varnish in 'Used Look'

**Maße / Dimensions:**  
 H 327 L 327



Standfuss L **F09.300.0000** Standfuss M: **F09.301.0000**

L: € 360 M: € 294



Edelstahlschale inkl. zwei Kühlrippen\*, mit 9 Bügelflaschen (à 0,2 Liter) auf Standfussrahmen aus Fichtenholz, weiß lackiert in 'used look'  
 Stainless steel tray incl. two cooling fins\*, with 9 Swing Top Bottles (à 0,2 liters) on Spruce Base Frame, white varnish in 'Used Look'

**Maße / Dimensions:**  
 H 228 L 228



Standfuss L **F10.300.0000** Standfuss M: **RF10.301.0000**

L: € 366 M: € 301



Edelstahlschale inkl. drei Kühlrippen\*, mit 20 Bügelflaschen (à 0,2 Liter) auf Edelstahlstandfussrahmen  
 Stainless steel tray incl. three cooling fins\*, with 20 Swing Top Bottles (à 0,2 liters) on Stainless Steel Base Frame

**Maße / Dimensions:**  
 H 311 L 311



Standfuss L **F09.000.0000** Standfuss M: **F09.001.0000** Standfuss S **F09.002.0000**

L: € 348 M: € 298 S: € 248



Edelstahlschale inkl. zwei Kühlrippen\*, mit 9 Bügelflaschen (à 0,2 Liter) auf Edelstahlstandfussrahmen  
 Stainless steel tray incl. two cooling fins\*, with 9 Swing Top Bottles (à 0,2 liters) on Stainless Steel Base Frame

**Maße / Dimensions:**  
 H 211 L 211



Standfuss L **F10.000.0000** Standfuss M: **F10.001.0000** Standfuss S **F10.002.0000**

L: € 330 M: € 280 S: € 230



Edelstahlschale inkl. drei Kühlrippen\*, mit 20 Bügelflaschen (à 0,2 Liter) auf schwarzem Metallstandfussrahmen  
 Stainless steel tray incl. three cooling fins\*, with 20 Swing Top Bottles (à 0,2 liters) on Black Steel Base Frame

**Maße / Dimensions:**  
 H 335 L 335



Standfuss L **F09.100.0000** Standfuss M: **F09.101.0000** Standfuss S **F09.102.0000**

L: € 350 M: € 300 S: € 250



Edelstahlschale inkl. zwei Kühlrippen\*, mit 9 Bügelflaschen (à 0,2 Liter) auf schwarzem Metallstandfussrahmen  
 Stainless steel tray incl. two cooling fins\*, with 9 Swing Top Bottles (à 0,2 liters) on Black Steel Base Frame

**Maße / Dimensions:**  
 H 236 L 236



Standfuss L **F10.100.0000** Standfuss M: **F10.101.0000** Standfuss S **F10.102.0000**

L: € 332 M: € 282 S: € 232

! Kühlrippen und Bügelflaschen können zusätzlich nachbestellt werden Seite 106  
 Cooling Fins and Swing Top Bottles can also be ordered separately Page 106

! \*Kühlrippen bis Füllstrich mit Wasser füllen und einfrieren.  
 Fill up the Cooling Fins with water up to the measuring line.

**CARAFINE Getränke-Set 'Quintet'**  
**CARAFINE Beverage Set 'Quintet'**



Edelstahlkugel, doppelwandig mit Isolierung,  
 Edelstahl-Crasheisröhre zum Einstellen  
*Double Wall Stainless Steel Bowl  
 with stainless steel crushed ice tube in center*

**'Poliert' mit 5 Glaskaraffen**  
 (à 1,2 l) inkl. Edelstahldeckel  
*'Polished' with 5 Glass Carafes  
 (1.2 l ea.) with stainless steel lids*  
 ESC 060 E

**'Poliert' mit 5 Kunststoffkaraffen**  
 (à 1,2 l) inkl. Edelstahldeckel  
*'Polished' with 5 Plastic Carafes  
 (1.2 l ea.) with stainless steel lids*  
 ESC 060 E 001

**Maße / Dimensions:**  
 Ø 350 H 330



**'Hammered' mit 5 Glaskaraffen**  
 (à 1,2 l) inkl. Edelstahldeckel  
*'Hammered' with 5 Glass Carafes  
 (1.2 l ea.) with stainless steel lids*  
 ESC 060 E 002

**'Hammered' mit 5 Kunststoffkaraffen**  
 (à 1,2 l) inkl. Edelstahldeckel  
*'Hammered' with 5 Plastic Carafes  
 (1.2 l ea.) with stainless steel lids*  
 ESC 060 E 003

**Maße / Dimensions:**  
 Ø 350 H 330

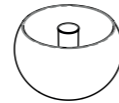

Edelstahlkugel, doppelwandig  
 mit Isolierung, Edelstahl-Crasheis-  
 röhre zum Einstellen  
*Double Wall Stainless Steel Bowl,  
 with stainless steel crushed ice tube  
 in center*

**'Poliert' / 'Polished'**  
 3BE005

**'Hammered' / 'Hammered'**  
 3BE015

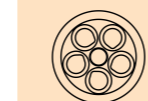

Draufsicht / Topview



**CARAFINE Getränke-Set 'Triplet'**  
**CARAFINE Beverage Set 'Triplet'**



Edelstahlkugel, doppelwandig mit Isolierung,  
 Edelstahl-Crasheisröhre zum Einstellen  
*Double Wall Stainless Steel Bowl  
 with stainless steel crushed ice tube in center*

**'Poliert' mit 3 Glaskaraffen**  
 (à 1,2 l) inkl. Edelstahldeckel  
*'Polished' with 3 Glass Carafes  
 (1.2 l ea.) with stainless steel lids*  
 ESC 036 E

**'Poliert' mit 3 Kunststoffkaraffen**  
 (à 1,2 l) inkl. Edelstahldeckel  
*'Polished' with 3 Plastic Carafes  
 (1.2 l ea.) with stainless steel lids*  
 ESC 036 E 001

**Maße / Dimensions:**  
 Ø 320 H 330



**'Hammered' mit 3 Glaskaraffen**  
 (à 1,2 l) inkl. Edelstahldeckel  
*'Hammered' with 3 Glass Carafes  
 (1.2 l ea.) with stainless steel lids*  
 ESC 036 E 002

**'Hammered' mit 3 Kunststoffkaraffen**  
 (à 1,2 l) inkl. Edelstahldeckel  
*'Hammered' with 3 Plastic Carafes  
 (1.2 l ea.) with stainless steel lids*  
 ESC 036 E 003

**Maße / Dimensions:**  
 Ø 320 H 330

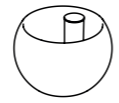

Edelstahlkugel, doppelwandig  
 mit Isolierung, Edelstahl-Crasheis-  
 röhre zum Einstellen  
*Double Wall Stainless Steel Bowl,  
 with stainless steel crushed ice tube  
 in center*

**'Poliert' / 'Polished'**  
 3BE007

**'Hammered' / 'Hammered'**  
 3BE017

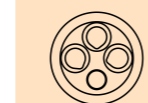

Draufsicht / Topview



**CARAFINE Getränke-Set 'Solo'**  
**CARAFINE Beverage Set 'Solo'**



**Inhalt: 1,2 Liter / Content: 1.2 liters**  
 Isolierter Standfuß mit 3 Kühlakkus im Edelstahlmantel  
*Insulated Base including 3 cooling packs and stainless steel shell*

**'Poliert' mit Kunststoffkaraffe (1,2 l)**  
 inkl. Edelstahldeckel  
*'Polished' with Plastic Carafe (1.2 l)  
 incl. Stainless Steel Lid*

**Edelstahl / Stainless Steel**  
 ESC 012 E 002

**Gold (24 Karat hartvergoldet)**  
*Gold (24-carat gold plated)*  
 ESC 012 G 001

**Maße / Dimensions:** Ø 165 H 310



Standfuß separat bestellen? Seite 108  
*Base ordered separately? Page 108*

**'Poliert' mit Glaskaraffe (1,2 l)**  
 inkl. Edelstahldeckel  
*'Polished' with Glass Carafe (1.2 l)  
 incl. Stainless Steel Lid*

**Edelstahl / Stainless Steel**  
 ESC 012 E.

**Gold (24 Karat hartvergoldet)**  
*Gold (24-carat gold plated)*  
 ESC 012 G





**CARAFINE Getränke-Set 'Septet'**  
*CARAFINE Beverage-Set 'Septet'*

**'Natur'**  
Holzfass (Robinienholz natur), Rahmeneinsatz für Flaschen (verchromt), Kunststoffeinsatz (transparent) zur Aufnahme von Crasheis oder Eiswürfel, sieben Bügelflaschen (à 1,0 l)  
*Wooden Bucket (black locust wood, nature), Support Frame for Bottles (chromium plated), Plastic Inset (transparent) for holding crushed ice or ice cubes, seven Swing Top Bottles (1,0 l ea.)*  
**LSC 070 H 001**

**Maße / Dimensions:**  
Ø 400 H 363



**'Vintage White'**  
Holzfass (Robinienholz) mit weißem Lack bearbeitet in 'used look', Rahmeneinsatz für Flaschen (verchromt), Kunststoffeinsatz (transparent) zur Aufnahme von Crasheis oder Eiswürfel, sieben Bügelflaschen (à 1,0 l)  
*Wooden Bucket (black locust wood), processed with white varnish in used look, Support Frame for Bottles (chromium plated) Plastic Inset (transparent) for holding crushed ice or ice cubes, seven Swing Top Bottles (1,0 l ea.)*  
**LSC 070 H 002**

**Maße / Dimensions:**  
Ø 400 H 363



**Holzfass 'Septet Natur'**  
inkl. Rahmeneinsatz und Kunststoffeinsatz  
*Wooden Bucket 'Septet Nature'*  
incl. Support Frame and Plastic Inset  
**LB 605**



**Holzfass 'Septet Vintage White'**  
inkl. Rahmeneinsatz und Kunststoffeinsatz  
*Wooden Bucket 'Septet Vintage'*  
incl. Support Frame and Plastic Inset  
**LB 606**



**Bügelflasche (1,0 l)**  
*Swing Top Bottle (1,0 l)*  
**3GL021**



**Kettenschild aus Holz**  
mit individueller Beschriftung  
*Label Chain (wood),*  
*Inscription of Choice*  
**5SC001**

Optional / Optional



**Glaskaraffe**  
mit Edelstahldeckel (1,2 l)  
*Glass Carafe with St. St. Lid*  
(1,2 l)  
**EB 581 E**



**Kunststoffkaraffe**  
mit Edelstahldeckel (1,2 l)  
*Plastic Carafe with St. St. Lid*  
(1,2 l)  
**EB 802 E**



**Flasche mit Milchmotiv**  
(1,0 l)  
und Silikonstopfen  
*Bottle with milk motif (1,0 l)*  
and Silicon Plug  
**LB 506**



Ohne Flasche  
*Without bottle*

**CARAFINE Getränke-Set 'Solo'**  
*CARAFINE Beverage-Set 'Solo'*

**'Natur'**  
Holzfass (Robinienholz natur), Kunststoffeinsatz (transparent) zur Aufnahme von Crasheis oder Eiswürfeln. Einstellen von FRILICH Flaschen, Karaffen bzw. Sekt- oder Champagnerflaschen  
*Wooden Bucket (black locust wood nature), Plastic Inset (transparent) for holding crushed ice or ice cubes. Display for FRILICH bottles, carafes or Champagne bottles*  
**LB 609**

**Maße / Dimensions:** Ø 230 H 180

**'Vintage White'**  
Holzfass (Robinienholz) mit weißem Lack in 'used look' bearbeitet, Kunststoffeinsatz (transparent) zur Aufnahme von Crasheis oder Eiswürfeln. Einstellen von FRILICH Flaschen, Karaffen bzw. Sekt- oder Champagnerflaschen  
*Wooden Bucket (black locust wood), processed with white varnish in used look, Plastic Inset (transparent) for holding crushed ice or ice cubes. Display for FRILICH bottles, carafes or Champagne bottles*  
**LB 610**

**Maße / Dimensions:** Ø 230 H 180

**CARAFINE Getränke-Set 'Crystal'**  
*CARAFINE Beverage-Set 'Crystal'*

Inhalt: 1,2 Liter / *Content: 1.2 liters*  
Standfuß und Standfußhaube aus spülmaschi-  
nengeeignetem Kunststoff (klar),  
Kunststoffkaraffe mit Edelstahldeckel,  
Edelstahl-Tropfschale  
*Base and Base Hood made of dishwasher proof*  
*plastic (light), Plastic Carafe with Stainless Steel*  
*Lid, Stainless Steel Drip Tray*

**ESC 012 E 001**

**Maße / Dimensions:**  
Ø 220 H 295



**Kunststoffkaraffe**  
mit Edelstahldeckel (1,2 l)  
*Plastic Carafe with St. St. Lid (1,2 l)*  
**EB 802 E**



**Standfußbehälter**  
Kunststoff für Crasheis  
bzw. Eiswürfel und Karaffe  
*Plastic Base Reservoir*  
for crushed ice or ice cubes and  
carafe  
**3BE010**

**ELEGANCE Saftkanne 'Twin'**  
*ELEGANCE Juice Dispenser 'Twin'*

Doppelte Präsentation von Säften im 4 und 5 Liter Behälter. Doppelte Kühlung durch Edelstahl-Crasheisröhre und Kühlakku im Standfuß.  
*Double presentation of juices in 4 and 5 liter dispensers. Double cooling by stainless steel crushed ice tube and cooling pack in the base.*

**ESC 090 E**  
**mit Edelhahn**  
mit Behälter 4 und 5 Liter  
*with Stainless Steel Faucet*  
*with container 4 and 5 liters*

**ESC 090 E 800**  
**mit Non-Drip-Hahn**  
mit Behälter 4 und 5 Liter,  
*with Non-Drip-Faucet*  
*with container 4 and 5 liters*

**Maße / Dimensions:**  
☞ 490 ☞ 355 ☞ 370



Edelstahlhahn  
*Stainless Steel Faucet*

Non-Drip-Hahn  
*Non-Drip-Faucet*

**CONNECT Saftkanne 'Juicer'**  
*CONNECT Juice Dispenser 'Juicer'*

Saftkanne aus Edelstahl, Acrylglasbehälter, Kühlakku im Standfuß sowie in der Deckelschale, inkl. Standfuß Modell 'Edelstahl' und Tropfschale sowie Edelhahn Juice Dispenser st. st., acrylic container, cooling pack in the base and in the small bowl below the lid, incl. base modul 'Stainless Steel' and drip tray as well as St. St. Faucet

**3 Liter / 3 liters:**  
**ESC 030 E 101**  
**Maße / Dimensions:**  
☞ 685 ☞ 170 ☞ 190

**4 Liter / 4 liters:**  
**ESC 040 E 101**  
**Maße / Dimensions:**  
☞ 825 ☞ 170 ☞ 190



**CONNECT Getränke-Set 'Carafine'**  
*CONNECT Beverage-Set 'Carafine'*

Karaffe 1,2 Liter, zur Präsentation von Milch, Säften und Wasser, mit Edelstahldeckel inkl. Standfuß Modell 'Edelstahl'  
*Carafe 1.2 liters, for beverage presentation (milk, juice, water etc.), with st. st. lid incl. base model 'Stainless Steel'*

mit Glaskaraffe / *with Glass Carafe*

**ESC 012 E 100**

mit Kunststoffkaraffe, spülmaschineneeignet  
*with Plastic Carafe, dishwasher proof*

**ESC 012 E 101**

mit Porzellankaraffe / *with China Carafe*

**EMC 012 E 100**

**Maße / Dimensions:** ☞ 300 ☞ 170 ☞ 154



**Glaskaraffe (1,2 Liter)**  
inkl. Edelstahldeckel  
*Glass Carafe (1.2 liters)*  
*incl. Stainless Steel Lid*  
**EB 581 E**

**Kunststoffkaraffe (1,2 Liter)**  
spülmaschineneeignet,  
inkl. Edelstahldeckel  
*Plastic Carafe (1.2 liters),*  
*dishwasher proof,*  
*incl. Stainless Steel Lid*  
**EB 802 E**

**Porzellankaraffe (1,2 Liter)**  
inkl. Edelstahldeckel  
*China Carafe (1.2 liters)*  
*incl. Stainless Steel Lid*  
**EB 801 E**

**Standfuß Modell 'Edelstahl'**  
*Base Model 'Stainless Steel'*  
**EB 634 E**

Nachschubbehälter / *Spare Container*

**'Juicer' Modul (3 Liter)**  
Edelstahlfuß mit Acryl-Kunststoff-behälter, Kühlakku, Edelstahldeckel und Edelhahn  
*'Juicer' Module (3 liters)*  
*St. st. base with acrylic container, cooling pack, st. st. lid and st. st. faucet*  
**EB 712 E 001**

**'Juicer' Modul (4 Liter)**  
Edelstahlfuß mit Acryl-Kunststoff-behälter, Kühlakku, Edelstahldeckel und Edelhahn  
*'Juicer' Module (4 liters)*  
*St. st. base with acrylic container, cooling pack, st. st. lid and st. st. faucet*  
**EB 713 E 001**

Optional / *optional*

**Standfuß Modell 'Edelstahl'**  
*Base Model 'Stainless Steel'*  
**EB 634 E**

**Reinigungsbürste**  
*Cleaning Brush*  
**3ZU026**



**ELEGANCE Saftkanne**  
*ELEGANCE Juice Dispenser*

Saftzylinder aus spülmaschinengeeignetem Kunststoff, Kühlakku im Standfuß sowie Edelstahl-Crasheisröhre, Edelstahltropfschale und Edelstahlhahn  
*Juice Container made of dishwasher proofed plastic, cooling pack in base, st. st. crushed ice tube, st. st. drip tray and st. st. faucet*

**5 Liter / 5 Liters****Edelstahl / Stainless Steel****ESC 050 E** mit transparentem Zylinder  
*with transparent container***ESC 050 E 900** mit Zylinder opal  
*with translucent container***Maße / Dimensions:**

☒ 490 ☒ 235 ☒ 370

**Nachschubbehälter (5 Liter)**  
inkl. Crasheisröhre und Edelstahlhahn  
*Spare Container (5 liters)*  
*incl. crushed ice tube and Stainless Steel Faucet***EB 502 E** (transparent)**EB 502 E 900** (opal/translucent)**2,5 Liter / 2,5 Liters****Edelstahl / Stainless Steel****ESC 025 E** mit transparentem Zylinder  
*with transparent container***ESC 025 E 900** mit Zylinder opal  
*with translucent container***Maße / Dimensions:**

☒ 435 ☒ 205 ☒ 336

**Nachschubbehälter (2,5 Liter)**  
inkl. Crasheisröhre und Edelstahlhahn  
*Spare Container (2.5 liters)*  
*incl. crushed ice tube and Stainless Steel Faucet***EB 562 E** (transparent)**EB 562 E 900** (opal/translucent)**ELEGANCE Saftkanne**  
*ELEGANCE Juice Dispenser*

Saftzylinder aus spülmaschinengeeignetem Kunststoff, Kühlakku im Standfuß sowie Edelstahl-Crasheisröhre, Edelstahltropfschale und Edelstahlhahn  
*Juice Container made of dishwasher proofed plastic, cooling pack in base, st. st. crushed ice tube, st. st. drip tray and st. st. faucet*

**5 Liter / 5 Liters****Gold (24 Karat hartvergoldet)**  
*Gold (24-carat gold plated)***ESC 050 G** mit transparentem Zylinder  
*with transparent container***ESC 050 G 900** mit Zylinder opal  
*with translucent container***Maße / Dimensions:**

☒ 490 ☒ 235 ☒ 370

**2,5 Liter / 2,5 Liters****Gold (24 Karat hartvergoldet)**  
*Gold (24-carat gold plated)***ESC 025 G** mit transparentem Zylinder  
*with transparent container***ESC 025 G 900** mit Zylinder opal  
*with translucent container***Maße / Dimensions:**

☒ 435 ☒ 205 ☒ 336

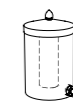
**Nachschubbehälter (5 Liter)**  
inkl. Crasheisröhre und Edelstahlhahn  
*Spare Container (5 liters)*  
*incl. crushed ice tube and Stainless Steel Faucet***EB 502 G** (transparent)**EB 502 G 900** (opal/translucent)**Nachschubbehälter (2,5 Liter)**  
inkl. Crasheisröhre und Edelstahlhahn  
*Spare Container (2.5 liters)*  
*incl. crushed ice tube and Stainless Steel Faucet***EB 562 G** (transparent)**EB 562 G 900** (opal/translucent)**ELEGANCE Milchkanne**  
*ELEGANCE Milk Can*

Milchbehälter aus Edelstahl, Kühlakku im Standfuß sowie Edelstahl-Crasheisröhre, Edelstahltropfschale und Edelstahlhahn  
*Milk Container made of Stainless Steel, cooling pack in base, st. st. crushed ice tube, st. st. drip tray and st. st. faucet*

**3 Liter / 3 Liters****Edelstahl / Stainless Steel****EMC 030 E****Gold (24 Karat hartvergoldet)**  
*Gold (24-carat gold plated)***EMC 030 G****Maße / Dimensions:**

☒ 400 ☒ 205 ☒ 336

**Nachschubbehälter (3 Liter)**  
inkl. Crasheisröhre und Edelstahlhahn  
*Spare Container (3 liters)*  
*incl. crushed ice tube and Stainless Steel Faucet***EB 565 E** Edelstahl/Stainless Steel**EB 565 G** Gold/Gold**ELEGANCE Milchkanne**  
*ELEGANCE Milk Can*

Milchbehälter aus Edelstahl, Kühlakku im Standfuß sowie Edelstahl-Crasheisröhre, Edelstahltropfschale und Edelstahlhahn  
*Milk Container made of Stainless Steel, cooling pack in base, st. st. crushed ice tube, st. st. drip tray and st. st. faucet*

**5 Liter / 5 Liters****Edelstahl / Stainless Steel****EMC 050 E****Gold (24 Karat hartvergoldet)**  
*Gold (24-carat gold plated)***EMC 050 G****Maße / Dimensions:**

☒ 440 ☒ 235 ☒ 370

**Nachschubbehälter (5 Liter)**  
inkl. Crasheisröhre und Edelstahlhahn  
*Spare Container (5 liters)*  
*incl. crushed ice tube and Stainless Steel Faucet***EB 564 E** Edelstahl/  
Stainless Steel**EB 564 G** Gold/Gold**!** Tropfschale, Edelstahlhahn und Milchbehälter sind nicht vergoldet.  
*Drip Tray, St. St. Faucets and Milk Container are not gold plated.*

**ELEGANCE Saftkanne 'Extra'**  
*ELEGANCE Juice Dispenser 'Extra'*

**5 Liter / 5 Liters**  
mit elektrischem Deckelrührsystem  
*with electrical lid stirring system*

**Edelstahl / Stainless Steel**

**ESC 050 E 005** mit transparentem Zylinder  
*with transparent container*

**ESC 050 E 905** mit Zylinder opal  
*with translucent container*

**Gold (24 Karat hartvergoldet)**  
*Gold (24-carat gold plated)*

**ESC 050 G 005** mit transparentem Zylinder  
*with transparent container*

**ESC 050 G 905** mit Zylinder opal  
*with translucent container*

**Maße / Dimensions:**  
☞ 475 ☜ 235 ☚ 370



**Nachschubbehälter (5 Liter)**  
inkl. Crasheisröhre und Edelstahlhahn  
*Spare Container (5 liters)*  
*incl. crushed ice tube and St. St. Faucet*

Modell Edelstahl / *Model Stainless Steel*

**EB 502 E** (transparent)

**EB 502 E 900** (opal/translucent)

Modell Gold / *Model Gold*

**EB 502 G** (transparent)

**EB 502 G 900** (opal/translucent)

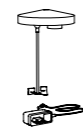

**Rührwerk (Nachrüstset)**  
*Stirring Kit (add-on)*

**EB 547 E** Edelstahl / *Stainless Steel*

**EB 547 G** Gold



mit transparentem Zylinder  
*with transparent Container*

**ELEGANCE Saftkanne 'Aktiv'**  
*ELEGANCE Juice Dispenser 'Aktiv'*

**5 Liter / 5 Liters**  
Standfuß mit elektrischer Kühlung  
und Deckelrührsystem  
*Base with electrical cooling system*  
*and lid stirring system*

**Edelstahl / Stainless Steel**

**ESC 050 E 023** mit transparentem Zylinder  
*with transparent container*

**ESC 050 E 923** mit Zylinder opal  
*with translucent container*

**Gold (24 Karat hartvergoldet)**  
*Gold (24-carat gold plated)*

**ESC 050 G 023** mit transparentem Zylinder  
*with transparent container*

**ESC 050 G 923** mit Zylinder opal  
*with translucent container*

**Maße / Dimensions:**  
☞ 495 ☜ 235 ☚ 370



**Nachschubbehälter (5 Liter)**  
inkl. Kühlbodenplatte (Aluminium)  
und Edelstahlhahn  
*Spare Container (5 liters)*  
*incl. cooling bottom plate (aluminium)*  
*and Stainless Steel Faucet*

Modell Edelstahl / *Model Stainless Steel*

**EB 566 E** (transparent)

**EB 566 E 900** (opal/translucent)

Modell Gold / *Model Gold*

**EB 566 G** (transparent)

**EB 566 G 900** (opal/translucent)



mit transparentem Zylinder  
*with transparent Container*

**ELEGANCE Saftkanne**  
*ELEGANCE Juice Dispenser*

**9 Liter / 9 Liters**

**Edelstahl / Stainless Steel**

**BSC 090 E**

**Gold (24 Karat hartvergoldet)**  
*Gold (24-carat gold plated)*

**BSC 090 G**

**Maße / Dimensions:**  
☞ 550 ☜ 285 ☚ 362

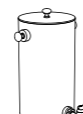

**Nachschubbehälter (9 Liter)**  
inkl. Edelstahlhahn und Griffe  
*Spare Container (9 liters)*  
*incl. Stainless Steel Faucet and knobs*

**BB 549 E** Edelstahl / *Stainless Steel*

**BB 549 G** Gold / *Gold*



**ELEGANCE Milchkanne 'Aktiv'**  
*ELEGANCE Milk Can 'Aktiv'*

**5 Liter / 5 Liters**  
Standfuß mit elektrischer Kühlung  
und Deckelrührsystem  
*Base with electrical cooling system*  
*and lid stirring system*

**Edelstahl / Stainless Steel**

**EMC 050 E 007**

**Gold (24 Karat hartvergoldet)**  
*Gold (24-carat gold plated)*

**EMC 050 G 007**

**Maße / Dimensions:**  
☞ 495 ☜ 235 ☚ 370



**Nachschubbehälter (5 Liter)**  
mit Edelstahlhahn  
*Spare Container (5 liters)*  
*with Stainless Steel Faucet*

**BB 506 E** Edelstahl / *Stainless Steel*

**BB 506 G** Gold / *Gold*



! Tropfschale, Edelstahlhahn und Milchbehälter sind nicht vergoldet.  
*Drip Tray, St. St. Faucets and Milk Container are not gold plated.*



**B-LINE Saftkanne**  
*B-LINE Juice Dispenser*

Behälter, spülmaschineneignet inkl. Deckel aus Kunststoff. Edelstahlstandfuß mit Kühlakku, Non-Drip-Hahn, Tropfschale aus Kunststoff.  
*Container, suitable for dishwasher use incl. lid made of plastic. Stainless Steel base with cooling pack, non-drip-faucet, drip tray made of plastic.*

2,5 Liter / 2.5 liters

**XSC 025 E 004**

**Maße / Dimensions**  
 ☰ 425 ☱ 200 ☲ 330

5 Liter / 5 liters

**XSC 050 E 004**

**Maße / Dimensions**  
 ☰ 485 ☱ 220 ☲ 350

**B-LINE Milchkanne**  
*B-LINE Milk Can*

Behälter inkl. Deckel aus Edelstahl. Edelstahlstandfuß mit Kühlakku, Non-Drip-Hahn, Tropfschale aus Kunststoff.  
*Container incl. lid made of stainless steel, Stainless Steel base with cooling pack, non-drip-faucet, drip tray made of plastic.*

3 Liter / 3 liters

**XMC 030 E 001**

**Maße / Dimensions**  
 ☰ 395 ☱ 200 ☲ 350

5 Liter / 5 liters

**XMC 050 E 002**

**Maße / Dimensions**  
 ☰ 455 ☱ 220 ☲ 350

**MÜSLI, KONFI & HONIG / MUESLI, JAM & HONEY**

Für den süßen Brotaufstrich und die Cerealien gibt es eine große Auswahl an Spendern und Displays, die für eine moderne oder aber auch rustikale Präsentation sorgen. Dabei bleibt die Funktionalität immer ein wichtiger Baustein bei den FRILICH Artikeln, damit das Buffet nicht nur gut aussieht, sondern auch Pflege und Handling gut von der Hand gehen.

*For the sweet spread and cereals, there is a large selection of dispensers and displays that make for a modern and rustic presentation. The functionality is always an important component of FRILICH products, so that the buffet not only looks good, but also easy to care for and handle.*

**CONNECT Müslibar 'Flöte'**  
*CONNECT Muesli Bar 'Flute'*



Müsliflöte 1,5 Liter, zur Präsentation von Cerealien, inkl. Standfuß Modell 'Edelstahl'  
*Muesli Flute 1.5 liters, for muesli presentation, incl. base model 'Stainless Steel'*

**ETO 015 E 100**  
**Maße / Dimensions:**  
☞ 290 ☞ 170 ☞ 154



**Nachschubgefäß (1,5 Liter)**  
inkl. Edelstahldeckel und 'Gute-Nacht-Deckel'  
*Spare Flute (1.5 liters)*  
incl. Stainless steel press-on lid and 'Good Night Lid'  
**EB 549 E** Edelstahl / Stainless Steel



**Standfuß Modell 'Edelstahl'**  
*Base Model 'Stainless Steel'*  
**EB 634 E**

**CONNECT Müslibar 'Goblet'**  
*CONNECT Muesli Bar 'Goblet'*



Porzellankegel 2 Liter, zur Präsentation von Cerealien, inkl. Standfuß Modell 'Edelstahl'  
*China Slide 2 liters, for muesli presentation, incl. base model 'Stainless Steel'*

**ETO 200 E 100**  
**Maße / Dimensions:**  
☞ 305 ☞ 170 ☞ 220



**Porzellankegel (2 Liter)**  
*China Slide (2 liters)*  
**3P0036**



**Standfuß Modell 'Edelstahl'**  
*Base Model 'Stainless Steel'*  
**EB 634 E**

**CONNECT Konfitürenbar 'Cup'**  
*CONNECT Jam Bar 'Cup'*



Behälter 0,6 Liter zur Präsentation von Konfitüre, mit Edelstahldeckel inkl. Standfuß Modell 'Edelstahl'  
*Pot 0.6 liters for jam presentation with st. lid incl. base model 'Stainless Steel'*

mit Kunststoffbehälter (opal), spülmaschinengeeignet  
*with Plastic Pot (translucent), dishwasher proof*

**ECO 006 E 100**

mit Porzellanbehälter / with China Pot

**ECO 006 E 101**

**Maße / Dimensions:**  
☞ 175 ☞ 170 ☞ 154



**Nachschubgefäß (0,6 Liter)**  
mit Edelstahldeckel, spülmaschinengeeignet  
*Spare pot (0.6 liters)*  
incl. Stainless steel lid, dishwasher proof



**mit Kunststoffbehälter (opal)**  
inkl. Gute-Nacht-Deckel'  
*with Plastic Pot (translucent) and Good Night Lid'*  
**EB 585 E**



**mit Porzellanbehälter / with China Pot**  
**LB 552 E**



**Standfuß Modell 'Edelstahl'**  
*Base Model 'Stainless Steel'*  
**EB 634 E**



**CONNECT Müslibar 'Hopper'**  
*CONNECT Muesli Bar 'Hopper'*



Müsli-Drehspender aus Edelstahl zur Präsentation von Cerealien, Acrylglasbehälter, Edelstahldeckel und Edelstahldrehachse inkl. Standfuß Modell 'Edelstahl'  
*Rotary Dispenser st. st. for muesli presentation, acrylic container, st. lid and st. st. rotational axis incl. base model 'Stainless Steel'*

**2,5 Liter / 2.5 liters:**  
**ETO 250 E 100**  
**Maße / Dimensions:**  
☞ 725 ☞ 170 ☞ 190

**3,5 Liter / 3.5 liters:**  
**ETO 350 E 100**  
**Maße / Dimensions:**  
☞ 825 ☞ 170 ☞ 190

**4,5 Liter / 4.5 liters:**  
**ETO 450 E 100**  
**Maße / Dimensions:**  
☞ 965 ☞ 170 ☞ 190



**'Hopper' Modul**  
Edelstahlfuß mit Acryl-Kunststoffbehälter, Drehgriff und Deckel aus Edelstahl  
*'Hopper' Module*  
St. st. base with acrylic container, st. st. rotational axis and lid

**2,5 Liter / 2.5 liters:**  
**EB 599 E 250**

**3,5 Liter / 3.5 liters:**  
**EB 599 E 350**

**4,5 Liter / 4.5 liters:**  
**EB 599 E 450**



**Standfuß Modell 'Edelstahl'**  
*Base Model 'Stainless Steel'*  
**EB 634 E**



Optional / optional:  
**Reinigungsbürste**  
*Cleaning Brush*  
**3ZU026**

**ELEGANCE Konfitürenbar 'Trio'**  
ELEGANCE Jam Bar 'Trio'



Kunststoffbehälter (opal)  
Inhalt: je 0,6 Liter  
Plastic Pot (translucent), Content: 0.6 liters ea.

Edelstahl / Stainless Steel  
ECO 018 E

Gold / Gold  
ECO 018 G

Maße / Dimensions:  
180 470 140



**Nachschubgefäß (0,6 Liter)**  
mit Edelstahldeckel und  
'Gute-Nacht-Deckel'  
Spare pot (0.6 liters)  
incl. Stainless steel lid and  
'Good Night Lid'

EB 585 E Edelstahl /  
Stainless Steel

EB 585 G Gold / Gold

**ELEGANCE Konfitürenbar 'Quadro'**  
ELEGANCE Jam Bar 'Quadro'



Kunststoffbehälter (opal), Inhalt: je 0,6 Liter  
Plastic Pot (translucent), content: 0.6 liters ea.

Edelstahl / Stainless Steel  
ECO 024 E 004

Gold / Gold  
ECO 024 G 004

Maße / Dimensions:  
180 600 140



**ELEGANCE Müslibar 'Trio'**  
ELEGANCE Muesli Bar 'Trio'



Kunststoffbehälter, Inhalt: je 1,5 Liter  
Plastic Flute, Content: 1.5 liters ea.

Edelstahl / Stainless Steel  
ETO 045 E 002

Gold / Gold  
ETO 045 G 002

Maße / Dimensions:  
290 470 140



**Nachschubgefäß (1,5 Liter)**  
inkl. Edelstahldeckel und  
'Gute-Nacht-Deckel'  
Spare Flute (1.5 liters)  
incl. Stainless steel press-on lid  
and 'Good Night Lid'

EB 549 E Edelstahl /  
Stainless Steel

EB 549 G Gold / Gold

**ELEGANCE Müslibar 'Quadro'**  
ELEGANCE Muesli Bar 'Quadro'



Kunststoffbehälter, Inhalt: je 1,5 Liter  
Plastic Flute, Content: 1.5 liters ea.

Edelstahl / Stainless Steel  
ETO 060 E 002

Gold / Gold  
ETO 060 G 002

Maße / Dimensions:  
290 600 140



**ELEGANCE Honigspender**  
ELEGANCE Honey Holder



Tropfenfreie Dosierung für 1 kg flüssigen Honig,  
Edelstahlgestell, Bedienhebel aus Edelstahl,  
Behälter und Dosierventil spülmaschinen-  
geeignet, Edelstahldeckel

Dripless dosage for 1 kg liquid honey, st. st. rack,  
st. st. operating lever, Container and dispensing  
valve are dishwasher-proof, stainless steel lid

EHO 010 E Edelstahl / St. St.

EHO 010 G Gold / Gold

Maße / Dimensions:  
Ø 210 350 235



Edelstahldeckel  
Stainless Steel Lid  
EB 593 E



Edelstahldeckel, vergoldet  
Stainless Steel Lid, gold-plated  
EB 593 G

**RAISER Buffetsystem 'Buffet Bowl Medium 23 x 23' / RAISER Buffet System 'Buffet Bowl Medium 23 x 23'**

Porzellankugel (1,5 Liter) inkl. Porzellandeckel auf Standfußrahmen aus Eichenholz, Edelstahl-Dekorplatte  
China Bowl with Lid (1,5 liters) on Oak Base Frame, st. st. décor frame

**S-Standfuß 'Oak' / S-Base Frame 'Oak' · Maße / Dimension: 274 251 251**



weiß / white F08.401.0000    blau / blue F08.401.0001    rot / red F08.401.0002    grau / grey F08.401.0003    caramel / caramel F08.401.0004

**L-Standfuß 'Oak' / L-Base Frame 'Oak' · Maße / Dimension: 367 251 251**



weiß / white F08.400.0000    blau / blue F08.400.0001    rot / red F08.400.0002    grau / grey F08.400.0003    caramel / caramel F08.400.0004

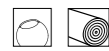

**RAISER Buffetsystem 'Buffet Bowl Maxi 23 x 23' / RAISER Buffet System 'Buffet Bowl Maxi 23 x 23'**

Porzellankugel (3,5 Liter) inkl. Porzellandeckel auf Standfußrahmen aus Eichenholz, Edelstahl-Dekorplatte  
China Bowl with Lid (3,5 liters) on Oak Base Frame, st. st. décor frame

**S-Standfuß 'Oak' / S-Base Frame 'Oak' · Maße / Dimension: 336 251 251**



weiß / white F07.401.0000    blau / blue F07.401.0001    rot / red F07.401.0002    grau / grey F07.401.0003    caramel / caramel F07.401.0004

**L-Standfuß 'Oak' / L-Base Frame 'Oak' · Maße / Dimension: 430 251 251**



weiß / white F07.400.0000    blau / blue F07.400.0001    rot / red F07.400.0002    grau / grey F07.400.0003    caramel / caramel F07.400.0004



Porzellankugel (1,5 Liter) inkl. Porzellandeckel auf Standfußrahmen aus Fichtenholz, natur, Edelstahl-Dekorplatte  
China Bowl with Lid (1,5 liters) on Spruce Base Frame, st. st. décor frame

**M-Standfuß 'Spruce' / M-Base Frame 'Spruce' · Maße / Dimension: 305 228 228**



weiß / white F08.201.0000    blau / blue F08.201.0001    rot / red F08.201.0002    grau / grey F08.201.0003    caramel / caramel F08.201.0004

**L-Standfuß 'Spruce' / L-Base Frame 'Spruce' · Maße / Dimension: 369 228 228**



weiß / white F08.200.0000    blau / blue F08.200.0001    rot / red F08.200.0002    grau / grey F08.200.0003    caramel / caramel F08.200.0004



Porzellankugel (3,5 Liter) inkl. Porzellandeckel auf Standfußrahmen aus Fichtenholz, natur, Edelstahl-Dekorplatte  
China Bowl with Lid (3,5 liters) on Spruce Base Frame, st. st. décor frame

**M-Standfuß 'Spruce' / M-Base Frame 'Spruce' · Maße / Dimension: 365 228 228**



weiß / white F07.201.0000    blau / blue F07.201.0001    rot / red F07.201.0002    grau / grey F07.201.0003    caramel / caramel F07.201.0004

**L-Standfuß 'Spruce' / L-Base Frame 'Spruce' · Maße / Dimension: 430 228 228**



weiß / white F07.200.0000    blau / blue F07.200.0001    rot / red F07.200.0002    grau / grey F07.200.0003    caramel / caramel F07.200.0004



Porzellankugel (1,5 Liter) inkl. Porzellandeckel auf Standfußrahmen aus Fichtenholz, weiß lackiert in 'used look',  
Edelstahl-Dekorplatte / China Bowl with Lid (1,5 liters) on Spruce Base Frame, white varnish in 'used look', st. st. décor frame

**M-Standfuß 'Vintage White' / M-Base Frame 'Vintage White' · Maße / Dimension: 305 228 228**



weiß / white F08.301.0000    blau / blue F08.301.0001    rot / red F08.301.0002    grau / grey F08.301.0003    caramel / caramel F08.301.0004

**L-Standfuß 'Vintage White' / L-Base Frame 'Vintage White' · Maße / Dimension: 369 228 228**



weiß / white F08.300.0000    blau / blue F08.300.0001    rot / red F08.300.0002    grau / grey F08.300.0003    caramel / caramel F08.300.0004

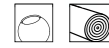

Porzellankugel (3,5 Liter) inkl. Porzellandeckel auf Standfußrahmen aus Fichtenholz, weiß lackiert in 'used look',  
Edelstahl-Dekorplatte / China Bowl with Lid (3,5 liters) on Spruce Base Frame, white varnish in 'used look', st. st. décor frame

**M-Standfuß 'Vintage White' / M-Base Frame 'Vintage White' · Maße / Dimension: 365 228 228**



weiß / white F07.301.0000    blau / blue F07.301.0001    rot / red F07.301.0002    grau / grey F07.301.0003    caramel / caramel F07.301.0004

**L-Standfuß 'Vintage White' / L-Base Frame 'Vintage White' · Maße / Dimension: 430 228 228**



weiß / white F07.300.0000    blau / blue F07.300.0001    rot / red F07.300.0002    grau / grey F07.300.0003    caramel / caramel F07.300.0004





**RAISER Buffetsystem 'Buffet Bowl Medium 23 x 23' / RAISER Buffet System 'Buffet Bowl Medium 23 x 23'**

Porzellankugel (1,5 Liter) inkl. Porzellandeckel auf Standfußrahmen aus Edelstahl, Edelstahl-Dekorplatte  
China Bowl with Lid (1,5 liters) on Stainless Steel Base Frame, st. st. décor frame

**S-Standfuß 'Stainless Steel' / S-Base Frame 'Stainless Steel' · Maße / Dimension: 233 H 211 L 211**



weiß / white  
F08.002.0000



blau / blue  
F08.002.0001



rot / red  
F08.002.0002



grau / grey  
F08.002.0003



caramel / caramel  
F08.002.0004

**M-Standfuß 'Stainless Steel' / M-Base Frame 'Stainless Steel' · Maße / Dimension: 283 H 211 L 211**



weiß / white  
F08.001.0000



blau / blue  
F08.001.0001



rot / red  
F08.001.0002



grau / grey  
F08.001.0003



caramel / caramel  
F08.001.0004

**L-Standfuß 'Stainless Steel' / L-Base Frame 'Stainless Steel' · Maße / Dimension: 333 H 211 L 211**



weiß / white  
F08.000.0000



blau / blue  
F08.000.0001



rot / red  
F08.000.0002



grau / grey  
F08.000.0003



caramel / caramel  
F08.000.0004



**RAISER Buffetsystem 'Buffet Bowl Maxi 23 x 23' / RAISER Buffet System 'Buffet Bowl Maxi 23 x 23'**

Porzellankugel (3,5 Liter) inkl. Porzellandeckel auf Standfußrahmen aus Edelstahl, Edelstahl-Dekorplatte  
China Bowl with Lid (3,5 liters) on Stainless Steel Base Frame, st. st. décor frame

**S-Standfuß 'Stainless Steel' / S-Base Frame 'Stainless Steel' · Maße / Dimension: 296 H 220 L 220**



weiß / white  
F07.002.0000



blau / blue  
F07.002.0001



rot / red  
F07.002.0002



grau / grey  
F07.002.0003



caramel / caramel  
F07.002.0004

**M-Standfuß 'Stainless Steel' / M-Base Frame 'Stainless Steel' · Maße / Dimension: 346 H 220 L 220**



weiß / white  
F07.001.0000



blau / blue  
F07.001.0001



rot / red  
F07.001.0002



grau / grey  
F07.001.0003



caramel / caramel  
F07.001.0004

**L-Standfuß 'Stainless Steel' / L-Base Frame 'Stainless Steel' · Maße / Dimension: 396 H 220 L 220**



weiß / white  
F07.000.0000



blau / blue  
F07.000.0001



rot / red  
F07.000.0002



grau / grey  
F07.000.0003



caramel / caramel  
F07.000.0004



**RAISER Buffetsystem 'Buffet Bowl Medium 23 x 23' / RAISER Buffet System 'Buffet Bowl Medium 23 x 23'**

Porzellankugel (1,5 Liter) inkl. Porzellandeckel auf Metallstandfußrahmen (schwarz), Black Steel-Dekorplatte  
China Bowl with Lid (1,5 liters) on Black Steel Base Frame, Black Steel Décor Frame

**S-Standfuß 'Stainless Steel' / S-Base Frame 'Black Steel' · Maße / Dimension: 235 236 236**



**M-Standfuß 'Black Steel' / M-Base Frame 'Black Steel' · Maße / Dimension: 285 236 236**



**L-Standfuß 'Black Steel' / L-Base Frame 'Black Steel' · Maße / Dimension: 335 236 236**



**PURE NATURE Zutaten-Display 'Bowl Bar' / PURE NATURE Condiment Display 'Bowl Bar'**

Buche hell / Natural Beech

**Bowl Bar S**

Inhalt: je 0,5 Liter  
besonders für Konfitüre und Nüsse geeignet  
Content: 0.5 liters each  
particularly suitable for jam and nuts

**RCO 015 X 002**

**Maße / Dimensions:**

210 450 125

**Bowl Bar M**

Inhalt: je 1,5 Liter  
besonders für Cerealien und Obst geeignet  
Content: 1.5 liters each  
particularly suitable for cereals and fruits

**RCO 045 X 002**

**Maße / Dimensions:**

285 600 190

**Bowl Bar L**

Inhalt: je 3,5 Liter  
besonders für Cerealien und Obst geeignet  
Content: 3.5 liters each  
particularly suitable for cereals and fruits

**RCO 105 X 002**

**Maße / Dimensions:**

375 750 250



**RAISER Buffetsystem 'Buffet Bowl Maxi 23 x 23' / RAISER Buffet System 'Buffet Bowl Maxi 23 x 23'**

Porzellankugel (3,5 Liter) inkl. Porzellandeckel auf Metallstandfußrahmen (schwarz), Black Steel-Dekorplatte  
China Bowl with Lid (3,5 liters) on Black Steel Base Frame, Black Steel Décor Frame

**S-Standfuß 'Black Steel' / S-Base Frame 'Black Steel' · Maße / Dimension: 295 236 236**



**M-Standfuß 'Black Steel' / M-Base Frame 'Black Steel' · Maße / Dimension: 345 236 236**



**L-Standfuß 'Black Steel' / L-Base Frame 'Black Steel' · Maße / Dimension: 395 236 236**



**B-LINE Standfuß** in zwei verschiedenen Größen aus Edelstahl.  
Kombinationsmöglichkeit mit Konfitürenbehälter und / oder Müsliflöten.  
Bitte beachten: die Behälter werden separat bestellt.  
*B-LINE Base made of stainless steel in two different sizes.  
Possibility to combine with Cups for Jam and / or Muesli flute.  
Please note that the containers have to be ordered separately.*



**Anwendungsbeispiel A / Example of use A**  
Maße / Dimensions 280 x 525 x 140



**Anwendungsbeispiel B / Example of use B**  
Maße / Dimensions 280 x 400 x 140



**Anwendungsbeispiel C / Example of use C**  
Maße / Dimensions 150 x 525 x 140

**Papierschilder:**

Mit dem Standfuß erhalten Sie die Formatvorlage zum Ausdrucken und Ausschneiden der passenden Sortenschilder. Oder fordern Sie die Formatvorlage direkt bei FRILICH an.

*Paper Label: will come along the delivery of the stainless steel base.  
Style sheet for printing and cutting out the suitable paper labels.  
Or ask your FRILICH contact person for a free data file.*

**B-LINE Müsli- und Konfitürenbar**  
*B-LINE Muesli and Jam Bar*

**Edelstahlstandfuß / Stainless Steel base**

für die Präsentation von verschiedenen Sorten. Schlitz zum Einstellen von Sortenschildern.  
*For a presentation of different sorts incl. slits for displaying labels.*



für 3 Sorten / for 3 sorts **XB 560 E**  
Maße / Dimensions 45 x 400 x 140



für 4 Sorten / for 4 sorts **XB 561 E**  
Maße / Dimensions 45 x 525 x 140

**Konfitürenbehälter 0,6 Liter**  
*Jam Pot, 0,6 liters*

spülmaschinengeeignet inkl. Kunststoffdeckel mit Löffelaussparung, transparent.  
*dishwasher-proof incl. plastic lid with spoon-cut-off, transparent.*



**XB 565**  
Maße / Dimensions 145 x 105 x 105

**Müsliflöte aus Kunststoff, 1,5 Liter**  
*Muesli Flute in plastic, 1,5 liters*

spülmaschinengeeignet inkl. Deckel aus Kunststoff, rauchfarben.  
*dishwasher-proof incl. plastic lid with spoon-cut-off, smoke-colored.*



**XB 563**  
Maße / Dimensions 275 x 135 x 105



**WURST, KÄSE, SALATE & JOGHURT / COLD CUTS, SALADS & YOGHURT**

Bei Wurst, Käse, Joghurt und Salaten ist es besonders wichtig, dass die Temperatur stimmt und die Produkte geschützt, aber doch auch ansprechend präsentiert werden. FRILICH bietet ein breites Sortiment an verschiedenen Buffetlösungen, die unabhängig von fest installierten Kühlmöglichkeiten überall und flexibel eingesetzt werden können. Der Fokus von FRILICH Lösungen liegt dabei immer auf dem Design, ohne dabei die notwendige Funktionalität für den gastronomischen Einsatz aus dem Blick zu verlieren.

*With sausages, cheese, yoghurt and salads, it is particularly important, that the temperature on the buffet is right and the products are protected, but at the same time presented in an appealing way. FRILICH offers a wide range of different buffet solutions, that can be used anywhere and flexibly, regardless of fixed cooling options. The focus of FRILICH solutions is always on design, without losing sight of the important functionality for gastronomic use.*

**PICKNICK Frischeplatte '400'**  
*PICKNICK Freshness Plate '400'*



mit Porzellanplatte (Ø 410 mm),  
 Standfuß aus spülmaschineneigenem  
 Weidekorb (Kunststoff), Standfußbeinsatz aus  
 Isoliermaterial, Kühlkissen  
*with China Plate (Ø 410 mm), Base made of  
 dishwasher proof Wicker Basket (plastic),  
 Insulated Cooling Inset, Cooling Cushion*

**NFC 000 B 402** (beige)  
**NFC 000 B 403** (grau/grey))

**Maße / Dimensions:**  
 70 410 410



Anwendungsbeispiel / Example of use

**Frischeplatte inkl. Haubensystem**  
*Freshness Plate incl. Hood System*  
 335 410 435

**Haubensystem '400 Platte'**  
*Hood System '400 Plate'*



Halterung aus Edelstahl, klappbar, transparente  
 Kunststoffhaube (Ø 400 mm) mit Edelstahlgriff  
*Stainless Steel Holding device, transparent  
 Plastic Hood (Ø 400 mm), with Stainless Steel Handle*  
**NB 001 E**



**Porzellanplatte '400'**  
*Spare China Platter '400'*  
**3PO048**



**Haube / Deckel '400'**  
 transparente Kunststoffhaube (Ø 400 mm)  
 inkl. Edelstahlgriff  
**Hood / Lid '400'**  
 transparent Plastic Hood (Ø 400 mm)  
 incl. Stainless Steel Knob  
**EB 641 E**

**PICKNICK Frischeschale '300'**  
*PICKNICK Freshness Dish '300'*



mit Porzellanschale (Ø 310 mm), Standfuß aus  
 spülmaschineneigenem Weidekorb (Kunststoff),  
 Standfußbeinsatz aus Isoliermaterial, Kühlkissen  
*with China Dish (Ø 310 mm), Base made of dishwasher  
 proof Wicker Basket (plastic), Insulated Cooling Inset,  
 Cooling Cushion*

**NFC 030 B 302** (beige)  
**NFC 030 B 303** (grau/grey)

**Maße / Dimensions:**  
 145 310 310



Anwendungsbeispiel / Example of use

**Frischeschale inkl. Haubensystem**  
*Freshness Dish incl. Hood System*  
 340 310 335

**Haubensystem '300 Schale'**  
*Hood System '300 Dish'*



Halterung aus Edelstahl, klappbar, transparente  
 Kunststoffhaube (Ø 300 mm) mit Edelstahlgriff  
*Stainless Steel Holding device, transparent  
 Plastic Hood (Ø 300 mm), with Stainless Steel Handle*  
**NB 004 E**



**Porzellanschale '300'**  
*Spare China Dish '300'*  
**3PO049**



**Haube / Deckel '300'**  
 transparente Kunststoffhaube (Ø 300 mm)  
 inkl. Edelstahlgriff  
**Hood / Lid '300'**  
 transparent Plastic Hood (Ø 300 mm)  
 incl. Stainless Steel Knob  
**EB 545 E**





**EARTH Frischeplatte '400'**  
EARTH Freshness Plate '400'

mit Porzellanplatte (∅ 410 mm),  
Standfuß aus Speckstein mit Edelstahlring,  
Standfußbeinsatz aus Isoliermaterial, Kühlkissen  
with China Plate (∅ 410 mm), Base made of  
Soapstone with Stainless Steel Hoop, Insulated  
Cooling Inset, Cooling Cushion

**NFC 000 E 401**

**Maße / Dimensions:**  
∅ 70 H 410 L 410



Anwendungsbeispiel / Example of use

**Frischeplatte inkl. Haubensystem**  
Freshness Plate incl. Hood System

∅ 335 H 410 L 435



**Haubensystem '400 Platte'**  
Hood System '400 Plate'

Halterung aus Edelstahl, klappbar, transparente  
Kunststoffhaube (∅ 400 mm) mit Edelstahlgriff  
Holding device, transparent Plastic Hood (∅ 400 mm),  
with Stainless Steel Handle

**NB 001 E**



**Porzellanplatte '400'**  
Spare China Platter '400'  
**3PO048**



**Haube / Deckel '400'**  
transparente Kunststoffhaube (∅ 400 mm)  
inkl. Edelstahlgriff  
Hood / Lid '400'  
transparent Plastic Hood (∅ 400 mm)  
incl. Stainless Steel Knob

**EB 641 E**



**EARTH Frischeschale '300'**  
EARTH Freshness Dish '300'

mit Porzellanschale (∅ 310 mm),  
Standfuß aus Speckstein mit Edelstahlring,  
Standfußbeinsatz aus Isoliermaterial, Kühlkissen  
with China Dish (∅ 310 mm), Base made of Soapstone  
with Stainless Steel Hoop, Insulated Cooling Inset,  
Cooling Cushion

**NFC 030 E 301**

**Maße / Dimensions:**  
∅ 142 H 310 L 310



Anwendungsbeispiel / Example of use

**Frischeschale inkl. Haubensystem**  
Freshness Dish incl. Hood System

∅ 340 H 310 L 335

**Porzellanschale '300'**  
Spare China Dish  
**3PO049**



**Haube / Deckel '300'**  
transparente Kunststoffhaube (∅ 300 mm)  
inkl. Edelstahlgriff  
Hood / Lid '300'  
transparent Plastic Hood (∅ 300 mm)  
incl. Stainless Steel Knob

**EB 545 E**



**Haubensystem '300 Schale'**  
Hood System '300 Dish'

Halterung aus Edelstahl, klappbar, transparente  
Kunststoffhaube (∅ 300 mm) mit Edelstahlgriff  
Stainless Steel Holding device, transparent  
Plastic Hood (∅ 300 mm), with Stainless Steel Handle

**NB 004 E**



**RAISER Buffetsystem 'Frischeplatten 33 x 33' / RAISER Buffet System 'Freshness Plates 33 x 33'**

Porzellanplatte 33 x 33 mit Kühlkissensystem\* auf Standfußrahmen aus Eichenholz  
China Plate 33 x 33 with Cooling Cushing System\* on Oak Base Frame

**S-Standfuß 'Oak' / S-Base Frame 'Oak' · Maße / Dimension: 89 H 351 L 351**



weiß / white F01.401.0000    blau / blue F01.401.0001    rot / red F01.401.0002    grau / grey F01.401.0003    caramel / caramel F01.401.0004

**L-Standfuß 'Oak' / L-Base Frame 'Oak' · Maße / Dimension: 184 H 351 L 351**



weiß / white F01.400.0000    blau / blue F01.400.0001    rot / red F01.400.0002    grau / grey F01.400.0003    caramel / caramel F01.400.0004



Porzellanplatte 33 x 33 mit Kühlkissensystem\* auf Standfußrahmen aus Fichtenholz, natur  
China Plate 33 x 33 with Cooling Cushing System\* on Spruce Base Frame

**M-Standfuß 'Spruce' / M-Base Frame 'Spruce' · Maße / Dimension: 119 H 327 L 327**



weiß / white F01.201.0000    blau / blue F01.201.0001    rot / red F01.201.0002    grau / grey F01.201.0003    caramel / caramel F01.201.0004

**L-Standfuß 'Spruce' / L-Base Frame 'Spruce' · Maße / Dimension: 184 H 327 L 327**



weiß / white F01.200.0000    blau / blue F01.200.0001    rot / red F01.200.0002    grau / grey F01.200.0003    caramel / caramel F01.200.0004



Porzellanplatte 33 x 33 mit Kühlkissensystem\* auf Standfußrahmen aus Fichtenholz 'Vintage White' in 'used look'  
China Plate 33 x 33 with Cooling Cushing System\* on Spruce Base Frame 'Vintage White' in 'used look'

**M-Standfuß 'Vintage White' / M-Base Frame 'Vintage White' · Maße / Dimension: 119 H 327 L 327**



weiß / white F01.301.0000    blau / blue F01.301.0001    rot / red F01.301.0002    grau / grey F01.301.0003    caramel / caramel F01.301.0004

**L-Standfuß 'Vintage White' / L-Base Frame 'Vintage White' · Maße / Dimension: 184 H 327 L 327**



weiß / white F01.300.0000    blau / blue F01.300.0001    rot / red F01.300.0002    grau / grey F01.300.0003    caramel / caramel F01.300.0004



**RAISER Buffetsystem Frischeplatten '33 x 33' / RAISER Buffet System 'Freshness Plates 33 x 33'**

Porzellanplatte 33 x 33 mit Kühlkissensystem\* auf Standfußrahmen aus Edelstahl  
China Plate 33 x 33 with Cooling Cushing System\* on Stainless Steel Base Frame

**S-Standfuß 'Stainless Steel' / S-Base Frame 'Stainless Steel' · Maße / Dimension: 74 H 324 L 324**



weiß / white F01.002.0000    blau / blue F01.002.0001    rot / red F01.002.0002    grau / grey F01.002.0003    caramel / caramel F01.002.0004

**M-Standfuß 'Stainless Steel' / M-Base Frame 'Stainless Steel' · Maße / Dimension: 124 H 324 L 324**



weiß / white F01.001.0000    blau / blue F01.001.0001    rot / red F01.001.0002    grau / grey F01.001.0003    caramel / caramel F01.001.0004

**L-Standfuß 'Stainless Steel' / L-Base Frame 'Stainless Steel' · Maße / Dimension: 174 H 324 L 324**



weiß / white F01.000.0000    blau / blue F01.000.0001    rot / red F01.000.0002    grau / grey F01.000.0003    caramel / caramel F01.000.0004



Porzellanplatte 33 x 33 mit Kühlkissensystem\* auf Metallstandfußrahmen (schwarz)  
China Plate 33 x 33 with Cooling Cushing System\* on Black Metal Base Frame

**S-Standfuß 'Black Steel' / S-Base Frame 'Black Steel' · Maße / Dimension: 76 H 336 L 336**



weiß / white F01.102.0000    blau / blue F01.102.0001    rot / red F01.102.0002    grau / grey F01.102.0003    caramel / caramel F01.102.0004

**M-Standfuß 'Black Steel' / M-Base Frame 'Black Steel' · Maße / Dimension: 126 H 336 L 336**



weiß / white F01.101.0000    blau / blue F01.101.0001    rot / red F01.101.0002    grau / grey F01.101.0003    caramel / caramel F01.101.0004

**L-Standfuß 'Black Steel' / L-Base Frame 'Black Steel' · Maße / Dimension: 176 H 336 L 336**



weiß / white F01.100.0000    blau / blue F01.100.0001    rot / red F01.100.0002    grau / grey F01.100.0003    caramel / caramel F01.100.0004



**RAISER Buffetsystem 'Frischeschalen 33 x 33' / RAISER Buffet System 'Freshness Dish 33 x 33'**

Porzellanschale 33 x 33 mit Kühlkissensystem\* auf Standfußrahmen aus Eichenholz  
China Bowl 33 x 33 with Cooling Cushing System\* on Oak Base Frame

**S-Standfuß 'Oak' / S-Base Frame 'Oak' · Maße / Dimension: 120 H 353 L 353**



weiß / white F02.401.0000    blau / blue F02.401.0001    rot / red F02.401.0002    grau / grey F02.401.0003    caramel / caramel F02.401.0004

**L-Standfuß 'Oak' / L-Base Frame 'Oak' · Maße / Dimension: 215 H 353 L 353**



weiß / white F02.400.0000    blau / blue F02.400.0001    rot / red F02.400.0002    grau / grey F02.400.0003    caramel / caramel F02.400.0004



Porzellanschale 33 x 33 mit Kühlkissensystem\* auf Standfußrahmen aus Fichtenholz, natur  
China Bowl 33 x 33 with Cooling Cushing System\* on Spruce Base Frame

**M-Standfuß 'Spruce' / M-Base Frame 'Spruce' · Maße / Dimension: 150 H 353 L 353**



weiß / white F02.201.0000    blau / blue F02.201.0001    rot / red F02.201.0002    grau / grey F02.201.0003    caramel / caramel F02.201.0004

**L-Standfuß 'Spruce' / L-Base Frame 'Spruce' · Maße / Dimension: 215 H 353 L 353**



weiß / white F02.200.0000    blau / blue F02.200.0001    rot / red F02.200.0002    grau / grey F02.200.0003    caramel / caramel F02.200.0004



Porzellanschale 33 x 33 mit Kühlkissensystem\* auf Standfußrahmen aus Fichtenholz 'Vintage White' in 'used look'  
China Bowl 33 x 33 with Cooling Cushing System\* on Spruce Base Frame 'Vintage White' in 'used look'

**M-Standfuß 'Vintage White' / M-Base Frame 'Vintage White' · Maße / Dimension: 150 H 353 L 353**



weiß / white F02.301.0000    blau / blue F02.301.0001    rot / red F02.301.0002    grau / grey F02.301.0003    caramel / caramel F02.301.0004

**L-Standfuß 'Vintage White' / L-Base Frame 'Vintage White' · Maße / Dimension: 215 H 353 L 353**



weiß / white F02.300.0000    blau / blue F02.300.0001    rot / red F02.300.0002    grau / grey F02.300.0003    caramel / caramel F02.300.0004



**RAISER Buffetsystem 'Frischeschalen 33 x 33' / RAISER Buffet System 'Freshness Dish 33 x 33'**

Porzellanschale 33 x 33 mit Kühlkissensystem\* auf Standfußrahmen aus Edelstahl  
China Bowl 33 x 33 with Cooling Cushing System\* on Stainless Steel Base Frame

**S-Standfuß 'Stainless Steel' / S-Base Frame 'Stainless Steel' · Maße / Dimension: 105 H 353 L 353**



weiß / white F02.002.0000    blau / blue F02.002.0001    rot / red F02.002.0002    grau / grey F02.002.0003    caramel / caramel F02.002.0004

**M-Standfuß 'Stainless Steel' / M-Base Frame 'Stainless Steel' · Maße / Dimension: 155 H 353 L 353**



weiß / white F02.001.0000    blau / blue F02.001.0001    rot / red F02.001.0002    grau / grey F02.001.0003    caramel / caramel F02.001.0004

**L-Standfuß 'Stainless Steel' / L-Base Frame 'Stainless Steel' · Maße / Dimension: 205 H 353 L 353**



weiß / white F02.000.0000    blau / blue F02.000.0001    rot / red F02.000.0002    grau / grey F02.000.0003    caramel / caramel F02.000.0004



Porzellanschale 33 x 33 mit Kühlkissensystem\* auf Metallstandfußrahmen (schwarz)  
China Bowl 33 x 33 with Cooling Cushing System\* on Black Metal Base Frame

**S-Standfuß 'Black Steel' / S-Base Frame 'Black Steel' · Maße / Dimension: 107 H 353 L 353**



weiß / white F02.102.0000    blau / blue F02.102.0001    rot / red F02.102.0002    grau / grey F02.102.0003    caramel / caramel F02.102.0004

**M-Standfuß 'Black Steel' / M-Base Frame 'Black Steel' · Maße / Dimension: 157 H 353 L 353**



weiß / white F02.101.0000    blau / blue F02.101.0001    rot / red F02.101.0002    grau / grey F02.101.0003    caramel / caramel F02.101.0004

**L-Standfuß 'Black Steel' / L-Base Frame 'Black Steel' · Maße / Dimension: 207 H 353 L 353**



weiß / white F02.100.0000    blau / blue F02.100.0001    rot / red F02.100.0002    grau / grey F02.100.0003    caramel / caramel F02.100.0004



**RAISER Buffetsystem 'Frischeplatten 23 x 23' / RAISER Buffet System 'Freshness Plates 23 x 23'**

Porzellanplatte 23 x 23 mit Kühlkissensystem\* auf Standfußrahmen aus Eichenholz  
China Plate 23 x 23 with Cooling Cushing System\* on Oak Base Frame

**S-Standfuß 'Oak' / S-Base Frame 'Oak' · Maße / Dimension: 89 H 252 L 252**



weiß / white F03.401.0000    blau / blue F03.401.0001    rot / red F03.401.0002    grau / grey F03.401.0003    caramel / caramel F03.401.0004

**L-Standfuß 'Oak' / L-Base Frame 'Spruce' · Maße / Dimension: 184 H 252 L 252**



weiß / white F03.400.0000    blau / blue F03.400.0001    rot / red F03.400.0002    grau / grey F03.400.0003    caramel / caramel F03.400.0004



Porzellanplatte 23 x 23 mit Kühlkissensystem\* auf Standfußrahmen aus Fichtenholz, natur  
China Plate 23 x 23 with Cooling Cushing System\* on Spruce Base Frame

**M-Standfuß 'Spruce' / M-Base Frame 'Spruce' · Maße / Dimension: 119 H 230 L 230**



weiß / white F03.201.0000    blau / blue F03.201.0001    rot / red F03.201.0002    grau / grey F03.201.0003    caramel / caramel F03.201.0004

**L-Standfuß 'Spruce' / L-Base Frame 'Spruce' · Maße / Dimension: 184 H 230 L 230**



weiß / white F03.200.0000    blau / blue F03.200.0001    rot / red F03.200.0002    grau / grey F03.200.0003    caramel / caramel F03.200.0004



Porzellanplatte 23 x 23 mit Kühlkissensystem\* auf Standfußrahmen aus Fichtenholz 'Vintage White' in 'used look'  
China Plate 23 x 23 with Cooling Cushing System\* on Spruce Base Frame 'Vintage White' in 'used look'

**M-Standfuß 'Vintage White' / M-Base Frame 'Vintage White' · Maße / Dimension: 119 H 230 L 230**



weiß / white F03.301.0000    blau / blue F03.301.0001    rot / red F03.301.0002    grau / grey F03.301.0003    caramel / caramel F03.301.0004

**L-Standfuß 'Vintage White' / L-Base Frame 'Vintage White' · Maße / Dimension: 184 H 230 L 230**



weiß / white F03.300.0000    blau / blue F03.300.0001    rot / red F03.300.0002    grau / grey F03.300.0003    caramel / caramel F03.300.0004



! Einzelteile zu diesen Artikeln Seite 106/107  
Spare Parts for these articles page 106/107

\*Kunststoffeinsatz mit Kühlkissen unterhalb der Porzellanplatte  
Plastic Insert with Cooling Cushion below China Plate

**RAISER Buffetsystem 'Frischeplatten 23 x 23' / RAISER Buffet System 'Freshness Plates 23 x 23'**

Porzellanplatte 23 x 23 mit Kühlkissensystem\* auf Standfußrahmen aus Edelstahl  
China Plate 23 x 23 with Cooling Cushing System\* on Stainless Steel Base Frame

**S-Standfuß 'Stainless Steel' / S-Base Frame 'Stainless Steel' · Maße / Dimension: 74 H 230 L 230**



weiß / white F03.002.0000    blau / blue F03.002.0001    rot / red F03.002.0002    grau / grey F03.002.0003    caramel / caramel F03.002.0004

**M-Standfuß 'Stainless Steel' / M-Base Frame 'Stainless Steel' · Maße / Dimension: 124 H 230 L 230**



weiß / white F03.001.0000    blau / blue F03.001.0001    rot / red F03.001.0002    grau / grey F03.001.0003    caramel / caramel F03.001.0004

**L-Standfuß 'Stainless Steel' / L-Base Frame 'Stainless Steel' · Maße / Dimension: 174 H 230 L 230**



weiß / white F03.000.0000    blau / blue F03.000.0001    rot / red F03.000.0002    grau / grey F03.000.0003    caramel / caramel F03.000.0004



Porzellanplatte 23 x 23 mit Kühlkissensystem\* auf Metallstandfußrahmen (schwarz) / China Plate 23 x 23 with Cooling Cushing System\* on Black Metal Base Frame

**S-Standfuß 'Black Steel' / S-Base Frame 'Black Steel' · Maße / Dimension: 76 H 230 L 230**



weiß / white F03.102.0000    blau / blue F03.102.0001    rot / red F03.102.0002    grau / grey F03.102.0003    caramel / caramel F03.102.0004

**M-Standfuß 'Black Steel' / M-Base Frame 'Black Steel' · Maße / Dimension: 126 H 230 L 230**



weiß / white F03.101.0000    blau / blue F03.101.0001    rot / red F03.101.0002    grau / grey F03.101.0003    caramel / caramel F03.101.0004

**L-Standfuß 'Black Steel' / L-Base Frame 'Black Steel' · Maße / Dimension: 176 H 230 L 230**



weiß / white F03.100.0000    blau / blue F03.100.0001    rot / red F03.100.0002    grau / grey F03.100.0003    caramel / caramel F03.100.0004



! Einzelteile zu diesen Artikeln Seite 106/107  
Spare Parts for these articles page 106/107

\*Kunststoffeinsatz mit Kühlkissen unterhalb der Porzellanplatte  
Plastic Insert with Cooling Cushion below China Plate



**RAISER Buffetsystem 'Frischeschalen 23 x 23' / RAISER Buffet System 'Freshness Dish 23 x 23'**

Porzellanschale 23 x 23 mit Kühlkissensystem\* auf Standfußrahmen aus Eichenholz  
China Bowl 23 x 23 with Cooling Cushing System\* on Oak Base Frame

**S-Standfuß 'Oak' / S-Base Frame 'Oak' · Maße / Dimension: 140 254 254**



weiß / white  
F04.401.0000

blau / blue  
F04.401.0001

rot / red  
F04.401.0002

grau / grey  
F04.401.0003

caramel / caramel  
F04.401.0004

**L-Standfuß 'Oak' / L-Base Frame 'Oak' · Maße / Dimension: 235 254 254**



weiß / white  
F04.400.0000

blau / blue  
F04.400.0001

rot / red  
F04.400.0002

grau / grey  
F04.400.0003

caramel / caramel  
F04.400.0004



Porzellanschale 23 x 23 mit Kühlkissensystem\* auf Standfußrahmen aus Fichtenholz  
China Bowl 23 x 23 with Cooling Cushing System\* on Spruce Base Frame

**M-Standfuß 'Spruce' / M-Base Frame 'Spruce' · Maße / Dimension: 170 254 254**



weiß / white  
F04.201.0000

blau / blue  
F04.201.0001

rot / red  
F04.201.0002

grau / grey  
F04.201.0003

caramel / caramel  
F04.201.0004

**L-Standfuß 'Spruce' / L-Base Frame 'Spruce' · Maße / Dimension: 235 254 254**



weiß / white  
F04.200.0000

blau / blue  
F04.200.0001

rot / red  
F04.200.0002

grau / grey  
F04.200.0003

caramel / caramel  
F04.200.0004



Porzellanschale 23 x 23 mit Kühlkissensystem\* auf Standfußrahmen aus Fichtenholz 'Vintage White' in 'used look'  
China Bowl 23 x 23 with Cooling Cushing System\* on Spruce Base Frame 'Vintage White' in 'used look'

**M-Standfuß 'Vintage White' / M-Base Frame 'Vintage White' · Maße / Dimension: 170 254 254**



weiß / white  
F04.301.0000

blau / blue  
F04.301.0001

rot / red  
F04.301.0002

grau / grey  
F04.301.0003

caramel / caramel  
F04.301.0004

**L-Standfuß 'Vintage White' / L-Base Frame 'Vintage White' · Maße / Dimension: 235 254 254**



weiß / white  
F04.300.0000

blau / blue  
F04.300.0001

rot / red  
F04.300.0002

grau / grey  
F04.300.0003

caramel / caramel  
F04.300.0004



**RAISER Buffetsystem 'Frischeschalen 23 x 23' / RAISER Buffet System 'Freshness Dish 23 x 23'**

Porzellanschale 23 x 23 mit Kühlkissensystem\* auf Standfußrahmen aus Edelstahl  
China Bowl 23 x 23 with Cooling Cushing System\* on Stainless Steel Base Frame

**S-Standfuß 'Stainless Steel' / S-Base Frame 'Stainless Steel' · Maße / Dimension: 125 254 254**



weiß / white  
F04.002.0000

blau / blue  
F04.002.0001

rot / red  
F04.002.0002

grau / grey  
F04.002.0003

caramel / caramel  
F04.002.0004

**M-Standfuß 'Stainless Steel' / M-Base Frame 'Stainless Steel' · Maße / Dimension: 175 254 254**



weiß / white  
F04.001.0000

blau / blue  
F04.001.0001

rot / red  
F04.001.0002

grau / grey  
F04.001.0003

caramel / caramel  
F04.001.0004

**L-Standfuß 'Stainless Steel' / L-Base Frame 'Stainless Steel' · Maße / Dimension: 225 254 254**



weiß / white  
F04.000.0000

blau / blue  
F04.000.0001

rot / red  
F04.000.0002

grau / grey  
F04.000.0003

caramel / caramel  
F04.000.0004



Porzellanschale 23 x 23 mit Kühlkissensystem\* auf Metallstandfußrahmen (schwarz)  
China Bowl 23 x 23 with Cooling Cushing\* on Black Metal Base Frame

**S-Standfuß 'Black Steel' / S-Base Frame 'Black Steel' · Maße / Dimension: 127 254 254**



weiß / white  
F04.102.0000

blau / blue  
F04.102.0001

rot / red  
F04.102.0002

grau / grey  
F04.102.0003

caramel / caramel  
F04.102.0004

**M-Standfuß 'Black Steel' / M-Base Frame 'Black Steel' · Maße / Dimension: 177 254 254**



weiß / white  
F04.101.0000

blau / blue  
F04.101.0001

rot / red  
F04.101.0002

grau / grey  
F04.101.0003

caramel / caramel  
F04.101.0004

**L-Standfuß 'Black Steel' / L-Base Frame 'Black Steel' · Maße / Dimension: 227 254 254**



weiß / white  
F04.100.0000

blau / blue  
F04.100.0001

rot / red  
F04.100.0002

grau / grey  
F04.100.0003

caramel / caramel  
F04.100.0004



**RAISER Buffetsystem 'Buffetschale 23 x 23' / RAISER Buffet System 'Buffet Bowl 23 x 23'**

Schräge Porzellanschale 23 x 23 (Ø 280mm) mit Kühlkissensystem\* auf Standfußrahmen aus Eichenholz  
Slope China Bowl 23 x 23 (Ø 280mm) with Cooling Cushing System\* on Oak Base Frame

**S-Standfuß 'Oak' / S-Base Frame 'Oak' · Maße / Dimension:** 190 H 280 L 280



|                              |                             |                           |                             |                                   |
|------------------------------|-----------------------------|---------------------------|-----------------------------|-----------------------------------|
|                              |                             |                           |                             |                                   |
| weiß / white<br>F05.401.0000 | blau / blue<br>F05.401.0001 | rot / red<br>F05.401.0002 | grau / grey<br>F05.401.0003 | caramel / caramel<br>F05.401.0004 |

**L-Standfuß 'Oak' / L-Base Frame 'Oak' · Maße / Dimension:** 285 H 280 L 280



|                              |                             |                           |                             |                                   |
|------------------------------|-----------------------------|---------------------------|-----------------------------|-----------------------------------|
|                              |                             |                           |                             |                                   |
| weiß / white<br>F05.400.0000 | blau / blue<br>F05.400.0001 | rot / red<br>F05.400.0002 | grau / grey<br>F05.400.0003 | caramel / caramel<br>F05.400.0004 |



**RAISER Buffetsystem 'Buffetschale 23 x 23' / RAISER Buffet System 'Buffet Bowl 23 x 23'**

Schräge Porzellanschale 23 x 23 (Ø 280mm) mit Kühlkissensystem\* auf Standfußrahmen aus Edelstahl  
Slope China Bowl 23 x 23 (Ø 280mm) with Cooling Cushing System\* on Stainless Steel Base Frame

**S-Standfuß 'Stainless Steel' / S-Base Frame 'Stainless Steel' · Maße / Dimension:** 175 H 280 L 280



|                              |                             |                           |                             |                                   |
|------------------------------|-----------------------------|---------------------------|-----------------------------|-----------------------------------|
|                              |                             |                           |                             |                                   |
| weiß / white<br>F05.002.0000 | blau / blue<br>F05.002.0001 | rot / red<br>F05.002.0002 | grau / grey<br>F05.002.0003 | caramel / caramel<br>F05.002.0004 |

**M-Standfuß 'Stainless Steel' / M-Base Frame 'Stainless Steel' · Maße / Dimension:** 225 H 280 L 280



|                              |                             |                           |                             |                                   |
|------------------------------|-----------------------------|---------------------------|-----------------------------|-----------------------------------|
|                              |                             |                           |                             |                                   |
| weiß / white<br>F05.001.0000 | blau / blue<br>F05.001.0001 | rot / red<br>F05.001.0002 | grau / grey<br>F05.001.0003 | caramel / caramel<br>F05.001.0004 |

**L-Standfuß 'Stainless Steel' / L-Base Frame 'Stainless Steel' · Maße / Dimension:** 275 H 280 L 280



|                              |                             |                           |                             |                                   |
|------------------------------|-----------------------------|---------------------------|-----------------------------|-----------------------------------|
|                              |                             |                           |                             |                                   |
| weiß / white<br>F05.000.0000 | blau / blue<br>F05.000.0001 | rot / red<br>F05.000.0002 | grau / grey<br>F05.000.0003 | caramel / caramel<br>F05.000.0004 |



Schräge Porzellanschale 23 x 23 (Ø 280mm) mit Kühlkissensystem\* auf Standfußrahmen aus Fichtenholz, natur  
Slope China Bowl 23 x 23 (Ø 280mm) with Cooling Cushing System\* on Spruce Base Frame

**M-Standfuß 'Spruce' / M-Base Frame 'Spruce' · Maße / Dimension:** 220 H 280 L 280



|                              |                             |                           |                             |                                   |
|------------------------------|-----------------------------|---------------------------|-----------------------------|-----------------------------------|
|                              |                             |                           |                             |                                   |
| weiß / white<br>F05.201.0000 | blau / blue<br>F05.201.0001 | rot / red<br>F05.201.0002 | grau / grey<br>F05.201.0003 | caramel / caramel<br>F05.201.0004 |

**L-Standfuß 'Spruce' / L-Base Frame 'Spruce' · Maße / Dimension:** 285 H 280 L 280



|                              |                             |                           |                             |                                   |
|------------------------------|-----------------------------|---------------------------|-----------------------------|-----------------------------------|
|                              |                             |                           |                             |                                   |
| weiß / white<br>F05.200.0000 | blau / blue<br>F05.200.0001 | rot / red<br>F05.200.0002 | grau / grey<br>F05.200.0003 | caramel / caramel<br>F05.200.0004 |



Schräge Porzellanschale 23 x 23 (Ø 280mm) mit Kühlkissensystem\* auf Metallstandfußrahmen (schwarz)  
Slope China Bowl 23 x 23 (Ø 280mm) with Cooling Cushing System\* on Black Metal Base Frame

**S-Standfuß 'Black Steel' / S-Base Frame 'Black Steel' · Maße / Dimension:** 177 H 280 L 280



|                              |                             |                           |                             |                                   |
|------------------------------|-----------------------------|---------------------------|-----------------------------|-----------------------------------|
|                              |                             |                           |                             |                                   |
| weiß / white<br>F05.102.0000 | blau / blue<br>F05.102.0001 | rot / red<br>F05.102.0002 | grau / grey<br>F05.102.0003 | caramel / caramel<br>F05.102.0004 |

**M-Standfuß 'Black Steel' / M-Base Frame 'Black Steel' · Maße / Dimension:** 227 H 280 L 280



|                              |                             |                           |                             |                                   |
|------------------------------|-----------------------------|---------------------------|-----------------------------|-----------------------------------|
|                              |                             |                           |                             |                                   |
| weiß / white<br>F05.101.0000 | blau / blue<br>F05.101.0001 | rot / red<br>F05.101.0002 | grau / grey<br>F05.101.0003 | caramel / caramel<br>F05.101.0004 |

**L-Standfuß 'Black Steel' / L-Base Frame 'Black Steel' · Maße / Dimension:** 277 H 280 L 280



|                              |                             |                           |                             |                                   |
|------------------------------|-----------------------------|---------------------------|-----------------------------|-----------------------------------|
|                              |                             |                           |                             |                                   |
| weiß / white<br>F05.100.0000 | blau / blue<br>F05.100.0001 | rot / red<br>F05.100.0002 | grau / grey<br>F05.100.0003 | caramel / caramel<br>F05.100.0004 |



Schräge Porzellanschale 23 x 23 (Ø 280mm) mit Kühlkissensystem\* auf Standfußrahmen aus Fichtenholz  
'Vintage White' in 'used look'  
Slope China Bowl 23 x 23 (Ø 280mm) with Cooling Cushing System\* on Spruce Base Frame 'Vintage White' in 'used look'

**M-Standfuß 'Vintage White' / M-Base Frame 'Vintage White' · Maße / Dimension:** 220 H 228 L 228



|                              |                             |                           |                             |                                   |
|------------------------------|-----------------------------|---------------------------|-----------------------------|-----------------------------------|
|                              |                             |                           |                             |                                   |
| weiß / white<br>F05.301.0000 | blau / blue<br>F05.301.0001 | rot / red<br>F05.301.0002 | grau / grey<br>F05.301.0003 | caramel / caramel<br>F05.301.0004 |

**L-Standfuß 'Vintage White' / L-Base Frame 'Vintage White' · Maße / Dimension:** 285 H 228 L 228



|                              |                             |                           |                             |                                   |
|------------------------------|-----------------------------|---------------------------|-----------------------------|-----------------------------------|
|                              |                             |                           |                             |                                   |
| weiß / white<br>F05.300.0000 | blau / blue<br>F05.300.0001 | rot / red<br>F05.300.0002 | grau / grey<br>F05.300.0003 | caramel / caramel<br>F05.300.0004 |



**RAISER Buffetsystem 'Rundplatte 23 x 23' / RAISER Buffet System 'Round Plate 23 x 23'**

Runde Porzellanplatte 23 x 23 (Ø 230mm) mit Kunststoffhaube spülmaschinene geeignet und Kühlkissensystem\* auf Standfußrahmen aus Eichenholz  
 Round China Plate 23 x 23 (Ø 230mm) with Plastic Hood suitable for dishwasher use and Cooling Cushion System\* on Oak Base Frame

**S-Standfuß 'Oak' / S-Base Frame 'Oak' · Maße / Dimension: 223 H 252 L 252**



weiß / white  
F06.401.0000

blau / blue  
F06.401.0001

rot / red  
F06.401.0002

grau / grey  
F06.401.0003

caramel / caramel  
F06.401.0004

**L-Standfuß 'Oak' / L-Base Frame 'Oak' · Maße / Dimension: 318 H 252 L 252**



weiß / white  
F06.400.0000

blau / blue  
F06.400.0001

rot / red  
F06.400.0002

grau / grey  
F06.400.0003

caramel / caramel  
F06.400.0004



Runde Porzellanplatte 23 x 23 (Ø 230mm) mit Kunststoffhaube spülmaschinene geeignet und Kühlkissensystem\* auf Standfußrahmen aus Fichtenholz, natur  
 Round China Plate 23 x 23 (Ø 230mm) with Plastic Hood suitable for dishwasher use and Cooling Cushion System\* on Spruce Base Frame

**M-Standfuß 'Spruce' / M-Base Frame 'Spruce' · Maße / Dimension: 253 H 230 L 230**



weiß / white  
F06.201.0000

blau / blue  
F06.201.0001

rot / red  
F06.201.0002

grau / grey  
F06.201.0003

caramel / caramel  
F06.201.0004

**L-Standfuß 'Spruce' / L-Base Frame 'Spruce' · Maße / Dimension: 318 H 230 L 230**



weiß / white  
F06.200.0000

blau / blue  
F06.200.0001

rot / red  
F06.200.0002

grau / grey  
F06.200.0003

caramel / caramel  
F06.200.0004



Runde Porzellanplatte 23 x 23 (Ø 230mm) mit Kunststoffhaube spülmaschinene geeignet und Kühlkissensystem\* auf Standfußrahmen aus Fichtenholz 'Vintage White' in 'used look'  
 Round China Plate 23 x 23 (Ø 230mm) with Plastic Hood suitable for dishwasher use and Cooling Cushion System\* on Spruce Base Frame 'Vintage White' in 'used look'

**M-Standfuß 'Vintage White' / M-Base Frame 'Vintage White' · Maße / Dimension: 253 H 230 L 230**



weiß / white  
F06.301.0000

blau / blue  
F06.301.0001

rot / red  
F06.301.0002

grau / grey  
F06.301.0003

caramel / caramel  
F06.301.0004

**L-Standfuß 'Vintage White' / L-Base Frame 'Vintage White' · Maße / Dimension: 318 H 230 L 230**



weiß / white  
F06.300.0000

blau / blue  
F06.300.0001

rot / red  
F06.300.0002

grau / grey  
F06.300.0003

caramel / caramel  
F06.300.0004



**RAISER Buffetsystem 'Rundplatte 23 x 23' / RAISER Buffet System 'Round Plate 23 x 23'**

Runde Porzellanplatte 23 x 23 (Ø 230mm) mit Kunststoffhaube spülmaschinene geeignet und Kühlkissensystem\* auf Standfußrahmen aus Edelstahl  
 Round China Plate 23 x 23 (Ø 230mm) with Plastic Hood suitable for dishwasher use and Cooling Cushion System\* on Stainless Steel Base Frame

**S-Standfuß 'Stainless Steel' / S-Base Frame 'Stainless Steel' · Maße / Dimension: 208 H 230 L 230**



weiß / white  
F06.002.0000

blau / blue  
F06.002.0001

rot / red  
F06.002.0002

grau / grey  
F06.002.0003

caramel / caramel  
F06.002.0004

**M-Standfuß 'Stainless Steel' / M-Base Frame 'Stainless Steel' · Maße / Dimension: 258 H 230 L 230**



weiß / white  
F06.001.0000

blau / blue  
F06.001.0001

rot / red  
F06.001.0002

grau / grey  
F06.001.0003

caramel / caramel  
F06.001.0004

**L-Standfuß 'Stainless Steel' / L-Base Frame 'Stainless Steel' · Maße / Dimension: 308 H 230 L 230**



weiß / white  
F06.000.0000

blau / blue  
F06.000.0001

rot / red  
F06.000.0002

grau / grey  
F06.000.0003

caramel / caramel  
F06.000.0004



Runde Porzellanplatte 23 x 23 (Ø 230mm) mit Kunststoffhaube spülmaschinene geeignet und Kühlkissensystem\* auf Metallstandfußrahmen (schwarz)  
 Round China Plate 23 x 23 (Ø 230mm) with Plastic Hood suitable for dishwasher use and Cooling Cushion System\* on Black Metal Base Frame

**S-Standfuß 'Black Steel' / S-Base Frame 'Black Steel' · Maße / Dimension: 210 H 230 L 230**



weiß / white  
F06.102.0000

blau / blue  
F06.102.0001

rot / red  
F06.102.0002

grau / grey  
F06.102.0003

caramel / caramel  
F06.102.0004

**M-Standfuß 'Black Steel' / M-Base Frame 'Black Steel' · Maße / Dimension: 260 H 230 L 230**



weiß / white  
F06.101.0000

blau / blue  
F06.101.0001

rot / red  
F06.101.0002

grau / grey  
F06.101.0003

caramel / caramel  
F06.101.0004

**L-Standfuß 'Black Steel' / L-Base Frame 'Black Steel' · Maße / Dimension: 310 H 230 L 230**



weiß / white  
F06.100.0000

blau / blue  
F06.100.0001

rot / red  
F06.100.0002

grau / grey  
F06.100.0003

caramel / caramel  
F06.100.0004



**Rolltophaube 'GN'**  
Rolltop Cover 'GN'



**Rolltop-Haube mit Griff 1/1 'GN'**  
Rolltop Hood with knob 1/1 'GN'  
**10078**    Edelstahl / St. St.

**Maße / Dimensions:**  
☒ 240 ☒ 550 ☒ 350



Anwendungsbeispiel  
Example of use

**Hygieneschutz 'GN'**  
Hygienic Cover 'GN'



**EB 702 E**  
**Maße / Dimensions:**  
☒ 390 ☒ 650 ☒ 420



Anwendungsbeispiel  
Example of use



**RAISER Porzellanplatten GN**  
RAISER China Plates GN



**1/1**  
**Maße / Dimensions:** ☒ 16 ☒ 530 ☒ 325



**1/2**  
**Maße / Dimensions:** ☒ 16 ☒ 265 ☒ 325



**1/3**  
**Maße / Dimensions:** ☒ 16 ☒ 175 ☒ 325



**2/4**  
**Maße / Dimensions:** ☒ 16 ☒ 530 ☒ 160

**Vollplatte 1/1 GN / Full Size Plate 1/1 GN**

**weiß / white**            **3PO099**  
**blau / blue**             **3PO100**  
**rot / red**                **3PO124**  
**grau / grey**            **3PO102**  
**caramel / caramel**    **3PO103**

**Maße / Dimensions:** ☒ 16 ☒ 530 ☒ 325

**Teilplatte 1/2 GN / Part Size Plate 1/2 GN**

**weiß / white**            **3PO104**  
**blau / blue**             **3PO105**  
**rot / red**                **3PO125**  
**grau / grey**            **3PO107**  
**caramel / caramel**    **3PO108**

**Maße / Dimensions:** ☒ 16 ☒ 265 ☒ 325

**Vollplatte 1/3 GN / Part Size Plate 1/3 GN**

**weiß / white**            **3PO109**  
**blau / blue**             **3PO110**  
**rot / red**                **3PO126**  
**grau / grey**            **3PO112**  
**caramel / caramel**    **3PO113**

**Maße / Dimensions:** ☒ 16 ☒ 175 ☒ 325

**Vollplatte 2/4 GN / Part Size Plate 2/4 GN**

**weiß / white**            **3PO114**  
**blau / blue**             **3PO115**  
**rot / red**                **3PO127**  
**grau / grey**            **3PO117**  
**caramel / caramel**    **3PO118**

**Maße / Dimensions:** ☒ 16 ☒ 530 ☒ 160

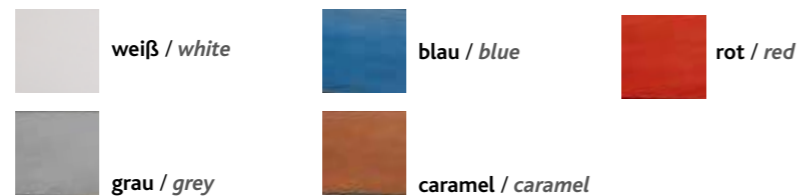

**RAISER Buffetsystem 'Frischeplatte GN'**  
RAISER Buffetsystem 'Freshness Plate GN'

Standfußrahmen aus Holz mit Kunststoffeinsatz und zwei Kühlkissen. Mit Rolltop-Haube bzw. Hygieneschutz ausstattbar (siehe Seite 68). Einsatz verschiedener GN-Porzellanplatten. Bitte separat bestellen!  
Wooden Base-Frame with Plastic Insert and two Cooling Cushions. Can be equipped with Rolltop-Hood and Hygienic Cover (see page 68). Use with several GN China Plate options. Please order separately!



**Standfuß GN 'Natur', unbehandelt**  
Wooden Base Frame GN 'Spruce' untreated  
**RB 649 H**

**Standfuß GN 'Vintage White'**  
Wooden Base Frame GN 'Vintage White'  
**RB 649 H 001**

**Maße / Dimensions:**  
☒ 55 ☒ 555 ☒ 350



Anwendungsbeispiel / Example of use

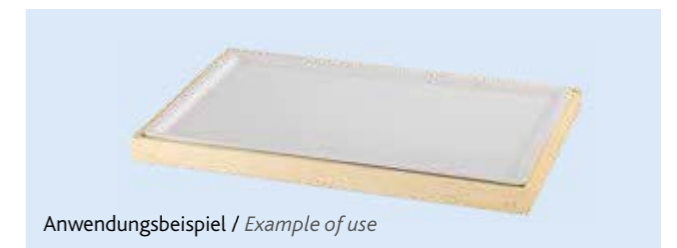

Anwendungsbeispiel / Example of use

**UNISON Etagere 'GN'**  
*UNISON Display Stand 'GN'*

Mit der praktischen Etagere werden Frisch Frischeplatten im GN-Format platzsparend auf zwei Ebenen platziert.  
Auch für den Einsatz der Brotplatte (s. Seite 95) geeignet  
*With the convenient display stand for food service trays in 1/1 GN size can be placed on two tiers.  
Also suitable for the use of Bread Tray (page 95)*

**AB 513**  
Edelstahl / Stainless Steel

**Maße / Dimensions:**  
☞ 505 ☞ 635 ☞ 305



Anwendungsbeispiel / Example of use



**UNISON Rolltop-Haube 'GN'**  
*UNISON Rolltop Hood 'GN'*



**mit Griff 1/1 GN**  
*with knob 1/1 GN*  
**10078** Edelstahl / St. St.  
**10079** Gold / Gold

**Maße / Dimensions:**  
☞ 240 ☞ 550 ☞ 350

! Bei Bedarf Rolltop-Haube oder Hygieneschutz extra bestellen!  
*Rolltop Hood or Hygienic Cover must be ordered separately!*



Anwendungsbeispiel  
Example of use

**UNISON Hygieneschutz 'GN'**  
*UNISON Hygienic Cover 'GN'*



**EB 702 E**  
**Maße / Dimensions:**  
☞ 390 ☞ 650 ☞ 420

! Bei Bedarf Rolltop-Haube oder Hygieneschutz extra bestellen!  
*Rolltop Hood or Hygienic Cover must be ordered separately!*



Anwendungsbeispiel  
Example of use

**UNISON Frischeplatte 'GN'**  
*UNISON Freshness Plate 'GN'*

GN Edelstahl-Standfuß mit Kunststoffeinsatz sowie Kühlkissen. GN Porzellanplatten in verschiedenen Größen.  
*GN Stainless Steel Base with plastic insert and cooling cushions. GN China Plates in different sizes.*

mit Porzellanplatte 1/1 GN / *with china plate 1/1 GN*

**EFC 000 E 019** Edelstahl / St. St.  
**EFC 000 G 019** Gold 24 Karat / Gold 24 Carat

**Maße / Dimensions:**  
☞ 55 ☞ 550 ☞ 345

mit 2 Porzellanplatten 1/2 GN / *with 2 china plates 1/2 GN*

**EFC 000 E 020** Edelstahl / St. St.  
**EFC 000 G 020** Gold 24 Karat / Gold 24 Carat

**Maße / Dimensions:**  
☞ 55 ☞ 550 ☞ 345

mit 3 Porzellanplatten 1/3 GN / *with 3 china plates 1/3 GN*

**EFC 000 E 021** Edelstahl / St. St.  
**EFC 000 G 021** Gold 24 Karat / Gold 24 Carat

**Maße / Dimensions:**  
☞ 55 ☞ 550 ☞ 345



**Ersatz-Porzellanplatte 1/1 GN**  
*Spare China Plate 1/1 GN*  
**3PO001**

**Maße / Dimensions:**  
☞ 12 ☞ 520 ☞ 325



**Ersatz-Porzellanplatte 1/2 GN**  
*Spare China Plate 1/2 GN*  
**3PO003**

**Maße / Dimensions:**  
☞ 12 ☞ 265 ☞ 325



**Ersatz-Porzellanplatte 1/3 GN**  
*Spare China Plate 1/3 GN*  
**3PO004**

**Maße / Dimensions:**  
☞ 12 ☞ 175 ☞ 325



**UNISON Etagere 'Rund'**  
**UNISON Display Stand 'Round'**

Mit der praktischen Etage werden alle Frischschalen und Frischeplatten im Rundformat platzsparend auf zwei Ebenen platziert. Aus eloxiertem Aluminium mit Fixierungsvorrichtung für die obere Schale/Platte.  
*With the convenient display stand all round freshness dishes and plates can be placed on two tiers. It is made of anodised aluminium with fixation device for the dish/plate in the upper tier.*

**EB 630 E**  
Edelstahl / Stainless Steel

**Maße / Dimensions:**  
☒ 415 ☒ 490 ☒ 410



Anwendungsbeispiel / Example of use



**UNISON Hygieneschutz '400' bzw. '300'**  
**UNISON Hygienic Cover '400' resp. '300'**

Hygieneschutz für '300'

**EB 700 E**

**Maße / Dimensions:** ☒ 390 ☒ 370 ☒ 420

Hygieneschutz für '400'

**EB 701 E**

**Maße / Dimensions:** ☒ 390 ☒ 470 ☒ 420



Anwendungsbeispiel  
Example of use



**UNISON Aufstellhaube '300'**  
**UNISON Set-Up-Hood '300'**

Abdeckhaube mit Griff (Ø 300 mm), inkl. Aufstellarm  
*Cover Hood with knob (Ø 300 mm), incl. Hinged Hood Device*

**EB 543 E** Edelstahl / St. St.  
**EB 543 G** Gold / Gold

**Maße / Dimensions:**  
Ø 300 ☒ 260



Anwendungsbeispiel  
Example of use

Beispiel: Wurst- / Käse-Station  
Example: Cold Cut Station



**UNISON Frischeplatte '300'**  
**UNISON Freshness Plate '300'**

Edelstahl-Standfuß mit Kunststoffeinsatz sowie Kühlkissen zum Kühlen der Porzellan-Rundplatte  
*Stainless Steel Base with plastic insert and cooling cushions with circular china plate*

**EFC 000 E 018** Edelstahl / St. St.  
**EFC 000 G 018** Gold 24 Karat / Gold 24 Carat

**Maße / Dimensions:**  
Ø 305 ☒ 45



**Ersatz-Porzellanplatte 300**  
**Spare China Plate 300**  
**3PO006**

**Maße / Dimensions:**  
☒ 12 ☒ 300 ☒ 300



**UNISON Rolltop-Haube '400'**  
**UNISON Rolltop Hood '400'**

Rolltop-Haube mit Griff (Ø 400 mm)  
*Rolltop-Hood with knob (Ø 400 mm)*

**EB 546 E** Edelstahl / St. St.  
**EB 546 G** Gold / Gold

**Maße / Dimensions:**  
Ø 400 ☒ 200



Anwendungsbeispiel  
Example of use

**UNISON Frischeplatte '400'**  
**UNISON Freshness Plate '400'**

Edelstahl-Standfuß mit Kunststoffeinsatz sowie Kühlkissen zum Kühlen der Porzellan-Rundplatte  
*Stainless Steel Base with plastic insert and cooling cushions with circular china plate*

**EFC 000 E 405** Edelstahl / St. St.  
**EFC 000 G 405** Gold 24 Karat / Gold 24 Carat

**Maße / Dimensions:**  
Ø 410 ☒ 50



**Ersatz-Porzellanplatte 400**  
**Spare China Plate 400**  
**3PO005**

**Maße / Dimensions:**  
☒ 12 ☒ 400 ☒ 400



**ELEGANCE Butterschale, 2,5 Liter**  
*ELEGANCE Butter Dish, 2.5 Liters*

**2,5 Liter / 2.5 Liters**

Kunststoffring, Einlegeplatte aus Edelstahl, Kühlakku, Standfuß, Deckel mit Deckelgriff aus Edelstahl

*Plastic-Ring, insert plate made of Stainless steel, cooling pack, Base and lid incl. knob made of Stainless Steel*

**EBC 025 E 001** Edelstahl / *Stainless Steel*

**EBC 025 G 001** Gold 24 Karat / *Gold 24 Carat*

**Maße / Dimensions:**

Ø 185 H 225



**Butterschalenring (2,5 Liter)**

*Plastic Ring for Butter Dish (2.5 liters)*

**3SA031**



**Butterschalenring (1,5 Liter)**

*Plastic Ring for Butter Dish (1.5 liters)*

**3SA030**



**1,5 Liter / 1.5 Liters**

Kunststoffring, Einlegeplatte aus Edelstahl, Kühlakku, Standfuß, Deckel mit Deckelgriff aus Edelstahl

*Plastic-Ring, insert plate made of Stainless steel, cooling pack, Base and lid incl. knob made of Stainless Steel*

**EBC 015 E 002** Edelstahl / *Stainless Steel*

**EBC 015 G 002** Gold 24 Karat / *Gold 24 Carat*

**Maße / Dimensions:**

Ø 185 H 185



**ELEGANCE Frischeschale, 2,5 Liter**  
*ELEGANCE Freshness Dish, 2.5 Liters*

**2,5 Liter / 2.5 Liters**

Kunststoffschale, Kühlakku, Standfuß und Deckel mit Deckelgriff aus Edelstahl

*Plastic dish, cooling pack, Base and lid incl. knob made of stainless steel*

**EFC 025 E 001** Edelstahl / *St. St.*

**EFC 025 G 001** Gold 24 Karat / *Gold 24 Carat*

**Maße / Dimensions:**

Ø 185 H 225



**Kunststoffschale (2,5 Liter)**

*Plastic Dish (2.5 liters)*

**3SA029**



**1,5 Liter / 1.5 Liters**

Kunststoffschale, Kühlakku, Standfuß und Deckel mit Deckelgriff aus Edelstahl

*Plastic dish, cooling pack, Base and lid incl. knob made of stainless steel*

**EFC 015 E 002** Edelstahl / *St. St.*

**EFC 015 G 002** Gold 24 Karat / *Gold 24 Carat*

**Maße / Dimensions:**

Ø 185 H 185



**Kunststoffschale (1,5 Liter)**

*Plastic Dish (1.5 liters)*

**3SA028**



**UNISON Frischeschale '280'**  
*UNISON Freshness Dish '280'*

Edelstahl-Standfuß mit Kühlkissen und Porzellanschale

*Stainless Steel Base with Cooling Cushion and china bowl*

**EFC 000 E 014** Edelstahl / *St. St.*

**EFC 000 G 014** Gold 24 Karat / *Gold 24 Carat*

**Maße / Dimensions:**

Ø 285 H 140



Bei Bedarf Haube inkl. Haubenhalter extra bestellen.  
*Hood incl. Hood holder must be ordered separately.*



**Porzellanschale (Ø 280 mm)**

*Spare China Bowl (Ø 280 mm)*

**3PO008**

Optional/optional:



**Haube inkl. Haubenhalter**

*Hood incl. Hood holder*

**EB 578 E** Edelstahl / *St. St.*

**EB 578 G** Gold / *Gold*



**Haube / Hood**

**EB 571 E** Edelstahl / *St. St.*

**EB 571 G** Gold / *Gold*



**UNISON Frischeplatte '230'**  
*UNISON Freshness Plate '230'*

Edelstahl-Standfuß mit Kühlkissen und Porzellan-Rundplatte, Abdeckhaube

*Stainless Steel Base with Cooling Cushion and circular china platter, cover hood*

**EFC 000 E 016** Edelstahl / *St. St.*

**EFC 000 G 016** Gold 24 Karat / *Gold 24 Carat*

**Maße / Dimensions:**

Ø 230 H 170

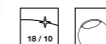

**Porzellan-Rundplatte**

*Spare China Platter*

**3PO020**



**Abdeckhaube**

*Cover Hood*

**EB 583 E** Edelstahl / *St. St.*

**EB 583 G** Gold / *Gold*





**ELEGANCE Frischeschale 'Buffet Bowl'**  
*ELEGANCE Freshness Dish 'Buffet Bowl'*

Inhalt: 1,5 Liter  
Kunststoffschale/-dekoring (PC, weiß),  
transparenter Kunststoffdeckel,  
Einsatzschüssel aus Edelstahl, Kühlakku  
Content: 1.5 liters  
High-grade plastic bowl and decoration ring  
(PC, white), transparent plastic lid,  
stainless steel insert bowl, cooling pack

**EFC 015 K**

**Maße / Dimensions:**  
Ø 228 H 158



**Nachschubbehälter**  
Einsatzschüssel aus Edelstahl  
*Spare Bowl*  
Stainless steel insert bowl  
**3BE003**

**PURE NATURE Frischeschale 'Single'**  
*PURE NATURE Freshness Dish 'Single'*

**Buche hell / Natural Beech**

**Frischeschale 'Single S'**  
Inhalt: 2 Liter  
*Freshness Dish 'Single S'*  
Content: 2 liters

**RFC 020 X**

**Maße / Dimensions:**  
H 270 H 250 L 250

**Frischeschale 'Single L'**  
Inhalt: 2 Liter  
*Freshness Dish 'Single L'*  
Content: 2 liters

**RFC 020 X 002**

**Maße / Dimensions:**  
H 300 H 250 L 250



**Porzellanbehälter (2 l)**  
*Spare china dish (2 l)*  
**3BE002**

**Deckel**  
*China lid*  
**3DE080**



**SCHÄLCHENHALTER & HYGIENESCHUTZ / BOWL HOLDER & HYGIENIC COVER**

Kleine Helfer auf dem Buffet werden immer gebraucht, um das Angebot für den Gast komplett zu machen. Damit die Nachhaltigkeit Einzug beim Gastronom hält, sorgen die Schälchenhalter mit Glasschälchen in unterschiedlichen Größen für das Einsparen von Portionspackungen. Der hygienische Aspekt darf auch nicht unterschätzt werden. Nicht immer ist ein fest installierter Hygieneschutz auf dem Buffet vorhanden. Schnelles Auf- und Abbauen zeichnet die flexiblen Aufsteller von FRILICH aus. Ab sofort gibt es noch 'einen großen Bruder', um auf maximaler Buffetfläche den hygienischen Schutz zu ermöglichen.

*Little helpers on the buffet are always needed to complete the offer for the guest. In order to ensure that sustainability is introduced to the catering, the bowl holders with glass bowls in various sizes ensure the saving of portion packaging. The hygienic aspect should not be underestimated either. Not always is a permanently installed hygiene protection on the buffet available. Fast assembly and disassembly characterizes the flexible stands of FRILICH. From now on there is still 'a big brother' to allow maximum buffet area the hygienic protection.*





**ELEGANCE Schälchenhalter 'Mini'**  
ELEGANCE Bowl Holder 'Mini'

inkl. 30 Glasschälchen (Ø 60 mm)  
incl. 30 glass bowls (Ø 60 mm)

 **Glasschälchen (Ø 60 mm)**  
Glass Bowl (Ø 60 mm)  
3GL003

**EB 616 E** Edelstahl / Stainless Steel

**EB 616 G 003** Gold 24 Karat / Gold 24 Carat

**Maße / Dimensions:**  
Ø 160 H 210



**ELEGANCE Schälchenhalter 'Maxi'**  
ELEGANCE Bowl Holder 'Maxi'

inkl. 60 Glasschälchen (Ø 70 mm)  
incl. 60 glass bowls (Ø 70 mm)

 **Glasschälchen-Set (Ø 70 mm)**  
Einheit zu je 6 Glasschälchen  
Set of Glass Bowls (Ø 70 mm)  
unit of 6 glass bowls  
EB 577

**EB 616 E 003** Edelstahl / Stainless Steel

**Maße / Dimensions:**  
Ø 205 H 262



 **Schälchenhalter 'Maxi' ohne Glasschälchen**  
Bowl Holder 'Maxi' without glass bowls  
EB 629 E



Beispiel: Konfitürenstation  
Example: Jam Station



Der Hygieneschutz 'Solid' besteht aus zwei äußerst robusten Haltestangen aus Edelstahl, an denen die Plexiglashaube auf fünf verschiedenen Höhen justiert werden kann. Mit einer Fläche von 900 x 500 mm finden somit gleich ganze Buffetsektionen hygienischen Schutz. Die sehr flach konstruierten Füße (H: 4 mm) geben zudem dem Gastronom die Möglichkeit, die gesamte Buffetfläche bis zum letzten Zentimeter effektiv auszunutzen.

The Hygienic Cover 'Solid' consists of two extremely sturdy handrails made of stainless steel, on which the acrylic glass cover can be adjusted to five different heights. With an area of 900 x 500 mm, whole buffet sections are thus hygienically protected. The very flat designed feet (H: 4 mm) give the user the opportunity to use the entire buffet area to the last centimeter effectively.

**GUARD Hygieneschutz 'Solid'**  
GUARD Hygienic Cover 'Solid'

**EB 735**

**Maße / Dimensions:**  
H 615 H 995 L 560



**Ersatzhaube (Acrylglas)**  
Spare Hood (Acrylic Glass)  
EB 733

**Maße / Dimensions:**  
H 30 H 900 L 500

**GUARD Hygieneschutz 'Flex 700'**  
GUARD Hygienic Cover 'Flex 700'



**EB 710 E**  
Höhe / Height: 600  
H 745 L 420

**EB 703 E**  
Höhe / Height: 390  
H 745 L 420



Anwendungsbeispiel  
Example of use

**GUARD Hygieneschutz 'Flex GN'**  
GUARD Hygienic Cover 'Flex GN'



**EB 709 E**  
Höhe / Height: 600  
H 650 L 420

**EB 702 E**  
Höhe / Height: 390  
H 650 L 420



Anwendungsbeispiel  
Example of use

**GUARD Hygieneschutz 'Flex 400'**  
GUARD Hygienic Cover 'Flex 400'



**EB 708 E**  
Höhe / Height: 600  
H 470 L 420

**EB 701 E**  
Höhe / Height: 390  
H 470 L 420



Anwendungsbeispiel  
Example of use

**GUARD Hygieneschutz 'Flex 300'**  
GUARD Hygienic Cover 'Flex 300'



**EB 707 E**  
Höhe / Height: 600  
H 370 L 420

**EB 700 E**  
Höhe / Height: 390  
H 370 L 420



Anwendungsbeispiel  
Example of use



Neigung verstellbar  
Inclination adjustable

**GUARD Hygieneschutz 'Flex'** für Servierplatten- und Schalen bis zu einer Breite von 745 mm. Eine ideale Möglichkeit zum Abdecken von Buffetflächen. FRILICH bietet vier verschiedene Breiten in zwei unterschiedlichen Höhen. Selbstverständlich beinhaltet das Angebot auch eine Lösung für 1/1 GN Größen.

**GUARD Hygienic Cover 'Flex'** for all serving plates and dishes up to a width of 745 mm. An ideal way to cover buffet areas. FRILICH offers four different widths in two different heights. Of course, the offer also includes hood system for 1/1 GN sizes.

Das Buffet hygienisch einwandfrei und attraktiv gestalten – Frilich hat eine perfekte und zugleich variable Lösung mit vielen Vorzügen entwickelt:

- Hygieneschutz dank unauffälliger Bauteile kaum wahrnehmbar auf dem Buffet
- 4 unterschiedliche Größen in 2 verschiedenen Höhen
- Acrylglas-Hauben sind im Neigungswinkel variabel justierbar
- schnell zusammenzustecken und platzsparend zu verstauen

To present a buffet in hygienically impeccable and attractive manner – Frilich developed a perfect and flexible solution. Profit from convincing advantages:

- Hygienic cover hardly perceivable due to unremarkable modules
- available in 4 different sizes and 2 different heights
- Acrylic glass boards variable adjustable in the pitch
- fast assembly and space saving storing

**RAISER Displaysystem 'Cabo™'**  
RAISER Displaysystem 'Cabo™'

Displaysystem aus Bambus gefertigt  
Display System made of Bamboo

Set aus 2 Stück  
Set of 2

G06.002.0002

Maße / Dimensions:  
☞ 152 ☞ 304 ☞ 304



Displaysystem aus Bambus gefertigt  
Display System made of Bamboo

Set aus 3 Stück  
Set of 3

G06.002.0000

Maße / Dimensions:  
RAISER 1 ☞ 203 ☞ 610 ☞ 304  
RAISER 1 ☞ 152 ☞ 457 ☞ 304  
RAISER 1 ☞ 102 ☞ 304 ☞ 304



**RAISER Displaysystem 'Heights™'**  
RAISER Displaysystem 'Heights™'

Holzraiser mit zusammenklappbaren Metallbeinen  
Wood Raiser with foldable Metal Legs

G06.013.0000

Maße / Dimensions:  
☞ 76 ☞ 351 ☞ 191

G06.013.0001

Maße / Dimensions:  
☞ 152 ☞ 401 ☞ 211

G06.013.0002

Maße / Dimensions:  
☞ 229 ☞ 500 ☞ 249



**BROT & UTENSILIEN / BREAD & UTENSILS**

Brot auf dem Buffet stellt eine besondere Herausforderung dar, um verschiedene Sorten geschnitten oder am Stück ansprechend aber auch hygienisch zu präsentieren. FRILICH bietet daher hilfreiche Systeme und Displays, die über das Brot hinaus eine Vielzahl von nicht zu kühlenden Produkten hochwertig präsentiert, um ein Stück Erlebnis mit dem Buffet zu vermitteln.

Bread on the buffet is a special challenge in order to offer different varieties sliced or in one piece with a high standard of hygienic and demand. In doing so, FRILICH offers helpful systems and displays that, in addition to bread, presents a variety of non cooling products in a high quality way and convey a piece of experience to buffet setups.

**RAISER Brot- und Obststation**  
*RAISER Bread and Fruit Station*

**Brotstation 'Vintage White'**  
*Bread Station 'Vintage White'*

aus Fichtenholz, eingehängte Brotschütte und Teiler zum Bilden von Fächern. mit weißem Lack bearbeitet in 'used look'  
*made of spruce, hinged Bread chute with divider to create divisions, white varnish in 'used look'*

**RB 648 H 003**

**Maße / Dimensions:**  
☒ 330 ☒ 330 ☒ 740

**Obststation 'Vintage White'**  
*Fruit Station 'Vintage White'*

aus Fichtenholz, eingehängte Obststeige, mit weißem Lack bearbeitet in 'used look'  
*made of spruce, hinged fruit crate white varnish in 'used look'*

**RB 648 H 004**

**Maße / Dimensions:**  
☒ 330 ☒ 330 ☒ 750



**Brotstation 'Nature'**  
*Bread Station 'Nature'*

aus Fichtenholz, eingehängte Brotschütte und Teiler zum Bilden von Fächern  
*made of spruce, hinged bread chute with divider to create divisions*

**RB 648 H 001**

**Maße / Dimensions:**  
☒ 330 ☒ 330 ☒ 740

**Obststation 'Nature'**  
*Fruit Station 'Nature'*

aus Fichtenholz, eingehängte Obststeige.  
*made of spruce, hinged fruit crate*

**RB 648 H 002**

**Maße / Dimensions:**  
☒ 330 ☒ 330 ☒ 750



Anwendungsbeispiele  
*Examples of use*



**NEW!**



**RAISER Brot- und Obststation**  
*RAISER Bread and Fruit Station*

**Brotstation 'Oak'**  
*Bread Station 'Oak'*

aus Eichenholz, eingehängte Brotschütte und Teiler zum Bilden von Fächern  
*made of oak, hinged bread chute with divider to create divisions*

**RB 648 H 005**

**Maße / Dimensions:**  
☒ 333 ☒ 338 ☒ 756

**Obststation 'Oak'**  
*Fruit Station 'Oak'*

aus Eichenholz, eingehängte Obststeige.  
*made of oak, hinged fruit crate*

**RB 648 H 006**

**Maße / Dimensions:**  
☒ 333 ☒ 338 ☒ 764



Anwendungsbeispiele  
*Examples of use*



**NEW!**

**BOX Bread 'Largo'**



Stapelbare Brotbox aus Eichenholz, Acryl-Schubfach mit Edelstahlgriff  
Stackable bread box made of oak, acrylic drawer with stainless steel knob

**BTO 120 H**

**Maße / Dimensions:**

150 x 360 x 377

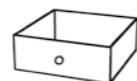

Ersatzschubfach aus Acryl mit Edelstahlgriff  
Spare drawer made of acrylic with stainless steel knob

**BB 100**



Anwendungsbeispiel / Examples of use



Ersatzschubfach aus Acryl mit Edelstahlgriff  
Spare drawer made of acrylic with stainless steel knob

**BB 101**

**BOX Bread 'Slender'**



Stapelbare Brotbox aus Eichenholz, Acryl-Schubfach mit Edelstahlgriff  
Stackable bread box made of oak, acrylic drawer with stainless steel knob

**BTO 070 H**

**Maße / Dimensions:**

180 x 180 x 377



**NEW!**

**BOX Bits and Pieces 'Largo'**



Stapelbare Box für Gastro-Utensilien aus Eichenholz, Acryl-Schubfach mit Eingriff  
Stackable Box for Gastro utensils made of oak, acrylic drawer with opening hole

**BTO 014 H**

**Maße / Dimensions:**

79 x 185 x 200



Ersatzschubfach aus Acryl mit Griffmulde  
Spare drawer made of acrylic with recessed grip

**3PL058**



Anwendungsbeispiel / Examples of use



Ersatzschubfach aus Acryl mit mit Griffmulde  
Spare drawer made of acrylic with recessed grip

**3PL057**

**BOX Bits and Pieces 'Slender'**



Stapelbare Box für Gastro-Utensilien aus Eichenholz, Acryl-Schubfach mit Eingriff  
Stackable Box for Gastro utensils made of oak, acrylic drawer with opening hole

**BTO 006 H**

**Maße / Dimensions:**

79 x 93 x 200



Ersatzschubfach aus Acryl mit mit Griffmulde  
Spare drawer made of acrylic with recessed grip



**NEW!****BOX Brain Food 'Walnut'**

Box mit Abdeckung aus Walnussholz  
inkl. 6 Melaminbehälter (je 710ml)  
und Sortenschilder (6 Stück),  
individuelle Beschriftung bei Bestellung  
*Box and cover made of walnut wood with 6 con-  
tainer made of melamine (each 710 ml),  
individual inscription labels when ordering*

**LTO 043 H**

**Maße / Dimensions:**  
120 565 250



Melaminbehälter, creme  
(je 710ml)  
*Melamin Container, Creme  
(710ml)*

**G08.004.0000****BOX Brain Food 'Oak'**

Box mit Abdeckung aus Eichenholz  
inkl. 6 Melaminbehälter (je 710ml)  
und Sortenschilder (6 Stück),  
individuelle Beschriftung bei Bestellung  
*Box and cover made of oak with 6 container  
made of melamine (each 710 ml),  
individual inscription labels when ordering*

**LTO 043 H 001**

**Maße / Dimensions:**  
120 565 250



Ersatzschild, Kunststoff mit  
Individuellem Schriftzug  
*Spare Label, Plastic with  
inscription of your choice*

**55C003**

Accessoires



**Lebensmittelechte Papiereinleger**  
(zweiseitig offen) mit Zeitungsaufdruck  
(Französisch), 100 % lebensmittelechte Druckfarbe  
*Food Save Tissue Liners (double open bag) with  
newsprint (French) 100 % food-safe ink*

**G10.006.0002** (2.000 Stück/pieces)

**Maße / Dimensions:**  
139 139



**Portionsschälchen**  
Edelstahl (Inhalt 118 ml)  
*St./St. Ramekin  
(Capacity 118 ml)*

Ø 7 cm, 48 Stück/pieces

**G03.009.0002****ELEGANCE Brotstation**  
*ELEGANCE Bread Station*

Acrylbox (transparent) mit Entnahmeöffnung.  
Deckel und Standfuß aus Edelstahl  
*Box made of acrylic with drawing window,  
lid and base made of stainless steel*

**ATO 300 T**

**Maße / Dimensions:**  
402 304 405



**RAISER Buffetsystem 'Brotkorb 33 x 33' / RAISER Buffetsystem 'Bread Basket 33 x 33'**

Korb gefertigt aus Kunststoff, spülmaschinengeeignet mit Auffangschale für Brotkrümel auf Standfußrahmen aus Eichenholz  
Basket made of plastic, suitable for dishwasher use with reservoir for bread crumbs on Oak Base Frame



Maße / Dimension: 351 351

**Standfuß L**  
H: 397  
beige / beige  
F13.400.0000  
grau / grey  
F13.400.0001

**Standfuß S**  
H: 303  
beige / beige  
F13.401.0000  
grau / grey  
F13.401.0001

**RAISER Buffetsystem 'Brotkorb 23 x 23' / RAISER Buffetsystem 'Bread Basket 23 x 23'**

Korb gefertigt aus Kunststoff, spülmaschinengeeignet mit Auffangschale für Brotkrümel auf Standfußrahmen aus Eichenholz  
Basket made of plastic, suitable for dishwasher use with reservoir for bread crumbs on Oak Base Frame



Maße / Dimension: 252 252

**Standfuß L**  
H: 396  
beige / beige  
F14.400.0000  
grau / grey  
F14.400.0001

**Standfuß S**  
H: 302  
beige / beige  
F14.401.0000  
grau / grey  
F14.401.0001

Korb gefertigt aus Kunststoff, spülmaschinengeeignet mit Auffangschale für Brotkrümel auf Standfußrahmen aus Fichtenholz, natur  
Basket made of plastic, suitable for dishwasher use with reservoir for bread crumbs on Spruce Base Frame



Maße / Dimension: 327 327

**Standfuß L**  
H: 398  
beige / beige  
F13.200.0000  
grau / grey  
F13.200.0001

**Standfuß M**  
H: 333  
beige / beige  
F13.201.0000  
grau / grey  
F13.201.0001

Korb gefertigt aus Kunststoff, spülmaschinengeeignet mit Auffangschale für Brotkrümel auf Standfußrahmen aus Fichtenholz, natur  
Basket made of plastic, suitable for dishwasher use with reservoir for bread crumbs on Spruce Base Frame



Maße / Dimension: 228 228

**Standfuß L**  
H: 397  
beige / beige  
F14.200.0000  
grau / grey  
F14.200.0001

**Standfuß M**  
H: 332  
beige / beige  
F14.201.0000  
grau / grey  
F14.201.0001

Korb gefertigt aus Kunststoff, spülmaschinengeeignet mit Auffangschale für Brotkrümel auf Standfußrahmen aus Fichtenholz, weiß lackiert in 'used look'  
Basket made of plastic, suitable for dishwasher use with reservoir for bread crumbs on Spruce Base Frame, white varnish in 'used look'



Maße / Dimension: 327 327

**Standfuß L**  
H: 398  
beige / beige  
F13.300.0000  
grau / grey  
F13.300.0001

**Standfuß M**  
H: 333  
beige / beige  
F13.301.0000  
grau / grey  
F13.301.0001

Korb gefertigt aus Kunststoff, spülmaschinengeeignet mit Auffangschale für Brotkrümel auf Standfußrahmen aus Fichtenholz, weiß lackiert in 'used look'  
Basket made of plastic, suitable for dishwasher use with reservoir for bread crumbs on spruce base frame, white varnish in 'used look'



Maße / Dimension: 228 228

**Standfuß L**  
H: 397  
beige / beige  
F14.300.0000  
grau / grey  
F14.300.0001

**Standfuß M**  
H: 332  
beige / beige  
F14.301.0000  
grau / grey  
F14.301.0001

Korb gefertigt aus Kunststoff, spülmaschinengeeignet mit Auffangschale für Brotkrümel auf Edelstahlstandfuß-Rahmen  
Basket made of plastic, suitable for dishwasher use with reservoir for bread crumbs on Stainless Steel Base Frame



Maße / Dimension: 311 311

**Standfuß L**  
H: 387  
beige / beige  
F13.000.0000  
grau / grey  
F13.000.0001

**Standfuß M**  
H: 337  
beige / beige  
F13.001.0000  
grau / grey  
F13.001.0001

**Standfuß S**  
H: 287  
beige / beige  
F13.002.0000  
grau / grey  
F13.002.0001

Korb gefertigt aus Kunststoff, spülmaschinengeeignet mit Auffangschale für Brotkrümel auf Edelstahlstandfuß-Rahmen  
Basket made of plastic, suitable for dishwasher use with reservoir for bread crumbs on Stainless Steel Base Frame



Maße / Dimension: 211 211

**Standfuß L**  
H: 362  
beige / beige  
F14.000.0000  
grau / grey  
F14.000.0001

**Standfuß M**  
H: 312  
beige / beige  
F14.001.0000  
grau / grey  
F14.001.0001

**Standfuß S**  
H: 262  
beige / beige  
F14.002.0000  
grau / grey  
F14.002.0001

Korb gefertigt aus Kunststoff, spülmaschinengeeignet mit Auffangschale für Brotkrümel auf schwarzem Metallstandfuß-Rahmen  
Basket made of plastic, suitable for dishwasher use with reservoir for bread crumbs on Black Steel Base Frame



Maße / Dimension: 336 336

**Standfuß L**  
H: 389  
beige / beige  
F13.100.0000  
grau / grey  
F13.100.0001

**Standfuß M**  
H: 339  
beige / beige  
F13.101.0000  
grau / grey  
F13.101.0001

**Standfuß S**  
H: 289  
beige / beige  
F13.102.0000  
grau / grey  
F13.102.0001

Korb gefertigt aus Kunststoff, spülmaschinengeeignet mit Auffangschale für Brotkrümel auf schwarzem Metallstandfuß-Rahmen  
Basket made of plastic, suitable for dishwasher use with reservoir for bread crumbs on Black Steel Base Frame



Maße / Dimension: 236 236

**Standfuß L**  
H: 364  
beige / beige  
F14.100.0000  
grau / grey  
F14.100.0001

**Standfuß M**  
H: 314  
beige / beige  
F14.101.0000  
grau / grey  
F14.101.0001

**Standfuß S**  
H: 264  
beige / beige  
F14.102.0000  
grau / grey  
F14.102.0001

**RAISER Buffetsystem 'Obstkorb 33 x 33' / RAISER Buffetsystem 'Fruit Basket 33 x 33'**

Metallkorb verchromt auf Standfuß-Rahmen aus Eichenholz  
 Metal Basket chromium plated on Oak Base Frame

Maße / Dimension: 351 x 351



**Standfuß L**  
 H: 307  
 F11.400.0000



**Standfuß S**  
 H: 213  
 F11.401.0000



**RAISER Buffetsystem 'Zutaten-Display 33 x 33' / RAISER Buffetsystem 'Condiment Basket 33 x 33'**

Metallkorb verchromt, Standfuß-Rahmen aus Eichenholz  
 Metal Basket chromium plated on Oak Base Frame

Maße / Dimension: 351 x 351



**Standfuß L**  
 H: 307  
 F12.400.0000

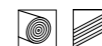

Metallkorb verchromt, Standfuß-Rahmen aus Fichtenholz, natur  
 Metal Basket chromium plated on Spruce Base Frame

Maße / Dimension: 348 x 348



**Standfuß L**  
 H: 308  
 F11.200.0000



**Standfuß M**  
 H: 243  
 F11.201.0000



Metallkorb verchromt, Standfuß-Rahmen aus Fichtenholz, natur  
 Metal Basket chromium plated on Spruce Base Frame

Maße / Dimension: 327 x 327



**Standfuß L**  
 H: 175  
 F12.200.0000



**Standfuß M**  
 H: 110  
 F12.201.0000



Metallkorb verchromt, Standfuß-Rahmen aus Fichtenholz, weiß lackiert in 'used look'  
 Metal Basket chromium plated on Spruce Base Frame, white varnish in 'used look'

Maße / Dimension: 348 x 348



**Standfuß L**  
 H: 308  
 F11.300.0000



**Standfuß M**  
 H: 243  
 F11.301.0000



Metallkorb verchromt, Standfuß-Rahmen aus Fichtenholz, weiß lackiert in 'used look'  
 Metal Basket chromium plated on Spruce Base Frame, white varnish in 'used look'

Maße / Dimension: 327 x 327



**Standfuß L**  
 H: 175  
 F12.300.0000



**Standfuß M**  
 H: 110  
 F12.301.0000



Metallkorb verchromt auf schwarzem Metallstandfuß-Rahmen  
 Metal Basket chromium plated on Black Steel Base Frame

Maße / Dimension: 348 x 348



**Standfuß L** · H: 300  
 F11.100.0000



**Standfuß M** · H: 250  
 F11.101.0000



**Standfuß S** · H: 200  
 F11.102.0000



Metallkorb verchromt auf schwarzem Metallstandfuß-Rahmen  
 Metal Basket chromium plated on Black Steel Base Frame

Maße / Dimension: 336 x 336



**Standfuß L** · H: 167  
 F12.100.0000



**Standfuß M** · H: 117  
 F12.101.0000



Metallkorb verchromt auf Edelstahlstandfuß-Rahmen  
 Metal Basket chromium plated on Stainless Steel Base Frame

Maße / Dimension: 348 x 348



**Standfuß L** · H: 300  
 F11.000.0000



**Standfuß M** · H: 250  
 F11.001.0000



**Standfuß S** · H: 200  
 F11.002.0000



Anwendungsbeispiele  
 Examples of use





**PURE NATURE Butcher Block, 'S-Cube'**  
**PURE NATURE Cheese Stand, 'S-Cube'**



**Buche hell**  
*Natural Beech*

Höhe: 120  
*Height: 120*

**3ST084**

Höhe: 165  
*Height: 165*

**3ST083**

Höhe: 210  
*Height: 210*

**3ST082**

**Maße / Dimensions:**

■ 220 ■ 220



**PURE NATURE Butcher Block, 'Oblong'**  
**PURE NATURE Cheese Stand, 'Oblong'**



**Buche hell**  
*Natural Beech*

Höhe: 120  
*Height: 120*

**3ST125**

Höhe: 165  
*Height: 165*

**3ST126**

Höhe: 210  
*Height: 210*

**3ST127**

**Maße / Dimensions:**

■ 325 ■ 220



**PURE NATURE Butcher Block, 'L-Cube'**  
**PURE NATURE Cheese Stand, 'L-Cube'**



**Buche hell**  
*Natural Beech*

Höhe: 120  
*Height: 120*

**3ST162**

Höhe: 165  
*Height: 165*

**3ST161**

Höhe: 210  
*Height: 210*

**3ST160**

**Maße / Dimensions:**

■ 325 ■ 325



Beispiel: Brotstation  
*Example: Bread Station*



**ELEGANCE Brotplatte**  
**ELEGANCE Bread Tray**

Holzblech mit Auffangbehälter  
 für Brotkrümel aus Edelstahl  
*Bread board (wood) with  
 stainless steel reservoir for bread crumbs*

**Maße / Dimensions:**

■ 35 ■ 580 ■ 375



Optional/optional:  
**Rolltop-Haube eckig (1/1 GN)**  
*Rolltop Hood rectangular (1/1 GN)*  
**10078**



**Hygieneschutz für Brotplatte**  
*Hygienic Cover for  
 bread cutting board*  
**EB 702 E**

Bei Bedarf Rolltop-Haube oder Hygieneschutz  
 extra bestellen!  
*Rolltop Hood or Hygienic Cover must be  
 ordered separately!*



Anwendungsbeispiele  
*Examples of use*

**STRUCTURE Etagere 'Maxi'**  
**STRUCTURE Display Stand 'Maxi'****Buffetpräsentation**  
*Buffet Presentation*

Dreistufige Etagere, verchromt für Porzellanplatten '33 x 33' ( Artikel: 3PO027)  
*Display Stand on three tiers, chromium plated, for China Plates '33 x 33' ( Article: 3PO027)*

**3ST080**

**Maße / Dimensions:**  
 ☰ 760 ☱ 520 ☲ 360

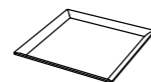

**Porzellanplatte, weiß**  
*China Plate, white*  
**3PO027**

! Porzellanplatten extra bestellen  
*China Plates must be ordered separately*

! Passend auch für Porzellanplatten '33 x 33' (Seite 106)  
*Also with China Plates '33 x 33' (see page 106)*

**STRUCTURE Etagere 'Mini'**  
**STRUCTURE Display Stand 'Mini'****Buffet- und Tischpräsentation**  
*Buffet and Table Presentation*

Zweistufige Etagere, verchromt für Porzellanplatten, Teilplatte klein ( Artikel: 3PO029)  
*Display Stand on two tiers, chromium plated, for China Plates, Partial Plate, small ( Article: 3PO029)*

**3ST109**

**Maße / Dimensions:**  
 ☰ 305 ☱ 190 ☲ 325

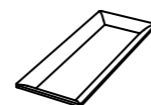

**Porzellanplatte, weiß**  
*China Plate, white*  
**3PO029**

Dreistufige Etagere, verchromt für Porzellanplatten, Teilplatte klein ( Artikel: 3PO029)  
*Display Stand on three tiers, chromium plated, for China Plates, Partial Plate, small ( Article: 3PO029)*

**3ST110**

**Maße / Dimensions:**  
 ☰ 455 ☱ 190 ☲ 325

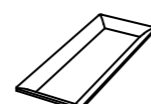

**Porzellanplatte, weiß**  
*China Plate, white*  
**3PO029**

! Porzellanplatten extra bestellen  
*China Plates must be ordered separately*

**GASTRO**

Auch in der Systemverpflegung besteht Anspruch auf funktionelle Helfer, die einerseits den Service bei der Präsentation verschiedener Gastronomieartikel unterstützen, andererseits aber auch robust im Umgang und formschön im Design sein sollen. Auf den nächsten Seiten bietet FRILICH einige Lösungen, die nicht nur bei der Kaffeeausgabe, sondern auch bei vielen Anforderungen den Gastronom in seinem Arbeitsumfeld entlasten.

*Also in the system catering, there is a demand for functional helpers, who on the one hand supports the service in the presentation of various gastronomic articles, but on the other hand, should also be robust in their handling shapely in design. On the following pages, FRILICH offers a number of solutions that relieve the caterer of his working environment, not just when it comes to dispensing coffee, but also for many other requirements.*

Anwendungsbeispiele  
Examples of use



inkl. Wandmontage  
incl. wall fastening

## Vario Rack 'Metropol'

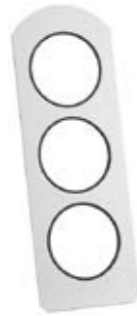

**Aluminium-Trägerplatte  
mit 3 Aufnahmelöchern**  
Aluminium Mounting Plate  
with 3 location holes  
DB 053

**Maße**  
(Standfuß mit Trägerplatte)  
Dimensions  
(Base with Mounting Plate)  
☞ 427 ☞ 150 ☞ 210

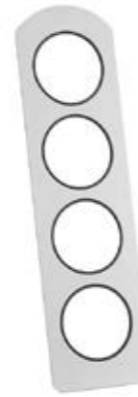

**Aluminium-Trägerplatte  
mit 4 Aufnahmelöchern**  
Aluminium Mounting Plate  
with 4 location holes  
DB 054

**Maße**  
(Standfuß mit Trägerplatte)  
Dimensions  
(Base with Mounting Plate)  
☞ 549 ☞ 150 ☞ 210

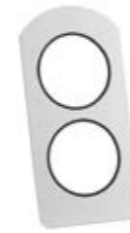

**Aluminium-Trägerplatte  
mit 2 Aufnahmelöchern**  
Aluminium Mounting Plate  
with 2 location holes  
DB 052

**Maße**  
(Standfuß mit Trägerplatte)  
Dimensions  
(Base with Mounting Plate)  
☞ 294 ☞ 160 ☞ 210



**Wandmontage inkl. Schraubensatz  
(Metall, pulverbeschichtet)**  
schwarz, zum Befestigen der Trägerplatten  
Wall fastening incl. screw set  
(metal, powder coated)  
black, for fastening of mounting plates  
DB 055

**Maße / Dimensions:** ☞ 80 ☞ 145 ☞ 200



**Kunststoff-Standfuß**  
schwarz, zum Einsetzen der Trägerplatten  
Plastic Base  
black, for insertion of mounting plates  
DB 051



**1 Becher 0,6 Liter, opal**  
Cup 0.6 liters, opal  
3SA053



**2 Becherteiler  
(für kleine Sachets), opal**  
Cup Divider, opal  
(for smallest sachets)  
1ME016



**3 Becherverlängerung  
(für Besteckpräsentation), opal**  
Cup Extension, opal  
(for presentation of cutlery)  
1ME018



**4 Schütte 0,6 Liter, opal**  
Product Dish 0.6 liters, opal  
1ME015



**5 Schütte 1 Liter, opal**  
Product Dish 1 liter, opal  
1ME022



**6 Schütte 2 Liter, opal**  
Product Dish 2 liter, opal  
1ME023



**Frischeschälchen (Edelstahl)**  
Inkl. Kühlakku  
Small Cooling Dish  
(Stainless Steel)  
incl. Cooling Pack  
DB 045

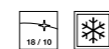

Anwendungsbeispiele  
Examples of use





### Streuozucker-Spender 'Trio' Granulated Sugar Dispenser 'Trio'

Inhalt: 2 Liter Kaffeesahne  
1 kg Streuzucker  
Content: 2 liters coffee cream  
1 kg granulated sugar

DFO 002 A 017

Maße / Dimensions:  
E 445 H 335 L 340



- siehe Streuzucker- und Kaffeesahnespender 'Uno'
- inkl. Beschriftung 'Zucker' / 'Milch'
  - mit praktischem Schälchen für Süßstoffspender
  - einfache Bedienung und Reinigung
  - Dosierventil stets trocken reinigen
- see Granulated Sugar Dispenser and Coffee Cream Dispenser 'Uno'
- comes with product lettering 'Zucker' / 'Milch' or with stickers 'Sugar' / 'Milk' in languages on request
  - with handy holder for sweetener
  - simple operation and cleaning
  - always keep dispenser valve dry

 Nachschubbehälter für 2 Liter Kaffeesahne  
Spare Container for coffee cream 2 liters  
DB 025



### Streuozucker-Spender 'Uno' Granulated Sugar Dispenser 'Uno'

Inhalt: 1 kg  
Content: 1 kg

DTO 002 N 003

Maße / Dimensions:  
E 445 H 208 L 340



- inkl. Beschriftung 'Zucker'
- einmal Dosieren entspricht einem Teelöffel
- einfache Bedienung und Reinigung
- Dosierventil stets trocken reinigen
- press once to get one teaspoon of sugar
- simple operating and cleaning
- comes with product lettering 'Zucker' or with sticker 'Sugar' in languages on request
- always keep dispenser valve dry



### Kaffeesahne-Spender 'Uno' Coffee Cream Dispenser 'Uno'

Inhalt: 2 Liter  
Content: 2 liters

DFO 002 A 016

Maße / Dimensions:  
E 360 H 208 L 340



- inkl. Beschriftung 'Milch', Kühlakku im Standfuß sowie Austausch-Akku
- hygienisch dosiert mit Edelstahlhahn
- Innenbehälter für Kaffeesahne aus Edelstahl
- comes with product lettering 'Milch' or with sticker 'Milk' in languages on request
- cooling pack in base as well as replacement pack
- hygienic dispensing with the Frilich high-grade stainless steel faucet
- inner cream container in high-grade stainless steel

 Nachschubbehälter für 2 Liter Kaffeesahne  
Spare Container for coffee cream 2 liters  
DB 025



### Vario Rack 'Farm'

mit drei schmalen Körben  
with three slim baskets

Displaykörbe (à 0,7 Liter) aus Kunststoff gefertigt, beige, spülmaschinengeeignet, Edelstahlrahmen mit Standfüßeinlage aus Holz  
Display Baskets (à 0,7 Liter) made of Plastic, beige. Suitable for dishwasher use, Stainless Steel Frame with Wooden Base Insert

DVO 020 H

Maße / Dimensions:  
E 370 H 180 L 310



Displaykorb aus Kunststoff gefertigt, beige  
Display Basket made of Plastic, beige

schmal / slim  
3K0023  
E 50 H 145 L 210



Standfüßeinlage aus Holz  
Wooden Base Insert

für Vario Rack 'Farm' mit schmalen Körben  
for Vario Rack 'Farm' with slim baskets

DB 056



mit drei breiten Körben  
with three wide baskets

Displaykörbe (à 1,7 Liter) aus Kunststoff gefertigt, spülmaschinengeeignet, Edelstahlrahmen mit Standfüßeinlage aus Holz  
Display Baskets (à 1,7 Liter) made of Plastic, suitable for dishwasher use, Stainless Steel Frame with Wooden Base Insert

DVO 050 H

Maße / Dimensions:  
E 370 H 335 L 310



Displaykorb aus Kunststoff gefertigt, beige  
Display Basket made of Plastic, beige

breit / wide  
3K0022  
E 50 H 320 L 210



Standfüßeinlage aus Holz  
Wooden Base Insert

für Vario Rack 'Farm' mit breiten Körben  
for Vario Rack 'Farm' with wide baskets

DB 057



**Reinigungsbürsten**  
*Cleaning Brushes*



**Reinigungsbürste für Acrylglasröhre**  
**CONNECT Juicer und CONNECT Hopper**  
*Cleaning Brush for CONNECT Juicer and CONNECT Hopper*  
**3ZU026**



**Reinigungsbürste für Karaffen, Glas bzw. Kunststoff**  
**CARAFINE und CONNECT**  
*Cleaning Brush for CARAFINE and CONNECT Carafes (Glass and Plastic)*  
**3ZU063**

**Schilder**  
*Label*



**Tafelschild selbstklebend**  
25 Stück inkl. Kreide-Schreibset, weiß (6 Stück)  
*Blackboard Sticker, stick-on*  
*25 pcs. incl. crayon set (6 pcs.)*  
**EB 714 K**



**Kettenschild aus Holz**  
mit individueller Beschriftung  
*Label Chain (wood)*  
*individual inscription*  
**5SC001**



**Steckschild aus Holz**  
mit individueller Beschriftung  
*Insert Label (wood)*  
*Inscription of choice*  
**5SC002**



Anwendungsbeispiele  
*Examples of use*

**Schilderhalter**  
*Label Holders*



**Halter, Naturstein**  
zum Einstellen von Tischkarten und Platzkarten  
*Holder, Natural Stone*  
*to clip name or place cards*

Carrara / Carrara  
**3SH010**

Granit / Granite  
**3SH011**

Basalt / Basalt  
**3SH012**



**Halter**  
zum Einstellen von Tischkarten und Platzkarten  
*Holder*  
*to clip name or place cards*

Holz, Dekor Kirsche / Wood, Décor cherry  
**3SH013**



**Schilderfeder Edelstahl**  
zum Einklemmen von Tischkarten und Platzkarten  
*Label Clip Stainless Steel*  
*to clip name or place cards*  
**8SH001**

**Aufstellschilder**  
*Free-Standing Labels*



**Modell Edelstahl**  
mit individueller Beschriftung (gelasert), bis zu drei verschiedene Sprachen auf einem Schild möglich  
*Model Stainless Steel*  
*laser-engraved, inscription of choice, up to three languages per label possible*

**3SC330E** Edelstahl / Stainless Steel  
**3SC330G** Gold / Gold

**Lackstift**  
*Lacquer Pen*



**Lackstift**  
zur Ausbesserung von Lackschäden der RAISER ('Black Steel')  
*Lacquer Pen*  
*for repair of lacquer on damaged black iron base RAISER (Black Steel)*  
**3ZU024**

**Laserbeschriftung**  
Laser Marking



Laserservice für alle FRILICH Edelstahl-Deckel (individuelle Beschriftung, bis zu drei verschiedene Sprachen auf einem Edelstahl-Deckel möglich)  
Laser-engraving for all FRILICH st. st. lids (inscription of choice, up to three languages per lid possible)

9DE001



Laserservice für alle FRILICH Edelstahl-Deckel (Motive in verschiedenen Fruchtarten)  
Laser-engraving for all FRILICH st. st. lids (Motifs in different sorts of fruits)



Motiv 'Orange'  
Motif 'Orange'  
9DE002



Motiv 'Erdbeere'  
Motif 'Strawberry'  
9DE005



Motiv 'Pfirsich'  
Motif 'Peach'  
9DE004



Motiv 'Grapefruit'  
Motif 'Grapefruit'  
9DE014



Motiv 'Wasser'  
Motif 'Water'  
9DE016



Motiv 'Kiwi'  
Motif 'Kiwi'  
9DE006



Motiv 'Wassermelone'  
Motif 'Water Melon'  
9DE007



Motiv 'Birne'  
Motif 'Pear'  
9DE008



Motiv 'Kirsche'  
Motif 'Cherry'  
9DE010



Motiv 'Apfel'  
Motif 'Apple'  
9DE003



Motiv 'Traube'  
Motif 'Grape'  
9DE011



Motiv 'Multivitamin'  
Motif 'Fruits'  
9DE017



Motiv 'Pflaume'  
Motif 'Plum'  
9DE013



Motiv 'Milch'  
Motif 'Milk'  
9DE015



Motiv 'Banane'  
Motif 'Banana'  
9DE018

! Weitere Laserbeschriftungen auf Anfrage erhältlich  
Ask for more variations of laser markings

**Laserservice**  
Laser-Engraving



Anwendungsbeispiel  
Example of use

Für FRILICH Produkte aus Edelstahl oder Holz sind individuell gelaserte Beschriftungen möglich. Saftkannen, Müsliflöten und vieles mehr erhalten so ihre persönliche gelaserte oder bedruckte Kennzeichnung. Wenden Sie sich an Ihren FRILICH Ansprechpartner. FRILICH products in Stainless Steel or Wood can be individually scripted. This way, juice dispensers, muesli flutes and many more products obtain their personal mark (as engraving or print). Please contact FRILICH for further information.



Anwendungsbeispiele  
Examples of use

Spoon Rest



Porzellanschälchen für Vorlegebesteck  
China Bowl, small, for serving cutlery

3PO054

Maße / Dimensions:  
18 x 60 x 80



Anwendungsbeispiel  
Example of use

Löffel (Kunststoff)  
Spoons (Plastic)



Löffel für Konfitürenbar  
Spoon for Jam Bar  
3ZU001



Löffel für Frischeschale  
Spoon for Freshness Dish  
3ZU007

Besteck (Edelstahl)  
Cutlery (Stainless Steel)



Vorlegegabel (29 cm)  
für FRILICH Schalen  
Serving Fork  
for FRILICH Dish/Bowl  
3ZU037



Vorlegelöffel (29 cm)  
für FRILICH Schalen  
Serving Spoon  
for FRILICH Dish/Bowl  
3ZU038



Schöpfkelle für  
FRILICH Bowl Bar S  
Ladle for FRILICH Bowl S  
3ZU039



Schöpfkelle für  
FRILICH Bowl Bar M  
Ladle for FRILICH Bowl M  
3ZU040



Schöpfkelle (26 cm)  
für FRILICH Bowl Bar L  
Ladle for FRILICH Bowl L  
3ZU041



Aufschnittgabel (18 cm)  
für FRILICH Plattensysteme  
Fork for cold cuts  
for FRILICH platter systems  
3ZU042





































































Servierzange, klein  
für FRILICH Plattensysteme  
Serving Gripper, small  
for FRILICH platter systems  
3ZU043



Konfitürenlöffel, lang  
Long necked Spoon for Jam  
3ZU044

RAISER

|  |  |   |   |  |
|--|--|---|---|--|
| <br><b>Standfußrahmen 'Oak'</b><br>Base Frame 'Oak'<br>33x33<br>Höhe/Height: L<br><b>5ST084</b>  | <br><b>Standfußrahmen 'Spruce'</b><br>Base Frame 'Spruce'<br>33x33<br>Höhe/Height: L<br><b>5ST050</b>   | <br><b>Standfußrahmen 'Vintage White'</b><br>Base Frame 'Vintage White'<br>33x33<br>Höhe/Height: L<br><b>5ST049</b>  | <br><b>Standfußrahmen 'Edelstahl'</b><br>Base Frame 'Stainless Steel'<br>33x33<br>Höhe/Height: L<br><b>3ST100</b>  | <br><b>Standfußrahmen 'Black Steel'</b><br>Base Frame 'Black Steel'<br>33x33<br>Höhe/Height: L<br><b>3ST085</b>                                   |
| <br><b>Standfußrahmen 'Oak'</b><br>Base Frame 'Oak'<br>33x33<br>Höhe/Height: S<br><b>5ST085</b>  | <br><b>Standfußrahmen 'Spruce'</b><br>Base Frame 'Spruce'<br>33x33<br>Höhe/Height: M<br><b>5ST052</b>   | <br><b>Standfußrahmen 'Vintage White'</b><br>Base Frame 'Vintage White'<br>33x33<br>Höhe/Height: M<br><b>5ST051</b>  | <br><b>Standfußrahmen 'Edelstahl'</b><br>Base Frame 'Stainless Steel'<br>33x33<br>Höhe/Height: M<br><b>3ST101</b>  | <br><b>Standfußrahmen 'Black Steel'</b><br>Base Frame 'Black Steel'<br>33x33<br>Höhe/Height: M<br><b>3ST086</b>                                   |
| <br><b>Standfußrahmen 'Oak'</b><br>Base Frame 'Oak'<br>23x23<br>Höhe/Height: L<br><b>5ST086</b>  | <br><b>Standfußrahmen 'Spruce'</b><br>Base Frame 'Spruce'<br>23x23<br>Höhe/Height: L<br><b>5ST054</b>   | <br><b>Standfußrahmen 'Vintage White'</b><br>Base Frame 'Vintage White'<br>23x23<br>Höhe/Height: L<br><b>5ST053</b>  | <br><b>Standfußrahmen 'Edelstahl'</b><br>Base Frame 'Stainless Steel'<br>23x23<br>Höhe/Height: S<br><b>3ST102</b>  | <br><b>Standfußrahmen 'Black Steel'</b><br>Base Frame 'Black Steel'<br>23x23<br>Höhe/Height: S<br><b>3ST087</b>                                   |
| <br><b>Standfußrahmen 'Oak'</b><br>Base Frame 'Oak'<br>23x23<br>Höhe/Height: S<br><b>5ST087</b>  | <br><b>Standfußrahmen 'Spruce'</b><br>Base Frame 'Spruce'<br>23x23<br>Höhe/Height: M<br><b>5ST056</b>   | <br><b>Standfußrahmen 'Vintage White'</b><br>Base Frame 'Vintage White'<br>23x23<br>Höhe/Height: M<br><b>5ST055</b>  | <br><b>Standfußrahmen 'Edelstahl'</b><br>Base Frame 'Stainless Steel'<br>23x23<br>Höhe/Height: L<br><b>3ST103</b>  | <br><b>Standfußrahmen 'Black Steel'</b><br>Base Frame 'Black Steel'<br>23x23<br>Höhe/Height: L<br><b>3ST072</b>                                   |
| <br><b>Kunststoffeinsatz</b><br>Plastic Insert<br>33x33<br><b>3EI057</b><br>23x23<br><b>3EI055</b>   | <br><b>Dekor-Metallplatte für Buffet Bowl 23x23</b><br>Decoration Steel Frame for Buffet Bowl 23x23<br><b>Maxi</b><br>Anthrazit<br><b>3EI081</b><br>Stainless Steel<br><b>3EI112</b><br><b>Medium</b><br>Anthrazit<br><b>3EI080</b><br>Stainless Steel<br><b>3EI111</b> | <br><b>Dekor-Metallplatte mit Kunststoffeinsatz für Buffetschale 23x23 und Rundplatte 23x23</b><br>Decoration Steel Frame with Plastic Insert for Buffet Bowl 23x23 and Round Plate 23x23<br><b>Anthrazit</b><br><b>RB 591</b><br>Stainless Steel<br><b>RB 592</b> | <br><b>Standfußrahmen 'Edelstahl'</b><br>Base Frame 'Stainless Steel'<br>23x23<br>Höhe/Height: M<br><b>3ST104</b>  | <br><b>Standfußrahmen 'Black Steel'</b><br>Base Frame 'Black Steel'<br>23x23<br>Höhe/Height: M<br><b>3ST073</b>                                   |
| <br><b>Kühlkissen</b><br>Cooling Cushion<br>33x33 / GN<br><b>3KU010</b><br>23x23<br><b>3KU014</b>   |  |   | <br><b>Standfußrahmen 'Edelstahl'</b><br>Base Frame 'Stainless Steel'<br>23x23<br>Höhe/Height: S<br><b>3ST144</b>   | <br><b>Standfußrahmen 'Black Steel'</b><br>Base Frame 'Black Steel'<br>23x23<br>Höhe/Height: S<br><b>3ST145</b>                                  |
| <br><b>Abdeckhaube für Rundplatte 23x23 inkl. Edelstahlgriff</b><br>Cover Hood for Round Plate 23x23<br>incl. St/St Knob<br><b>EB 583 E</b>  | <br><b>Metallkorb für Obstkorb 33x33</b><br>Metal Basket for Fruit Basket 33x33<br><b>3KO003</b>  | <br><b>Metallkorb für Zutatendisplay 33x33</b><br>Metal Basket for Condiment Display 33x33<br><b>3KO019</b>  | <br><b>Korb, Kunststoff für Brotkorb 33x33</b><br>Plastic Basket for Bread Basket 33x33<br>grau/grey<br><b>3KO021</b><br>beige<br><b>3KO020</b>  | <br><b>Korb, Kunststoff für Brotkorb 23x23</b><br>Plastic Basket for Bread Basket 23x23<br>grau/grey<br><b>3KO008</b><br>beige<br><b>3KO007</b> |
| <br><b>Edelstahlschale für Getränke-Set 33x33</b><br>Stainless Steel Dish for Beverage Set 33x33<br><b>3EI087</b>  | <br><b>Edelstahlschale für Getränke-Set 23x23</b><br>Stainless Steel Dish for Beverage Set 23x23<br><b>3EI088</b>   | <br><b>Kühlrippe für Getränke-Set 33x33</b><br>Cooling Fin for Beverage Set 33x33<br><b>3KU012</b>   | <br><b>Kühlrippe für Getränke-Set 23x23</b><br>Cooling Fin for Beverage Set 23x23<br><b>3KU013</b>   | <br><b>Bügelflasche für Getränke-Set</b><br>Flip-Top Bottle for Beverage Set<br><b>3GL020</b>   |
| <br><b>Porzellanplatte für Frischeplatte 33x33</b><br>China Plate for Freshness Plate 33x33<br>weiß/white<br><b>3PO027</b><br>blau/blue<br><b>3PO055</b><br>rot/red<br><b>3PO122</b><br>grau/grey<br><b>3PO057</b><br>caramel/caramel<br><b>3PO058</b> | <br><b>Porzellanplatte für Frischeplatte 23x23</b><br>China Plate for Freshness Plate 23x23<br>weiß/white<br><b>3PO030</b><br>blau/blue<br><b>3PO059</b><br>rot/red<br><b>3PO123</b><br>grau/grey<br><b>3PO061</b><br>caramel/caramel<br><b>3PO062</b>                | <br><b>Porzellanschale für Frischeschale 33x33</b><br>China Dish for Freshness Dish 33x33<br>weiß/white<br><b>8PO005</b><br>blau/blue<br><b>3PO131</b><br>rot/red<br><b>3PO132</b><br>grau/grey<br><b>3PO133</b><br>caramel/caramel<br><b>3PO134</b>             | <br><b>Porzellanschale für Frischeschale 23x23</b><br>China Dish for Freshness Dish 23x23<br>weiß/white<br><b>3PO135</b><br>blau/blue<br><b>3PO136</b><br>rot/red<br><b>3PO137</b><br>grau/grey<br><b>3PO138</b><br>caramel/caramel<br><b>3PO139</b> |  |

|   |   |   |  |
|---|---|---|--|
| <br><b>Porzellankugel 3,5 Liter inkl. Deckel für Buffet Bowl Maxi 23x23</b><br>China Bowl incl. Lid for Buffet Bowl Maxi 23x23<br>weiß/white<br><b>RB 569</b><br>blau/blue<br><b>RB 586</b><br>rot/red<br><b>RB651</b><br>grau/grey<br><b>RB 588</b><br>caramel/caramel<br><b>RB 589</b> | <br><b>Porzellankugel 1,5 Liter inkl. Deckel für Buffet Bowl Medium 23x23</b><br>China Bowl incl. Lid for Buffet Bowl Medium 23x23<br>weiß/white<br><b>RB 568</b><br>blau/blue<br><b>RB 582</b><br>rot/red<br><b>RB652</b><br>grau/grey<br><b>RB 584</b><br>caramel/caramel<br><b>RB 585</b> | <br><b>Porzellanschale für Buffetschale 23x23</b><br>China Bowl for Buffet Bowl 23x23<br>weiß/white<br><b>3PO008</b><br>blau/blue<br><b>3PO079</b><br>rot/red<br><b>3PO128</b><br>grau/grey<br><b>3PO081</b><br>caramel/caramel<br><b>3PO082</b> | <br><b>Porzellanplatte für Rundplatte 23x23</b><br>China Plate for Round Plate 23x23<br>weiß/white<br><b>3PO020</b><br>blau/blue<br><b>3PO083</b><br>rot/red<br><b>3PO129</b><br>grau/grey<br><b>3PO085</b><br>caramel/caramel<br><b>3PO086</b> |
| <br><b>Glascontainer mit Bügelverschluss</b><br>Glass Container with Flip-Top Lid<br>Barrel 'Classic', 5 Liter<br><b>3GL023</b><br>Barrel 'Classic', 8 Liter<br><b>3GL024</b>  | <br><b>Universaladapter für Montage des FRILICH Zapfhahnes</b><br>Universal Adapter for FRILICH Faucet assembling<br><b>RB 708</b>   | <br><b>Dekorplatte für Glascontainer</b><br>Decor Frame for Glass Container<br>Stainless Steel<br><b>RB 714</b>  | <br><b>Eisschale für Glascontainer</b><br>Ice Insert for Glass Container<br><b>3EI105</b>   |
| <br><b>Edelstahlhahn, komplett</b><br>Stainless Steel Faucet, complete<br><b>BB 803 E</b>  | <br><b>Hahnkörper (Edelstahlhahn)</b><br>Faucet Body (Stainless Steel Faucet)<br><b>3HA020</b>   | <br><b>Haube, Griff (Edelstahlhahn)</b><br>Cap, Handle (Stainless Steel Faucet)<br><b>3HA019</b>   | <br><b>Kühlakku</b><br>Cooling Pack<br><b>3KU007</b>  |
| <br><b>Scheibendichtung für Zapfhähne</b><br>Disc Shaped Washer for Faucets<br><b>3DI002</b>   | <br><b>Eisschale für Frischeplatte GN</b><br>Ice Insert for Freshness Plate GN<br><b>3EI117</b>  |   |  |
| <b>ACE OF VASE</b>  |   |   |  |
| <br><b>Saftzylinderröhre</b><br>Juice Cylinder Tube<br><b>3BE022</b>   | <br><b>Edelstahlhahn, komplett</b><br>Stainless Steel Faucet, complete<br><b>BB 803 E</b>  | <br><b>Hahnkörper (Edelstahlhahn)</b><br>Faucet Body (Stainless Steel Faucet)<br><b>3HA020</b>   | <br><b>Haube, Griff (Edelstahlhahn)</b><br>Cap, Handle (Stainless Steel Faucet)<br><b>3HA019</b>  |
| <br><b>Eisschale für Saftzylinderröhre</b><br>Ice Insert for Juice Cylinder Tube<br><b>3EI120</b>  | <br><b>Scheibendichtung für Zapfhähne</b><br>Disc Shaped Washer for Faucets<br><b>3DI002</b>   | <br><b>Kühlakku</b><br>Cooling Pack<br><b>3KU007</b>   | <br><b>Standfuß 'Uno'</b><br>Stand 'Uno'<br><b>5ST082</b>   |
| <br><b>Universaladapter für Montage des FRILICH Zapfhahnes</b><br>Universal Adapter for FRILICH Faucet assembling<br><b>RB 708</b>   | <br><b>Tropfschale und Tropfgitter</b><br>Drip Tray and Drip Dish<br><b>RB 907 E</b>   | <br><b>Standfuß 'Duo'</b><br>Stand 'Duo'<br><b>5ST083</b>  |  |

CARAFINE

- Crasheisröhre für Triplett und Quintet**  
Edelstahl  
Crushed Ice Tube for Triplett and Quintet  
Stainless Steel  
**3CR011**
- Kühlakku (einzeln)**  
Cooling Pack for Solo (single)  
**3KU011**
- Kratzschutz, Kunststoff (schwarz) für Solo**  
Scratch Guard, plastic (black) for Solo  
**3ME025**
- Kunststoffeinsatz Trio**  
Plastic Inset Trio  
**5E1012**
- Rahmeneinsatz Septet**  
Support Frame Septet  
**5ME005**
- Edelstahl Tropfschale Crystal**  
Stainless Steel Drip Tray Solo Crystal  
**3TS035**
- Kunststoffeinsatz Septet**  
Plastic Inset Septet  
**5E1011**
- Kunststoffeinsatz Solo**  
Plastic Inset Solo  
**5E1013**
- Isolierter Standfuß poliert mit drei Kühlakkus im Edelmantel**  
Insulated Base including cooling packs and stainless steel shell  
Edelstahl / Stainless Steel  
**EB 632 E**  
Gold / Gold  
**EB 632 G**
- Edelstahldeckel für Karaffe 1,2 Liter**  
Stainless steel Lid for Carafe 1.2 liters  
**3ME020**
- Silikonstopfen für Milchflasche, 1,0 Liter**  
Silicone Plug for Milk-Bottle 1,0 Liters  
**3DE097**
- Kunststoffkaraffe, 1,2 Liter**  
Plastic Carafe, 1,2 Liters  
**3BE009**
- Bügelflasche, 1,0 Liter**  
Swing-Top Bottle, 1,0 Liters  
**3GL021**
- Porzellankaraffe, 1,2 Liter**  
China Carafe, 1,2 Liters  
**3PO039**
- Glaskaraffe, 1,2 Liter**  
Glass Carafe, 1,2 Liters  
**3GL007**
- Glasflasche mit Milchmotiv, 1,0 Liter**  
Glass Bottle with Milk Motif, 1,0 Liters  
**3GL022**

ELEGANCE Saft- und Milchkannen · Juice and Milk Dispenser

- Edelstahlhahn, komplett**  
Stainless Steel Faucet, complete  
**BB 803 E**
- Hahnkörper (Edelstahlhahn)**  
Faucet Body (Stainless Steel Faucet)  
**3HA020**
- Haube, Griff (Edelstahlhahn)**  
Cap, Handle (Stainless Steel Faucet)  
**3HA019**
- Non-Drip Hahn, komplett**  
Modell Edelstahl  
Non-Drip Faucet, complete  
Model Stainless Steel  
**BB 802 E**
- Scheibendichtung**  
Disk shaped washer  
**3DI002**
- Saftzylinder, Acrylglas 9 Liter**  
Juice Container, acrylic glass 9 liters  
**3PL035**
- Saftzylinder Aktiv, 5 Liter**  
spülmaschinene geeignet, mit Aluboden  
Juice Container Aktiv, 5 liters  
dishwasher-proof, with aluminium bottom  
**3SA051** transparent  
**3SA052** opal/translucent
- Eisbehälter für Saftkanne/Milchkanne**  
Ice Inset for Juice and Milk Dispenser  
für 2,5 l Saft / 3 l Milch  
for 2.5 l Juice / 3 l milk  
**3E1012**  
für 5 l Saft / Milch  
for 5 l Juice / milk  
**3E1019**
- Kühlakku für Saft- und Milchkanne**  
Cooling Pack for Juice and Milk Dispenser  
**3KU007**
- Zylinderdichtung**  
Cylindrical Washer  
**1DI002**
- Milchkanne ohne Deckel, Edelstahl**  
Milk Can without lid, Stainless Steel  
3 Liter / 3 liters  
**3KA008**  
5 Liter / 5 liters  
**3KA006**
- Saftzylinder spülmaschinene geeignet**  
Juice Container dishwasher-proof  
für 2,5 l Saft / for 2.5 l Juice  
**3SA037** transparent  
**3SA047** opal/translucent  
für 5 l Saft / for 5 l Juice  
**3SA011** transparent  
**3SA046** opal/translucent
- Crasheisröhre, Edelstahl, für Saftkanne**  
Crushed Ice Tube, st. st., for Juice Dispenser  
2,5 Liter / 2.5 liters  
**3CR006**  
5 Liter / 5 liters  
**3CR007**
- Crasheisröhre, Edelstahl, für Milchkanne**  
Crushed Ice Tube, st. st., for Milk Can  
3 Liter / 3 liters  
**3CR001**  
5 Liter / 5 liters  
**3CR002**
- Edelstahldeckel für Milchkanne**  
Stainless Steel Lid for Milk Can  
3 Liter / 3 liters  
**3DE025** Edelstahl/St. St.  
**3DE029** Gold  
5 Liter / 5 liters  
**3DE011** Edelstahl/St. St.  
**3DE008** Gold

- Edelstahldeckel für Saftkanne (ohne Griff)**  
Stainless Steel Lid for Juice Dispenser (without knob)  
2,5 Liter / 2.5 liters  
**3DE063** Edelstahl/St. St.  
**3DE064** Gold  
5 Liter / 5 liters  
**3DE065** Edelstahl/St. St.  
**3DE066** Gold
- Deckel für Saftkanne 9 l, Acrylglas (ohne Griff)**  
Lid for Juice Dispenser 9 liters, acrylic glass (without lid)  
**3DE049**
- Edelstahl-Tropfschale für Saftkanne/Milchkanne**  
Stainless Steel Drip Dish for Juice and Milk Dispenser  
für 2,5 Liter Saft / Milch  
for 2.5 liter Juice / milk  
**3TS023**  
für 5 Liter Saft / Milch  
for 5 liters Juice / milk  
**3TS024**
- Tropfschale für Saftkanne 9 Liter, Acrylglas (transparent)**  
Drip Dish for Juice Dispenser 9 liters, acrylic glass (transparent)  
**3TS021**
- Tropfgitter Drip Grille**  
Edelstahl/St. St.  
**3TB012**  
**3TB013** Gold
- Tropfgitter für Saftkanne 9 Liter**  
Drip Grille for Juice Dispenser 9 liters  
**3TB003** Edelstahl/St. St.  
**3TB011** Gold
- Griff (inkl. Deckelhalterung)**  
Knob (incl. lid holder)  
für 2,5 l Saft / 5 l Saft  
for 2.5 l Juice / 5 l Juice  
**EB 591 E** Edelstahl/St. St.  
**EB 591 G** Gold
- Griff für Saftkanne 9 Liter (Zylindergriffe, seitlich)**  
Knob for Juice Dispenser 9 liters (knobs, lateral)  
**BB 576 E** Edelstahl/St. St.  
**BB 576 G** Gold
- Griff für Saftkanne 9 Liter (Deckel)**  
Knob for Juice Dispenser 9 liters (Lid)  
**BB 577 E** Edelstahl/St. St.  
**BB 577 G** Gold
- Netzgerät für Rührdeckel**  
Power supply unit for Stirring Lid  
**3RU015**
- Netzgerät für Kühleinheit Aktiv**  
Power supply for Cooling Unit Milk Can Aktiv  
**3NO040**
- Edelstahldeckel Twin**  
Stainless Steel Lid Twin  
**3DE095**
- Verbindungskabel Aktiv**  
Connecting cable Aktiv  
**3RU026**
- Tropfschale Twin**  
Drip Dish Twin  
**3TS034**
- Saftzylinder 4 l Twin**  
Juice Container Twin 4 l  
**3SA054**
- Saftzylinder 5 l Twin**  
Juice Container Twin 5 l  
**3SA055**
- Eisbehälter Twin**  
Ice Inset Twin  
**8E1001**
- Crasheisröhre Twin, Edelstahl**  
Crushed Ice Tube Twin, Stainless Steel  
**3CR010**

ELEGANCE Konfitürenbars, Honigspender, Müslibars, Schälchenhalter · Jam Bars, Honey Holder, Muesli Bars, Bowl Holder

- Porzellan Behälter 0,6 Liter**  
China Cup, 0.6 liters  
**3PO040**
- Kunststoffbehälter (opal) 0,6 Liter**  
Plastic Pot (translucent) 0.6 liters ea.  
**3SA053**
- Edelstahldeckel für Jam Pot (ohne Griff)**  
Stainless Steel Lid for Jam Pot (without knob)  
**3DE078** Edelstahl/St. St.  
**3DE079** Gold
- Griff incl. Halterung**  
Knob incl. Lid holder  
**EB 591 E** Edelstahl/St. St.  
**EB 591 G** Gold
- Deckelhalterung für Jam Pot**  
Lid Holder for Jam Pot  
**3DE044**
- Gute-Nacht-Deckel für Jam Pot**  
Good-Night Lid for Jam Pot  
**3SA017**
- Müsliflöte 1,5 Liter**  
Flute 1.5 liters  
**3SA015**
- Druckdeckel für Müsliflöte**  
Press-on Lid for Muesli Flute  
**3DE054** Edelstahl/St. St.  
**3DE055** Gold
- Gute Nacht Deckel für Müsliflöte**  
Good Night Lid for Muesli Flute  
**3DE056**
- Glasschälchen 60 mm**  
Glass Bowl 60 mm  
**3GL003**
- Dosierventil Honigspender**  
Dosage Valve for Honey Holder  
**3HO020**
- Kunststoffbehälter für Honigspender**  
Plastic Pot for Honey Holder  
**3HO019**
- Edelstahltröpferschälchen**  
Drip Tray in St. St.  
**4TS001**





ELEGANCE Brotplatte · Bread Tray

 Holzplatte für Brotschale  
Wooden Tray  
3EI068

ELEGANCE Butterschale, Frischeschale, Buffet Bowl · Butter Dish, Freshness Dish, Buffet Bowl

 Eisbehälter für Frischeplatte GN  
Ice Inset for Freshness Dish  
3EI027

 Kühlakku für Butterschale / Frischeschale  
Cooling Pack for Butter / and Freshness Dish  
3KU007

 Kühlakku für 'Buffet Bowl'  
Cooling Pack for 'Buffet Bowl'  
8KU006

 Kunststoff-Dekoring für 'Buffet Bowl'  
Plastic Decoration Ring for 'Buffet Bowl'  
8ME031

 Deckel für 'Buffet Bowl' ohne Griff  
Lid for 'Buffet Bowl' without Knob  
8DE025

 Edelstahlinsatz für Butterschale  
Stainless Steel Inset for Butter Dish  
3EI008

 Griff inkl. Halterung  
Knob incl. Lid Holder  
EB 591 E Edelstahl/St. St.  
EB 591 G Gold

 Deckel  
Lid  
3DE076 Edelstahl/St. St.  
3DE077 Gold

UNISON

 Rolltop-Haube ohne Griff für '400'  
Rolltop Hood without knob for '400'  
10006

 Rolltop-Haube ohne Griff für 'GN'  
Rolltop-Hood without knob for 'GN'  
10011

 Griff für '400 / GN'  
Knob for '400 / GN'  
EB 590 E Edelstahl/St. St.  
EB 590 G Gold

 Griff für Cool '300 / 280'  
Knob for '300 / 280'  
EB 589 E Edelstahl/St. St.  
EB 589 G Gold

 Abdeckhaube ohne Griff für '230'  
Cover Hood without knob for '230'  
3DE075

 Abdeckhaube ohne Griff für '300'  
Cover Hood without Knob for '300'  
3DE035

 Abdeckhaube ohne Griff für '280'  
Cover Hood without knob for Freshness Dish '280'  
3DE069

 Aufstellarm für '300'  
Hinged Hood Device for '300'  
EB 569 E Edelstahl/St. St.  
EB 569 G Gold

 Kühlkissen  
Cooling cushion  
3KU014

 Eisbehälter für Frischeplatte '300'  
Ice Inset for Freshness Plate '300'  
3EI029

 Eisbehälter für Frischeplatte '400'  
Ice Inset for Freshness Plate '400'  
3EI030

 Eisbehälter für Frischeplatte GN  
Ice Inset for Freshness Plate GN  
3EI027

 Eisbehälter für Frischeplatte 230, 280  
Ice Inset 230, 280  
3EI028

CONNECT

 Edelstahlröhre für 'Juicer'  
Stainless Steel Tube for 'Juicer'  
3GE007

'Juicer' Acrylröhre  
'Juicer' Acrylic Container  
3PL051 3l  
3PL052 4l

 Eiseinsatz für 'Juicer'  
Edelstahl  
Ice Inset for 'Juicer'  
Stainless Steel  
3EI094

 Kühlakku für 'Juicer'  
Cooling Pack for 'Juicer'  
3KU015

 Edelstahlhahn, komplett  
Stainless Steel Faucet, complete  
BB 803 E

 Hahnkörper (Edelstahlhahn)  
Faucet Body (Stainless Steel Faucet)  
3HA020

 Haube, Griff (Edelstahlhahn)  
Cap, Handle (Stainless Steel Faucet)  
3HA019

 Scheibendichtung  
Disk shaped Washer  
3DI002

 Edelstahlröhre für 'Hopper'  
Stainless Steel Tube for 'Hopper'  
3GE004

'Hopper' Acrylröhre  
'Hopper' Acrylic Container  
3PL038 2,5l  
3PL039 3,5l  
3PL047 4,5l

 Edelstahlschütze für 'Hopper'  
Stainless Steel Shut for 'Hopper'  
3ME033

'Hopper' Paddel aus Silikon  
'Hopper' Paddle made of silicone  
3ME031

 Drehknopf, Edelstahl mit Steckachse  
Stainless Steel Turning Knob with floating axle  
3ME032

 Edelstahldeckel für 'Hopper' und 'Juicer'  
Stainless Steel Lid for 'Hopper' and 'Juicer'  
3DE094

 Edelstahldeckel für Karaffe 1,2 Liter  
Stainless steel Lid for Carafe 1.2 liters  
3ME020

 Kunststoffeinsatz für 'connect' Standfuß  
Plastic Inset for 'connect' base  
3EI093

 Porzellanbehälter 0,6 Liter  
China Cup 0.6 liters  
3PO040

 Kunststoffbehälter (opal) 0,6 Liter  
Plastic Pot (translucent) 0.6 liters  
3SA053

 Edelstahldeckel für Jam Pot (ohne Griff)  
Stainless Steel Lid for Jam Pot (without knob)  
3DE078 Edelstahl/St. St.  
3DE079 Gold

 Griff incl. Halterung für Jam Pot  
Knob for Jam Pot incl. Lid holder  
EB 591 E Edelstahl/St. St.  
EB 591 G Gold

 Gute-Nacht-Deckel für Jam Pot  
Good-Night Lid for Jam Pot  
3SA017

 Müsliflöte 1,5 Liter  
Flute 1.5 liters  
3SA015

 Druckdeckel  
Press-on Lid  
3DE054 Edelstahl/St.  
3DE055 Gold

 Gute Nacht Deckel für Müsli Flöte  
Good Night Lid for Muesli Flute  
3DE056

 Deckelhalterung, Jam Pot  
Lid Holder, Jam Pot  
3DE044

 Glaskaraffe 1,2l  
Glass Carafe 1.2l  
3GL007

 Porzellankaraffe 1,2l  
China Carafe 1.2l  
3PO039

 Kunststoffkaraffe 1,2l  
Plastic Carafe 1.2l  
3BE009

PICKNICK / EARTH

 Abdeckhaube ohne Griff '300'  
Cover Hood without Knob '300'  
3DE035

 Abdeckhaube ohne Griff '400'  
Cover Hood without Knob '400'  
3DE098

 Aufstellarm für '300 Schale'  
Hinged Hood Device for '300 Dish'  
EB 643 E

 Aufstellarm für '400 Schale'  
Hinged Hood Device for '400 Dish'  
EB 642 E

 Kühlkissen für '300 Schale'  
Cooling cushion for '300 Dish'  
3KU017

 Standfuß aus Speckstein für '300 Schale'  
Base made of Soapstone for '300 Dish'  
3ST156

 Standfuß aus Speckstein für '400 Platte'  
Base made of Soapstone for '400 Plate'  
3ST152

 Standfuß aus Weidekorb, (Kunststoff) spülmaschineneeignet '300 Schale'  
Base made of Wicker Basket (Plastic), dishwasher proof '300 Dish'  
3KO010 (beige)  
3KO015 (grau/grey)

 Standfuß aus Weidekorb, (Kunststoff) spülmaschineneeignet '400 Platte'  
Base made of Wicker Basket (Plastic), dishwasher proof '400 Plate'  
3KO009 (beige)  
3KO014 (grau/grey)

 Kühlkissen für '400 Schale'  
Cooling cushion for '400 Dish'  
3KU016

 Griff / Knob  
EB 589 E

PURE NATURE

 Tropfschale und Tropfgitter  
Drip Tray and Drip Dish  
RB 907 E

 Milchkanne ohne Deckel, Edelstahl  
Milk Can without lid, Stainless Steel  
3 Liter / 3 liters  
3KA008  
5 Liter / 5 liters  
3KA006

 Edelstahldeckel für Milchkanne  
Stainless Steel Lid for Milk Can  
3 Liter / 3 liters  
3DE025 Edelstahl / St. St.  
5 Liter / 5 liters  
3DE011 Edelstahl / St. St.

 Eiseinsatz, Milchkanne für 3 Liter / for 3 liters  
3EI044  
für 5 Liter / for 5 liters  
3EI045

 Eiseinsatz für Frischeschale  
Ice Inset for Freshness Dish  
6EI001

 Holzstandfuß für 'Bowl Bar' Buche hell  
Wooden Base for 'Bowl Bar' Natural Beech  
'Bowl Bar S'  
RB 603 X  
'Bowl Bar M'  
RB 602 X  
'Bowl Bar L'  
RB 601 X

 Holzstandfuß für Milchkanne Buche hell  
Wooden Base for Milk Can Natural Beech  
für 3 Liter / for 3 liters  
3ST134  
für 5 Liter / for 5 liters  
3ST131







 Holzstandfuß für Frischeschale Buche hell  
Wooden Base for Freshness Dish Natural Beech  
'Single S'  
3ST062  
'Single L'  
3ST061

 Kühlakku  
Cooling Pack  
3KU007

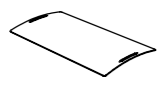











B-LINIE

- |  |  |   |   |   |
|--|--|---|---|---|
|  <p><b>Milchkanne ohne Deckel, Edelstahl</b><br/>Milk Can without lid, Stainless Steel</p> <p>3 Liter / 3 liters<br/><b>3KA008</b><br/>5 Liter / 5 liters<br/><b>3KA006</b></p> |  <p><b>Edelstahldeckel für Milchkanne</b><br/>Stainless Steel Lid for Milk Can</p> <p>3 Liter / 3 liters<br/><b>3DE025</b><br/>5 Liter / 5 liters<br/><b>3DE011</b></p> |  <p><b>Saftzylinder, spülmaschineneignend</b><br/>Juice Container, dishwasher proof</p> <p>2,5 Liter / 2.5 liters<br/><b>3SA037</b><br/>5 Liter / 5 liters<br/><b>3SA011</b></p> |  <p><b>Kunststoffdeckel ohne Griff für Saftkanne</b><br/>Plastic Lid without Knob for Juice Dispenser</p> <p>2,5 Liter / 2.5 liters<br/><b>3SA025</b><br/>5 Liter / 5 liters<br/><b>3SA002</b></p>   |  <p><b>Kugelgriff, Kunststoff verchromt für Saftkanne</b><br/>Chromed Knob, plastic for Juice Dispenser</p> <p><b>XB 515 E</b></p> |
|  <p><b>Scheibendichtung</b><br/>Disc Shaped Washer</p> <p><b>3DI 002</b></p>  |  <p><b>Non-Drip-Hahn, Kunststoff, schwarz</b><br/>Non-Drip Faucet, black Polysterene</p> <p><b>XB 802 K</b></p>   |  <p><b>Tropfgitter für Milch- und Saftkanne</b><br/>Drip Grille for Juice and Milk Dispenser</p> <p><b>3TB012</b></p>  |  <p><b>Kunststofftropfschale schwarz</b><br/>Drip Tray made of plastic, black</p> <p>2,5 Liter Saft / 3 Liter Milch<br/>2,5 liters juice / 3 liters milk<br/><b>3TS027</b><br/>5 Liter Saft / 5 Liter Milch<br/>5 liters juice / 5 liters milk<br/><b>3TS036</b></p> |  <p><b>Kunststoffbehälter (opal), 0,6 Liter</b><br/>Plastic Pot (translucent)</p> <p>2,6 Liter / 0.6 liters<br/><b>3SA053</b></p>  |
|  <p><b>Kunststoffdeckel ohne Griff für Konfitürenbehälter</b><br/>Plastic Lid without Knob for Jam Pot</p> <p><b>3SA016</b></p>   |  <p><b>Müsliflöte 1,5 Liter ohne Deckel</b><br/>Muesli Flute 1.5 liters without Lid</p> <p><b>3SA015</b></p>  |  <p><b>Kunststoffdeckel für Müsliflöte, grau</b><br/>Plastic Lid for Muesli Flute, grey</p> <p><b>Z06 6930</b></p>   |   |   |

HYGIENESCHUTZ / HYGIENIC COVER

- |  |   |  |
|--|---|--|
|   |  <p><b>Acrylglas-Haube für Hygieneschutz Raisersystem</b><br/>Acrylic Glass Board for hygienic cover for raiser system</p> <p><b>EB 718 K</b></p> |  <p><b>Acrylglas-Haube für Hygieneschutz Cool GN</b><br/>Acrylic Glass Board for hygienic cover Cool GN</p> <p><b>EB 717 K</b></p>               |
|  |  <p><b>Acrylglas-Haube für Hygieneschutz Cool 400</b><br/>Acrylic Glass Board for hygienic cover Cool 400</p> <p><b>EB 716 K</b></p>             |  <p><b>Acrylglas-Haube für Hygieneschutz Cool 300</b><br/>Acrylic Glass Board for hygienic cover Cool 300</p> <p><b>EB 715 K</b></p>            |
|  |  <p><b>Füße für Hygieneschutz (2 Stück) für Höhe 390 mm</b><br/>Stands for hygienic cover (2 pieces) for height 390 mm</p> <p><b>EB 704</b></p>  |  <p><b>Füße für Hygieneschutz (2 Stück) für Höhe 600 mm</b><br/>Stands for hygienic cover (2 pieces) for height 600 mm</p> <p><b>EB 711</b></p> |

GASTRO

- |   |  |  |   |   |
|---|--|--|---|---|
|  <p><b>Tropfgitter, rechteckig</b><br/>Drip Grille, rectangular</p> <p><b>1TB004</b></p>                           |  <p><b>Kunststofftropfschale, rechteckig</b><br/>Plastic Drip Tray</p> <p><b>1EI002</b></p>                       |  <p><b>Kühlakku</b><br/>Cooling Pack</p> <p><b>3KU007</b></p>               |  <p><b>Tropfgitter, rund</b><br/>Drip Tray, round</p> <p><b>1TS020</b></p>                           |  <p><b>Edelstahlhahn, komplett</b><br/>Stainless Steel Faucet, complete</p> <p><b>BB 803 E</b></p>   |
|  <p><b>Hahnkörper (Edelstahlhahn)</b><br/>Faucet Body (Stainless Steel Faucet)</p> <p><b>3HA020</b></p>            |  <p><b>Haube, Griff (Edelstahlhahn)</b><br/>Cap, Handle (Stainless Steel Faucet)</p> <p><b>3HA019</b></p>         |  <p><b>Scheibendichtung</b><br/>Disc shaped Washer</p> <p><b>3DI002</b></p> |  <p><b>Edelstahlbehälter 2 Liter</b><br/>Stainless Steel Container 2 liters</p> <p><b>1BE023</b></p> |  <p><b>Edelstahldeckel für Edelstahlbehälter Milch</b><br/>Stainless Steel Lid for Stainless Steel Container Milk</p> <p><b>1DE009</b></p> |
|  <p><b>Edelstahldeckel für Zuckerbehälter</b><br/>Stainless Steel Lid for Sugar Container</p> <p><b>1DE028</b></p> |  <p><b>Kunststoffbehälter für Streuzucker</b><br/>Plastic Container for Granulated Sugar</p> <p><b>1SA001</b></p> |  |   |   |

## FRILICH Buffetplaner auf www.frilich.com

Vorhandene Tischflächen optimal mit dem benötigten Buffetangebot ausstatten oder für ein benötigtes Buffetangebot die optimale Buffetfläche gestalten: Mit dem FRILICH Buffetplaner haben Sie hierfür ab sofort eine Gestaltungshilfe, die Ihnen unter [www.frilich.com](http://www.frilich.com) zur Verfügung steht. Dieses Modul unterstützt Sie in sieben Schritten bei der Planung und Einrichtung eines perfekt kombinierten und effizient in Szene gesetzten Buffets.

- 2 Komponenten:** Wählen Sie aus den FRILICH Buffetlinien die Produkte aus, die Sie auf Ihrem Buffet platzieren möchten. Beachten Sie, dass Ihnen unterschiedliche Buffetdesigns zur Verfügung stehen, die Ihnen die Gestaltung nach individuellen Vorstellungen möglich macht. Sobald Sie das von Ihnen ausgewählte Produkt anklicken, erscheint dieses zur Positionierung auf der zuvor bemaßten Tischskizze. Unter dem Menüpunkt 'Sonstiges' können auch Buffetprodukte selbst definiert und bemaßt werden, die nicht im FRILICH Sortiment enthalten sind.

**Components:** Choose from the various FRILICH product lines, which items you wish to place on your buffet table. Please note that you may select different buffet designs to make an arrangement according to your individual needs and ideas. When you select a particular product from the left hand side of the components list, it will appear for positioning on the pre-selected table area. You can also reserve space for your own products on the table layout, by selecting the menu item 'Other' (last item under the heading 'Components').

- 1 Tisch:** Zur Auswahl steht Ihnen die Gestaltung eines runden/ovalen oder eines rechteckigen Buffettisches. Bestimmen Sie Breite und Tiefe in Millimeter. Eine maßstabstreue Tischskizze wird zur Bestückung des Buffets auf Ihrem Bildschirm dargestellt.

**Table:** You may choose or select a rectangular, round or oval table. Fill in the dimensions box and then click OK. A true to scale image of your table will be generated and shown on the screen.

## FRILICH Buffet Planner at www.frilich.com

Equip existing table layout area with the required buffet items or calculate the required space for your buffet display products. The FRILICH buffet planner offers a presentation tool, which is available to use at [www.frilich.com](http://www.frilich.com). This module assists you in planning and setting up a perfect matching combination – seven steps to create your individual buffet.

- 3 Platzieren und Drehen auf der Tischskizze:** Die von Ihnen ausgewählten Produkte erscheinen auf dem Tisch als Strichzeichnung in Vogelperspektive. Positionieren und drehen Sie mit Hilfe der Maus das Produkt auf der Tischskizze. Achten Sie auf die Höhenmaße der Produkte. Damit Ihre Produktplatzierung anwenderfreundlich bleibt, werden z.B. niedrigere vorne und höhere Buffetprodukte dahinter platziert.

### Placing and rotating items on the table sketch/image:

The products that you have selected appear from a bird's eye view and in the form of line drawings. You can move and rotate the selected 'part' by clicking on the green navigation buttons, which will appear when you move the arrow cursor/mouse over the drawing. Please note the height dimension of the articles. In order to provide a user-friendly product placement, small buffet items are placed in the front with the bigger items arranged behind.

- 6 Stückliste/Alles entfernen/Druck:** Wenn Sie Ihr Buffet fertig gestaltet haben, können Sie die Stückliste nochmal separat als Druckliste aufrufen. Für einen 2. Versuch lässt sich die Liste aber auch noch einmal komplett entfernen.

**Parts list/Remove all/Print:** Part List / Remove all / Print After arranging your buffet, you can again separately access the parts list for printing. You can also remove items individually at any time and start again.

- 7 Anfrage senden:** Die Buffetprodukte sind platziert, der Präsentationstisch optimal von Ihnen ausgestattet. Bestätigen Sie mit dem Button 'Anfrage senden' und FRILICH erhält automatisch die Produktliste zur Erstellung Ihres Angebotes. Selbstverständlich stets unverbindlich!

**Request a quote:** The buffet items are placed and you have optimally equipped the table area. By clicking on the 'Request a Quote' button, the FRILICH team or one of our sales partners will submit an offer of the items chosen by you in the parts list. Of course the sales quote is without any commitment.

- 5 Stückliste (Optionen):** Die Stückliste ermöglicht Ihnen Ihre Produktwahl weiter zu präzisieren. Entscheiden Sie, ob das Produkt in der Ausführung 'Gold' gelistet werden soll. Oder möchten Sie das FRILICH Kühlkissensystem zur ausgewählten Servierplatte hinzufügen?

**Parts list (Options):** On some products you will be able to select further options i. e. product choice.

| Item | Product Name  | Dimensions                               | Image |
|------|---|--|-------|
| 1.   | RB 609 E 003 pure nature - Servierplatte mit Porzellanplatte voll, S Edelstahl-Raiser | Höhe 80 mm, Breite 310 mm, Tiefe 310 mm  |       |
| 2.   | RB 624 E 002 pure nature - Buffet Bowl 1,5 Liter, M Edelstahl-Raiser                  | Höhe 280 mm, Breite 210 mm, Tiefe 210 mm |       |
| 3.   | RB 623 E 001 pure nature - Buffet Bowl 3,5 Liter, L Edelstahl-Raiser                  | Höhe 385 mm, Breite 210 mm, Tiefe 210 mm |       |

- 4 Stückliste:** Ausgewählte Produkte werden in die Stückliste aufgenommen. Artikelnummer, Produktbeschreibung und weitere Details zu Ihrer Auswahl stehen Ihnen in dieser Liste zur Verfügung.

**Parts list:** All the selected products will be included in a 'Parts List' together with item code, detailed description and product pictures.









## Allgemeine Verkaufs- und Lieferbedingungen

Die folgenden Allgemeinen Verkaufs- und Lieferbedingungen gelten nur für den kaufmännischen und öffentlichen Bereich gemäß § 24 Ziff. 1 und 2 AGB Gesetz und finden, soweit nichts anderes vereinbart, auf für alle künftigen Geschäfte mit uns Anwendung.

### I. Angebot und Vertragsabschluss

Unsere Angebote sind freibleibend. Der Vertrag kommt erst durch unsere Auftragsbestätigung oder durch Ausführung des Auftrags zustande. Abweichungen von diesen Verkaufsbedingungen bedürfen unserer ausdrücklichen, schriftlichen Anerkennung.

### II. Preise, Zahlungsbedingungen

Die Preise sind netto zuzüglich des jeweils gültigen Mehrwertsteuersatzes. Unsere Rechnungen sind zahlbar innerhalb von 30 Tagen nach Rechnungsdatum ohne jeden Abzug. Bei Bezahlung innerhalb von 10 Tagen nach Rechnungsdatum gewähren wir, falls es nicht anders vereinbart ist, 2 % Skonto, sofern vorhergehende Rechnungen ausgeglichen sind. Wir sind bei Überschreitung dieser Zahlungsfrist unter Vorbehalt der Geltendmachung eines weiteren Verzugschadens ohne Mahnung berechtigt, Zinsen in Höhe von 2 % über dem Diskontsatz der Deutschen Bundesbank zu verlangen. Sollten wir in der Zeit zwischen Vertragsabschluss und Lieferung unsere Preise allgemein ermäßigen oder erhöhen, so wird der am Tage des Versands gültige neue Preis berechnet. Falls sich der Preis erhöht, ist der Besteller berechtigt, innerhalb von 14 Tagen nach Mitteilung der Preiserhöhung vom Vertrag zurückzutreten. Wir behalten uns vor, Zahlungen zur Begleichung der ältesten Rechnungsposten zuzüglich der darauf aufgelaufenen Verzugszinsen und Kosten zu verwenden, und zwar in der Reihenfolge: Kosten, Zinsen, Hauptforderung.

Die Aufrechnung mit anderen als unbestritten oder rechtskräftig festgestellten Gegenansprüchen sowie die Ausübung von Leistungsverweigerungs- und Zurückbehaltungsrechten gegen Kaufpreisforderungen bedürfen unserer Zustimmung. Bei Zweifeln an der Zahlungsfähigkeit eines Bestellers, insbesondere bei Zahlungsrückstand, sind wir vorbehaltlich weitergehender Ansprüche berechtigt, für weitere Lieferungen Vorauszahlungen und Sicherheiten zu verlangen sowie eingeräumte Zahlungsziele zu widerrufen. Bei Erstaufträgen behalten wir uns vor, nur gegen Vorauskasse oder per Nachnahme Waren auszuliefern.

### III. Lieferung, Vertragshindernisse

Lieferfristen sind unverbindlich, soweit nicht im Einzelfall ausdrücklich Gegenteiliges vereinbart ist. Teillieferungen sind zulässig. Bei Vereinbarung eines festen Liefertermins hat der Besteller im Falle unseres Verzugs eine angemessene Nachfrist von mindestens 4 Wochen zu setzen. Erfolgt die Lieferung auch bis zum Ablauf der Nachfrist nicht, hat der Besteller das Recht zum Rücktritt vom Vertrag. Nimmt der Besteller die Ware nicht ab, sind wir berechtigt, nach Setzen einer Nachfrist von 10 Tagen vom Vertrag zurückzutreten oder Schadensersatz wegen Nichterfüllung zu verlangen. Im letzteren Fall sind wir berechtigt, entweder ohne Nachweis eines Schadens 25 % des Kaufpreises oder Ersatz des tatsächlich entstandenen Schadens zu verlangen. Die Rückgabe von Sonderanfertigungen jeglicher Art sowie Artikeln außerhalb unseres Standard-Programmes ist nicht möglich. Darunter fallen auch jene Artikel, die speziell im Kundenauftrag bei dem Vorlieferanten bestellt werden müssen. Alle Bestellungen werden unter dem Vorbehalt der allgemeinen Herstellungsmöglichkeit angenommen. Höhere Gewalt jeder Art berechtigt uns, von dem Vertrag ganz oder teilweise zurückzutreten, ohne dass der Besteller ein Recht auf Schadensersatz hat. Der Besteller ist bei Eintreten derartiger Ereignisse berechtigt, nach Ablauf einer angemessenen Nachfrist vom Vertrag zurückzutreten. Weitergehende Rechte kann der Besteller nicht geltend machen. Zu Teillieferungen und Teilleistungen sind wir jederzeit berechtigt. Der Versand erfolgt im Inland bis EUR 150,- immer ab Werk. Bei Rechnungen über EUR 150,- Warenwert liefern wir im Inland frei Haus. Außerhalb Deutschlands liefern wir immer ab Werk. Der Versand erfolgt auf Rechnung und Gefahr des Käufers. Für Beschädigungen und Verluste während des Transports haften wir nicht. Sofern nicht anders vereinbart, wählen wir Versand und Verpackung nach bestem Ermessen. Eine Versicherungspflicht übernehmen wir nicht. Auf schriftliches Verlangen des Käufers wird die Ware jedoch gegen Transportschäden und andere Schäden versichert.

### IV. Eigentumsvorbehalt

Alle von uns gelieferten Waren bleiben unser Eigentum, solange wir aus der Geschäftsverbindung mit dem Käufer noch Zahlungsansprüche gegen ihn haben. Mit der Annahme unserer Ware tritt der Käufer bis zur völligen Bezahlung unserer Forderungen die ihm aus der Weiterveräußerung der in unserem Eigentum stehenden Waren gegen seine Abnehmer erwachsenden Forderungen mit allen Nebenrechten an uns ab. Zugriffe auf die in unserem Eigentum oder Miteigentum stehenden Waren und uns abgetretene Forderungen sind uns vom Käufer unverzüglich anzuzeigen.

### V. Mängel- und Schadenshaftung

Mängelrügen werden nur berücksichtigt, wenn sie unverzüglich, schriftlich, spätestens jedoch innerhalb von 14 Tagen nach Erhalt der Ware unter Einsendung von Belegen, Mustern sowie der Angabe von Rechnungsnummer und Rechnungsdatum erhoben werden. Transportschäden müssen umgehend beim Wareneingang, spätestens jedoch innerhalb von 2 Arbeitstagen schriftlich reklamiert werden. Die Rücksendung beanstandeter Ware darf nur mit unserer Zustimmung erfolgen.

### VI. Garantie

Die Garantie erstreckt sich auf den Ersatz oder die Instandsetzung fehlerhafter Teile. Nicht unter die Garantie fallen Schäden, die zurückzuführen sind auf: unsachgemäße Bedienung des Gerätes, insbesondere falsche oder unzureichende Reinigung, natürliche Abnutzung, normalen Verschleiß. Unsere Garantie gilt nur innerhalb der Bundesrepublik Deutschland gegenüber Kunden, die das Gerät als erster oder von einem unserer Wiederverkäufer von uns beziehen. Die Garantie beginnt mit dem Lieferdatum, sie beträgt 12 Monate. Werden Bedienungs- und Reinigungsanweisungen nicht befolgt, entfällt jede Gewährleistung. Beanstandungen jeglicher Art müssen uns innerhalb von 8 Tagen nach Erhalt der Ware bzw. unmittelbar nach Auftreten des Schadens schriftlich angezeigt werden. Die unter die Gewährleistung fallenden Teile werden nicht berechnet, während Transportkosten, Arbeitszeit und Reisezeit zu unseren Standardsätzen zu bezahlen sind. Ein über die Garantiebedingungen hinausgehender Anspruch, insbesondere auf Ersatz von Folgeschäden, besteht nicht.

### VII. Erfüllungsort und Gerichtsstand, Wirksamkeitsklausel, Datenverwendung

Erfüllungsort für die Leistung des Bestellers ist Gießen. Ist der Besteller Vollkaufmann, so ist der Gerichtsstand Gießen oder nach unserer Wahl der allgemeine Gerichtsstand des Bestellers. Sind oder werden einzelne Bestimmungen dieser Bedingungen oder des Liefergeschäftes unwirksam, so wird dadurch die Wirksamkeit der übrigen Bestimmungen nicht berührt. Eine wirksame Regelung gilt als durch eine solche Regelung ersetzt, die dem wirtschaftlichen Zweck der unwirksamen Regelung am nächsten kommt und wirksam ist. Wir sind berechtigt, die bezüglich der Geschäftsbeziehung oder im Zusammenhang mit dieser erhaltenen Daten über den Besteller, gleich ob diese vom Besteller selbst oder von Dritten stammen, im Sinne des Bundesdatenschutzgesetzes zu verarbeiten.

Frilich GmbH  
Buseck, September 2019

### Preise:

Dieser Katalog mit seinen ausgewiesenen Preisen hat Gültigkeit ab 1. September 2019. Alle vorherigen Kataloge und Preise verlieren ab diesem Zeitpunkt ihre Gültigkeit. Die Katalogpreise gelten solange der Warenvorrat reicht, längstens jedoch bis Erscheinen des Nachfolge-Kataloges bzw. einer Nachfolge-Preisliste.

### Zum Katalog:

Nachdruck, auch auszugsweise, bedarf unserer schriftlichen Genehmigung. Die Fotos bzw. Zeichnungen stammen aus Eigenproduktion. Alle Rechte daraus bleiben vorbehalten. Alle Größenangaben sind Circa-Angaben, Änderungen behalten wir uns vor. Für Irrtümer und Druckfehler übernehmen wir keine Gewähr.

## Standard Terms of Sales and Delivery

The following Standard Terms of Sales and Delivery apply only to commercial and public sectors according to article 24, sections 1 and 2 of the laws governing Standard Terms and Conditions of Trade (AGB Gesetz) in Germany and, if no other provisions are made, shall apply to all future business with us.

### I. Quotations and Conclusion of Contract

1. Our quotations are non-binding and subject to change without notice. The contract shall not become effective until we acknowledge and confirm the order, in writing, or the order is executed. We reserve the right to impose a 5 % export charge (max. EUR 80,-) on export orders for goods within Europe and a 5 % export charge (max. EUR 150,-) on goods exported outside Europe. This covers special packing, handling of export documents, bank charges etc.  
2. Any deviation from these conditions of sales must be approved by us in writing.

### II. Prices, Terms of Payment

1. All prices are net.  
2. Payment has to be made according to the confirmation. Should the buyer fail to meet our payment terms within the agreed period, we are authorized, without issuing a specific reminder, to charge interest of 2 % above the discount rate of the German Bundesbank and we reserve the right to claim any further damages resulting from arrears.  
3. Should it arise that, in the period between confirmation of an order and delivery, we are obliged to lower or raise prices, the price to be paid is the new price, valid on the day the goods are dispatched. Should the price be raised, the buyer has the right to withdraw from contract within 14 days after notification of any price rise.  
4. We reserve the right to make use of payments made, including any default interest and costs accrued on them, to settle longest outstanding accounts in the following order: costs, interest, principal debt.  
5. Counterbalancing price claims with opposing claims that have proven indisputable and legally valid as well as the exercising of rights to refuse payment and withhold goods require our consent.  
6. If the customer's ability to pay is in doubt, especially if payments are in arrears, we may, failing more extensive claims, demand payment in advance and security for further orders; we may also revoke granted credit terms.  
7. On orders placed for the first time, we reserve the right to deliver the goods against prepayment.

### III. Delivery, Force Majeure

1. Delivery deadlines are non-binding, provided nothing has been explicitly agreed to the contrary in a particular case. The seller is authorized to deliver by instalments. We assume no responsibility for events or circumstances occurring due to force beyond our control, not even when binding time limits have been agreed on. When a fixed delivery deadline has been set which the seller fails to meet, buyer is to extend the deadline by an appropriate period of at least 6 weeks. Should seller still fail to deliver the goods within the extension period, the buyer has the right to withdraw from the contract.  
2. Should buyer refuse to take delivery, seller is authorized to withdraw from the contract after extending the delivery deadline by 10 days or to claim damages on the grounds of non-fulfillment. In the latter case, the seller is authorized with or without presentation of proof or damage to claim 25 % of purchasing price or compensation for the damage actually sustained.  
3. Articles on special offer cannot be exchanged. The seller refuses to accept both the return of any non-standard-line goods specially manufactured and any articles not included in our standard stock programme. This also includes articles which require special ordering from outside suppliers on a client's behalf.  
4. Dispatched is always ex works at the buyer's risk and on account. If there is a danger that the buyer may have reason to delay the dispatch of goods, he must warn seller of this danger when dispatch terms are agreed on. Seller assumes no responsibility for damage to and loss of goods in transit. Frilich reserve the right to choose how goods are to be packed and dispatched unless alternative arrangements have been made. Seller assumes no responsibility for insurance coverage. Should, however, buyer express in writing the wish to have goods insured against damage caused in transit or due to other factors, we will gladly comply.

### IV. Ownership Proviso

1. We reserve the ownership of goods delivered until the amounts charged have been paid in full. Invoices are regarded as paid when we are in receipt of the amounts due.  
2. Should buyer fall into arrears of fail to fulfil obligations arising from the ownership proviso agreed on, seller is authorized, even without making use of right to withdraw from contract and without extending deadline, to demand that, at the expense of the buyer, the goods in his possession be returned to him and that he collect them from the buyer. Further to this, all outstanding balances must be settled by the buyer immediately. Seller's reacquisition of the goods delivered does not classify as a withdrawal from contract. After giving buyer fair warning and setting an adequate deadline, we are authorized to make as good a direct sales as possible of the goods previously dispatched, adding a supplementary charge to the purchasing price. Buyer must bear all costs of our reacquiring and reselling the goods. Realization costs are 20 % of proceeds from sale of the goods, inclusive of turnover tax, and do not require verification.

### V. Liability for Defects and Damages

1. Complaints will be taken into account only if they are made immediately in writing or, at the latest, within 8 days of receipt of the goods, and are sent to seller along with receipts and samples plus number and date of invoice. Where damage has been caused in transit, complaints must be lodged in writing immediately on receipt of goods by buyer or, at the latest, within 2 workdays.  
2. Goods which are the object of complaint may not be returned to us unless our consent has been given.

### VI. Warranty

1. The warranty covers the replacement or repair of defective parts. Excluded from this warranty are damages which result from:  
a) Improper handling of the device, especially improper or insufficient cleaning.  
b) Natural, normal wear and tear  
2. Our warranty only applies within the Federal Republic of Germany, for customers who have purchased the device directly from us or from one of our dealers. The warranty begins on the date of delivery and extends over 12 months.  
3. Disregard to operating and cleaning instructions results in the cancellation of this warranty.  
4. Complaints of any kind must be made to us, in writing, within 14 days after receipt of the goods or immediately upon occurrence of the damage.  
5. Parts included in the warranty will not be invoiced, whereas shipping costs, labour and travel time are to be paid at our standard rates.  
6. No claims beyond those stated in this warranty may be made, especially regarding compensation for subsequent damage.

### VII. Place of Fulfilment and Seat of Jurisdiction

1. The place of fulfilment from which services to seller are operated is Giessen, Germany. If buyer is an accredited businessman, the responsible legal authority is Giessen or, at our discretion, the buyer's local court.

Frilich GmbH  
Buseck, September 2019

### Prices

This catalogue and the prices given in it are effective as from 01-09-2019. All previous catalogues and former prices are invalid from this date on. The catalogue prices remain valid as long as present stocks last or, until a new catalogue, with a new price list, is published.

### Use of Data

Copying of catalogue date or any extracts from catalogues must have our consent in writing. Photographs and illustrations are Frilich productions. All rights to them are reserved and are subject to copyright.

We accept no responsibility for typographical or clerical errors in the catalogue. All dimensions given are approximate; we strictly reserve the right to make any alterations, without giving prior notice.