



Sedie & tavoli[®] 2019
26Q16 & f9A01!

AR[®] ROSSANESE

L'esperienza tecnica quarantennale ci ha permesso di offrire prodotti dove decisamente la qualità prevale sul prezzo.

La nostra gamma di sedie e tavoli è sufficientemente ampia da soddisfare le esigenze dell'arredo interno ed esterno. I materiali utilizzati sono di primaria scelta questo perché il nostro obiettivo è quello di mantenere una proficua collaborazione con Voi clienti, sarà inoltre nostra premura aggiornarVi periodicamente sui nuovi modelli.

Siamo sempre a disposizione nel recepire consigli e informazioni tendenti a migliorare l'offerta.

The forty years of technical experience has enabled us to offer products where quality prevails on the price considerably.

Our range of chairs and tables are large enough to meet the needs of the interior and exterior. The materials used are of primary choice, this is because our goal is to maintain a fruitful collaboration with customers, will also be our pleasure to update them regularly on new models.

We are always on hand to incorporate information and advice aimed at improving the offer.

Tutti i diritti sono riservati. Nessuna parte del catalogo può essere riprodotta o diffusa con un mezzo qualsiasi, fotocopie, microfilm o altro, senza il permesso scritto dell'autore.

All right reserved. No one part of this catalogue can be reproduced or spread by all means, photocopy, microfilm or others without the written permission of the author.

Printed by Ancora Arti Grafiche - Via B. Crespi, 30 - 20159 Milano (Mi) Italy
Tel. +39 02 60 85 221 - email: arti.grafiche@ancoralibri.it - www.ancoraprint.it

SOMMARIO/SUMMARY

Esterno / Outdoor pp. 11-114

Interno / Indoor

Sedie & Poltroncine / *Chairs & Armchairs* pp. 115-237

Poltrone & Divani / *Armchairs & Sofas* pp. 238-269

Sedute ufficio / *Office chairs* pp. 270-283

Sgabelli & Pouf / *Bar stools & Ottoman* pp. 284-313
pp. 117-133

Tavoli / *Tables* pp. 314-360

Tavolini / *Coffee tables* pp. 361-368

Basi e piani per tavoli / Table bases and tops

Basi per esterno / *Outdoor bases* pp. 369-385

Basi per interno / *Indoor bases* pp. 386-399

Piani per esterno / *Outdoor tops* pp. 400-407

Piani in HPL / *HPL tops* pp. 408-409

Piani per interno / *Indoor tops* pp. 410-411

Arredi luminosi / Light furniture pp. 415-424

INDICE / INDEX

SALOTTI PER ESTERNO OUTDOOR LIVING	Pag. 12	Pag. 13	Pag. 14						
	Pag. 15	Pag. 16	Pag. 17						
Pag. 17	Pag. 18		Pag. 18						
Pag. 19	LETTINI / SUNBED								
Pag. 100						Pag. 100	Pag. 101	Pag. 102	Pag. 102
796 - CSL8						1130 - CS21	1554 - A12	1053 - SUN	1546 - JY6F
SEDIE & POLTRONE CHAIRS & ARMCHAIRS	Pag. 20	Pag. 20	Pag. 21	Pag. 22	Pag. 22	Pag. 23	Pag. 25	Pag. 26	Pag. 27
	1636 - E71	1637 - E72	1635 - E70	1641 - SU8A	1640 - SU8	1631 - CH51	1606 - MB4	051 - MC1415	899 - HA30
	Pag. 27	Pag. 30	Pag. 32	Pag. 34	Pag. 34	Pag. 34	Pag. 37	Pag. 37	Pag. 38
	894 - HA50	1581 - MC039	1493 - QF16	810 - C78A	809 - C78	996 - C22	1670 - UEOW	1699 - UE03	1670 - BA01

INDICE / INDEX











Pag. 39  SET 1181 - CA43A	Pag. 39  SET 1297 - CF60	Pag. 40  1242 - CH1	Pag. 42  1189 - T12	Pag. 44  725 - Y19	Pag. 46  1480 - XH3	Pag. 48  1477 - XH8	 Pag. 50  1690 - TG2
---	---	--	--	--	--	--	--

 Pag. 50  1689 - TG1	Pag. 51  1089 - CT619	Pag. 52  1475 - 9A	Pag. 54  1474 - 9C	Pag. 58  1501 - 9D	Pag. 60  1502 - 9E	Pag. 64  1152 - M44	Pag. 66  1298 - M18	Pag. 67  998 - SH15	Pag. 68  818 - U12
--	--	---	---	---	---	---	--	--	---























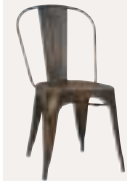
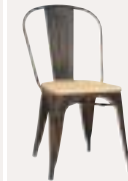





























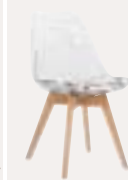
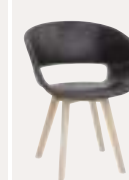





Pag. 69  819 - U13	Pag. 70  1054 - LIB	Pag. 72  1156 - WAM	Pag. 74  1483 - A11	Pag. 76  883 - 180P	Pag. 77  1269 - OW139	Pag. 78  1277 - M25	Pag. 78  802 - Y012	 Pag. 79  1141 - 48L	 Pag. 80  1579 - TJE
---	---	---	---	---	---	--	---	---	---

 Pag. 81  1580 - TVL	Pag. 82  690 - PP	Pag. 83  691 - PL	Pag. 85  1145 - 047	Pag. 86  1161 - E80	Pag. 86  1162 - E80A	Pag. 86  062 - AM10	Pag. 86  063 - AM09	Pag. 87  060 - AM03	Pag. 87  056 - AM02
--	--	--	--	--	---	---	--	--	--

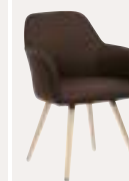
Pag. 87  055 - AM01	Pag. 88  718 - MCR138	Pag. 88  719 - MCR139	Pag. 89  472 - P77	Pag. 89  473 - P78	Pag. 90  015 - ALR92	Pag. 91  016 - ALR95	Pag. 92  946 - 38A	Pag. 93  947 - 39A	Pag. 94  498 - L80801
---	--	--	---	---	---	--	---	---	--

Pag. 95  499 - L80804	Pag. 104  020 - ALR12	Pag. 105  024 - ALR04	Pag. 105  026 - ALR06	Pag. 106  035 - ALW01	Pag. 106  037 - ALW04	Pag. 106  043 - ALW12	Pag. 106  039 - ALW06	Pag. 107  038 - ALW05	Pag. 107  040 - ALW07
---	--	--	--	--	--	---	--	--	--

INDICE / INDEX

Pag. 109  001 - ALL01	Pag. 109  004 - ALL04	Pag. 109  005 - ALL05	Pag. 109  006 - ALL06	Pag. 110  454 - ALL33	Pag. 110  007 - ALL07	Pag. 116  976 - ET53	Pag. 118  978 - EM35W	Pag. 122  1100 - M51	Pag. 125  971 - MC001B
Pag. 126  969 - MC001T	Pag. 126  1066 - MC001TW	Pag. 129  1427 - 01N	Pag. 129  1428 - 01NW	Pag. 130  968 - MC001D	Pag. 130  1077 - MC001DW	Pag. 134  1464 - 05A	Pag. 135  1431 - MC001A	Pag. 135  1432 - MC001AW	 Pag. 136 1661 - DA3
 Pag. 136 1662 - DA4	 Pag. 137 1652 - J02	 Pag. 138 1638 - DH2	 Pag. 139 1186 - HT35	 Pag. 140 1188 - HT36	 Pag. 142 1673 - PA1	 Pag. 142 1674 - PA2	 Pag. 143 1650 - PA3	 Pag. 143 1692 - PA4	 Pag. 144 1041 - C25
 Pag. 146 1124 - M07	 Pag. 147 1036 - G02	 Pag. 148 1037 - G03	 Pag. 150 1484 - AR7	 Pag. 152 1585 - S37R	 Pag. 153 1584 - S37	 Pag. 153 1582 - S37A	 Pag. 154 1014 - JK5	 Pag. 155 1683 - ST23	 Pag. 156 1525 - D24
 Pag. 158 1322 - Z87	 Pag. 160 1593 - XH2P	 Pag. 161 1144 - 62F	 Pag. 161 1320 - W2C	 Pag. 162 1489 - YG99	 Pag. 163 1587 - YG101	 Pag. 164 1586 - YG100	 Pag. 165 1492 - YG94	 Pag. 166 1423 - YM2	 Pag. 166 1422 - YM1
 Pag. 167 1626 - EV10	 Pag. 168 1682 - ST77	 Pag. 169 1438 - C50W	 Pag. 169 1439 - C50P	 Pag. 170 1335 - W58	 Pag. 172 1335 - W58	 Pag. 174 1334 - B91	 Pag. 176 1524 - D22	 Pag. 176 1523 - D23	 Pag. 178 1185 - PW07

INDICE / INDEX

Pag. 180  1150 - 72B	Pag. 181  1193 - PW72	Pag. 182  1148 - 72K	Pag. 183  1057 - PW022	Pag. 183  1092 - FL08W	Pag. 185  1103 - NET08	Pag. 186  1419 - ITP3	Pag. 187  926 - JY05	Pag. 187  1035 - D060	Pag. 189  1451 - 7BD
--	--	---	---	---	---	---	---	--	---

Pag. 189  1456 - 30D	 Pag. 191  1615 - T0P8	Pag. 192  1528 - T07	 Pag. 193  1693 - F450	 Pag. 194  1601 - 82P	 Pag. 194  1602 - 82C	Pag. 195  821 - RF49C	Pag. 196  825 - RF49P	Pag. 198  1105 - RF91	Pag. 199  1020 - SS95
--	--	---	--	---	---	---	--	--	--

 Pag. 200  1613 - T0P6	 Pag. 201  1614 - T0P7	Pag. 202  1485 - F50	Pag. 203  1482 - F442	Pag. 204  949 - F400	Pag. 205  948 - F503	Pag. 206  824 - RF97	Pag. 208  837 - C4135	Pag. 209  608 - C2406	Pag. 211  593 - C2842
---	---	--	---	--	--	---	---	---	---

Pag. 212  1329 - CQ04	Pag. 214  1259 - M0120C	Pag. 215  888 - ISA	Pag. 215  889 - PC492	 Pag. 216  1589 - YG103	Pag. 217  1486 - YG91	 Pag. 218  1625 - EV24	 Pag. 219  1623 - EV03	 Pag. 219  1686 - EVC03	 Pag. 220  1622 - EV07
---	--	--	--	---	--	---	--	---	--

 Pag. 220  1687 - EVC07	 Pag. 221  1624 - EV012	 Pag. 221  1685 - EVC12	Pag. 222  893 - CT390	Pag. 223  074 - CT123	Pag. 224  922 - CT20	Pag. 225  626 - KG1C	Pag. 226  219 - 1153-1	Pag. 227  697 - Y30S	Pag. 228  616 - PP8165
---	---	---	--	--	---	--	---	---	---









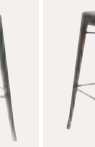

Pag. 229  590 - K18C	Pag. 230  710 - KC07	Pag. 231  343 - AB47T	Pag. 232  1101 - BS001MC	Pag. 233  263 - AB027T	Pag. 234  670 - PE001T	Pag. 235  871 - MC4C	Pag. 236  267 - AB001T	Pag. 237  083 - AR100
--	---	--	---	---	---	--	---	--

INDICE / INDEX







POLTRONE ARMCHAIRS	 Pag. 191	 Pag. 238	 Pag. 240	 Pag. 244	 Pag. 246	 Pag. 248	 Pag. 249	 Pag. 250	 Pag. 252
	1616 - TOP9	1520 - S8V	1605 - 06P	1121 - C12P	1191 - S01	1657 - FU2P	1664 - TF21	625 - C2816	836 - C4041

 Pag. 254	 Pag. 255	 Pag. 256	 Pag. 258	 Pag. 259	 Pag. 260	 Pag. 264	 Pag. 266	 Pag. 268	 Pag. 269
1633 - GU34	1660 - DA2	1659 - DA1	1612 - TOP5	1240 - V61	432 - X17P	1509 - D062	1340 - FE1	1618 - TOP11	1000 - JY06

POOF / SGABELLI OTTOMAN / BARSTOOLS	 Pag. 242	 Pag. 117	 Pag. 127	 Pag. 131	 Pag. 184	 Pag. 313	 Pag. 120	 Pag. 120	 Pag. 124
	1603 - 06T	1084 - BT18	1264 - 010T	1263 - 009T	1143 - M2	1123 - D600	977 - BT503	955 - MC012	1295 - BT03

 Pag. 127	 Pag. 127	 Pag. 129	 Pag. 131	 Pag. 131	 Pag. 133	 Pag. 139	 Pag. 140	 Pag. 149	 Pag. 149
966 - MC012T	1060 - MC012PT	1496 - BT04	1061 - MC012D	1062 - MC012DT	1417 - BM37	1440 - HT38	1321 - HT37	1258 - G04L	1038 - G04

 Pag. 153	 Pag. 154	 Pag. 155	 Pag. 191	 Pag. 284	 Pag. 285	 Pag. 286	 Pag. 287	 Pag. 288	 Pag. 289
1583 - S847	1015 - JK5B	1684 - ST23A	1617 - TOP10	1651 - J01G	1007 - F600	1497 - K31	1303 - PW026	1655 - FU95	1500 - K32

 Pag. 290	 Pag. 290	 Pag. 291	 Pag. 292	 Pag. 293	 Pag. 294	 Pag. 295	 Pag. 296	 Pag. 297	 Pag. 298
1639 - EV37	1627 - EV36	646 - AB047BB	442 - BB010	932 - K38	443 - CT123-1	815 - C77	221 - B1201	838 - C4063	1630 - EV23

INDICE / INDEX

Pag. 299  513 - A661A	Pag. 300  223 - B010	Pag. 301  245 - B030	Pag. 302  512 - A174	Pag. 303  997 - K3001	Pag. 304  1113 - BY035	 Pag. 305 1566 - V12	Pag. 306  933 - K08	Pag. 307  934 - K00	Pag. 308  1031 - 795
--	---	---	---	--	---	--	--	--	---

Pag. 309  595 - T010	Pag. 310  528 - 238A	Pag. 311  531 - 219B	Pag. 312  419 - IF216
---	---	---	--

PANCHE & DIVANI BENCHES & SOFAS	Pag. 263  1331 - CQ02	Pag. 213  1332 - CQ13
------------------------------------	---	--

 Pag. 239 1604 - 06S	 Pag. 244 1122 - C12S	 Pag. 246 1192 - S02	 Pag. 259 1241 - V61D	 Pag. 261 475 - X17D2
---	---	--	--	---

 Pag. 265 1510 - D080	SEDUTE E UFFICIO OFFICE CHAIRS	 Pag. 270 1643 - 4BC2	 Pag. 271 1642 - 4B2	 Pag. 272 762 - LS31	 Pag. 273 763 - LS30	 Pag. 274 764 - LS11	 Pag. 275 765 - LS10	 Pag. 276 1237 - HM2
---	-----------------------------------	--	---	---	--	---	---	---









 Pag. 276 1238 - MM2	 Pag. 276 1239 - VM2	 Pag. 277 1234 - HL1	 Pag. 277 1235 - ML1	 Pag. 277 1236 - VL1	 Pag. 278 529 - W81	 Pag. 279 671 - W03	 Pag. 280 1628 - EV11	 Pag. 281 1491 - YG98	 Pag. 282 1126 - K03
--	---	---	---	---	--	---	--	--	---

 Pag. 283 669 - WX910	TAVOLI / TABLES	 Pag. 28 906 - HA38	 Pag. 35 128 - MA01A	 Pag. 35 1526 - HY18	 Pag. 75 1300 - M40	 Pag. 84 1044 - S15	 Pag. 96 560 - CTS0022	 Pag. 96 561 - MCQ 80	 Pag. 108 109 - MTW006A
---	-----------------	--	---	---	--	---	---	--	--









INDICE / INDEX

Pag. 108  678 - MTW011A	Pag. 112  092 - MTA003A	Pag. 112  097 - MTA013A	Pag. 113  102 - MTA016K	Pag. 118  1265 - 70W	 Pag. 119  1649 - 80WA	Pag. 121  1266 - CT60	 Pag. 123  1575 - 36WA	Pag. 126  1262 - 236D	Pag. 128  1267 - GT24
---	--	--	--	---	--	---	--	--	--

Pag. 130  956 - 36D	Pag. 132  1268 - GT28	Pag. 314  1665 - TF22	Pag. 316  1442 - A58	Pag. 318  1442 - A58	Pag. 320  1445 - A75G
---	--	--	---	--	--

Pag. 322  1324 - A75	 Pag. 324  1608 - TOP1	 Pag. 326  1658 - RI9A	 Pag. 328  1609 - TOP2	 Pag. 330  1610 - TOP3
---	---	---	--	---

 Pag. 332  1694 - DE93T	 Pag. 333  1594 - DE86T	Pag. 334  1539 - WL01	Pag. 335  1447 - T21	 Pag. 336  1621 - MIT83
--	---	--	--	---

 Pag. 336  1675 - MIT82	 Pag. 337  1677 - MIT10	 Pag. 337  1676 - MIT67	 Pag. 338  1634 - GU33	Pag. 339  1450 - 28DT
---	---	---	---	--

Pag. 340  1458 - 18DT	Pag. 342  1457 - 65DT	Pag. 344  1455 - 75DTG	Pag. 348  1459 - 88DT	Pag. 350  1460 - 78DT
--	--	---	---	--

INDICE / INDEX

Pag. 352 1461 - 03DT	Pag. 355 509 - TB015	Pag. 356 1562 - TB08	Pag. 357 938 - K54	Pag. 358 1040 - G06	Pag. 359 944 - Z152
-----------------------------	-----------------------------	-----------------------------	---------------------------	----------------------------	----------------------------

Pag. 360 537 - CS205	Pag. 360 538 - CS206	 Pag. 363 1653 - B01T	Pag. 367 1565 - TS7
-----------------------------	-----------------------------	-----------------------------	----------------------------

BASI / TABLE BASES	 Pag. 370 1648 - EG3	 Pag. 370 1644 - S10	 Pag. 370 1646 - EG2	 Pag. 370 1645 - EG1	 Pag. 371 1680 - BB07
---------------------------	----------------------------	----------------------------	----------------------------	----------------------------	-----------------------------

Pag. 372 980 - TB015S	Pag. 373 1354 - T40RU	Pag. 374 363 - 6032I	Pag. 374 364 - 6032C	Pag. 374 365 - 340N	Pag. 374 365 - 340N	Pag. 374 365 - 340N	Pag. 376 411 - 6028I	Pag. 376 414 - 6028C	Pag. 376 360 - 340N
------------------------------	------------------------------	-----------------------------	-----------------------------	----------------------------	----------------------------	----------------------------	-----------------------------	-----------------------------	----------------------------

Pag. 376 360 - 340N	Pag. 376 360 - 340N	Pag. 378 165 - CI159	Pag. 378 166 - CI160	Pag. 378 779 - TB131	Pag. 379 159 - CI110A	Pag. 380 402 - 6033I	Pag. 380 773 - 341C	Pag. 380 403 - 341M	Pag. 380 403 - 341M
----------------------------	----------------------------	-----------------------------	-----------------------------	-----------------------------	------------------------------	-----------------------------	----------------------------	----------------------------	----------------------------

Pag. 382 156 - CI129	Pag. 382 157 - CI130	Pag. 383 366 - 313	Pag. 384 1351 - T11BR	Pag. 385 170 - CI155-4	Pag. 386 153 - CA102	Pag. 387 155 - CA102B	Pag. 388 611 - F3	Pag. 390 973 - TP	Pag. 390 973 - TP
-----------------------------	-----------------------------	---------------------------	------------------------------	-------------------------------	-----------------------------	------------------------------	--------------------------	--------------------------	--------------------------

Pag. 392 180 - CS2014	Pag. 394 136 - B	Pag. 395 134 - C	Pag. 396 143 - OA	Pag. 397 1412 - TB77	Pag. 399 1349 - B80
------------------------------	-------------------------	-------------------------	--------------------------	-----------------------------	----------------------------

PIANI PER ESTERNO OUTDOOR TOPS	Pag. 400 TEAK	Pag. 401 ACCIAIO	Pag. 401 IN LEGNO
---	----------------------	-------------------------	--------------------------

INDICE / INDEX

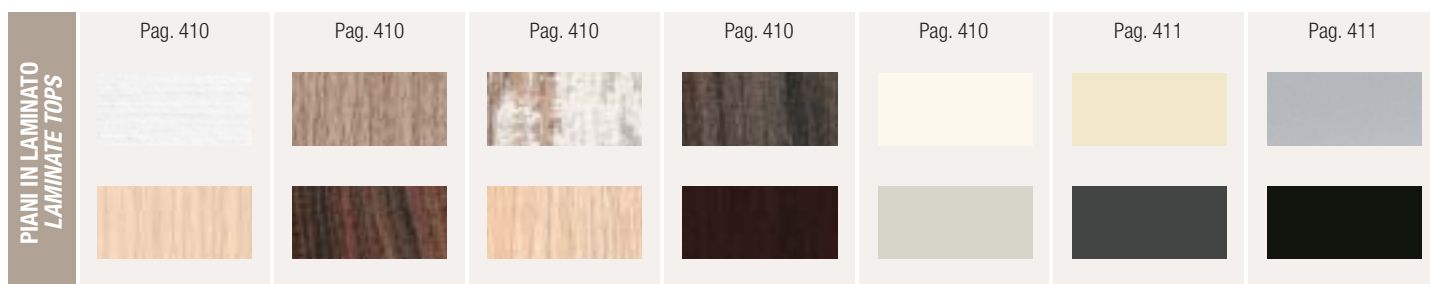
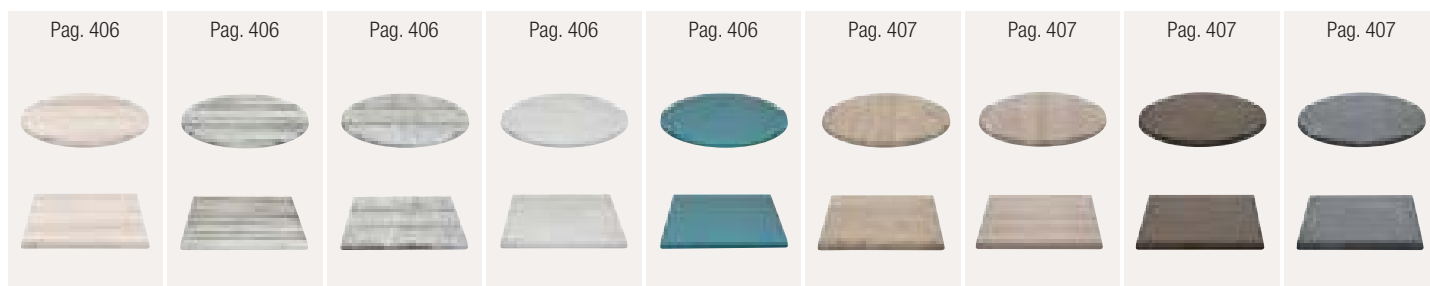
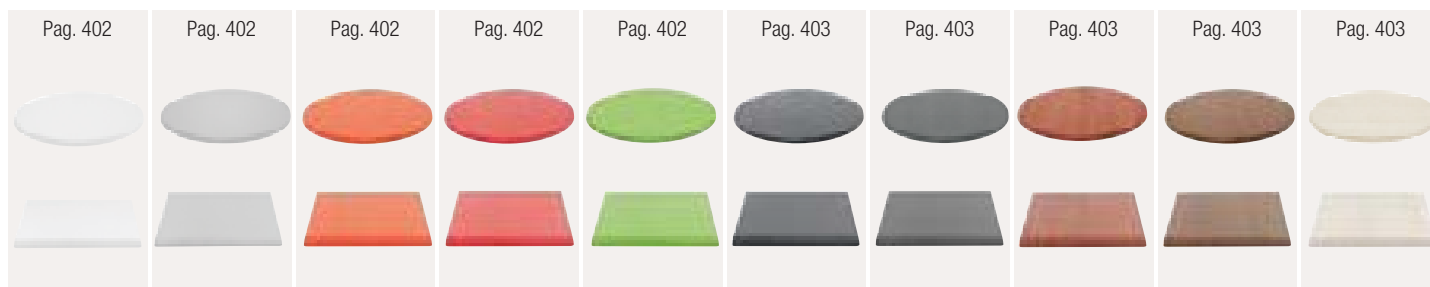

Su richiesta / On demand

PIANI IN MELAMMINICO & LAMINATO **PERSONALIZZATI**
CUSTOM MADE MELAMINE & LAMINATED TOPS

PIANI IN STRATIFICATO HPL **PERSONALIZZATI**
CUSTOM MADE HPL PRESSURE LAMINATE TOPS



Esterno

Outdoor



1176 - MA56
(L78 x P78 x H70 cm)



1177 - MA55
(L76 x P78 x H70 cm)



1178 - MA54S
1179 - MA54D
(L82 x P78 x H70 cm)



1180 - MA57
(L78 x P78 x H70 cm)



1175 - MA53A
(L78 x P78 x H30 cm)



1194 - MA53B
(L76 x P76 x H31 cm)

Struttura in alluminio verniciato,
cuscini in tessuto
*Aluminum frame, powder coating,
fabric cushions*



SET 1512 - A4P

POLTRONA ARMCHAIR
(L75 x P71 x H64 cm)

DIVANO SOFA
(L162 x P71 x H64 cm)

TAVOLINO COFFEE TABLE
(L100 x P55 x H45 cm)

Struttura in alluminio verniciato, cuscini in tessuto
Aluminum frame, powder coating, fabric cushions



☐ POLTRONA *ARMCHAIR*
1114 - HM05A
(L81 x P70 x H62,5 cm)

☐ DIVANO *SOFA*
1115 - HM05B
(L144 x P70 x H62,5 cm)

☐ TAVOLINO *COFFEE TABLE*
1116 - HM05E
(L100 x P60 x H41 cm)

Struttura in alluminio satinato,
cuscini in tessuto

*Satin aluminum frame,
fabric cushions*



POLTRONA *ARMCHAIR*
1599 - S1S
(L50 x P55 x H67 cm)

DIVANO *SOFA*
1598 - S1D
(L113 x P55 x H67 cm)

TAVOLINO *COFFEE TABLE*
1600 - S1F
(L44 x P68 x H32 cm)

struttura / frame



W T

Struttura in polipropilene
con fibra di vetro,
cuscini idrorepellenti

*Polipropylene frame with fiber
glass waterproof cushions*

NEW



SET 1632 - CH14

POLTRONA *ARMCHAIR*
(L75 x P67 x H61 cm)

DIVANO *SOFA*
(L184 x P67 x H61 cm)

TAVOLINO *COFFEE TABLE*
(L57 x P120 x H44 cm)

Struttura in alluminio verniciato, cuscini in tessuto
Aluminum frame powder coating, fabric cushions

struttura / frame



W T



POLTRONA *ARMCHAIR*
394 - WS091P
(L68 x P77 x H80 cm)

TAVOLINO *COFFEE TABLE*
393 - WS091T
(L100 x P60 x H44 cm)

DIVANO *SOFA*
395 - WS091D
(L141 x P77 x H80 cm)

Struttura in alluminio, rivestimento in piattina di polietilene / *Aluminum frame, polyethylene strap covering*



W

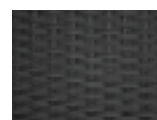

N



Struttura in alluminio verniciato,
rivestimento in piattina di polietilene, piano in teak,
cuscini idrorepellenti

*Aluminum frame, powder coating,
polyethylene strap covering,
waterproof cushions*

1296 - BAR1

POLTRONA *ARMCHAIR*
(L60 x P65 x H81 cm)

DIVANO *SOFA*
(L130 x P65 x H81 cm)

TAVOLINO *COFFEE TABLE*
(L110 x P70 x H45 cm)



POLTRONA *ARMCHAIR*
571 - CS0109A
(L76 x P70 x H67 cm)

DIVANO *SOFA*
750 - CS0109
(L140 x P70 x H67 cm)

TAVOLINO *COFFEE TABLE*
575 - CS0109T
(L70 x P70 x H29 cm)

Struttura in alluminio, rivestimento
in piattina di polietilene

*Aluminum frame, polyethylene
strap covering*



W



N

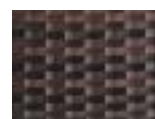

M



POLTRONA *ARMCHAIR*
280 - GF06681
(L65 x P66 x H88 cm)

DIVANO *SOFA*
283 - GF06682
(L115 x P66 x H88 cm)

TAVOLINO *COFFEE TABLE*
281 - GF0669
(L92 x P54 x H47 cm)

Struttura in alluminio,
rivestimento in piattina di polietilene

*Aluminum frame,
polyethylene strap covering*



W



N



M



□ ANGOLO *CORNER*
572 - CS0109CR
(L70 x P70 x H67 cm)



□ POLTRONA S/B *CHAIR W/A*
573 - CS0109M
(L60 x P70 x H67 cm)



□ POGGIPIEDI *OTTOMAN*
574 - CS0109MS
(L70 x P70 x H29 cm)



□ TAVOLINO *COFFEE TABLE*
575 - CS0109T
(L70 x P70 x H29 cm)



W

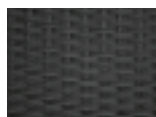

N



M

Struttura in alluminio,
rivestimento in piattina di polietilene
*Aluminum frame,
polyethylene strap covering*

NEW



1636 - E71

Struttura in alluminio verniciato, rivestimento in piattina di polietilene
Aluminum frame powder coating, polyethylene strap covering

h A h h 
76cm 49cm 45cm 45cm

 
N T



1637 - E72

Struttura in alluminio verniciato, seduta in textilene,
schienale in corda di polietilene
*Aluminum frame powder coating, textilene seat,
polyethylene cord backrest*

h A h h 
76cm 49cm 45cm 45cm

NEW



1635 - E70

Struttura in alluminio verniciato, rivestimento in
piattina di polietilene, cuscino idrorepellente

*Aluminum frame powder coating, polyethylene strap
covering, waterproof cushion*



89cm 47cm 47cm 47cm



N T

NEW



1641 - SU8A

Struttura in alluminio verniciato, seduta e schienale in textilene

Aluminum frame, powder coating, seat and backrest in textilene



struttura / frame



1640 - SU8

Struttura in alluminio verniciato, seduta e schienale in textilene

Aluminum frame, powder coating, seat and backrest in textilene



struttura / frame



NEW



1631 - CH51

Struttura in alluminio verniciato,
rivestimento e cuscino in textilene

*Aluminum frame powder coating,
textylene covering and cushion*

h A h h
84cm 47cm 48cm 48cm

struttura / frame

□ ■
W T

tessuto / fabric



LG

DG

T

NEW



1607 - MB3

Struttura in alluminio verniciato,
rivestimento e cuscino in textilene e olifem

*Aluminum frame powder coating,
textylene with olifem covering and cushion*

h A h h
88cm 58cm 51cm 43cm

tessuto / fabric



LG

G

M

NEW



1606 - MB4

Struttura in alluminio verniciato,
rivestimento e cuscino in textilene e olifem

*Aluminum frame powder coating,
textylene with olifem covering and cushion*



77cm 49cm 47cm 45cm

tessuto / fabric



LG



G



M



051 - MC1415

Struttura pieghevole in alluminio verniciato,
braccioli in legno, tessuto in textilene

*Folding aluminum frame, powder coating,
wood arms, textilene fabric*

h A h h
91cm 43cm 44cm 47cm

□ ■ ■
W V G



899 - HA30



894 - HA50



Struttura in alluminio satinato,
seduta e schienale in materiale composito
*Brushed aluminum frame,
seat and backrest in composite material*



906 - HA38
(L80 x P80 x H76 cm) KD

907 - HA39
(L180 x P90 x H76 cm) KD

Struttura in alluminio satinato,
piano in materiale composito
*Brushed aluminum frame,
top in composite material*



SGABELLO *BAR STOOL*
897 - HA93
Struttura in alluminio satinato,
seduta e schienale in materiale composito
*Brushed aluminum frame,
seat and backrest in composite material*

112cm 41cm 43cm 76cm KD

TAVOLO *TABLE*
905 - HA37
Struttura in alluminio satinato,
piano in materiale composito
*Brushed aluminum frame
top in composite material*
(L70 x P70 x H110 cm) KD



□ PANCA BENCH
1117 - HM04B
(L165 x P41 x H46 cm) KD



□ TAVOLO TABLE
907 - HA39
(L180 x P90 x H76 cm) KD

Struttura in alluminio satinato,
piano in materiale composito
*Satin aluminum frame,
top and seat in composite material*

NEW



1581 - MC039

Struttura in alluminio verniciato

Aluminum frame, powder coating

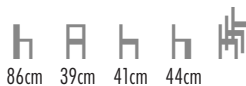





1493 - QF16

Struttura in metallo verniciato

Metal frame, powder coating



78,5cm 44cm 41cm 46cm



W

N

G

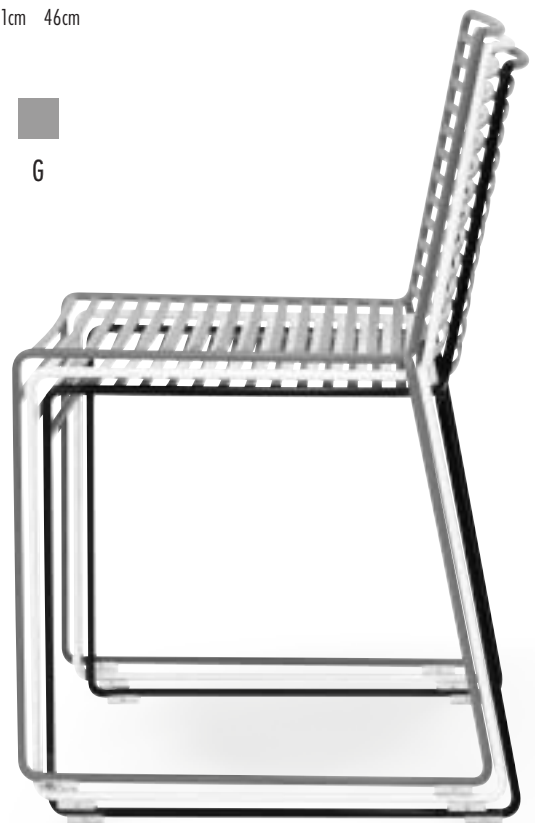

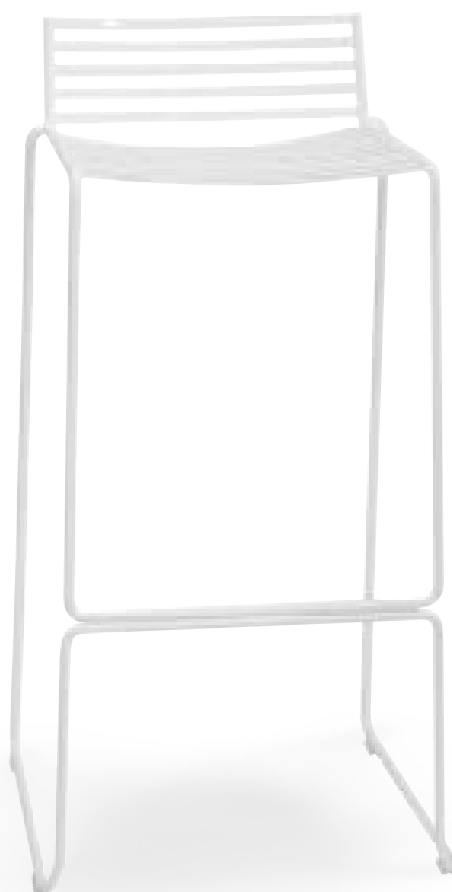
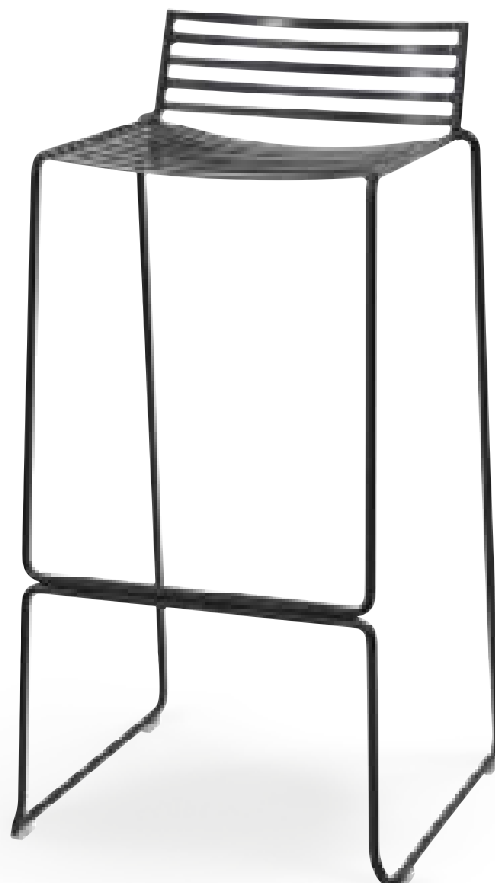
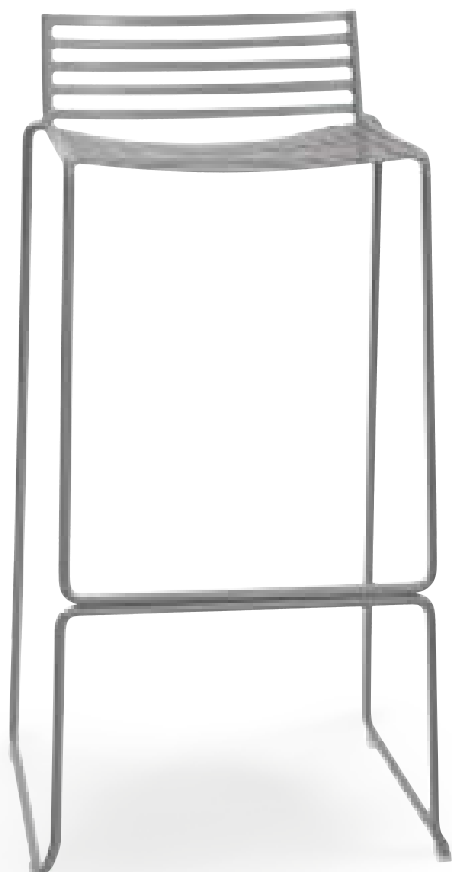

1498 - QF17

Struttura in metallo verniciato

Metal frame, powder coating

86,5cm 37cm 33cm 74cm

W N G



809 - C78

Struttura in metallo verniciato

Metal frame, powder coating



90cm 42cm 48cm 44,5cm



810 - C78A

Struttura in metallo verniciato

Metal frame, powder coating



90cm 42cm 48cm 44,5cm



996 - C22

Struttura in metallo verniciato

Metal frame, powder coating



90cm 45cm 44cm 45cm



128 - MA01A (Ø60 x H72 cm) KD
129 - MA01B (Ø70 x H72 cm) KD



Struttura in metallo verniciato
Metal frame, powder coating

130 - MA09A (70 x 70 x H72 cm) KD
131 - MA09B (80 x 80 x H72 cm) KD



1526 - HY18 (70 x 70 x 74 cm)
1508 - HY17 (80 x 80 x 74 cm)



Struttura in metallo verniciato
Metal frame, powder coating



NEW

I T O[®]
ITALIAN ORIGINAL



1568 - QT60
L60 x P60 x H75 cm

1569 - QT70
L70 x P70 x H75 cm

1570 - QT80
L80 x P80 x H75 cm

1695 - HQT60
L60 x P60 x H110 cm

1696 - HQT70
L70 x P70 x H110 cm

Struttura in metallo verniciato
Metal frame, powder coating



SET 1697 - VEC1
Tavolo + 4 sgabelli / *Table + 4 barstools*

TAVOLO *TABLE*
L75 x P75 x H110 cm

SGABELLO



77cm 32cm 32cm

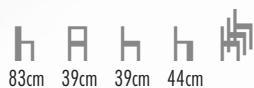

1670 - UEOW

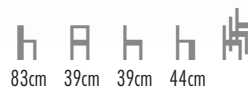

1699 - UE03



1698 - UE02



Struttura in metallo verniciato
Metal frame, powder coating



NEW



□ DIVANO SOFA

1672 - BA02

Struttura in metallo verniciato, cuscino in ecopelle

Metal frame, powder coating, PU cushion

(L125 x P50 x H85 cm)

□ TAVOLINO COFFEE TABLE

1671 - BA03

Struttura in metallo verniciato, piano in HPL

Metal frame, powder coating, HPL top

(Ø 75 x H44 cm)



1670 - BA01

Struttura in metallo verniciato, cuscino in ecopelle

Metal frame, powder coating, PU cushion

h A h h
79cm 55cm 42cm 47cm



1669 - BA22

Struttura in metallo verniciato, cuscino in ecopelle

Metal frame, powder coating, PU cushion

h A h h
96cm 47cm 39cm 68cm



SET 1181 - CA43A

Struttura pieghevole in metallo verniciato

Folding metal frame, powder coating

□ TAVOLO TABLE
(Ø 60 x H71 cm)

□ SEDIA CHAIR

h A h h
80cm 41cm 46cm 45cm



SET 1297 - CF60

Struttura pieghevole in metallo verniciato e materiale composito

Folding metal frame and composite material

□ TAVOLO TABLE
(Ø 60 x H71 cm)

□ SEDIA CHAIR

h A h h
80cm 41cm 46cm 45cm



1242 - CH1

Struttura in metallo verniciato, rivestimento in filo di polietilene

Metal frame, powder coating, polyethylene thread covering







Designed by Claudio Francesco Bellini



□ SEDIA CHAIR
1189 - T12

Struttura in polipropilene / Polypropylene frame

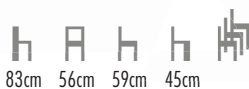





725 - Y19

Struttura in polipropilene
con fibra di vetro

*Polypropylene frame with
fiberglass*

h A h h 
79cm 46cm 45cm 46,5cm







1480 - XH3

Struttura in polipropilene

Polypropylene frame

h A h h
77,5cm 43,5cm 40cm 46cm







1477 - XH8

Struttura in polipropilene

Polypropylene frame





NEW



1689 - TG1



1690 - TG2



Struttura in polipropilene
Polypropylene frame



1691 - TG3

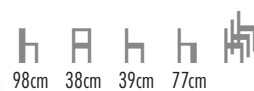



1089 - CT619

Struttura in polipropilene

Polypropylene frame and shell



81cm 44cm 41cm 45cm



W N G





1475 - 9A
 Struttura in polipropilene con fibra di vetro
Polipropylene frame with fiber glass

h A h h h
 77cm 43,5cm 41,5cm 44cm







1474 - 9C

Struttura in polipropilene con fibra di vetro

Polipropylene frame with fiber glass







1476 - 9B

Struttura in polipropilene con fibra di vetro

Polipropylene frame with fiber glass



96cm 36cm 34cm 75,5cm







1501 - 9D

Struttura in polipropilene con fibra di vetro

Polipropylene frame with fiber glass







1502 - 9E

Struttura in polipropilene con fibra di vetro

Polipropylene frame with fiber glass

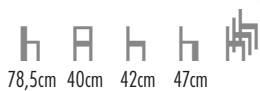





1503 - 9F

Struttura in polipropilene con fibra di vetro

Polipropylene frame with fiber glass



98cm 34,5cm 35cm 75cm







1152 - M44

Struttura in polipropilene

Polypropylene frame

h A h h
80cm 41cm 46cm 45cm





1151 - M42
 Struttura in polipropilene
Polypropylene frame

h A h h
 94cm 39cm 40cm 64cm





1298 - M18

Struttura in polipropilene

Polypropylene frame

h A h h 
77cm 44cm 46cm 45cm

   
W N G P



998 - SH15
 Struttura in polipropilene
Polypropylene frame





818 - U12

Struttura in polipropilene

Polypropylene frame

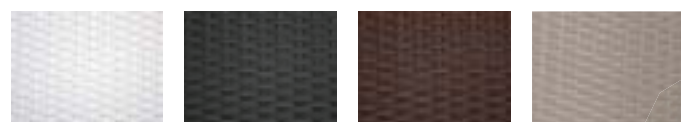

W

N

M

J



819 - U13
Struttura in polipropilene
Polypropylene frame

h A h h 
88cm 44cm 41,5cm 45cm



W

N

M

J



□ SEDIA CHAIR
1054 - LIB
Struttura in polipropilene
Polypropylene frame

 80cm 45cm 51cm 45cm



 W N A LV G BO BE





□ POLTRONCINA *ARMCHAIR*
1156 - WAM

Struttura in polipropilene
frame

79cm 56cm 51cm 45cm



W N A LV G BO BE





1483 - A11
Struttura in polipropilene
Polypropylene frame

h A h h 
88cm 45cm 42,5cm 46cm

    
W N G M PE



1300 - M40

Struttura e piano in polipropilene

Polypropylene frame and top
(L70 x P70 x H74 cm)





883 - 180P

Struttura in polipropilene
con fibra di vetro

*Polypropylene frame
with fiberglass*

h A h h h
83cm 40cm 40cm 44,5cm

W N R V



1269 - OW139

Struttura in polipropilene

Polypropylene frame



76cm 47cm 40cm 45,5cm



W N A G



1277 - M25

Struttura in polipropilene

Polypropylene frame



802 - Y012

Struttura in polipropilene
con fibra di vetro

*Polypropylene frame with
fiberglass*



NEW



1141 - 48L

Struttura in polipropilene

Polipropilene frame

h A h h 
81cm 39cm 47cm 65cm

W R

NEW



1579 - TJE

Gambe in alluminio,
scocca in polipropilene

*Aluminum legs,
polypropylene shell*

h A h h H
82cm 40cm 41cm 45cm

W N R G V

NEW



1580 - TVL

Gambe in alluminio,
scocca in polipropilene

*Aluminum legs,
polypropylene shell*





690 - PP

Gambe in alluminio,
scocca in polipropilene

*Aluminum legs,
polypropylene shell*



82cm 44cm 41cm 44cm



W N R A LV L-B



691 - PL

Gambe in alluminio,
scocca in polipropilene

*Aluminum legs,
polypropylene shell*

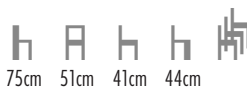

75cm 51cm 41cm 44cm





807 - TIB

Struttura in alluminio, *Aluminum legs,*
 piano in polipropilene *polypropylene table top*

(L75 x P75 x H75 cm)



921 - A75

Struttura in alluminio, *Aluminum legs,*
 piano in polipropilene *polypropylene table top*

(P75 x L75 x H75 cm)

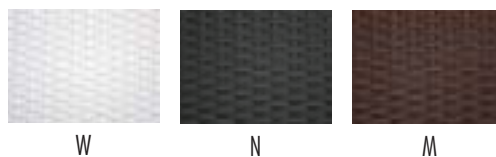

1044 - S15

Struttura in polipropilene
Polypropylene frame
 (L78,5 x P78,5 x H75,5 cm)

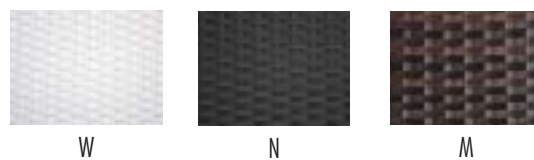



1145 - 047

Struttura in polipropilene

Polypropylene frame



81cm 50cm 62cm 45cm



R V



1161 - E80

88cm 39cm 42cm 44,5cm

Struttura in alluminio verniciato bambù,
tessuto in textilene

*Painted aluminum frame, bamboo look,
textylene fabric covering*



1162 - E80A

88cm 39cm 42cm 44,5cm



062 - AM10

89cm 39cm 42cm 44,5cm

Struttura in alluminio verniciato bambù,
rivestimento in piattina di nylon

*Aluminum frame, bamboo look,
nylon strap covering*



063 - AM09

89cm 39cm 42cm 44,5cm



060 - AM03

Struttura in alluminio verniciato bambù,
tessuto in textilene

*Aluminum frame, bamboo look,
textylene fabric covering*

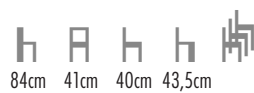

84cm 41cm 40cm 43,5cm



056 - AM02

Struttura in alluminio verniciato bambù,
tessuto in textilene

*Aluminum frame, bamboo look,
textylene fabric covering*

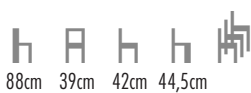

88cm 39cm 42cm 44,5cm



055 - AM01

Struttura in alluminio verniciato bambù,
tessuto in textilene

*Aluminum frame, bamboo look,
textylene fabric covering*

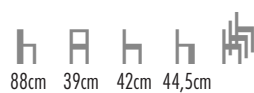

88cm 39cm 42cm 44,5cm



718 - MCR138

Struttura in alluminio verniciato,
seduta e schienale in piattina di polietilene

*Aluminum frame, polyethylene
strap covering*



91cm 41cm 41cm 46cm



719 - MCR139

Struttura in alluminio verniciato,
seduta e schienale in piattina di polietilene

*Aluminum frame, polyethylene
strap covering*



91cm 45cm 41cm 46cm



472 - P77

Struttura in alluminio, rivestimento
in piattina di polietilene

*Aluminum frame, polyethylene
strap covering*

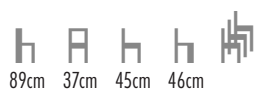

473 - P78

Struttura in alluminio, rivestimento
in piattina di polietilene

*Aluminum frame, polyethylene
strap covering*

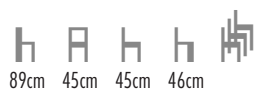



015 - ALR92

Struttura in alluminio, rivestimento
in piattina di polietilene

*Aluminum frame, polyethylene
strap covering*

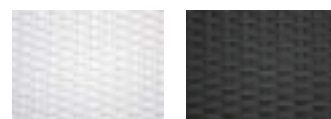

W

N



016 - ALR95

Struttura in alluminio, rivestimento
in piattina di polietilene

*Aluminum frame, polyethylene
strap covering*

h A h h 
91cm 41cm 39,5cm 47cm



946 - 38A

Struttura in alluminio, rivestimento
in piattina di polietilene

*Aluminum frame, polyethylene
strap covering*



85cm 44cm 44cm 45,5cm



W



N

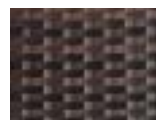

M



947 - 39A

Struttura in alluminio, rivestimento
in piattina di polietilene

*Aluminum frame, polyethylene
strap covering*



 85cm 47cm 43cm 45,5cm



W

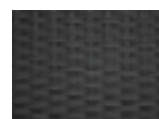

N

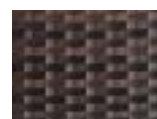

M



498 - L80801

Struttura in alluminio, rivestimento
in piattina di polietilene

*Aluminum frame, polyethylene
strap covering*



86cm 41cm 43cm 46cm

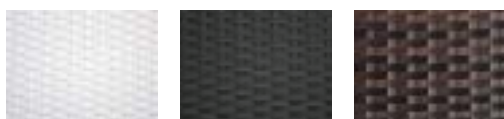

W

N

M



499 - L80804

Struttura in alluminio, rivestimento
in piattina di polietilene

*Aluminum frame, polyethylene
strap covering*



87cm 47cm 45cm 44cm



W

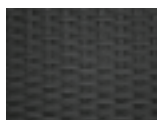

N



M



560 - CTS0022
(L70 x P70 x H75 cm) KD

Struttura in alluminio, rivestimento in piattina di polietilene, piano in vetro temperato, base in alluminio

Aluminum frame, polyethylene strap covering, tempered glass top, aluminum base



W

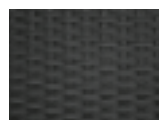

N



M



561 - MCQ 80 (L80 x P80 x H75 cm) KD

562 - MCQ 90 (L90 x P90 x H75 cm) KD

563 - MCQ 140 (L140 x P80 x H75 cm) KD

Struttura in alluminio, rivestimento in piattina di polietilene, piano in vetro temperato

Aluminum frame, polyethylene strap covering, tempered glass top



W

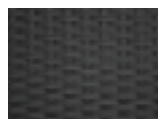

N

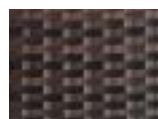

M



□ SGABELLO *BAR STOOL*
548 - CBC0001

Struttura in alluminio, rivestimento in
piattina di polietilene

*Aluminum frame, polyethylene strap
covering*

h A h h
107cm 43cm 55cm 76cm



□ TAVOLO *TABLE*
565 - CBT0002

Struttura in alluminio, rivestimento in piattina di polietilene,
base in alluminio, piano in vetro temperato

*Aluminum frame, polyethylene strap covering,
aluminum base, tempered glass top*
(P80 x L80 x H110 cm) KD



W



N

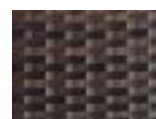

M



547 - 0624G

Struttura in alluminio, rivestimento in piattina di polietilene

Aluminum frame, polyethylene strap covering

76cm 33cm

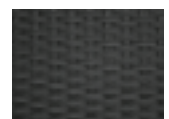

W

N

M



943 - CBC0004

Struttura in alluminio, rivestimento in piattina di polietilene

Aluminum frame, polyethylene strap covering

105cm 40cm 40cm 76cm

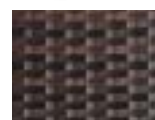
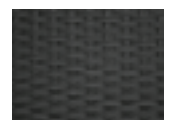

W

N

M



SET 566 - 0624T

- Tavolo + 4 sgabelli / Table + 4 bar stools
Struttura in alluminio, rivestimento in piattina di polietilene, piano in vetro temperato
Aluminum frame, polyethylene strap covering, tempered glass top
(L77 x P77 x H110 cm)



W



N



M



796 - CSL8

Struttura anatomica in alluminio,
rivestimento in piattina di polietilene

*Anatomical aluminum frame,
polyethylene strap covering*

(L200 x P63 cm)



W



N

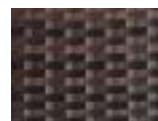

M



1130 - CS21

Struttura in alluminio,
rivestimento in piattina di polietilene

*Aluminum frame,
polyethylene strap covering*

(L193 x P64 x H62 cm)



W



N

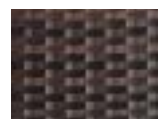

M



1554 - A12

Struttura in alluminio verniciato, rivestimento in textilene

Aluminum frame, powder coating, textilene covering

(L194 x P67 cm)





1053 - SUN

Struttura in polipropilene con ruote posteriori,
tessuto in textilene

*Polypropylene frame with back wheels,
textylene fabric*

(L193 x P57 x H29 cm) 

Tessuto / fabric

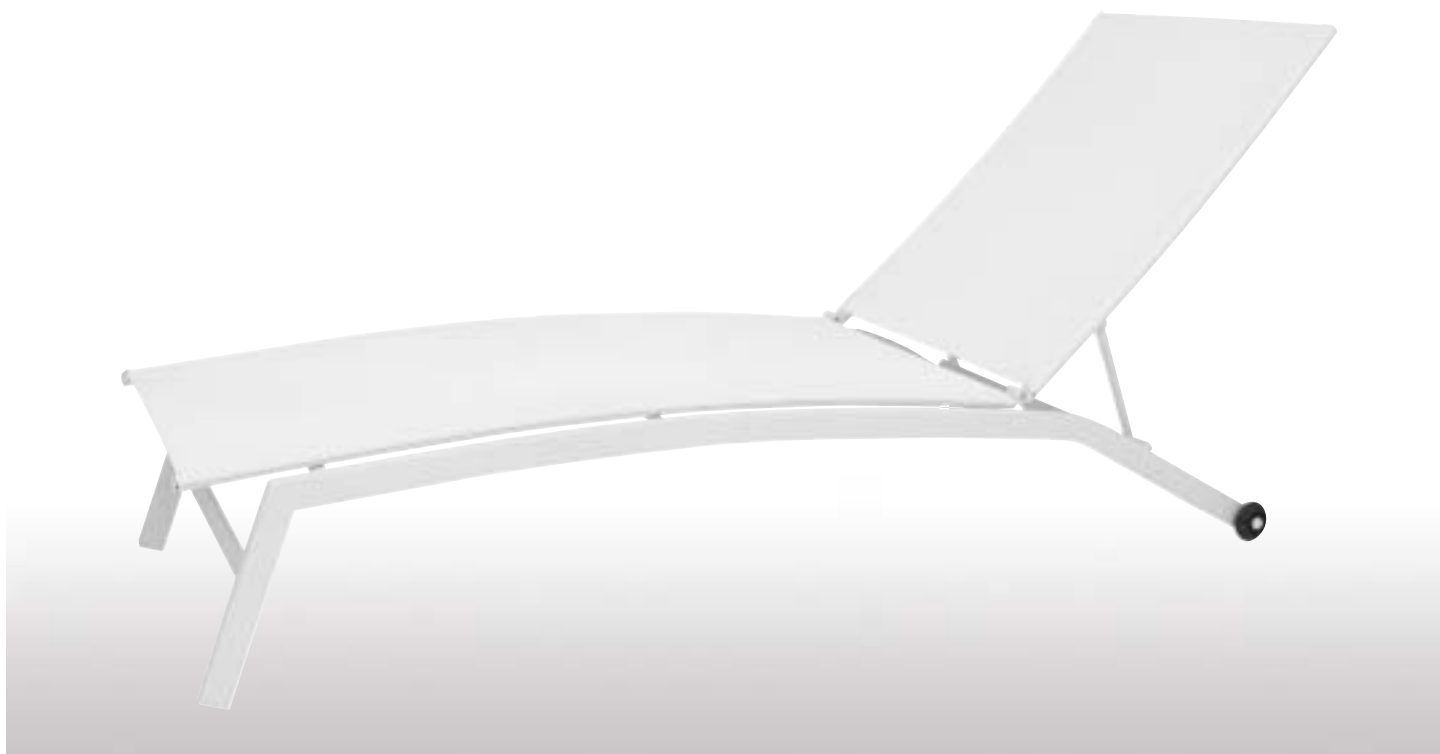

1546 - JY6F

Struttura in metallo verniciato rivestimento in textilene

Metal frame, powder coating, textylene covering
(L194 x P59 cm) KD

NEW



1671 - TE1

Struttura in polipropilene
Polypropylene frame
 (L45 x P45 x H45 cm)



1555 - T12

Struttura in alluminio verniciato
Aluminum frame, powder coating
 (L40 x P40 x H33 cm)



1557 - T13

Struttura in alluminio verniciato
Aluminum frame, powder coating
 (Ø45 x H33 cm)





020 - ALR12

Struttura in alluminio anodizzato e saldato, Ø 25 x 1,5 mm, seduta e schienale in filo di polietilene

Anodized aluminum, welded frame, tube Ø 25 x 1,5 mm, polyethylene thread covering

h A h h 
77 cm 41cm 44cm 44cm

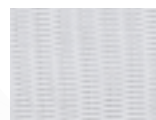

W



N



P



024 - ALR04

Struttura in alluminio anodizzato, filo in polietilene

Anodized aluminum frame, polyethylene thread covering

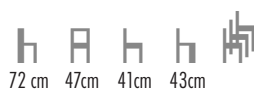

W

N



026 - ALR06

Struttura in alluminio anodizzato e saldato, Ø 25 x 1,5 mm, seduta e schienale in filo di polietilene

Anodized aluminum frame, tube Ø 25 x 1,5 mm, polyethylene thread covering

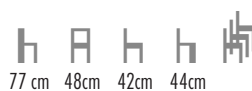

G

P



035 - ALW01
 Struttura in alluminio anodizzato,
 Ø 25 x 1,5 mm,
 doghe in legno di rovere
*Anodized aluminum frame,
 tube Ø 25 x 1,5 mm, oak bands*



037 - ALW04
 Struttura in alluminio anodizzato,
 doghe in legno di rovere
*Anodized aluminum frame,
 oak bands*

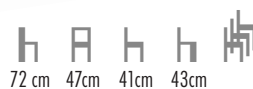

043 - ALW12
 Struttura in alluminio anodizzato e saldato, Ø 25 x 1,5 mm, doghe in legno di rovere
Anodized aluminum welded frame, tube Ø 25 x 1,5 mm, oak bands

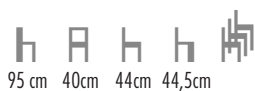

039 - ALW06
 Struttura in alluminio
 anodizzato e saldato,
 Ø 25 x 1,5 mm,
 doghe in legno di rovere
*Anodized aluminum welded frame,
 tube Ø 25 x 1,5 mm, oak bands*





038 - ALW05
 Struttura in alluminio anodizzato
 Ø 25 x 1,5 mm,
 doghe in legno di rovere
*Anodized aluminum frame,
 tube Ø 25 x 1,5 mm, oak bands*

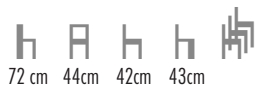

040 - ALW07
 Struttura in alluminio anodizzato
 Ø 25 x 1,5 mm,
 doghe in legno di rovere
*Anodized aluminum frame,
 tube Ø 25 x 1,5 mm, oak bands*

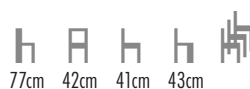

042 - ALW09
 Struttura in alluminio anodizzato
 Ø 28 x 1,8 mm,
 doghe in legno di rovere
*Anodized aluminum frame,
 tube Ø 28 x 1,8 mm, oak bands*



041 - ALW08
 Struttura in alluminio anodizzato
 Ø 28 x 1,8 mm,
 doghe in legno di rovere
*Anodized aluminum frame,
 tube Ø 28 x 1,8 mm, oak bands*





109 - MTW006A (60 x 60 cm)
110 - MTW006B (70 x 70 cm)
111 - MTW006C (80 x 80 cm)



106 - MTW001 (Ø 60 cm)
107 - MTW007A (Ø 70 cm)
108 - MTW007B (Ø 80 cm)



675 - MTW013A (60 x 60 cm)
676 - MTW013B (70 x 70 cm)
677 - MTW013C (80 x 80 cm)



678 - MTW011A (Ø 60 cm)
679 - MTW011B (Ø 70 cm)



001 - ALL01
 Struttura in alluminio anodizzato
 Ø 25 x 1,5 mm
*Anodized aluminum frame,
 tube Ø 25 x 1,5 mm*



004 - ALL04
 Struttura in alluminio anodizzato
Anodized aluminum frame

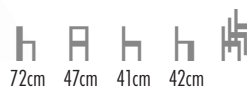

005 - ALL05
 Struttura in alluminio anodizzato
 Ø 25 x 1,5 mm
*Anodized aluminum frame,
 tube Ø 25 x 1,5 mm*

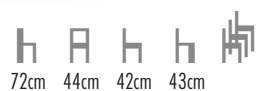

006 - ALL06
 Struttura in alluminio
 anodizzato e saldato
 Ø 25 x 1,5 mm
*Anodized aluminum
 welded frame,
 tube Ø 25 x 1,5 mm*





454 - ALL33
 Struttura in alluminio
 anodizzato e saldato Ø 25 x 1,5 mm
*Anodized aluminum
 welded frame, tube Ø 25 x 1,5 mm*

h A h h h
 85cm 40cm 40cm 44,5cm



007 - ALL07
 Struttura in alluminio
 anodizzato Ø 25 x 1,5 mm
*Anodized aluminum
 frame, tube Ø 25 x 1,5 mm*

h A h h h
 81cm 42cm 41cm 42cm



010 - ALL09
 Struttura in alluminio anodizzato
 Ø 28 x 1,8 mm
*Anodized aluminum frame,
 tube Ø 28 x 1,8 mm*

h A h h
 100cm 40cm 35cm 80cm



011 - ALL08
 Struttura in alluminio anodizzato
 Ø 28 x 1,8 mm
*Anodized aluminum frame,
 tube Ø 28 x 1,8 mm*

h A h h
 100cm 41cm 36cm 78cm



091 - MTA006 (60 x 60 cm)



089 - MTA002 (Ø 60 cm)

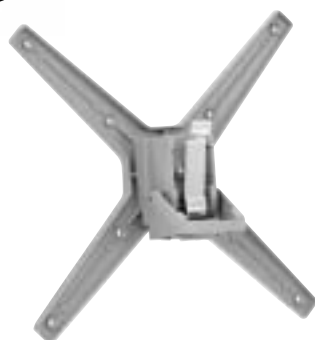

139 - M

Accessorio pieghevole
per tutti i tipi di tavoli
con tubo centrale

*Folding system
for all the tables
with central tube*



090 - MTA005 (60 x 60 cm)



088 - MTA001 (Ø 60 cm)



097 - MTA013A (60 x 60 cm)
098 - MTA013B (70 x 70 cm)
099 - MTA013C (80 x 80 cm)
717 - MTA013EK (120 x 80 cm)



100 - MTA011A (Ø 60 cm)
101 - MTA011B (Ø 70 cm)



093 - MTA007A (70 x 70 cm)
094 - MTA007B (80 x 80 cm)
943 - MTA014CK (120 x 80 cm)



092 - MTA003A (Ø 70 cm)
261 - MTA003B (Ø 80 cm)



096 - MTA010 (Ø 60 cm)



102 - MTA016K (Ø 60 cm)



095 - MTA009 (Ø 60 cm)



Esterno

Outdoor



Interno

Indoor



976 - ET53

Struttura in metallo verniciato

Metal frame, powder coating

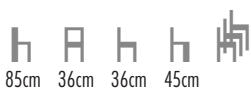



1084 - BT18

Struttura in metallo verniciato

Metal frame, powder coating

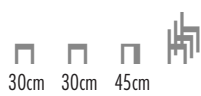



SEDIA CHAIR

978 - EM35W

Struttura in metallo verniciato,
seduta in legno

*Metal frame, powder coating,
wood seat*

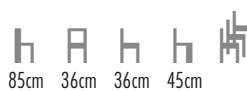

TAVOLO TABLE

1265 - 70W

(L70 x P70 x H74 cm)

972 - 36W

(L80 x P80 x H74 cm)

1418 - CT120

(L120 x P80 x H74 cm)

Struttura in metallo verniciato,

Metal frame, powder coating



NEW



1649 - 80WA

Struttura in metallo verniciato,
piano in legno d'olmo

*Metal frame, powder coating,
elmwood top*

(L80 x P80 x H75 cm) KD



955 - MC012

h A h h
98,5cm 30cm 30cm 76cm



1083 - MC012W

h A h h
98,5cm 30cm 30cm 76cm



977 - BT503

h h h h
30cm 30cm 76cm



1082 - BT503W

h h h h
30cm 30cm 76cm

Struttura in metallo verniciato / Metal frame, powder coating

Struttura in metallo verniciato, seduta in legno
Metal frame, powder coating, wood seat



1266 - CT60

Struttura in metallo verniciato

Metal frame, powder coating

(L60 x P60 x H105 cm)





1100 - M51

Struttura in metallo verniciato, effetto anticato
Metal frame powder coating, antique look



NEW



1575 - 36WA

Struttura in metallo verniciato,
effetto anticato

*Metal frame, powder coating,
antique look*

(L80 x P80 x H75 cm) KD



1295 - BT03

Struttura in metallo verniciato,
effetto anticato

*Metal frame, powder coating,
antique look*



30cm 30cm 76cm



W N R Y





1073 - MC012PZ

h A h h
98cm 30cm 30cm 76cm

Struttura in metallo zincato
e vernice trasparente
*Galvanized metal frame
and varnish*



1071 - M012Z

h A h h
30cm 30cm 76cm



971 - MC001B

h A h h
85cm 36cm 36cm 45cm



□ SEDIA CHAIR
969 - MC001T

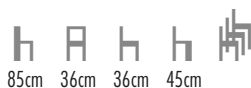

□ TAVOLO TABLE
1262 - 236D
(L80 x P80 x H76 cm) KD

Struttura in metallo verniciato
con vernice trasparente
Metal frame, powder coating with varnish

1066 - MC001TW
Struttura in metallo verniciato
con vernice trasparente, seduta in legno
*Metal frame, powder coating
with varnish, wood seat*

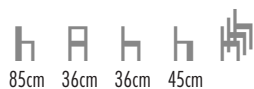



966 - MC012T



1060 - MC012PT



1264 - 010T

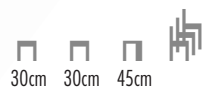

Struttura in metallo verniciato con vernice trasparente
Metal frame, powder coating with varnish



1068 - MC012PTW

Struttura in metallo verniciato con vernice trasparente, seduta in legno

Metal frame, powder coating with varnish, wood seat

h A h h
98cm 30cm 30cm 76cm



1267 - GT24

Struttura in metallo verniciato con vernice trasparente

Metalframe, powder coating with varnish

(L65 x P65 x H107 cm) KD



1067 - MC012TW

Struttura in metallo verniciato con vernice trasparente, seduta in legno

Metal frame, powder coating with varnish, wood seat

h h h h
30cm 30cm 76cm



1427 - 01N

Struttura in metallo verniciato, effetto canna di fucile

Metal frame, powder coating, gun look



85cm 36cm 36cm 45cm



1428 - 01NW

Struttura in metallo verniciato, effetto canna di fucile, seduta in legno

Metal frame, powder coating, gun look, wood seat



85cm 36cm 36cm 45cm



1496 - BT04

Struttura in metallo verniciato, effetto canna di fucile

Metal frame, powder coating, gun look



30cm 30cm 76cm



SEDIA CHAIR
968 - MC001D

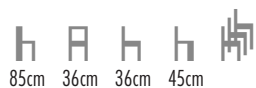

TAVOLO TABLE
956 - 36D
(L82 x P82 x H76 cm)

Struttura in metallo verniciato, effetto anticato
Metal frame, brush painting, antique look



CUSCINO PAD
1275 - PAD1

1077 - MC001DW
Struttura in metallo verniciato,
effetto anticato, seduta in legno
*Metal frame, brush painting,
antique look, wood seat*





1061 - MC012D



1062 - MC012DT



1263 - 009T

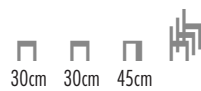

Struttura in metallo verniciato effetto anticato
Metal frame, brush painting, antique look



1079 - MC012DTW

Struttura in metallo verniciato effetto anticato, seduta in legno
Metal frame, brush painting, antique look, wood seat

h A h h
98cm 30cm 30cm 76cm



1268 - GT28

Struttura in metallo verniciato
effetto anticato

*Metal frame, brush painting,
antique look*

(L65 x P65 x H107 cm) KD



1078 - MC012DW

Struttura in metallo verniciato
effetto anticato, seduta in legno

*Metal frame, brush painting,
antique look, wood seat*

h h h h
30cm 30cm 76cm



1417 - BM37

Struttura in metallo verniciato,
effetto anticato, seduta in legno

*Metal frame powder coating,
antique look, wood seat*

□ □
33cm 65/78cm



1495 - BC02

Struttura in metallo verniciato,
effetto anticato, seduta in legno

*Metal frame powder coating,
antique look, wood seat*

□ □
30cm 63/81cm



1464 - 05A

Struttura in metallo verniciato

Metal frame, powder coating



72cm 36cm 36cm 44cm



W N R A V B G Y



1431 - MC001A

Struttura in metallo verniciato
con vernice trasparente

Metal frame, powder coating with varnish

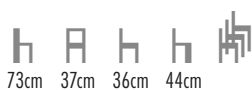

73cm 37cm 36cm 44cm



1432 - MC001AW

Struttura in metallo verniciato
con vernice trasparente, seduta in legno

*Metal frame, powder coating with varnish,
wood seat*



73cm 36cm 36cm 44cm

NEW



1661 - DA3

Struttura in metallo verniciato, rivestimento in velluto
Metal frame, powder covering, velvet covering

h A h h
84cm 44cm 44cm 47cm



1662 - DA4

Struttura in metallo cromato oro, rivestimento in velluto
Gold metal frame chromed, velvet covering

h A h h
84cm 44cm 44cm 47cm



AN



LG



M



B



V



P

NEW



1652 - J02

Struttura in metallo cromato oro, rivestimento in velluto

Gold metal frame chromed, velvet covering

78cm 46cm 42cm 46cm



LG



DG



LB



DB



V



R

NEW



1638 - DH2

Struttura in legno di faggio

Beeck wood frame



77cm 41cm 42cm 46cm

legno / wood



N

NA



1186 - HT35

Struttura in legno

Wood frame



89cm 50cm 54cm 45cm



1440 - HT38

Struttura in legno

Wood frame



113cm 41cm 36,5cm 76cm



W M



1188 - HT36

Struttura in legno, effetto anticato,
seduta in rattan

*Wood frame, antique look,
rattan seat*

h A h h
89cm 50cm 54cm 45cm



1321 - HT37

Struttura in legno, effetto anticato,
seduta in rattan

*Wood frame, antique look,
rattan seat*

h A h h
113cm 41cm 36,5cm 76cm



NAT

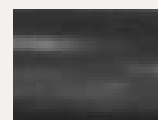

N



LM



NO



ST

NEW



NEW



□ SEDIA CHAIR
1673 - PA1

Struttura in legno
Rubber wood frame

89cm 44cm 43cm 44cm

legno / wood

NAT N/M

1674 - PA2

Struttura in legno
Rubber wood frame

89cm 44cm 43cm 44cm

legno / wood

NAT N/M

NEW



□ SEDIA CHAIR
1650 - PA3
Struttura in legno
Rubber wood frame

h A h h
85cm 43cm 42cm 44cm

legno / wood



1692 - PA4
Struttura in legno, seduta con cuscino
Rubber wood frame, seat with pad

h A h h
85cm 43cm 42cm 44cm

legno / wood



1042 - C25F

Struttura in legno,
seduta imbottita

*Wood frame,
seat with pad*

h A h h
84cm 43cm 50cm 46cm



1041 - C25

Struttura in legno,
seduta in legno

*Wood frame,
wood seat*

h A h h
84cm 43cm 50cm 46cm







1124 - M07

Struttura in metallo verniciato,
seduta e schienale in legno multistrato

*Metal frame, powder coating
seat and backrest in plywood*

h A h h
77cm 42cm 39cm 45cm

struttura / frame



W N



1036 - G02
 Struttura in legno,
 seduta in legno
*Wood frame,
 wood seat*

h A h h
 87cm 42cm 39cm 46cm

W R M G





1037 - G03
Struttura in legno,
seduta impagliata
*Wood frame,
natural straw seat*

h A h h
87cm 40cm 37cm 47cm

W R M G





1258 - G04L

Struttura in legno, seduta in legno / *Wood frame, wood seat*



h A h h
102cm 40cm 37cm 73cm



1038 - G04

Struttura in legno, seduta impagliata / *Wood frame, straw seat*



h A h h
102cm 40cm 37cm 73cm



1484 - AR7

Struttura in legno, seduta impagliata

Wood fram, straw seat



88cm 40cm 37cm 47cm





NEW



1585 - S37R

Struttura in legno di frassino,
seduta impagliata

*Ash wood frame,
natural straw seat*

h A h h
78cm 44cm 43cm 45cm

NAT M

NEW



1584 - S37

h A h h 
81cm 44cm 42cm 46cm



1582 - S37A

h A h h 
79cm 48cm 47cm 46cm



1583 - S847

h A h h 
110cm 41cm 37cm 75cm

Struttura in metallo verniciato, seduta impagliata,
schienale in multistrato

*Metal frame, powder coating, natural straw seat,
plywood backrest*



1014 - JK5

Struttura in metallo cromato,
seduta impagliata

Chromed metal frame, straw seat



84 cm 44cm 41cm 46cm



1015 - JK5B

Struttura in metallo cromato,
seduta impagliata

Chromed metal frame, straw seat



100 cm 41cm 39cm 75cm

NEW



1683 - ST23

Struttura in legno di faggio, schienale in polipropilene
Beech wood frame, polypropylene backrest

h A h h
 67cm 45cm 41cm 47cm



1684 - ST23A

Struttura in legno di faggio, schienale in polipropilene, poggiatesta in metallo
Beech wood frame, polypropylene backrest, metal footrest

h A h h
 99cm 45cm 37cm 76cm



1525 - D24

Struttura in polipropilene e metallo, gambe in legno di faggio

Polypropylene and metal frame, beech wood legs

h h h h
75cm 41cm 42cm 45cm

W N LG V B





1322 - Z87

Gambe in legno,
scocca in polipropilene

*Wood legs,
polypropylene shell*



84cm 43cm 40cm 45cm





NEW



1593 - XH2P

Struttura in legno di faggio, scocca in polipropilene, cuscino in tessuto

Beech wood frame, polypropylene frame, fabric pad

h A h h
80cm 39cm 40cm 45cm

W N R P T



1144 - 62F

Struttura in metallo e legno,
scocca in polipropilene, cuscino in tessuto

*Metal and wood frame,
polypropylene shell, fabric pad*

h A h h
82cm 48cm 50cm 46cm

1320 - W2C

Struttura in legno, scocca in policarbonato,
cuscino in tessuto

*Wood frame, polycarbonate shell,
fabric pad*

h A h h
81cm 49cm 58cm 46cm



1489 - YG99

Struttura in legno di faggio, rivestimento in ecopelle

Beeck wood frame, polyurethane covering

h A h h
75cm 42cm 42cm 44cm

legno / wood



N



NA

ecopelle / polyurethane



N



M

NEW



1587 - YG101

Struttura in legno multistrato di faggio,
rivestimento in ecopelle*Beech plywood frame, polyurethane covering*

h	A	h	h
77cm	46cm	42cm	44cm

ecopelle / polyurethane



V M

NEW



1586 - YG100

Struttura in legno multistrato di faggio,
rivestimento in tessuto

Beech plywood frame, fabric covering

h A h h
77cm 46cm 42cm 44cm



B



DG



LG



1492 - YG94

Struttura in legno di faggio, scocca in polipropilene,
cuscino in ecopelle

*Beeck wood frame, polypropylene shell,
polyurethane pad*

h A h h
76cm 42cm 42cm 44cm



1423 - YM2

Struttura in legno di faggio, rivestimento in ecopelle
Beech wood frame, polyurethane covering

h A h h
83cm 45cm 43cm 43cm

struttura / frame



ecopelle / PLI



1422 - YM1

Struttura in legno di faggio, rivestimento in ecopelle
Beech wood frame, polyurethane covering

h A h h
76cm 46cm 43cm 44,5cm

struttura / frame



ecopelle / PLI



NEW



1626 - EV10

Struttura in legno di faggio con seduta girevole, scocca in polipropilene, cuscino in ecopelle

Beech wood frame with shell function mechanism, polyurethane pad

struttura / frame

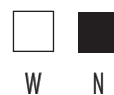



1682 - ST77

Gambe in legno di faggio, scocca in polipropilene,
cuscino in ecopelle

*Beech wood legs, polypropylene shell,
polyurethane pad*

h A h h
78cm 43cm 39cm 47cm

□ ■
W T



1438 - C50W

Struttura in metallo e legno, seduta e schienale in tessuto o ecopelle
Metal and wood frame, seat and backrest in fabric or polyurethane

1439 - C50P

Struttura in metallo verniciato, seduta e schienale in tessuto o ecopelle
Metal frame, powder coating, seat and backrest in fabric or polyurethane

h A h h
 81cm 44cm 44cm 48cm

ecopelle / polyurethane

 W N G DM

tessuto / fabric

 G DG DB



1335 - W58

Struttura in metallo e legno,
rivestimento in tessuto o ecopelle

*Metal and wood frame,
polyurethane or fabric covering*

h A h h
85cm 57cm 51cm 47cm

ecopelle / polyurethane

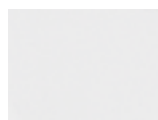

W



N

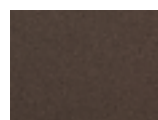

M

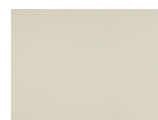

BE



G





1335 - W58

Struttura in metallo e legno,
rivestimento in tessuto o ecopelle

*Metal and wood frame,
polyurethane or fabric covering*



85cm 57cm 51cm 47cm

tessuto / fabric

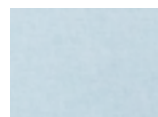





1334 - B91

Struttura in legno multistrato e legno massello, rivestimento in ecopelle

Plywood frame and solid rubber wood, polyurethane covering

79cm 51,5cm 51,5cm 46cm

ecopelle / polyurethane



A

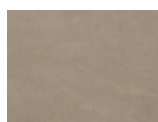

B

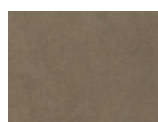

C

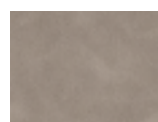

D

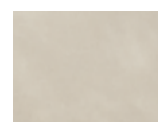

E





1524 - D22

Struttura in legno e metallo,
rivestimento in tessuto

*Wood and metal frame,
shell with fabric covering*

h A h h
83cm 45cm 42cm 46cm

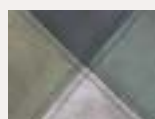

PK18



PK17



1523 - D23

Struttura in legno e metallo,
rivestimento in tessuto

*Wood and metal frame,
shell with fabric covering*

h A h h
80cm 44cm 40cm 46cm



PK18

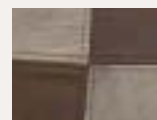

PK17

NEW





1185 - PW07

Struttura in legno e metallo,
rivestimento in tessuto

Wood and metal frame,
shell with fabric covering





 81cm 55cm 60cm 46cm

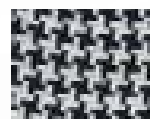

N

R

M

V

G

A

B

PAT

PAD





1150 - 72B

Struttura in legno,
rivestimento in tessuto

Wood frame, fabric shell

h A h h
81cm 49cm 58cm 46cm





1193 - PW72

Struttura in legno, scocca in polipropilene, seduta in ecopelle
Wood frame, polypropylene shell, polyurethane pad





 82cm 48cm 50cm 46cm









 W N R A G V Y



1148 - 72K

Struttura in metallo e legno,
scocca in polipropilene, cuscino in ecopelle

*Metal and wood frame,
polypropylene shell, polyurethane pad*

h A h h
82cm 48cm 50cm 45cm

□ ■ ■ ■
W N R G





1057 - PW022
 Struttura in metallo e legno,
 scocca in polipropilene
*Wood and metal frame,
 polypropylene shell*

h A h h
 83cm 56cm 40cm 46cm



1092 - FL08W
 Struttura in metallo e legno,
 scocca in polipropilene
*Metal and wood frame,
 polypropylene shell*

h A h h
 85,5cm 55cm 45cm 45cm





1143 - M2

Struttura in metallo e legno,
seduta in polipropilene

*Metal and wood frame,
polypropylene seat*

□ □ □
47cm 35cm 47cm





1103 - NET08

Struttura in metallo e legno, scocca in polipropilene

Woody and metal frame, polypropylene shell



80cm 42cm 40cm 45cm



W N G



1419 - ITP3

h A h h
76cm 47cm 50cm 48cm



1436 - ITP4

h A h h
107cm 44cm 45cm 79cm

Struttura in legno, rivestimento in ecopelle
Wood frame, polyurethane covering

legno / wood



ecopelle / polyurethane





926 - JY05

Struttura in legno, rivestimento in ecopelle

Wood frame, polyurethane covering

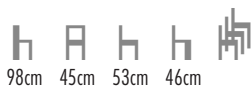

1035 - D060

Struttura in legno, rivestimento in ecopelle

Wood frame, polyurethane covering



924 - JY51

Struttura in legno, rivestimento in ecopelle

Wood frame, polyurethane covering

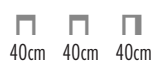



925 - JY08

Struttura in legno,
rivestimento in ecopelle

*Wood frame,
polyurethane covering*



101cm 41cm 51cm 77cm



W N M P



917 - JY11

Struttura in legno,
rivestimento in ecopelle

*Wood frame,
polyurethane covering*



75cm 40cm 40cm 75cm



W N M P



1451 - 7BD

Struttura in metallo, rivestimento in ecopelle

Metal frame, polyurethane covering



87cm 42cm 41cm 47cm



1456 - 30D

Struttura in metallo, rivestimento in ecopelle

Metal frame, polyurethane covering

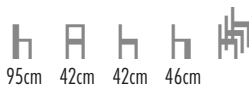

95cm 42cm 42cm 46cm

NEW



ecopelle / polyurethane



W



N

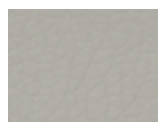

G



T

tessuto / fabric



LG



DG



BE



LM

Struttura in metallo verniciato,
rivestimento in tessuto o ecopelle
*Metal frame powder coating,
fabric or polyurethane covering*

NEW



1616 - TOP9

h A h h
74cm 58cm 52cm 40cm



1617 - TOP10

h A h h
100cm 40cm 43cm 76cm



1615 - TOP8

h A h h
83cm 41cm 46cm 47cm



1528 - T07

Struttura in metallo verniciato, rivestimento in ecopelle / *Metal frame powder coating, polyurethane covering*

h A h h
82cm 45cm 45cm 48cm



NEW



1693 - F450

Struttura in metallo verniciato, rivestimento in tessuto
Metal frame powder coating, fabric covering

h A h h
 81cm 43cm 46cm 46cm

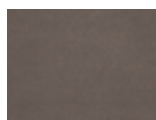

M

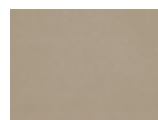

T



VI

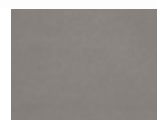

G



V

NEW



1601 - 82P

Struttura in metallo verniciato, rivestimento in ecopelle
Metal frame powder coating, PLI covering

h A h h
76cm 43cm 42cm 47cm



1602 - 82C

Struttura in metallo cromato, rivestimento in ecopelle
Chromed frame powder coating, PLI covering

h A h h
76cm 43cm 42cm 47cm



821 - RF49C

Struttura in metallo cromato,
rivestimento in ecopelle

*Chromed metal frame,
PVC covering*



90cm 41,5cm 41,5cm 46cm



W N M



825 - RF49P

Struttura in metallo verniciato,
rivestimento in ecopelle

*Metal frame, powder
coating, PVC covering*



90cm 41,5cm 41,5cm 46cm







1105 - RF91

Struttura in metallo verniciato, rivestimento in ecopelle

Metal frame, powder coating, PVC covering

h A h h
90cm 41cm 41cm 46cm

W N R V



1020 - SS95
 Struttura in metallo,
 rivestimento in ecopelle
Metal frame
polyurethane covering

h A h h
 80cm 61cm 52cm 47cm



NEW



1613 - TOP6

Struttura in metallo, rivestimento in pelle rigenerata
Metal frame, recycling leather covering

h A h h
76cm 44cm 43cm 45cm

NEW



1614 - TOP7

Struttura in metallo verniciato, rivestimento esterno in ecopelle, interno in tessuto

Metal frame, powder coating, outside polyurethane covering, inside fabric covering



76cm 43cm 42cm 47cm



1485 - F50

Struttura in metallo, rivestimento in ecopelle
Metal frame, polyurethane covering



99cm 45cm 39cm 47cm





1482 - F442

Struttura in metallo, rivestimento in ecopelle / *Metal frame, polyurethane covering*

h A h h
80cm 43cm 42cm 47cm





949 - F400

Struttura in metallo,
rivestimento in ecopelle

Metal frame, polyurethane covering



87cm 43cm 40cm 47,5cm





948 - F503

Struttura in metallo,
rivestimento in ecopelle

Metal frame, polyurethane covering



96cm 43cm 40cm 47cm





824 - RF97

Struttura in metallo,
rivestimento in ecopelle

*Metal frame,
PVC covering*



96cm 45cm 45cm 46cm



W N R A V M G





837 - C4135

Struttura in metallo cromato,
seduta e schienale in ecopelle

*Chromed metal frame,
PVC seat and backrest*



83,5cm 40,5cm 41cm 46cm





608 - C2406

Struttura in metallo cromato,
seduta e schienale in ecopelle

*Chromed metal frame,
PVC seat and backrest*



79cm 51cm 56cm 45cm



W N





593 - C2842

Struttura in metallo cromato,
seduta e schienale in ecopelle

*Chromed metal frame,
polyurethane seat and back*



85cm 45cm 53cm 46cm





1329 - CQ04

Struttura in metallo cromato,
seduta e schienale in ecopelle
*Chromed metal frame,
polyurethane seat and backrest*



81cm 44cm 43cm 47cm



N R



1330 - CQ03

Struttura in metallo cromato,
seduta e schienale in ecopelle
*Chromed metal frame,
polyurethane seat and backrest*



110cm 39cm 37cm 77cm



N R





1331 - CQ02

Struttura in metallo cromato, seduta e schienale in ecopelle
Chromed metal frame, polyurethane seat and backrest



h A h h
 83cm 101cm 44cm 45cm

■ ■
 N R



1332 - CQ13

Struttura in metallo e legno, seduta e schienale in ecopelle
Metal and wood frame, polyurethane seat and backrest



h A h h
 96cm 126cm 45cm 45cm

■ ■
 N R



1259 - M0120C

Struttura in policarbonato

Polycarbonate frame



95cm 41cm 45cm 46cm



T W N



888 - ISA
Struttura in policarbonato
Polycarbonate frame

h A h h 
85cm 41,5cm 43cm 47cm



889 - PC492
Struttura in policarbonato
Polycarbonate frame

h A h h 
85cm 37cm 38,5cm 48cm

NEW



1589 - YG103

Struttura in metallo cromato, scocca in polipropilene,
cuscino in ecopelle

*Chromed metal frame, polypropylene shell,
polyurethane pad*



76cm 42cm 42cm 45cm

scocca / shell



W N G



1486 - YG91

Struttura in metallo cromato, scocca in polipropilene,
cuscino in ecopelle

*Chromed metal frame, polypropylene shell,
polyurethane pad*



77cm 42cm 42cm 45cm

scocca / shell



W N G

NEW



1625 - EV24

Struttura in metallo verniciato, scocca in polipropilene
Metal frame, powder coating, polypropylene shell

h A h h
 80cm 43cm 39cm 46cm

struttura / frame



NEW



1623 - EV03

Struttura in metallo verniciato, scocca in polipropilene

Metal frame, powder coating, polypropylene shell



82cm 43cm 39cm 45cm

struttura / frame



W N G V



1686 - EVC03

Struttura in metallo cromato, scocca in polipropilene

Chromed metal frame, powder coating, polypropylene shell



82cm 43cm 39cm 45cm



W N G V

NEW



1622 - EV07

Struttura in metallo verniciato, scocca in polipropilene

Metal frame, powder coating, polypropylene shell



83cm 44cm 40cm 45cm



struttura / frame



W N G V



1687 - EVC07

Struttura in metallo cromato, scocca in polipropilene

Chromed metal frame, powder coating, polypropylene shell



83cm 44cm 40cm 45cm



W N G V



1624 - EV012

Struttura in metallo verniciato, scocca in polipropilene
Metal frame, powder coating, polypropylene shell

h A h h
 81cm 44cm 40cm 45cm

struttura / frame



1685 - EVC12

Struttura in metallo cromato, scocca in polipropilene
Chromed metal frame, powder coating, polypropylene shell

h A h h
 81cm 44cm 40cm 45cm





893 - CT390

Struttura in metallo cromato,
scocca in polipropilene

*Chromed metal frame,
polypropylene shell*



81,5cm 42cm 40cm 44,5cm





074 - CT123

Struttura in metallo cromato,
scocca in polipropilene

*Chromed metal frame,
polypropylene shell*



82cm 39cm 42,5cm 46cm



W N R B G



922 - CT20

Struttura in metallo cromato,
scocca in polipropilene

*Chromed metal frame,
polypropylene shell*



86cm 38cm 39cm 45,5cm





626 - KG1C

Struttura in metallo cromato,
seduta e schienale in polipropilene

*Chromed metal frame,
polypropylene seat and backrest*



79cm 37cm 43cm 45cm



W N R V



219 - 1153-1

Struttura in metallo cromato,
seduta e schienale in polipropilene

*Chromed metal frame,
polypropylene seat and backrest*



80cm 39cm 39cm 45cm





697 - Y30S

Struttura in metallo verniciato,
seduta e schienale in polipropilene

*Metal frame, powder coating,
polypropylene seat and backrest*



83cm 38cm 40cm 40,5cm





616 - PP8165

Struttura in metallo cromato, scocca in polipropilene

Chromed metal frame, polypropylene shell



81cm 54cm 55cm 43cm



R V



590 - K18C

Struttura in metallo cromato,
seduta e schienale in polipropilene

*Chromed metal frame,
polypropylene seat and backrest*



81cm 38cm 39cm 46cm



W N R V



710 - KC07

Struttura in metallo verniciato,
seduta e schienale in polipropilene

*Metal frame, power coating,
polypropylene seat and backrest*

h A h h
76cm 38cm 38cm 44cm

□ ■ ■
W N R



343 - AB47T

Struttura in metallo cromato Ø 22 mm,
scocca in legno multistrato

*Chromed metal frame Ø 22 mm,
plywood shell*



85cm 41cm 41cm 45,5cm



NA WE W



1101 - BS001MC

Struttura in metallo cromato,
scocca in legno multistrato

*Chromed metal frame,
plywood shell*



87cm 40,5cm 41cm 46,5cm



NA WE W N



263 - AB027T

Struttura in metallo cromato Ø 22mm,
scocca in legno multistrato

*Chromed metal frame Ø 22 mm,
plywood shell*



86cm 41cm 42cm 45,3cm



NA WE W



670 - PE001T

Struttura in metallo cromato Ø 22 mm,
scocca in legno multistrato

*Chromed metal frame Ø 22 mm,
plywood shell*



86cm 44cm 43cm 46cm



NA WE



871 - MC4C

Struttura in metallo cromato e legno, scocca in legno multistrato naturale, cuscino in ecopelle

Wood and chromed metal frame, plywood shell, with polyurethane pad



86cm 44cm 42cm 45cm

828 - MA4C

Struttura in metallo cromato e legno, scocca legno multistrato naturale

Wood and chromed metal frame, plywood shell



86cm 44cm 42cm 46cm



267 - AB001T

Struttura in metallo cromato Ø 22 mm,
scocca in legno multistrato

*Chromed metal frame Ø 22 mm,
plywood shell*



86cm 44cm 42cm 46cm



NA WE



083 - AR100

Struttura in metallo verniciato,
seduta in polipropilene

*Metal frame, powder coating,
polypropylene seat*



88cm 40cm 46cm 46cm



084 - AR38

Struttura in metallo verniciato,
seduta in polipropilene

*Metal frame, powder coating,
polypropylene seat*



87cm 40cm 46cm 46cm

NEW



1504 - S8C

Struttura in metallo cromato, rivestimento in tessuto o in ecopelle

Chromed metal frame, fabric or polyurethane covering

(L59 x P53 x H76 cm)



1520 - S8V

Struttura in metallo verniciato, rivestimento in tessuto o in ecopelle

Metal frame, powder coating, fabric or polyurethane covering

(L59 x P53 x H76 cm)



ecopelle / polyurethane



W

N

G

T

tessuto / fabric



N

LG

B

V



Struttura in metallo verniciato, rivestimento in tessuto
Metal frame, powder coating, fabric covering



1604 - 06S
(L123 x P50 x H77 cm)

NEW



1605 - 06P
(L64 x P50 x H77 cm)



A



B



V



Y



LR



LG



NEW



1603 - 06T
(L63 x P47 x H37 cm)



A



B



V



Y



LR



LG





DIVANO *SOFA*
1122 - C12S
(L108 x P58 x H74 cm)

POLTRONA *ARMCHAIR*
1121 - C12P
(L60 x P58 x H74 cm)

Struttura in metallo verniciato, cuscini in ecopelle
Metal frame, powder coating, polyurethane cushions







□ DIVANO SOFA
1192 - S02
(L170 x P81 x H82 cm)

Struttura in polipropilene e legno,
cuscini in tessuto

*Polypropylene and wood frame,
fabric cushions*



□ POLTRONA ARMCHAIR
1191 - S01
(L91 x P81 x H82 cm)





POLTRONA *ARMCHAIR*
1657 - FU2P
(64 x P54 x H99 cm)

POUF *OTTOMAN*
1656 - FU1P
(L51 x P42 x H37 cm)

Struttura in metallo, rivestimento in tessuto o in ecopelle
Metal frame, fabric or polyurethane covering



ecopelle / *polyurethane*



N

M

BE

LG

tessuto / *fabric*



N

G

B

P

VI

R

NEW



1664 - TF21

Struttura in metallo verniciato, rivestimento in ecopelle

Metal frame, powder coating, polyurethane covering

h A h h
90cm 45cm 45cm 43cm



PA

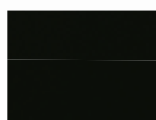

N



R

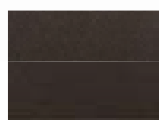

M



G



T



P



SE



625 - C2816

Struttura in metallo, rivestimento in ecopelle,
disponibile con ruote o piedini in plastica

*Metal frame, polyurethane covering,
available with wheel or plastic feet*

h h A h
79cm 63cm 56cm 48cm



W



N



R



A



V



B



G



DG



BE



836 - C4041

Struttura in metallo, rivestimento in ecopelle
Metal frame, polyurethane covering

h A h h
91cm 55cm 50cm 48cm



W



N



R



A



V



B



G



BE

NEW



PA



N



M



T



BE

1633 - GU34

Struttura in metallo verniciato,
rivestimento in ecopelle

*Metal frame, powder coating,
polyurethane covering*

(L61 x P53 x H71 cm)

NEW



1660 -DA2

Struttura in metallo verniciato, slitte in legno, rivestimento in tessuto

Metal frame, powder coating, solid wood sledge, fabric covering

(L60 x P47 x H101 cm)

NEW



1659 - DA1
Struttura in metallo verniciato,
rivestimento in tessuto
*Metal frame, powder coating,
fabric or polyurethane covering*
(L60 x P47 x H104 cm)

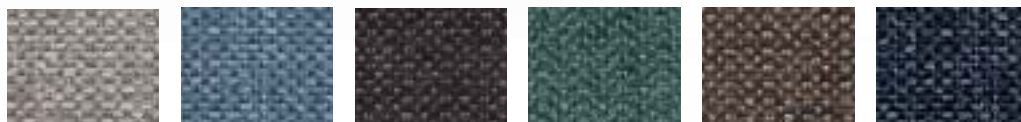

G

LB

N

V

B

DB



NEW



1612 - TOP5

Struttura cromata girevole in metallo, rivestimento in ecopelle
Chromed metal swivel frame, polyurethane covering

h A h h
80cm 48cm 45cm 46cm

ecopelle / polyurethane



G

T



PA

M



1240 - V61
(L64 x P59 x H74 cm)

Struttura in legno,
rivestimento in ecopelle
*Wood frame,
polyurethane covering*



1241 - V61D
(L113 x P59 x H74 cm)



432 - X17P PATENT

Struttura in acciaio inox,
rivestimento anteriore in pelle,
posteriore in ecopelle

*Stainless steel frame,
leather front covering
polyurethane back covering*

620 - X17PS PATENT

Struttura in acciaio inox,
rivestimento in ecopelle

*Stainless steel frame,
polyurethane covering*

(L76 x P70 x H68 cm)



W N



475 - X17D2 PATENT

Struttura in acciaio inox, rivestimento anteriore in pelle, posteriore in ecopelle

Stainless steel frame, leather front covering, polyurethane back covering

619 - X17D2S PATENT

Struttura in acciaio inox, rivestimento in ecopelle

Stainless steel frame, polyurethane covering

(L130 x P70 x H68 cm)





431 - X17D3 PATENT

Struttura in acciaio inox, rivestimento anteriore in pelle, posteriore in ecopelle

Stainless steel frame, leather front covering, polyurethane back covering

618 - X17D3S PATENT

Struttura in acciaio inox, rivestimento in ecopelle

Stainless steel frame, polyurethane covering

(L180 x P70 x H68 cm)

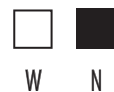



ANGOLO *CORNER*
1025 - 69C
(L71 x P71 x H70 cm)

POLTRONA S/B *CHAIR*
1026 - 69M
(L71 x P71 x H70 cm)

POUF *POUF*
1027 - 69FT
(L71 x P71 x H43 cm)

Struttura in acciaio inox,
rivestimento in ecopelle

*Stainless steel frame,
polyurethane covering*





1509 -D062

Struttura in legno, rivestimento in tessuto

Wood frame, fabric covering



(L59 x P53 x H84 cm)

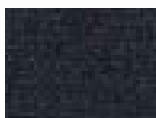

N



BE

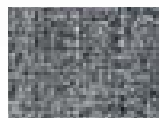

LG



DG



B



M



1510 -D080

Struttura in legno, rivestimento in tessuto

Wood frame, fabric covering

(L115 x P53 x H84 cm)



N



BE



LG



DG



B



M



1340 - FE1

Struttura in legno,
rivestimento in tessuto
o in pelle rigenerata

*Wood frame,
fabric or bonded
leather covering*

h A h h
80cm 70cm 78cm 44cm



tessuto / fabric



M



CA

pelle rigenerata / bonded leather

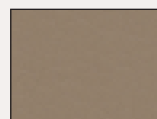

T



N



M

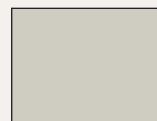

C



NEW



1618 - TOP11
Struttura in legno,
rivestimento in tessuto
*Wood frame,
fabric or bonded*
(L65 x P55 x H85 cm)

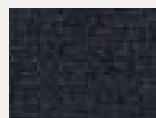

N



BE

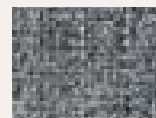

LG



DG



M



1000 - JY06

Rivestimento in ecopelle

Polyurethane back covering

(L74 x P70 x H74 cm)



W

N

M

NEW



1643 - 4BC2

Struttura in plastica,
base in alluminio lucido,
seduta e schienale in tessuto,
7 possibilità di regolazione

*Plastic frame, polished aluminum base,
fabric seat and backrest,
7 positions of adjustment*

h A h h
109/98cm 66cm 64cm 58/47cm

NEW



1642 - 4B2

Struttura in plastica,
base in alluminio verniciata,
seduta e schienale in tessuto,
7 possibilità di regolazione

*Plastic frame, aluminum base,
powder coating, fabric seat and backrest,
7 positions of adjustment*

h A h h
109/98cm 66cm 64cm 58/47cm

tessuto / fabric



W

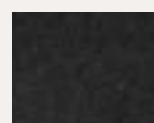

N

struttura / frame



W



N



762 - LS31

Struttura in fusione d'alluminio,
scocca in textilene

*Aluminum frame,
textylene shell*

h A h h
95/88cm 59cm 50cm 51/44cm



W N



763 - LS30

Struttura in fusione d'alluminio,
scocca in textilene

*Aluminum frame,
textylene shell*

 110/103cm 59cm 50cm 51/44cm



 W N



764 - LS11

Struttura in fusione d'alluminio,
scocca in ecopelle

*Aluminum frame,
polyurethane shell*

95/88cm 59cm 50cm 51/44cm

 
W N



765 - LS10

Struttura in fusione d'alluminio,
scocca in ecopelle

*Aluminum frame,
polyurethane shell*



110/103cm 59cm 50cm 51/44cm



W



N





1237 - HM2

h A h h
111/105cm 58cm 59cm 50/44cm

1238 - MM2

h A h h
95/89cm 58cm 59cm 50/44cm

1239 - VM2

h A h h
94cm 57cm 56cm 46cm



Struttura in alluminio e acciaio cromato, rivestimento in textilene / Aluminum and chromed iron frame, textilene covering



1234 - HL1

h A h h
111/105cm 58cm 59cm 50/44cm

1235 - ML1

h A h h
95/89cm 58cm 59cm 50/44cm

1236 - VL1

h A h h
94cm 57cm 56cm 46cm



Struttura in alluminio e acciaio cromato, rivestimento in ecopelle / Aluminum and chromed iron frame, polyurethane covering



529 - W81

Struttura in nylon con fibra di vetro,
base in alluminio cromata, seduta in tessuto,
6 possibilità di regolazione

*Nylon frame with fiberglass,
chromed aluminum base,
fabric seat, textylene backrest,
6 positions of adjustment*



h A h h
98,5/90cm 51,5cm 50cm 51,5/43cm

□ ■ ■ ■
W N R B



671 - W03

Base cromata, rivestimento in
textilene ed ecopelle

*Chromed base, polyurethane and
mesh fabric upholstery*

h A h h
115/107cm 61cm 63cm 52/45cm



606 - W94

Struttura in nylon con fibra di vetro,
base cromata, seduta in tessuto,
8 possibilità di regolazione

*Nylon frame with fiberglass, chromed base,
fabric seat, textylene backrest,
8 positions of adjustment*

h A h h
122/113cm 51,5cm 50cm 52/43cm

NEW



1628 - EV11

Struttura in metallo verniciato, scocca in polipropilene
Metal frame, powder coating, polypropylene shell

h A h h
 86/93cm 44cm 37cm 47/54cm

struttura / frame



W

N

scocca / shell



W

N

G



1629 - EV13

Struttura in metallo cromato, scocca in polipropilene
Chromed metal frame, polypropylene shell

h A h h
 86/93cm 44cm 37cm 47/54cm



1491 - YG98

Struttura in metallo cromato, scocca in polipropilene, cuscino in ecopelle
Chromed metal frame, polypropylene shell, polyurethane pad

h A h h
 76/81cm 42cm 42cm 45/50cm

scocca / shell



1490 - YG97

Struttura in metallo verniciato, scocca in polipropilene, cuscino in ecopelle
Metal frame, powder coating, polypropylene shell, polyurethane pad

h A h h
 76/81cm 42cm 42cm 45/50cm



1126 - K03

Struttura in metallo cromato, scocca in polipropilene, cuscino in ecopelle
 Chromed metal frame, polypropylene shell, polyurethane pad

h h h h
 90/78cm 39cm 43cm 54/42cm

W N R Y G V



669 - WX910

Struttura in metallo cromato,
seduta e schienale in ecopelle

*Chromed metal frame,
PVC seat and back*





 92/84cm 49cm 57cm 50/42cm



W N R

NEW



1651 - J01G

Struttura in metallo cromato oro, rivestimento in velluto

Chromed gold metal frame, velved fabric covering

h A h h
97cm 46cm 42cm 66cm



LG



DG



LB



DB



V



R



1007 - F600

Struttura in metallo cromato, rivestimento in ecopelle

Chromed metal frame, polyurethane covering



100cm 41cm 37cm 76cm





1497 - K31

Struttura in legno e metallo,
seduta in polipropilene, cuscino in ecopelle

*Wood and metal frame,
polypropylene seat, polyurethane pad*

h A h h
99cm 39cm 33cm 76cm





1303 - PW026

Struttura in legno e metallo,
scocca in polipropilene

*Wood and metal frame,
polypropylene shell*

h A h h
105cm 44cm 40cm 69cm

□ ■ ▒
W N G

NEW



1655 - FU95

Struttura in legno, seduta in polipropilene,
cuscino in ecopelle

*Wood frame, polypropylene seat,
polyurethane pad*

h A h h
89cm 39cm 35cm 72cm

□ ■ ▒
W N G



1500 - K32

Struttura in legno, seduta in polipropilene,
cuscino in ecopelle

*Wood frame, polypropylene seat,
polyurethane pad*





 85cm 40cm 40cm 76cm



 W N G

NEW



1627 - EV36

Struttura in legno di quercia,
scocca in polipropilene

Oak wood frame, polypropylene shell

h A h h
102cm 39cm 34cm 77cm



NEW



1639 - EV37

Struttura in legno di quercia,
scocca in polipropilene, seduta in ecopelle

*Oak wood frame, polypropylene shell,
polyurethane pad*

h A h h
110cm 46cm 41cm 72cm





646 - AB047BB
 Struttura in metallo cromato,
 scocca in legno multistrato
*Metal steel frame,
 plywood shell*



h A h h h
 102cm 39,5cm 39,5cm 75,5cm

NA WE W



442 - BB010

Struttura in metallo cromato,
scocca in legno multistrato

*Chromed metal frame,
plywood shell*



102cm 39,5cm 39,5cm 75,5cm





932 - K38

Struttura in metallo cromato,
scocca in polipropilene

*Chromed metal frame,
polypropylene shell*



100cm 39cm 34cm 77cm





443 - CT123-1

Struttura in metallo cromato,
scocca in polipropilene

*Chromed metal frame,
polypropylene shell*



112cm 39cm 42,5cm 76cm



W N R



815 - C77

Struttura in metallo cromato,
seduta schienale in polipropilene

*Chromed metal frame,
polypropylene seat and backrest*



79cm 37cm 43cm 74,5cm



W N R V



221 - B1201

Struttura in metallo cromato,
seduta e schienale in polipropilene

*Chromed metal frame,
polypropylene seat and backrest*

h A h h
111cm 39cm 39cm 75cm





838 - C4063

Struttura in metallo cromato,
seduta e schienale in ecopelle

*Chromed metal frame,
PVC seat and backrest*



129cm 49cm 56cm 75cm



W N R

NEW

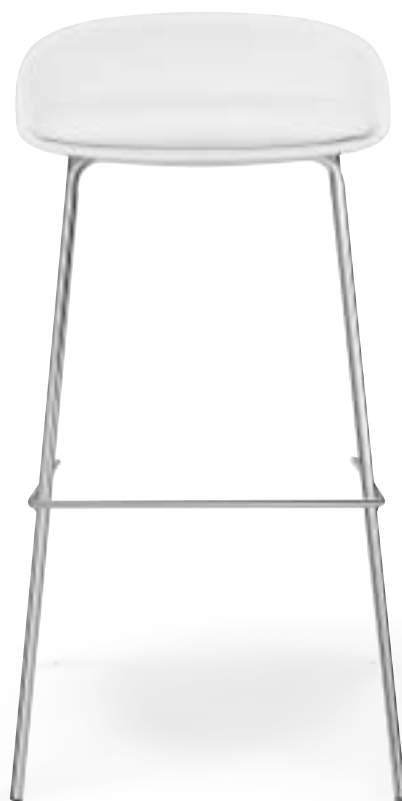

1630 - EV23

Struttura in metallo cromato, seduta in polipropilene, cuscino in ecopelle

Chromed metal frame, polypropylene seat, polyurethane pad



h A h h
87cm 39cm 39cm 77cm





513 - A661A

Struttura in metallo cromato,
seduta in ecopelle

*Chromed metal frame,
polyurethane seat*

□ □
75,5cm 38,5cm

□ ■
W N



□ SGABELLO *BAR STOOL*
223 - B010

Struttura in metallo cromato,
seduta girevole in ecopelle

*Chromed metal frame,
swivel seat, polyurethane covering*

□ □
33cm 76cm

□ ■ ■
W N R



245 - B030

Struttura in metallo cromato,
seduta girevole in ecopelle

*Chromed metal frame,
swivel seat, polyurethane covering
seat and backrest*



107,5cm 38cm 76cm





512 - A174

Struttura in metallo cromato,
seduta in ecopelle

*Chromed metal frame,
polyurethane seat*



95/73cm 40cm 38cm 84/62cm





997 - K3001

Struttura in metallo cromato,
scocca in polipropilene,
cuscino in ecopelle

*Chromed metal frame,
polypropylene shell,
polyurethane pad*





 107/86cm 41cm 37cm 81/60cm







 W N R A V G



1113 - BY035

Struttura in metallo cromato,
seduta in ecopelle

Chromed metal frame, PVC seat

   
108/86cm 37cm 32cm 80/58cm

  
W N R

NEW



1566 - V12
 Struttura in metallo cromato,
 seduta in textilene
*Chromed metal frame,
 textylene seat*

 114/93cm 38cm 35cm 82/61cm

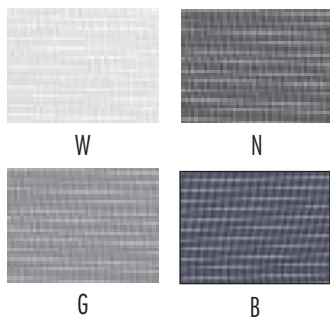



933 - K08

Struttura in acciaio cromato,
scocca in polipropilene

*Chromed steel frame,
polypropylene shell*



104/83cm 39cm 34cm 81/60cm





934 - K00

Struttura in metallo cromato, scocca in polipropilene

Chromed metal base, polypropylene shell



105/83cm 41cm 38cm 81/59cm





1031 - 795

Struttura in metallo cromato,
scocca in polipropilene

*Chromed metal frame,
polypropylene shell*

h A h h
94/73 cm 39cm 34cm 78/57cm

□ ■
W N



595 - T010

Struttura in metallo cromato,
seduta in ABS

*Chromed metal frame,
ABS seat*

h A h h
93/73cm 36cm 40cm 79/59cm



W N



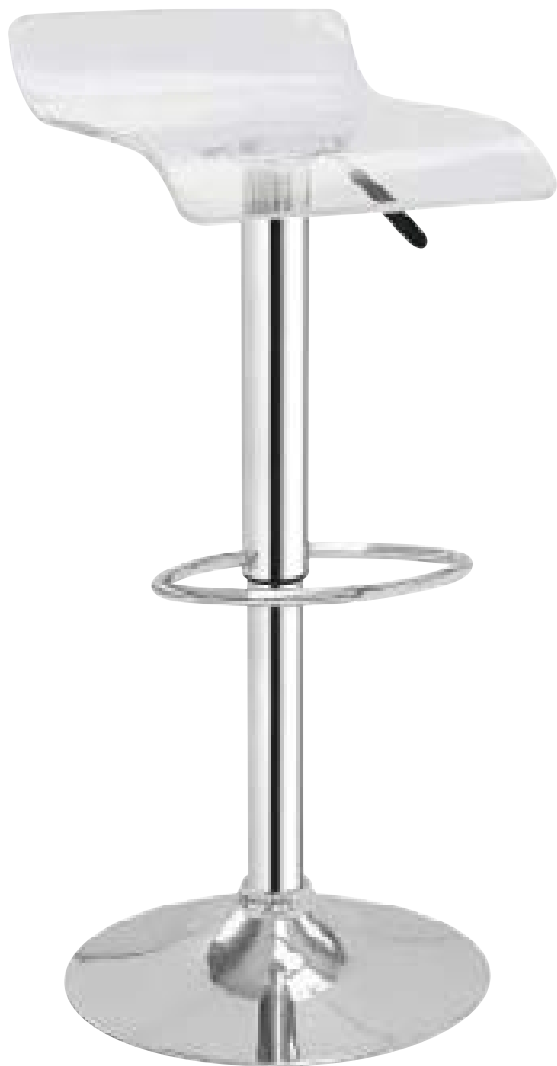

528 - 238A

Struttura in metallo cromato,
seduta in metacrilato

*Chromed metal base, methacrylate
seat*



84,5/64cm 40cm 36cm 77/56,5cm



T-T T-O



531 - 219B

Base in metallo cromato,
scocca in ABS rivestita in ecopelle

*Chromed metal base,
ABS shell, polyurethane covering*





 88/68cm 44cm 40cm 78/58cm



 W N R



419 - IF216

Base in metallo cromato,
seduta in ABS

*Chromed metal base,
ABS seat*

□ □
59/45cm 33cm

□ ■ ▒
W N G



1123 - D600

Struttura in metallo verniciato e grezzo, seduta in ecopelle
Metal frame, powder coating and raw, polyurethane seat



 47cm 37cm







 W N R V Y L

NEW



1665 - TF22

Struttura in metallo verniciato, piano allungabile in cristallo e melamina antigraffio spessore 11 mm
Metal frame, powder coating, 11 mm tempered glass and scratchproof melamine top and extension
(L160+40+40 x P90 x H75 cm)

NEW





1558 - 9TD

Struttura in metallo verniciato,
piano allungabile in cristallo,
spessore 10 mm

*Metal frame, powder coating,
10 mm tempered
glass top and extension*

(L160+40+40 x P90 x H76 cm)

1471 - 9TA

Struttura in metallo verniciato,
piano allungabile in cristallo
effetto pietra
spessore 10,5 mm

*Metal frame, powder coating,
10,5 mm tempered
stoneglass top and extension*

(L160+40+40 x P90 x H76 cm)

1472 - 9TB

Struttura in metallo verniciato,
piano allungabile
in vetroceramica temperato
spessore 14,5 mm

*Metal frame, powder coating,
14,5 mm ceramic tempered
glass top and extension*

(L160+40+40 x P90 x H76 cm)

1473 - 9TC

Struttura in metallo verniciato,
piano allungabile
in vetro-melamina temperato
resistente al fuoco spessore 11 mm

*Metal frame, powder coating,
11 mm melamine tempered
glass top and extension, fire resistant*

(L160/+40+40 x P90 x H76 cm)



struttura / frame

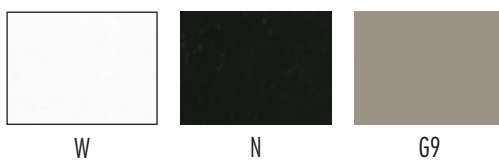

W

N

G9

vetroceramica / ceramic glass



C2D

C4D

cristallo / tempered glass

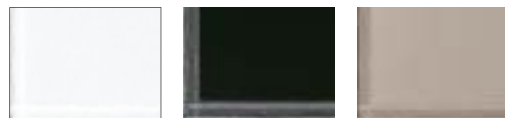

W

N

G9G

cristallo effetto pietra / stoneglass

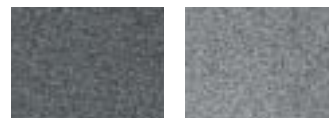

S1D

S2D

vetro-melamina
melamine glass



M2D



1442 - A58

Struttura in metallo verniciato, piano allungabile in cristallo spessore 10 mm

Painted metal frame, 10 mm tempered glass top and extension

(L180/220 x P90 x H76 cm)

struttura / frame

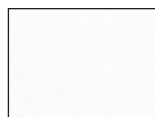

W



N



G9





1445 - A75G

Struttura in metallo verniciato, gambe in legno, piano allungabile in cristallo effetto pietra spessore 10,5 mm

*Metal frame, powder coating, wood legs, 10,5 mm tempered stoneglass top and extension
(L140/200 x P80 x H76 cm)*





1324 - A75
(L160/220 x P90 x H76 cm)

1444 - A75M
(L140/200 x P80 x H76 cm)

Struttura in metallo verniciato, gambe in legno, piano allungabile in MDF verniciato effetto pietra
Metal frame, powder coating, wood legs, top and extension painted in stone color

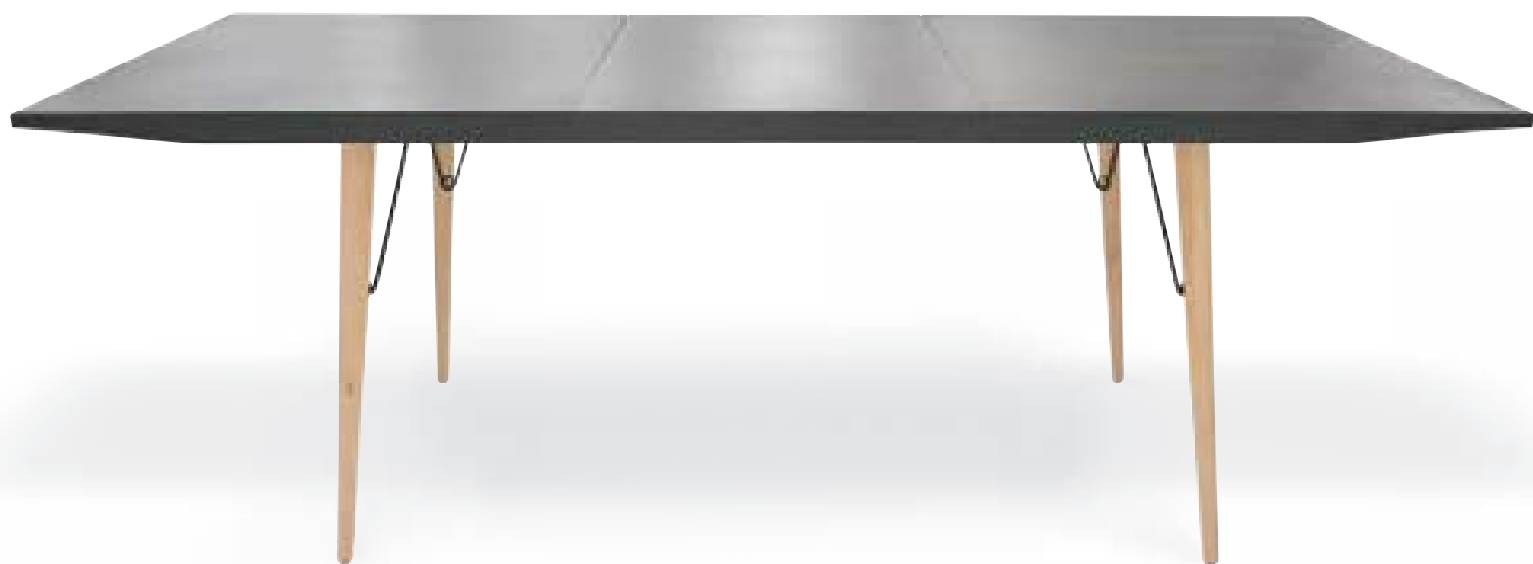

NEW



SEDIA CHAIR
1485 - F50

TAVOLO TABLE
1608 - TOP1

Struttura in metallo verniciato, gambe in legno, piano allungabile in vetroceramica spessore 11 mm
Metal frame, powder coating, solid wood legs, 11 mm ceramic tempered glass top and extension
(L180/230 x P90 x H75 cm)

NEW



NEW



SEDIA CHAIR
1423 - YM2

TAVOLO TABLE
1658 - RI9A

Struttura in metallo verniciato, piano allungabile in vetro acidato spessore 10 mm
10 mm metal frame, powder coating, glazed glass
(L160/240 x P90 x H76 cm)

NEW



NEW



SEDIA *CHAIR*
821 - RF4BC

TAVOLO *TABLE*
1609 - TOP2

Struttura in alluminio, gambe in legno, piano allungabile in cristallo spessore 10 mm
Aluminum frame, solid wood legs, 10 mm tempered glass top
(L160+40+40 x P90 x H75 cm)

NEW



NEW



SEDIA CHAIR
1692 - PA4

TAVOLO TABLE
1610 - TOP3

Struttura in legno, gambe in legno, piano allungabile in MDF impiallacciato
Wood frame, solid wood legs, walnut veneered MDF top and extension
(L160/210 x P90 x H76 cm)

NEW





SEDIA CHAIR
824 - RF97

TAVOLO TABLE
1694 - DE93T

Struttura in metallo verniciato, piano allungabile in vetroceramica spessore 13,5 mm
Metal frame, powder coating, 13,5 mm ceramic tempered glass top and extension
(L160+40+40 x P90 x H76 cm)



1594 - DE86T

Struttura in metallo verniciato, piano allungabile in vetroceramica spessore 11 mm, estensione in MDF laccata

Metal frame, powder coating, 11 mm ceramic tempered glass top, high gloss MDF and extension

(Ø 120+50 x H76 cm)



1539 - WL01

Struttura in metallo verniciato, piano in MDF impiallacciato

Metal frame, powder coating, veneered MDF top

(L198 x P112 x H76 cm)



1447 - T21

Struttura in metallo verniciato, piano in MDF impiallacciato

Metal frame, powder coating, veneered MDF top

(L180 x P95 x H75 cm)

NEW



1621 - MIT83

Struttura in legno, piano in MDF impiallacciato

Rubber wood frame, MDF top with oak veneer

(L180 x P90 x H76 cm)



1675 - MIT82

Struttura in legno, piano in marmo sintetico

Rubber wood frame, synthetic marble top

(L180 x P90 x H76 cm)

NEW



1677 - MIT10

Struttura in metallo verniciato, piano in MDF impiallacciato

Metal frame, powder coating MDF top with ash veneer

(Ø 137 x H76 cm)



1676 - MIT67

Struttura in metallo verniciato, piano in marmo sintetico

Metal frame, powder coating synthetic marble top

(Ø 135 x H76 cm)

NEW



SEDIA CHAIR
1662 - DA4

TAVOLO TABLE
1668 - BA16

Struttura in metallo dorato, piano in legno multistrato impiallacciato
Plating gold metal frame, plywood top with veneer

(L75 x P75 x H75 cm)



SEDIA CHAIR
1661 - DA3

TAVOLO TABLE
1634 - GU33

Struttura in metallo verniciato, base in acciaio inox, piano in MDF impiallacciato
Metal frame, powder coating, stainless steel base, MDF top with veneer

(Ø 120 x H76 cm)



SEDIA *CHAIR*
1456 - 30D

TAVOLO *TABLE*
1450 - 28DT

Struttura in metallo verniciato, piano allungabile in cristallo
spessore 8 mm, estensione in MDF laccato

*Metal frame, powder coating, 8 mm tempered glass top,
extension in MDF painting*

(L140+45+45 x P90 x H76 cm)

cristallo / *temperated glass*

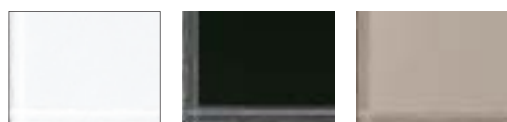

W

N

G9G

struttura & MDF / *frame & MDF*



W

N

G9



1458 - 18DT

Struttura in metallo verniciato,
piano allungabile in MDF laccato

*Metal frame, powder coating,
top and extension in MDF high gloss
(L110/160 x P70 x H76 cm)*



piano MDF / MDF top



W

N

G9G

struttura / frame



W

N

G9



SEDIA CHAIR
824 - RF97

TAVOLO TABLE
1457 - 65DT

Struttura in metallo verniciato, piano allungabile in MDF laccato
Metal frame, powder coating, top and extension in MDF high gloss
(L130/+40+40 x P80 x H76 cm)



piano MDF / MDF top



W

N

G9G

struttura / frame



W

N

G9



SEDIA CHAIR
1451 - 7BD

TAVOLO TABLE
1455 - 75DTG

Struttura in metallo verniciato, piano allungabile
in cristallo spessore 8 mm

*Metal frame, powder coating, 8 mm tempered glass top
and extension*

(L122/182 x P82 x H76 cm)

TAVOLO TABLE
1454 - 75DTC

Struttura in metallo verniciato, piano allungabile
in cristallo effetto pietra spessore 8,5 mm

*Metal frame, powder coating, 8,5 mm tempered stoneglass
top and extension*

(L122/182 x P82 x H76 cm)



struttura / frame

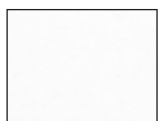

W

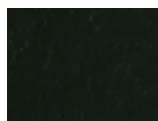

N



G9

cristallo / tempered glass

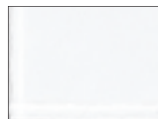

W

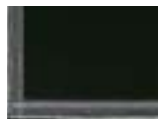

N



G9G

cristallo effetto pietra / stoneglass



J01



J08



J09



1453 - 73DTG

Struttura in metallo verniciato, piano allungabile
in cristallo spessore 8 mm

*Metal frame, powder coating, 8 mm tempered glass top
and extension*

(L120/170 x P80 x H76 cm)

1452 - 73DTC

Struttura in metallo verniciato, piano allungabile
in cristallo effetto pietra spessore 8,5 mm

*Metal frame, powder coating, 8,5 mm tempered
stoneglass top and extension*

(L120/170 x P80 x H76 cm)

1466 - 73DTM

Struttura in metallo verniciato, piano allungabile in vetroceramica
temperato spessore 11,5 mm

*Metal frame, powder coating, 11,5 mm ceramic tempered
glass top and extension*

(L120/170 x P80 x H76 cm)

1467 - 73DTN

Struttura in metallo verniciato, piano allungabile
in vetro-melamina temperato resistente al fuoco spessore 8,5 mm

*Metal frame, powder coating, 8,5 mm melamine tempered
glass top and extension, fire resistant*

(L120/170 x P80 x H76 cm)



struttura / frame



W

N

G9

G1

vetroceramica / ceramic glass



C2D

C4D

cristallo / tempered glass

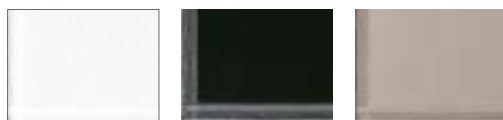

W

N

G9G

cristallo effetto pietra / stoneglass



S2D

S3D

vetro-melamina
melamine glass



M2D



SEDIA CHAIR
824 - RF97

TAVOLO TABLE
1459 - 88DT

Struttura in metallo verniciato,
piano allungabile in cristallo spessore 9 mm
*Metal frame, powder coating,
9 mm tempered glass top and extension
(L120+35+35 x P80 x H76 cm)*



piano MDF / MDF top

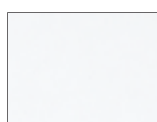

W



N



G9G

struttura / frame

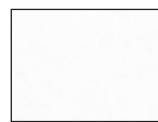

W



N



G9



1460 - 78DT

Struttura in metallo verniciato, piano allungabile in cristallo spessore 8 mm

Metal frame, powder coating, 8 mm tempered glass top and extension

(L120+45+45 x P86 x H75 cm)



cristallo / tempered glass

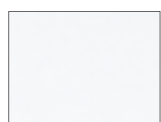

W

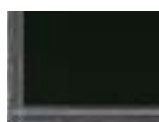

N



G9G



G10G

struttura / frame

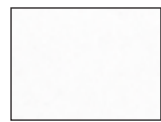

W



N



G9



G10



1461 - 03DT

Struttura in metallo verniciato,
piano allungabile in cristallo spessore 8 mm,
estensione in MDF impiallacciato

*Metal frame, powder coating,
8mm tempered glass,
top and extension in veneered MDF*
(L120+45+45+45 x P80 x H76/43 cm)



cristallo / tempered glass

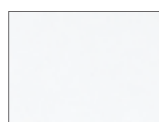

W

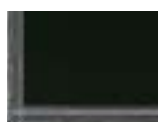

N



G9G



G10G

struttura / frame

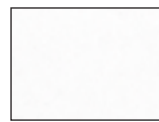

W



N



G9



G10



841 - RF22

Struttura in metallo verniciato, piano allungabile in cristallo spessore 8 mm

Metal frame, powder coating, 8 mm tempered glass top and extension
(100/160 x 70 x 76/45 cm)



W



G





509 - TB015
Struttura in metallo cromato,
piano in MDF
*Chromed metal frame,
veneered MDF top*
(L120 x P80 x H74 cm)



507 - TB007
Struttura in metallo verniciato,
piano in MDF
*Metal frame, powder coating,
veneered MDF top*
(L120 x P80 x H74 cm)



TAVOLO / TABLE

1195 - TB028A
(L70 x P70 x H76 cm)

1196 - TB028B
(L80 x P80 x H76 cm)

1197 - TB028C
(L120 x P80 x H76 cm)

Struttura in metallo cromato,
piano in MDF laccato
*Chromed metal frame,
painted MDF top*



GAMBE / LEGS

1198 - TB028T
Gambe in metallo cromato
Chromed metal legs



1562 - TB08 Struttura in legno multistrato, piano in MDF laccato (L120 x P80 x H75 cm)
Playwood frame, painting MDF top



1563 - TB07
Struttura in legno multistrato,
piano in MDF laccato
Playwood frame, painted MDF top
(L80 x P80 x H75 cm)





938 - K54 (L80 x P80 x H74 cm)

939 - K55 (L120 x P80 x H74 cm)

Struttura in metallo, gambe in legno,
piano in MDF laccato

*Metal frame, powder coating,
solid wood legs, painted MDF top*

piano / top



W

N



1040 - G06
Tavolo in legno
Wood table
(L80 x P80 x H73 cm)



1039 - G05
Tavolo in legno
Wood table
(L80 x P80 x H73 cm)



□ TAVOLO TABLE
 984 - Z80 (Ø 80 cm x 110cm)
 Struttura in metallo verniciato,
 piano in polietilene
*Metal frame, powder coating
 polyethylene top*



985 - Z154 (Ø 154 cm)
 983 - Z183 (Ø 183 cm)
 Struttura pieghevole in metallo verniciato,
 piano in polietilene pieghevole
*Folding metal frame,
 powder coating, folding polyethylene top*



944 - Z152 (153 x 76 cm)
 945 - Z183C (183 x 76 cm)
 Struttura in metallo verniciato,
 piano in polietilene
*Metal frame, powder coating,
 polyethylene top*



537 - CS205

Base in acciaio cromato,
piano in vetro temperato
spessore 13 mm

*Chromed steel base,
13 mm tempered glass
(Ø 70 x H 72 cm)*



510 - BT001G

Struttura in metallo cromato,
piano in vetro temperato

*Chromed metal base,
tempered glass
(Ø 60 cm H 113 cm)*



538 - CS206

(L70 x P70 x H72 cm)

621 - CS207

(L80 x P80 x H72 cm)

Base in acciaio cromato, piano in vetro temperato spessore 13 mm
Chromed steel base, 13 mm tempered glass



302 - BZ023

Composizioni in vetro temperato
spessore 12 mm

12 mm tempered glass set

(L42 x P42 x H42 cm)

(L38 x P38 x H38 cm)

(L34 x P34 x H34 cm)



303 - BZ022

Vetro temperato spessore 12 mm

12 mm tempered glass

(L120 x P60 x H40 cm)

NEW

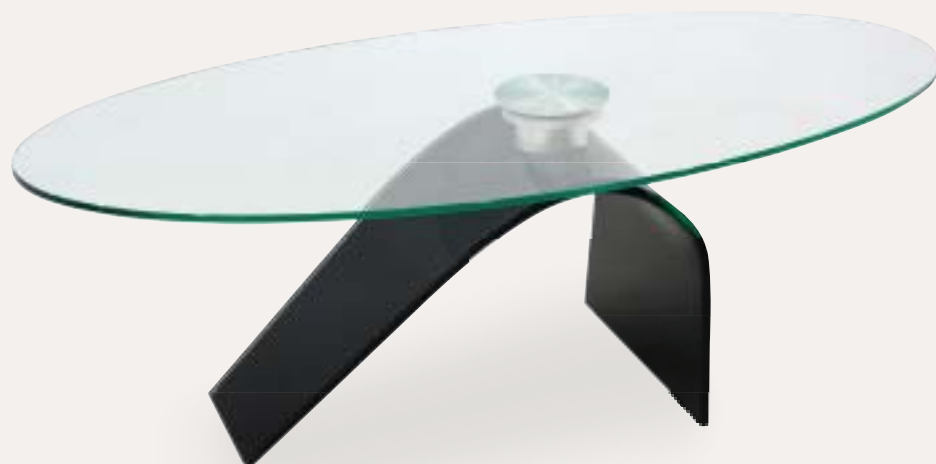

1620 - EL81

Base curva nera in vetro temperato
spessore 15 mm, piano in vetro
temperato spessore 10 mm

*15 mm black bending base in tempered
glass, 10 mm tempered glass top*
(L125 x P65 x H42 cm)



1666 - TF23

Struttura in MDF laccato con inserti
in ceramica, base in metallo verniciato,
piano di ceramica

*Painted MDF frame with stick ceramic,
metal base, powder coating, ceramic top*
(L120 x P60 x H45 cm)

NEW



1653 - B01T

Struttura in metallo cromato,
piano in vetro temperato

*Chromed metal frame,
tempered glass top*

(L60 x P60 x H45 cm)



1671 - BA03

Struttura in metallo verniciato,
piano in legno multistrato impiallacciato

*Metal frame, powder coating,
veneered plywood top*

(Ø 75 cm H44 cm)

NEW



1678 - SE10
(L74,5 x P49,5 x H42,5 cm)

1679 - SE75
(L100 x P49,5 x H42,5 cm)

piano / top



Struttura in metallo verniciato, piano in MDF verniciato
Metal frame, powder coating, painted MDF top



NEW



1681 - SE02

Struttura in metallo verniciato, piano MDF verniciato

Metal frame, powder coating, painted MDF top

(L92x P50 x H40,5 cm)

piano / top



W N G



NEW



1611 - TOP4

Struttura in metallo verniciato, piano in MDF impiallacciato noce
Metal frame, powder coating, walnut veneered MDF top
(L80 x P80 x H47 cm)



1619 - TOP12

Struttura in metallo verniciato, piano in MDF impiallacciato noce
Metal frame, powder coating, walnut veneered MDF top
(L120 x P60 x H35 cm)



1565 - TS7

Struttura in legno multistrato,
piano in MDF laccato

*Playwood frame,
painting MDF top*

(L55 x P55 x H51 cm)

piano / top



W N

gambe / legs



NA W N



Interno

Indoor



**Basi & piani
per tavoli**

***Table bases
& tops***

NEW



1648 - EG3
(52 x 52 x H72 cm) kg 3,7



1644 - S10
(50 x 50 x H72 cm) kg 3,6

Struttura in metallo dorato
Plating gold metal frame



1646 - EG2
(Ø 40 x H72 cm) kg 11,5



1645 - EG1
(40 x 40 x H72 cm) kg 14

NEW



1647 - EC1
Struttura in acciaio inox cromato
Chromed stainless steel frame
(52 x 52 x H72 cm) kg 3,7



1346 - D01
Struttura in legno
e metallo verniciato
Wood and metal frame
(59 x 59 x H72 cm)

NEW



1592 - BAB1
Struttura in metallo verniciato
Metal frame, powder coating
(45 x 45 x H42 cm)

NEW



1680 - BB07
Struttura in legno multistrato
Plywood frame
(67 x 67 x H72 cm)



980 - TB015S (L80 x P80 x H72,5 cm)

986 - TB016S (L120 x P80 x H72,5 cm)

Struttura in metallo cromato

Chromed metal frame



988 - TB015V (L80 x P80 x H72,5 cm)

987 - TB016V (L120 x P80 x H72,5 cm)

Struttura in metallo verniciato

Metal frame, powder coating



1354 - T40RU

Base in ghisa verniciata,
effetto ruggine

*Cast iron base, powder coating,
rust look*

(L40 x P40 x H72 cm) kg. 15

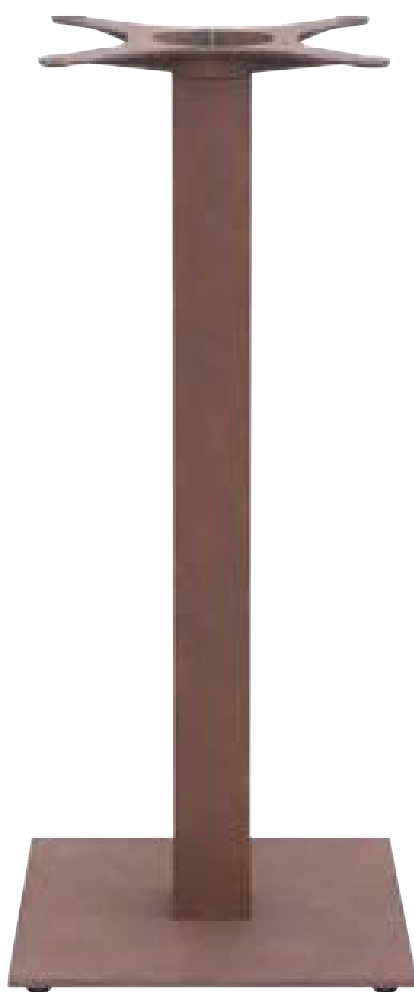

1355 - T40RU

Base in ghisa verniciata,
effetto ruggine

*Cast iron base, powder coating,
rust look*

(L40 x P40 x H108 cm) kg. 17

363 - 6032I
(40 x 40 x H72 cm) kg 15

1572 - 6034I
(50 x 50 x H72 cm) kg 22

Base in acciaio inox satinato,
piedini regolabili

Satin stainless steel base

842 - 6032A

Base in alluminio,
piedini regolabili

Aluminum base

(40 x 40 x H73 cm) kg 15



364 - 6032C
(40 x 40 x H72 cm) kg 15

1571 - 6034C
(50 x 50 x H72 cm) kg 22

Base in acciaio cromato,
piedini regolabili

Chromed steel base

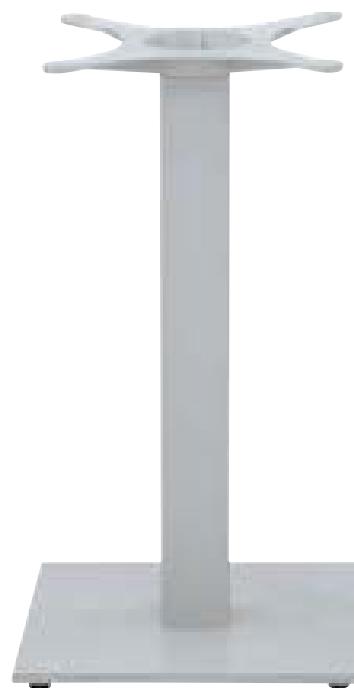
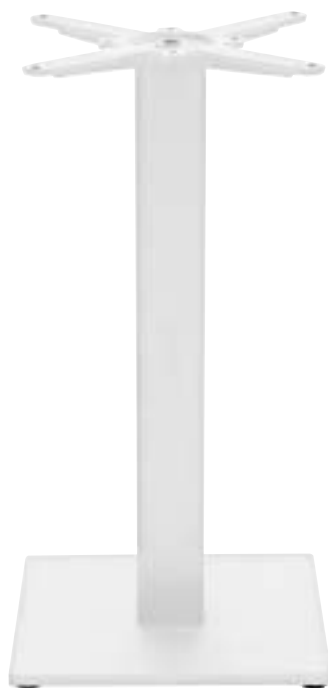
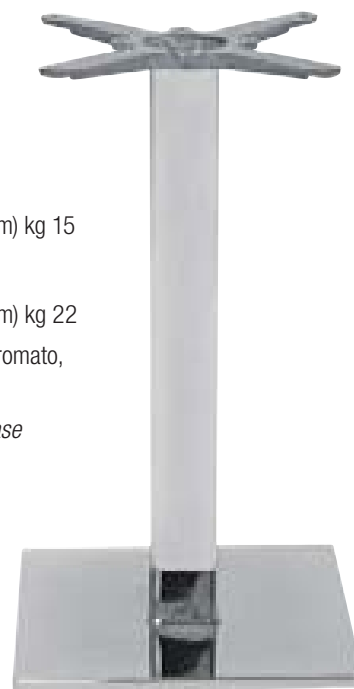

365 - 340N
(40 x 40 x H72 cm) kg 15

1276 - 350N
(50 x 50 x H72 cm) kg 22

Base in ghisa verniciata,
piedini regolabili

*Cast iron base,
powder coating*



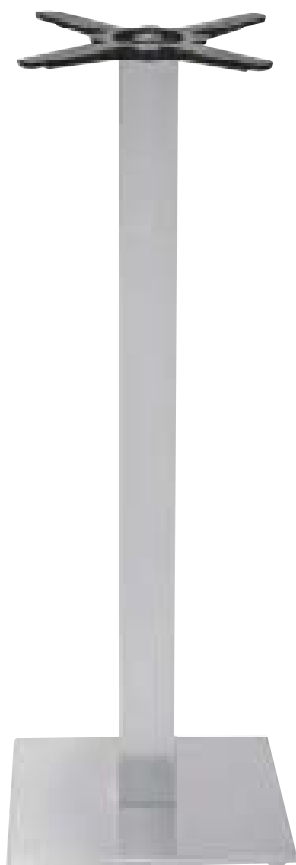

400 - 339HI
Base in acciaio inox satinato, piedini regolabili

Satin stainless steel base
(40 x 40 x H108 cm) kg 17

856 - 339HA
Base in alluminio, piedini regolabili

Aluminum base
(40 x 40 x H108 cm) kg 17

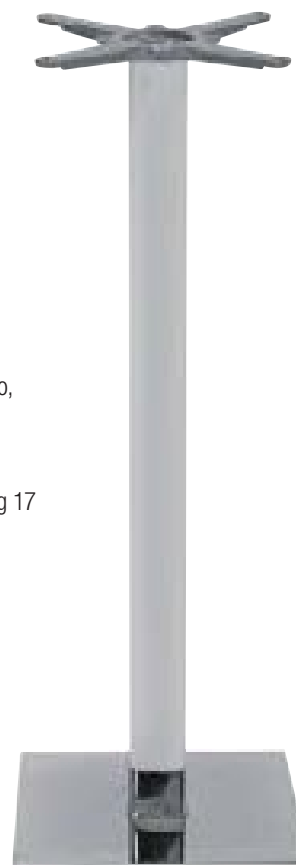

401 - 339HC
Base in acciaio cromato, piedini regolabili

Chromed steel base
(40 x 40 x H108 cm) kg 17



749 - 33940H
Base in ghisa verniciata, piedini regolabili



Cast iron base, powder coating
(40 x 40 x H108 cm) kg 17

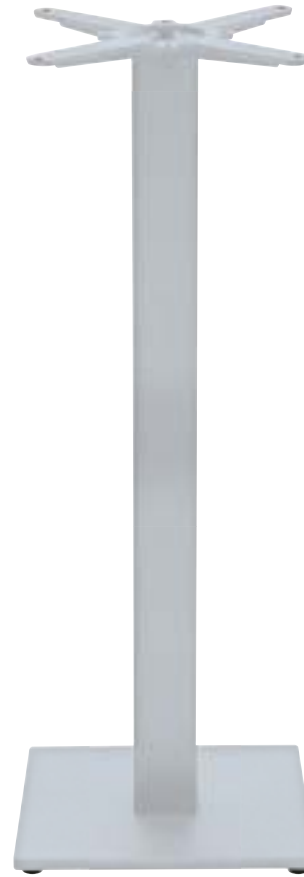

411 - 6028I
(Ø 40 x H73 cm) kg 12

1272 - 6050L
(Ø 50 x H73 cm) kg 15

771 - E18SG
(Ø 58 x H73 cm) kg 17,5

Base in acciaio inox satinato,
piedini regolabili

Satin stainless base

1529 - 18L
(Ø 40 x H73 cm) kg 12

1531 - 18X
(Ø 58 x H73 cm) kg 15

Base in alluminio,
piedini regolabili

Aluminum base

414 - 6028C
(Ø 40 x H73 cm) kg 12

405 - DC400C
(Ø 50 x H73 cm) kg 15

407 - DC600C
(Ø 58 x H73 cm) kg 18

Base in acciaio cromato,
piedini regolabili

Chromed steel base



360 - 340N
Base in ghisa verniciata,
piedini regolabili

*Cast iron base,
powder coating*

(Ø 40 x H72 cm) kg 14

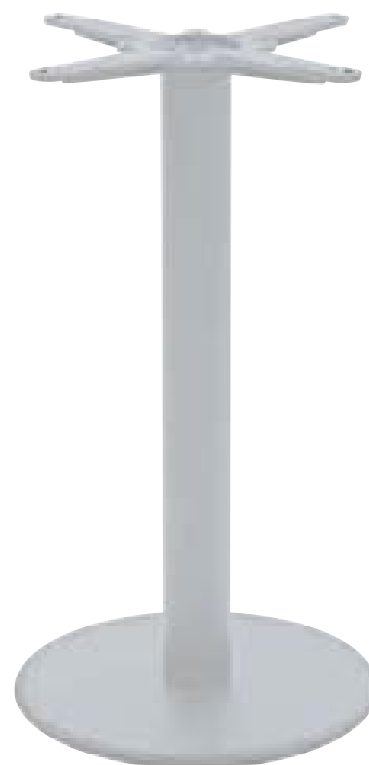
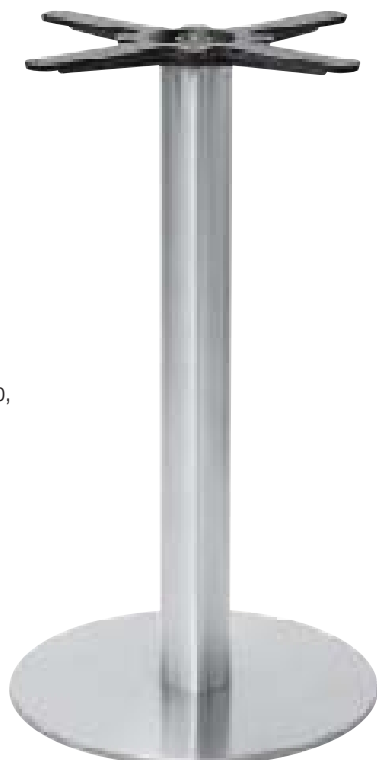

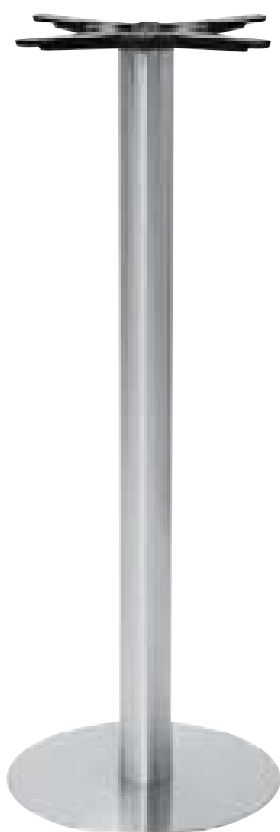

398 - 6029I

Base in acciaio inox satinato, piedini regolabili

Satin stainless steel base

(Ø 40 x H110 cm) kg 13,5

1530 - 18LH

Base in alluminio, piedini regolabili

Aluminum base

(Ø 40 x H110 cm) kg 13,5



399 - 6029C

Base in acciaio cromato, piedini regolabili

Chromed steel base

(Ø 40 x H110 cm) kg 13,5



748 - 34040H

Base in ghisa verniciata, piedini regolabili

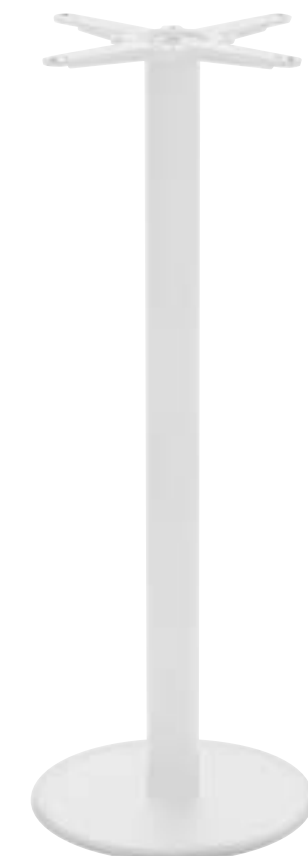

Cast iron base, powder coating

(Ø 40 x H110 cm) kg 13,5

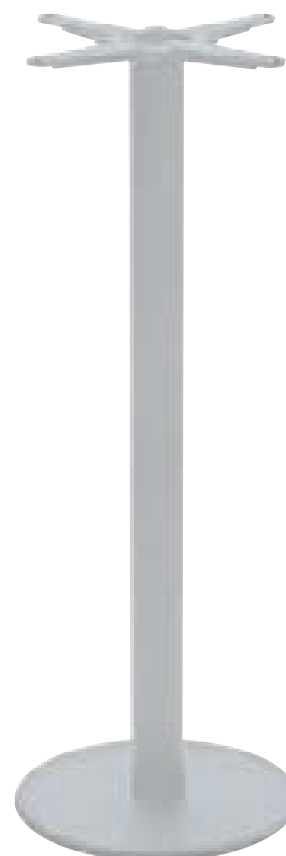

W

N

G



165 - CI159
Base in ghisa verniciata,
piedini regolabili
Cast iron base, powder coating
(42,5 x 42,5 x H 73 cm) Kg 15



166 - CI160
Base in ghisa verniciata,
piedini regolabili
*Cast iron base,
powder coating*
(40 x 55 x H73 cm) kg 19



779 - TB131
Base in ghisa verniciata,
piedini regolabili
*Cast iron base,
powder coating*
(40 x 60 x H73 cm) kg 19



159 - CI110A
(Ø 42,5 x H 73 cm) kg 15

160 - CI110B
(Ø 55 x H 73 cm) kg 21

Base in ghisa verniciata, piedini regolabili
Cast iron base, powder coating



324 - CI110C
Base in ghisa verniciata, piedini regolabili
Cast iron base, powder coating
(Ø 42,5 x H108 cm) kg 17



402 - 6033I
Base in acciaio inox satinato, piedini regolabili
Satin stainless steel base
(40 x 75 x H73 cm) kg 33



773 - 341C
Base in acciaio cromato, piedini regolabili
Chromed steel base
(40 x 70 x H72 cm) kg 33



Base in ghisa verniciata,
piedini regolabili

*Cast iron base,
powder coating*

403 - 341M

(40 x 70 x H72 cm) kg 28



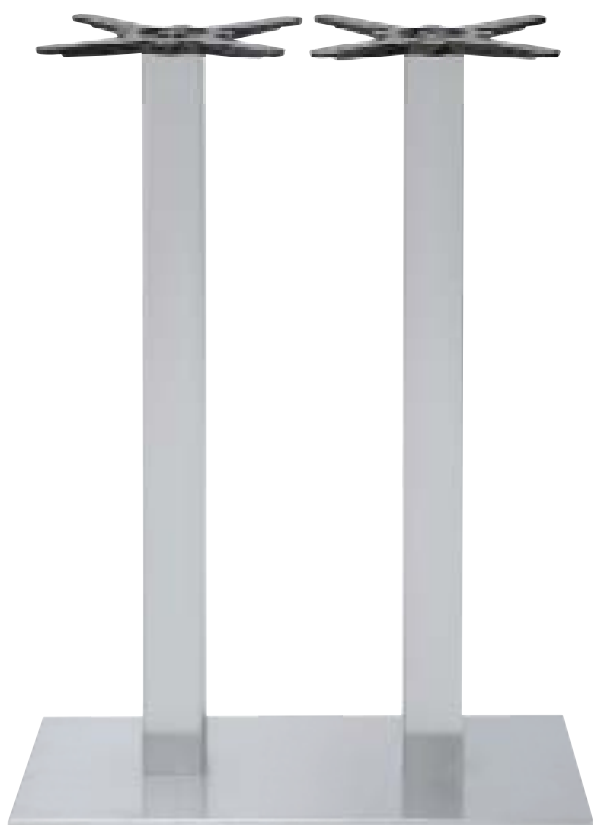

1576 - 6033IH

Base in acciaio inox satinato, piedini regolabili

Satin stainless steel base

(40 x 75 x H108 cm) kg 35

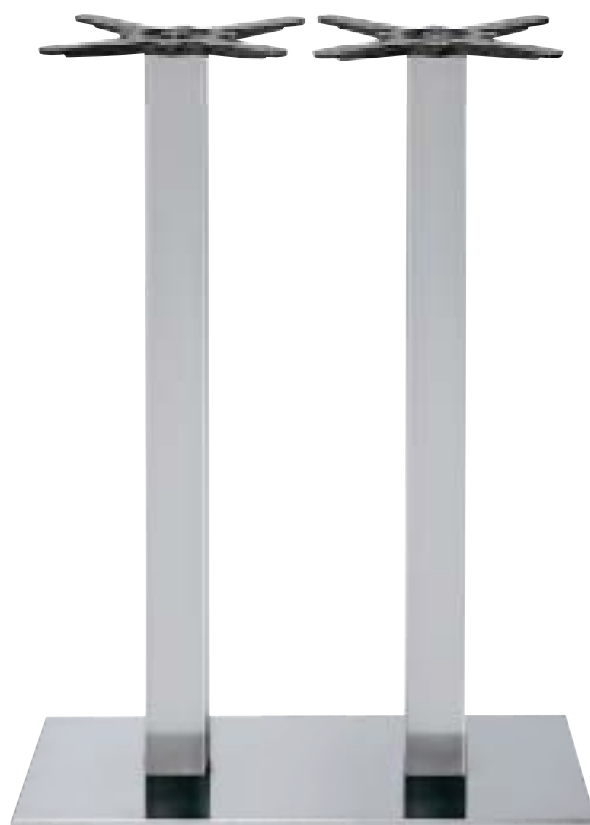

1577 - 341CH

Base in acciaio cromato, piedini regolabili

Chromed steel base

(40 x 75 x H108 cm) kg 35

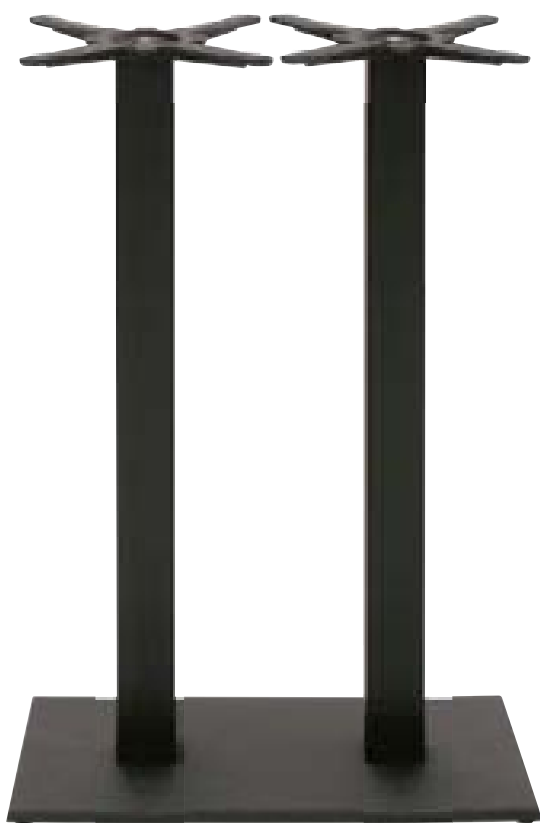

1578 - 341MH

Base in ghisa verniciata, piedini regolabili

Cast iron base, powder coating

(40 x 70 x H108 cm) kg 30





156 - CI129
Base in ghisa verniciata,
piedini regolabili
Cast iron base, powder coating
(42,5 x 42,5cm x H 73 cm) Kg. 15,70



157 - CI130
Base in ghisa verniciata
Cast iron base, powder coating
(Ø 42,5cm x H 73 cm) Kg. 15



1088 - TB119
Base in ghisa verniciata
Cast iron base, powder coating
(79cm x 40cm x H 73 cm) Kg. 32,5



366 - 313

Base in ghisa verniciata,
pedini regolabili

Cast iron base, powder coating
(Ø 42,5 x H73 cm) kg 18





1351 - T11BR
(H71 cm) kg 12,5



Struttura in ghisa verniciata,
effetto bronzo
*Cast iron frame, powder coating,
bronze look*

1353 - T11HBR
(H108 cm) kg 15

169 - CI155-3
(H 71cm) kg 11,5



Struttura in ghisa verniciata
Cast iron frame, powder coating

170 - CI155-4
(H 71cm) kg 12,5



661 - 205H
(H 108 cm) kg 13,5



Struttura in ghisa verniciata
Cast iron frame, powder coating

660 - 210H
(H 108 cm) kg 15





152 - CA101 (H 70 cm)



1273 - CA108 (H108 cm)



153 - CA102 (H 70 cm)

Struttura in alluminio verniciato
Aluminum frame, powder coating



154 - CA101B
(H 70 cm)

Basi in alluminio,
verniciato bambù
*Aluminum bases,
bamboo look*



155 - CA102B
(H 70 cm)



611 - F3

Base in alluminio accatastabile
con accessorio pieghevole e
piedini regolabili

Stackable aluminum base

(H 72 cm) kg 6,2



W AL N T



1341 - E91

Base in alluminio accatastabile
con accessorio pieghevole
e piedini regolabili

Stackable aluminum base

(H72 cm)



W AL N



774 - HF3

Base in alluminio accatastabile con accessorio pieghevole e piedini regolabili

Stackable aluminum base

(H 110 cm) kg 6,8





973 - TP

Base in alluminio verniciato, piedini regolabili

Aluminum base powder coating

(H 70 cm) kg 7,3



920 - MTB013

Base in alluminio verniciato, piedini regolabili

Aluminum base powder coating

(H 70 cm)





974 - THP

Base in alluminio verniciato, piedini regolabili

Aluminum base powder coating

(H 110 cm) kg 7,7





179 - CS2013
(H 71 cm) Kg 6,5



180 - CS2014
(H 71 cm) Kg 8,5



450 - MTB012
(H 108 cm) Kg 9,5



919 - MTB014
(H 71 cm) Kg 9,10

Struttura in alluminio,
acciaio e ghisa, piedini regolabili
*Stainless steel covering base
and aluminum tube*



1344 - E90

Base in alluminio con accessorio
pieghevole e piedini regolabili

Aluminum base
(H72 cm)





138 - L
(H 103 cm)

Struttura in alluminio,
piedini regolabili
Aluminum bases



133 - D
(H 70 cm)



136 - B
(H 70 cm)



132 - E
(H 70 cm)



134 - C
(H 70 cm)



135 - A
(H 70 cm)



140 - F
(H 70 cm)



137 - H
(H 103 cm)

Struttura in alluminio,
pedini regolabili
Aluminum bases



141 - NA Struttura in alluminio H71 cm,
tubo Ø 25 x 1,5 mm, per
piano Ø 60 cm
*Aluminum frame H71 cm,
tube Ø 25 x 1,5 mm,
for top Ø 60 cm*

142 - NB Struttura in alluminio H71 cm,
tubo Ø 28x1,8 mm,
per piano Ø 70 cm
*Aluminum frame H71 cm,
tube Ø 28 x 1,8 mm,
for top Ø 70 cm*



143 - OA Struttura in alluminio H71 cm,
tubo Ø 25 x 1,5 mm,
per piano 60 x 60 cm
*Aluminum frame H71 cm,
tube Ø 25 x 1,5 cm,
for top 60 x 60 cm*

144 - OB Struttura in alluminio H71cm,
tubo Ø 28 x 1,8 mm,
per piano 70 x 70 cm
*Aluminum frame H71 cm,
tube Ø 28 x 1,8 mm,
for top 70 x 70 cm*

145 - OC Struttura in alluminio H71 cm,
tubo Ø 28 x 1,8 mm,
per piano 80 x 80 cm
*Aluminum frame H71 cm,
tube Ø 28 x 1,8 mm,
for top 80 x 80 cm*

843 - OD Struttura in alluminio H71 cm,
tubo Ø 28 x 1,8 mm,
per piano 120 x 80 cm
*Aluminum frame H71 cm,
tube Ø 28 x 1,8 mm,
for top 120 x 80 cm*



1412 - TB77 (L70 x P70 x H73 cm)

1413 - TB78 (L80 x P80 x H73 cm)

1414 - TB79 (L90 x P90 x H73 cm)

1415 - TB712 (L120 x P80 x H73 cm)

Struttura in alluminio verniciato,
piedini regolabili

Aluminum frame, powder coating



1701 - MB76 (L53 x P53 x H72 cm)

1702 - MB77 (L64 x P64 x H72 cm)

1703 - MB78 (L74 x P74 x H72 cm)

Struttura in alluminio verniciato

Aluminum frame, powder coating





656 - 340R

Base in alluminio, rivestimento
in piattina di polietilene

*Aluminum base, polyethylene
thread covering*

(Ø40 x H72 cm) kg 12,7

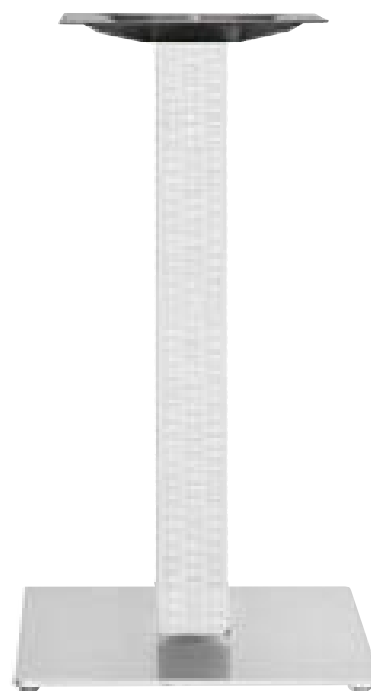

658 - 339Q

Base in alluminio, rivestimento
in piattina di polietilene

*Aluminum base, polyethylene
thread covering*

(40 x 40 x H72 cm) kg 15,8

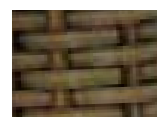

W

N

M



1349 - B80

Struttura in polipropilene,
zavorra in metallo

*Polypropylene frame,
ballast metal round plate*
(Ø40 x H72 cm) kg 11

□ ■
W N

PIANI IN BAMBÙ
BAMBOO TOPS

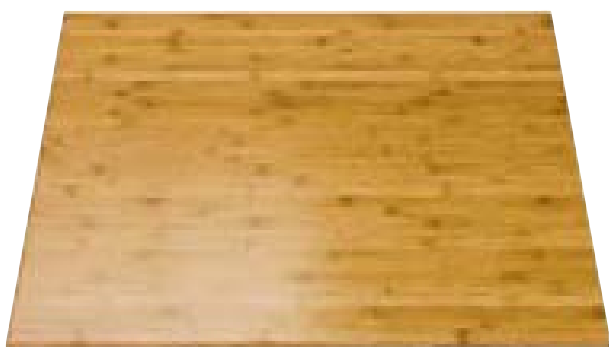

420 - BAS1 (60 x 60 cm)
421 - BAS2 (70 x 70 cm)
422 - BAS3 (80 x 80 cm)
423 - BAS4 (120 x 70 cm)

456 - BAR1 (Ø 60 cm)
457 - BAR2 (Ø 70 cm)
458 - BAR3 (Ø 80 cm)

PIANI IN TEAK
TEAK TOPS



1216 - TGF258A (Ø 60 cm)
1217 - TGF258B (Ø 70 cm)
1218 - TGF258C (Ø 80 cm)

1219 - TGF260A (60 x 60 cm)
1220 - TGF260B (70 x 70 cm)
1221 - TGF260C (80 x 80 cm)
1224 - TGF257C (120 x 70 cm)
1223 - TGF257B (120 x 80 cm)

PIANI IN ACCIAIO
STAINLESS STEEL TOPS

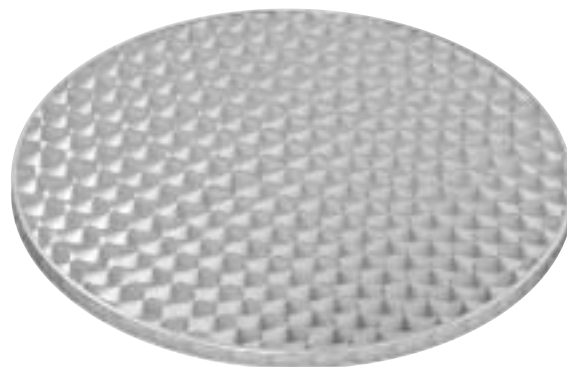
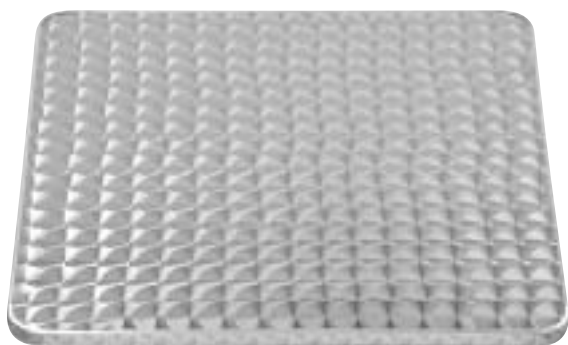

190 - MAS1 (60 x 60cm) (K)
 191 - MAS2 (70 x 70cm) (K)
 192 - MAS3 (80 x 80cm) (K)
 194 - MAS5 (120 x 70cm)
 776 - MAS7 (120 x 80cm) (K)

187 - MAR1 (Ø 60 cm) (K)
 188 - MAR2 (Ø 70 cm) (K)
 189 - MAR3 (Ø 80 cm) (K)

(K) Per uso esterno

PIANI IN DOGHE DI LEGNO BORDATI IN ALLUMINIO
WOOD BAND TOPS, ALUMINUM EDGE



199 - MLS1 (60 x 60 cm)
 200 - MLS2 (70 x 70 cm)
 201 - MLS3 (80 x 80 cm)
 203 - MLS5 (120 x 70 cm)

196 - MLR1 (Ø 60 cm)
 197 - MLR2 (Ø 70 cm)
 198 - MLR3 (Ø 80 cm)

PIANI PER ESTERNO "ALFA"
OUTDOOR TOPS "ALFA"



BLANC



ALU



KROMY
ORANGE



KROMY
ROUGE



KROMY
VERT



634 - R060 (Ø 60 cm)

635 - R070 (Ø 70 cm)

636 - R080 (Ø 80 cm)

630 - SQ60 (60 x 60 cm)

631 - SQ70 (70 x 70 cm)

632 - SQ80 (80 x 80 cm)

633 - SQ120 (120 x 80 cm)

PIANI PER ESTERNO "ALFA"
OUTDOOR TOPS "ALFA"



KROMY
NOIR



ANTRACITE



CALVADOS



TECK



TRAVERTIN



634 - R060 (Ø 60 cm)

635 - R070 (Ø 70 cm)

636 - R080 (Ø 80 cm)

630 - SQ60 (60 x 60 cm)

631 - SQ70 (70 x 70 cm)

632 - SQ80 (80 x 80 cm)

633 - SQ120 (120 x 80 cm)

PIANI PER ESTERNO "ALFA"
OUTDOOR TOPS "ALFA"



MOHOGANY



PAUSSADE
GRIS

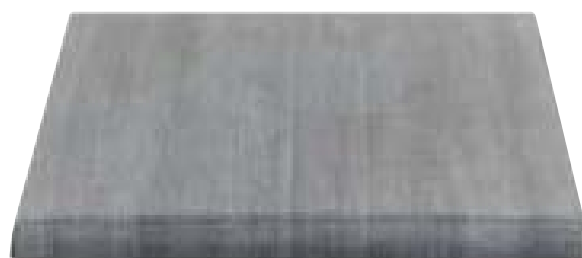

PAUSSADE
LODGE



SILK
ANTRACITE



WENGHE



634 - R060 (Ø 60 cm)

635 - R070 (Ø 70 cm)

636 - R080 (Ø 80 cm)

630 - SQ60 (60 x 60 cm)

631 - SQ70 (70 x 70 cm)

632 - SQ80 (80 x 80 cm)

633 - SQ120 (120 x 80 cm)

PIANI PER ESTERNO "ALFA"
 OUTDOOR TOPS "ALFA"

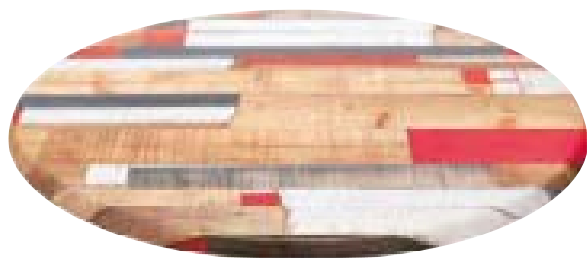

KBANA
 ROUGE

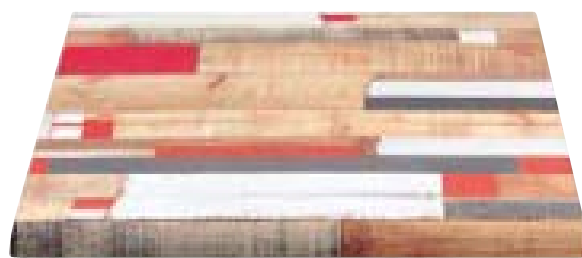

KBANA
 TAUPE



KANSAS



VIRGINIA

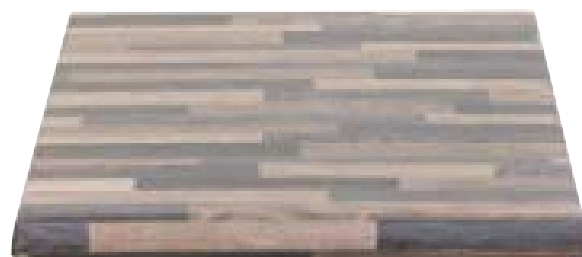

KENTUCKY



- 634 - R060 (Ø 60 cm)
- 635 - R070 (Ø 70 cm)
- 636 - R080 (Ø 80 cm)

- 630 - SQ60 (60 x 60 cm)
- 631 - SQ70 (70 x 70 cm)
- 632 - SQ80 (80 x 80 cm)
- 633 - SQ120 (120 x 80 cm)

PIANI PER ESTERNO "ALFA"
OUTDOOR TOPS "ALFA"



CALIFORNIE



MARITIMO PINE



NEWSPAPER



VINTAGE

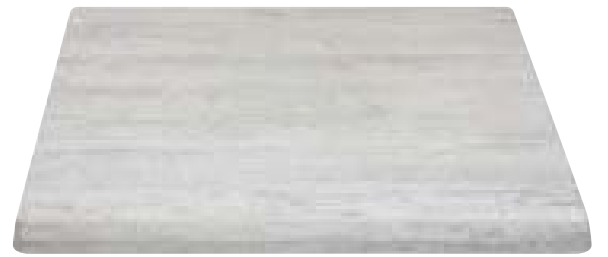

PETROL



634 - R060 (Ø 60 cm)

635 - R070 (Ø 70 cm)

636 - R080 (Ø 80 cm)

630 - SQ60 (60 x 60 cm)

631 - SQ70 (70 x 70 cm)

632 - SQ80 (80 x 80 cm)

633 - SQ120 (120 x 80 cm)

PIANI PER ESTERNO "EXTRA"
OUTDOOR TOPS "EXTRA"



WASHINGTON



MESSINA



CYPRUS



DARK SLATE



634 - R060 (Ø 60 cm)

635 - R070 (Ø 70 cm)

636 - R080 (Ø 80 cm)

630 - SQ60 (60 x 60 cm)

631 - SQ70 (70 x 70 cm)

632 - SQ80 (80 x 80 cm)

633 - SQ120 (120 x 80 cm)

PIANI IN STRATIFICATO HPL
HPL PRESSURE LAMINATE TOPS



ANTRACITE / ANTHRACITE

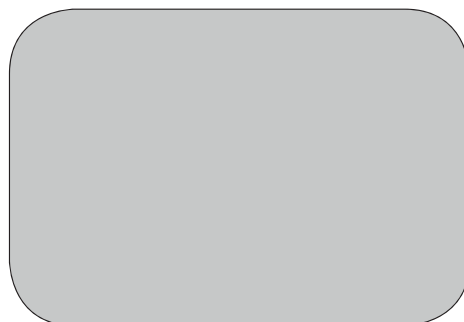

GRIGIO / GREY

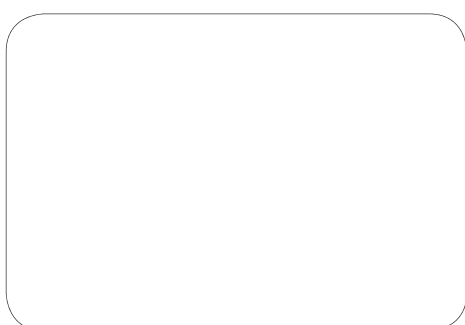

BIANCO / WHITE

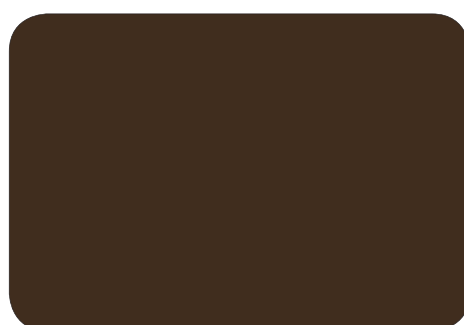

MOKA / MOKA



NERO / BLACK



ALLUMINIO / ALUMINUM

spessore / thickness
10 mm

- | | |
|------------------------|-----------------------------|
| 1704 - ART59 (Ø 60 cm) | 1707 - AST59 (60 x 60 cm) |
| 1705 - ART69 (Ø 70 cm) | 1708 - AST69 (70 x 70 cm) |
| 1706 - ART79 (Ø 80 cm) | 1709 - AST79 (80 x 80 cm) |
| | 1710 - AST119 (120 x 80 cm) |

spessore / thickness
12 mm

- | | |
|----------------------|---------------------------|
| 848 - RT59 (Ø 60 cm) | 844 - ST59 (60 x 60 cm) |
| 849 - RT69 (Ø 70 cm) | 845 - ST69 (70 x 70 cm) |
| 850 - RT79 (Ø 80 cm) | 846 - ST79 (80 x 80 cm) |
| | 847 - ST119 (120 x 80 cm) |

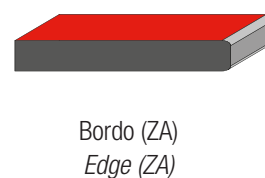
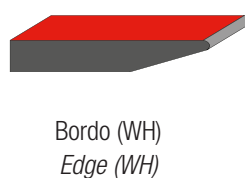
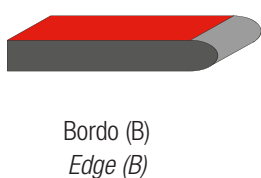
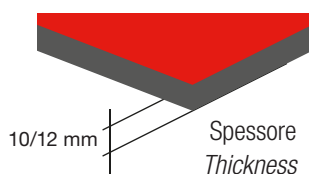

PIANI IN STRATIFICATO HPL
HPL PRESSURE LAMINATE TOPS



WENGÉ



GREY WOOD



METALLIC



SLEEK GREY



SLEEK LIGHT GREY



BROOKLYN DARK



COPPER PAINTED



SLATE

PIANI IN LAMINATO / LAMINATE TOPS



BIANCO LARIX 9003

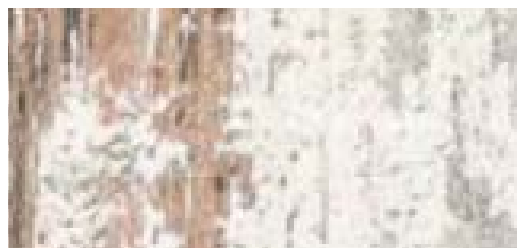

VINTAGE 6300



ROVERE SBIANCATO 1014

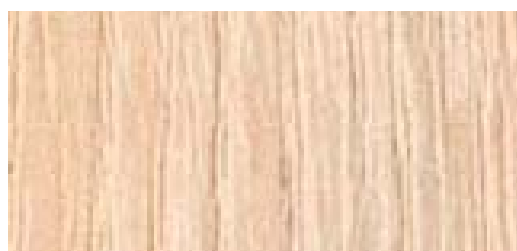

ROVERE NATURALE 1001

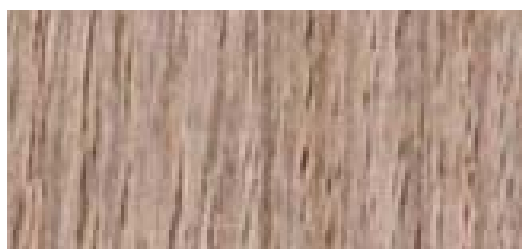

ROVERE GRIGIO MEDIO 7006



OLMO GRIGIO SCURO 7022

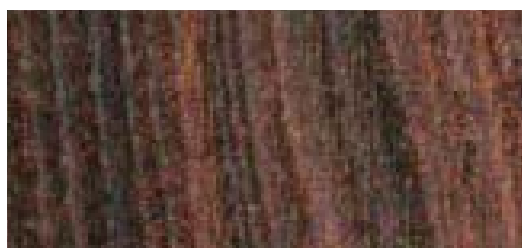

OLMO TINTO 8028

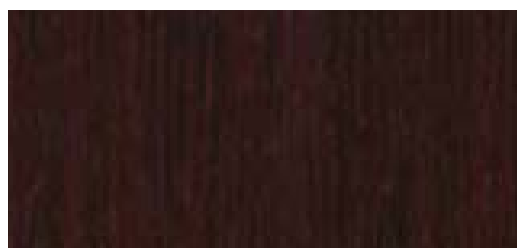

WENGE 8019

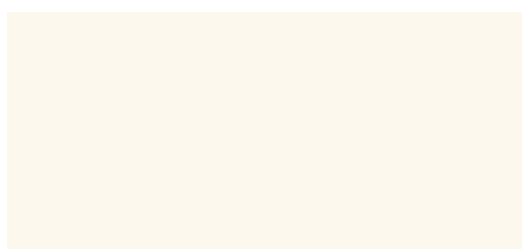

BIANCO



GRIGIO CHIARO

PIANI IN LAMINATO / LAMINATE TOPS

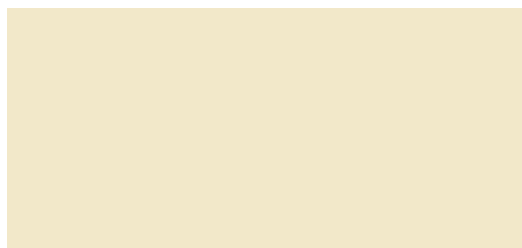

MAGNOLIA

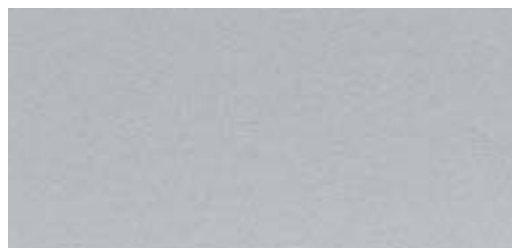

ALLUMINIO



ANTRACITE

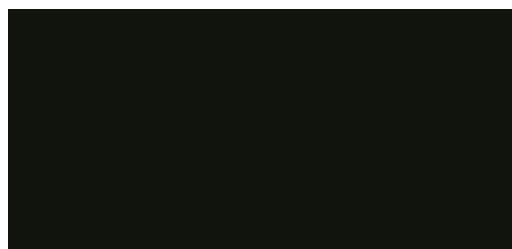

NERO

BORDO ABS IN TINTA
ABS EDGE

SPESSORE 24mm / THICKNESS 24mm

1356 - ST60 (60 x 60 cm)	1360 - RT60 (Ø 60 cm)
1357 - ST70 (70 x 70 cm)	1361 - RT70 (Ø 70 cm)
1358 - ST80 (80 x 80 cm)	1362 - RT80 (Ø 80 cm)
1359 - ST120 (120 x 80 cm)	

SPESSORE 30mm / THICKNESS 30mm

1363 - ST63 (60 x 60 cm)	1367 - RT63 (Ø 60 cm)
1364 - ST73 (70 x 70 cm)	1368 - RT73 (Ø 70 cm)
1365 - ST83 (80 x 80 cm)	1369 - RT83 (Ø 80 cm)
1366 - ST123 (120 x 80 cm)	

SPESSORE 40mm / THICKNESS 40mm

1370 - ST64 (60 x 60 cm)	1374 - RT64 (Ø 60 cm)
1371 - ST74 (70 x 70 cm)	1375 - RT74 (Ø 70 cm)
1372 - ST84 (80 x 80 cm)	1376 - RT84 (Ø 80 cm)
1373 - ST124 (120 x 80 cm)	

SPESSORE 50mm / THICKNESS 50mm

1377 - ST65 (60 x 60 cm)	1381 - RT65 (Ø 60 cm)
1378 - ST75 (70 x 70 cm)	1382 - RT75 (Ø 70 cm)
1379 - ST85 (80 x 80 cm)	1383 - RT85 (Ø 80 cm)
1380 - ST125 (120 x 80 cm)	

BORDO IN GOMMA
RUBBER EDGE

SPESSORE 24mm / THICKNESS 24mm

1384 - STG60 (60 x 60 cm)	1388 - RTG60 (Ø 60 cm)
1385 - STG70 (70 x 70 cm)	1389 - RTG70 (Ø 70 cm)
1386 - STG80 (80 x 80 cm)	1390 - RTG80 (Ø 80 cm)
1387 - STG120 (120 x 80 cm)	

SPESSORE 27mm / THICKNESS 27mm

1391 - STG62 (60 x 60 cm)	1395 - RTG62 (Ø 60 cm)
1392 - STG72 (70 x 70 cm)	1396 - RTG72 (Ø 70 cm)
1393 - STG82 (80 x 80 cm)	1397 - RTG82 (Ø 80 cm)
1394 - STG122 (120 x 80 cm)	

SPESSORE 30mm / THICKNESS 30mm

1398 - STG63 (60 x 60 cm)	1402 - RTG63 (Ø 60 cm)
1399 - STG73 (70 x 70 cm)	1403 - RTG73 (Ø 70 cm)
1400 - STG83 (80 x 80 cm)	1404 - RTG83 (Ø 80 cm)
1401 - STG123 (120 x 80 cm)	

PIANI IN MELAMMINICO & LAMINATO PERSONALIZZATI
CUSTOM MADE MELAMINE & LAMINATED TOPS

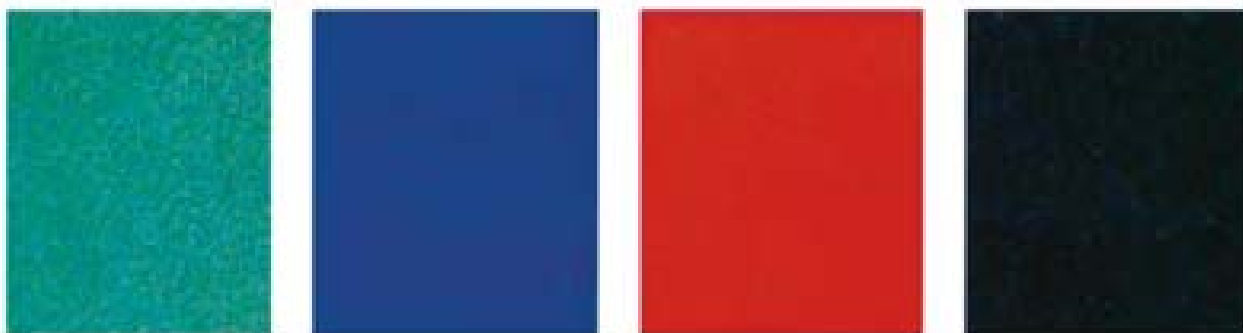

Caratteristiche richieste:

- Dimensioni
- Spessore
- Legno multistrato o panforte
- Colore
- Bordo

Requested characteristics:

- Sizes
- Thickness
- Multilayer wood or play wood
- Colours
- Edge

PER I COLORI DEI PIANI IN LAMINATO CONSULTARE I SITI:
FOR THE LAMINATED TOP COLOURS LOOK UP THE SITES:

www.abet-laminati.it
www.arpaindustriale.com

PIANI IN STRATIFICATO HPL PERSONALIZZATI
CUSTOM MADE HPL PRESSURE LAMINATE TOPS

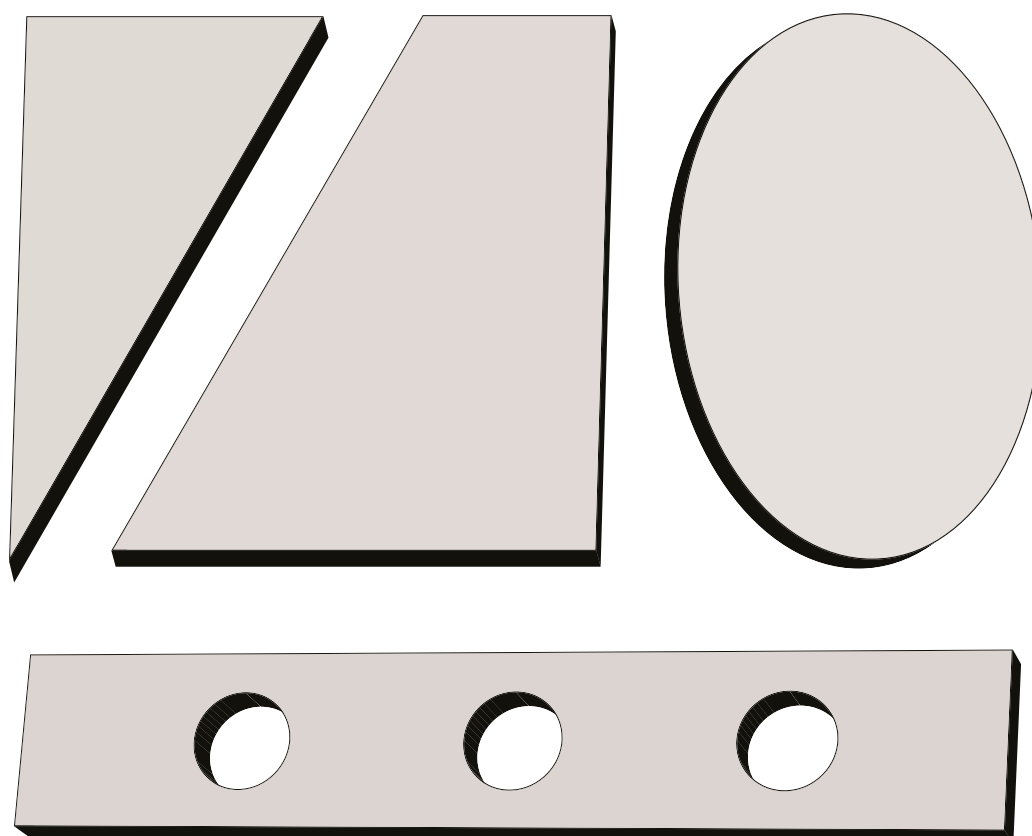

Caratteristiche richieste:

- Dimensioni
- Spessore (10-12 mm)
- Colore (vedi pag. 408-409)
- Bordo (vedi pag. 408)

Requested characteristics:

- Sizes
- Thickness (10-12 mm)
- Colours (pages 408-409)
- Edge (page 408)



**Basi & piani
per tavoli**

***Table bases
& tops***



**Arredi
luminosi**

***Light
furniture***

Gli arredi luminosi a led che vi proponiamo sono adatti per qualsiasi locale pubblico di intrattenimento e di ospitalità, dove possono essere impiegati sia per uso esterno che interno. La coreografia che vengono a creare grazie all'alternanza dei colori permette di rendere più suggestivi e attraenti bar, pub, discoteche, ristoranti, piscine, hotel ecc.

Caratteristiche:

- involucro in polietilene di alta qualità molto resistente
- luci a led con alimentazione a batteria incorporata, i led hanno un bassissimo consumo 40%-80% meno delle lampade tradizionali e una lunga durata
- tempo di carica delle batterie 4-8 ore
- durata della carica 8-10 ore
- il comando delle luci avviene a mezzo telecomando, con la possibilità di scegliere fra 16 colori oppure alternandoli automaticamente
- caratteristiche di impermeabilità all'acqua pari a IP54 / IP65.

The bright LED fittings are suitable for any public venue.

The choreography, which are created by alternating the colors, makes it more beautiful and attractive bars, pubs, discos, restaurants, swimming pools, hotels etc...

Characteristics:

- *Housing made of polyethylene of high quality durable*
- *LED lights built-in battery-powered*
- *Battery charging time 4-8 hours*
- *Charging time 8-10 hours*
- *The command is done by remote control of lights, with a choice of 16 colors or alternating them automatically*
- *Features water resistance equivalent to IP54 / IP65.*



2000 - NJ1530L
(L40 x P40 x H40 cm)



2002 - NJ1535
(Ø 42 x H45 cm)



2015 - BZFL010
Con RGB
With RGB
(L47 x P47 x H90 cm)





2009 - NJ1531
(L45 x P45 x H54 cm)



2026 - BZCH5506L
(Ø 54 cm x H54 cm)



2019 - BZBE302
(Ø 34 x H27 cm)





2031 - BZ0107L
(Ø 40 cm) Con RGB
With RGB

2032 - BZ0108L
(Ø 61 cm) Con RGB
With RGB

2033 - BZ0109L
(Ø 85 cm) Con RGB
With RGB



2059 - MD11
(L46 x P46,5 x H86 cm)





2030 - NM1632
Con RGB
With RGB
(L160 x P72 x H102 cm)

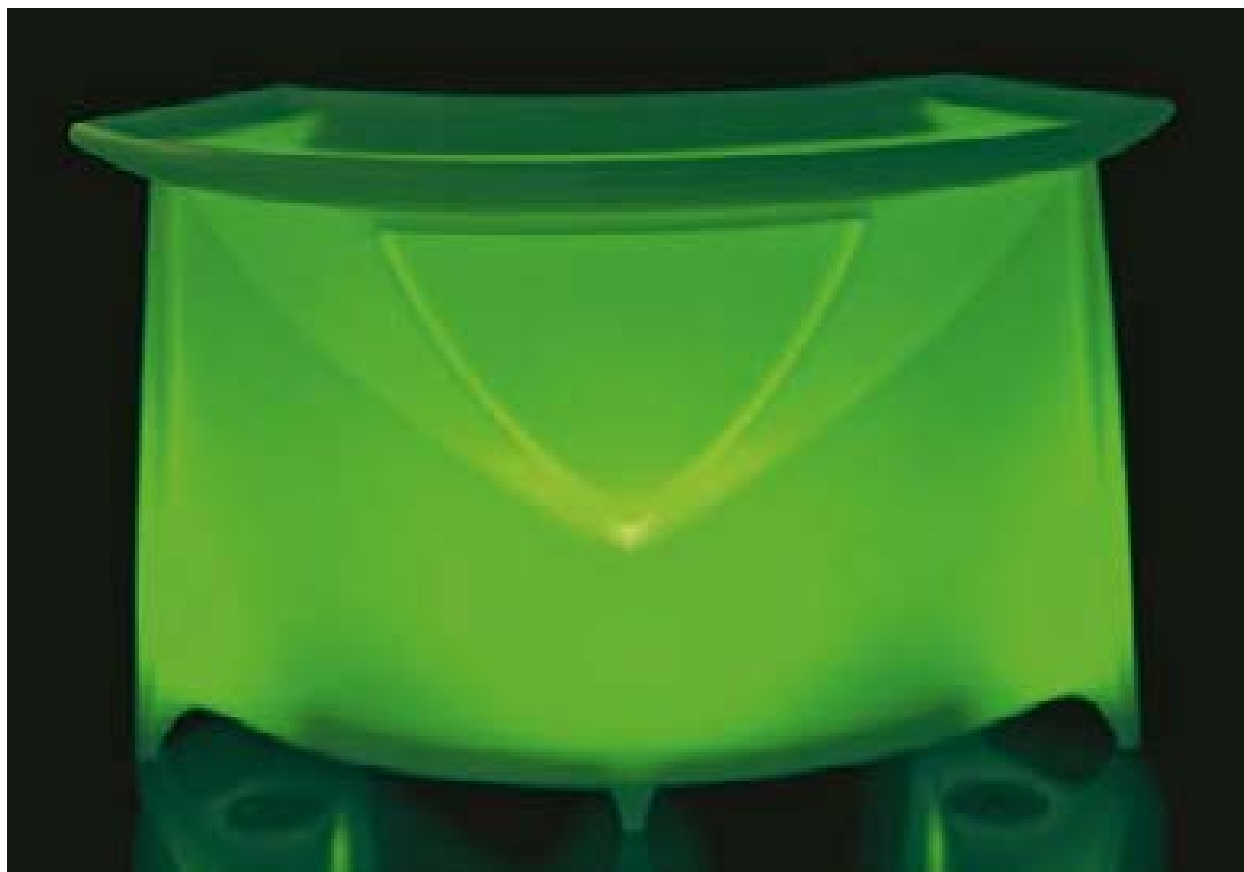



2029 - BZCH5508L
Con RGB
With RGB
(L138 x P70 x H106 cm)

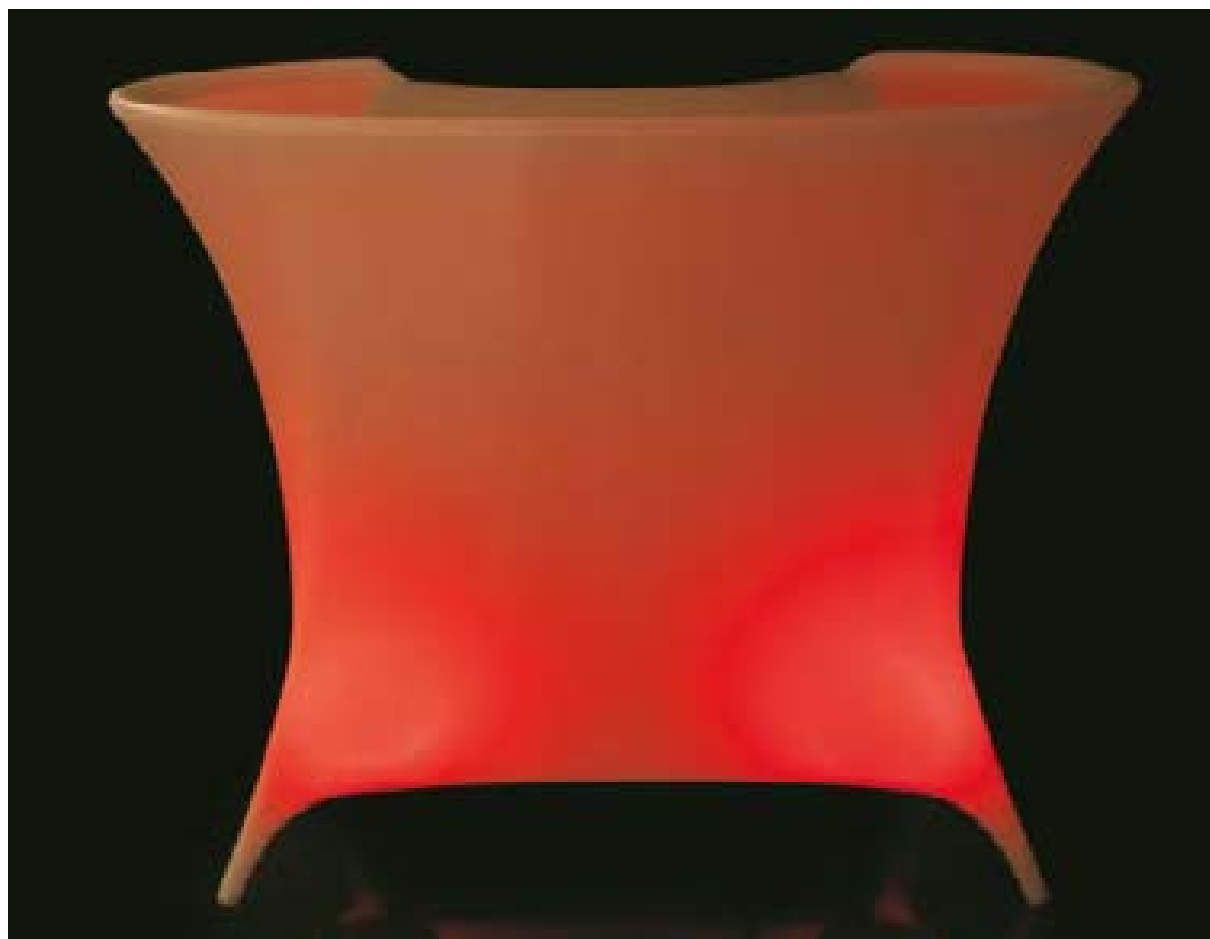



2041 - M447
Con RGB/With RGB
(L70 x P102 x H109 cm)



2040 - M446
Con RGB/With RGB
(L70 x P70 x H109 cm)





**Arredi
luminosi**

***Light
furniture***

AR



AR[®] ROSSANESE

Via Manara, 2
20812 Limbiate (Monza Brianza) - Italy
Tel. +39 029105427 - Fax +39 029182724
E-mail: info@rossanese.it - www.rossanese.it

