

The Tablecraft logo is a red oval with the word "TABLECRAFT" in white, uppercase, sans-serif font. There are two horizontal lines below the text.

TABLECRAFT

Providing Solutions for over 75 Years
Every Ware. Every Day.

2024 PRODUCT CATALOGUE

Customer Service
+44 1536 400091
salesuk@tablecraft.com



THE TABLECRAFT LEGACY

As a company, TableCraft is focused on the trends and needs of our industry to develop relevant products.

As a partner, TableCraft is focused on providing meaningful solutions that will enhance the operator's experience.

As a family business over 4 generations, TableCraft is focused on fostering strong, long-lasting relationships by serving our customers.

Thank you for all your support through the years and for the many more years to come!

ICONOGRAPHY:



Oven Safe



Induction Ready



Microwave Safe



Dishwasher Safe



Hand Wash Only



Temperature Safe Range



Cash & Carry Select Items



BPA Free



Listed Items



Scan to explore the new eu.tablecraft.com



European Headquarters
27 Causeway Road, Corby
Northants. NN17 4DU

Customer Service: 01536 400091
salesuk@tablecraft.com

eu.tablecraft.com

1 EA 12148



7 27875 27750 3

©2024 TPC, Inc.



2024 CATALOGUE TABLE OF CONTENTS

BUFFET, CATERING & DISPLAY | 02

BEVERAGE & COUNTER | 40

BAR SOLUTIONS | 52

TABLETOP SOLUTIONS | 74

SERVING SOLUTIONS | 86

DINING ROOM SOLUTIONS | 108

SQUEEZE BOTTLE | 114

KITCHEN TOOLS & FOOD PREP | 126

CARE & USE | 158

TERMS & CONDITIONS | 160

WORLDWIDE SALES | 161

INDEX | 162

ADD ELEVATION TO YOUR PRESENTATION

TableCraft offers an array of products that elevate your food presentation, enhance your buffet line and deliver dependable, durable solutions.



DISPLAY SOLUTIONS | 4

Universal Adapter Bars4
 Cooling Plates & Displays4
 Gastronorm Pans5

CHAFER AND COOKWARE | 6

Quick View (Fuel) Chafers.....6-7
 Food Pans for Chafers8-9
 Tri-Ply Cookware10
 Die Cast Cookware.....11
 Cast Iron Cookware & Servers12-13

CRATES, RISERS & DISPLAYS | 14

Gastronorm Display & Serving Crates.....14-15
 Crate Risers.....15
 Tiered Risers16
 Grab & Go Risers17
 Folding Crate Risers.....17
 Two-Tiered Crate Frame Risers18
 Lazy Susan Rotating Displays.....19
 Forge Collection™20-21
 Tiered and Storage Baskets22
 Grand Master™ Collection23
 Fruit Baskets.....23
 Cereal Dispensers23

RISERS AND DISPLAYS | 24

Cascade Risers™24
 Barclay Risers™24
 Non-Slip Risers.....25
 Nesting Risers25
 Fold-A-Way.....26-27

CAKE STANDS, DOMES, & COVERS | 28

Acacia Collection™ Cake Stands.....28
 Plastic Cake Plates & Domes.....29
 Cake Sets, Stands & Covers.....30
 Half & Full Size Covers.....31

ACCESSORIES & UTENSILS | 32

High Heat Utensils.....32
 Spoon Rests32
 Silicone & Stainless Steel Utensils.....33
 Antimicrobial™ Serving Ladles.....33
 Holden Collection™34-35

ACCESSORIES & DISPOSABLES | 36

Bamboo Picks.....36-37
 Disposable Cones, Cups & Boats38
 Disposable Cone Holders.....39
 Card Holders39



11794 Two-Tiered Riser Frame with:
 (2 ea) CRATE12W Half Size Crate
 (1 ea) CRATE11W Full Size Crate
 Crates sold separately (Food pan not included)

KEEPING IT COOL

Keep food perfectly chilled for up to 3 hours with this versatile solution. Our cooling plates are available in three sizes (Half, Half Long and Full). Use them separately or on stands. For best results, pre-chill cooling plates and cast aluminum bowls and trays in the freezer for 8-12 hours prior to use.



Full Size Cooling Plate shown on Individual Tiered Crate Frame (11448) See page 16 for more details.

UNIVERSAL ADAPTER BARS

- For use with cast aluminium pans in cold or hot well applications
- Use for dividing pans or filling gaps

| Item # | Description | Min Order/ Case Pack |
|--|---|----------------------|
| ADAPTER BARS – STAINLESS STEEL, MIRROR FINISH | | |
| d. | CWA12 33cm Bar, fits 1/2 Gastronorm Pan | 1 ea / 12 ea |
| e. | CWA20 53.5cm Bar, fits 1/1 Gastronorm Pan | 1 ea / 12 ea |



COOLING PLATES AND DISPLAYS



| Item # | Description | Min Order/ Case Pack |
|---|---|----------------------|
| COOLING PLATES – STAINLESS STEEL, BRUSHED FINISH | | |
| a. | CW60100 Full Size, 53 x 32.5 x 4.5cm | 1 ea / 4 ea |
| b. | CW60101 Half Size, 32.5 x 26.5 x 4.5cm | 1 ea / 6 ea |
| c. | CW60103 Half Long Size, 53 x 16 x 4.5cm | 1 ea / 8 ea |

Low-profile for sleek presentations



Brushed finish resists smudges and finger prints and cleans up easily



Non-slip rubber feet keep plate in place and allow for easy pickup

GASTRONORM MELAMINE PANS

- Not microwave or oven safe
- Not to be kept under heat lamps

AVAILABLE IN 3 COLOURS



MIX OR MATCH... PRESENT AND SERVE.



| Item # | Description | Min Order/ Case Pack |
|--|--|-------------------------|
| GASTRONORM SIZE PANS - MELAMINE | | |
| a. | MG2420BK 2/4 GN Black Pan, 20mm Deep | 1 ea / 32 ea |
| | MG2420W 2/4 GN White Pan, 20mm Deep | 1 ea / 32 ea |
| | MG1120BK 1/1 GN Black Pan, 20mm Deep | 1 ea / 16 ea |
| | MG1120W 1/1 GN White Pan, 20mm Deep | 1 ea / 16 ea |
| | MG1165BK 1/1 GN Black Pan, 65mm Deep | 1 ea / 16 ea |
| b. | MG1165W 1/1 GN White Pan, 65mm Deep | 1 ea / 16 ea |
| | MG11100BK 1/1 GN Black Pan, 100mm Deep | 7 ea |
| | MG11100R 1/1 GN Red Pan, 100mm Deep | 7 ea |
| | MG11100W 1/1 GN White Pan, 100mm Deep | 7 ea |
| | MG1265BK 1/2 GN Black Pan, 65mm Deep | 1 ea / 16 ea |
| | MG1265W 1/2 GN White Pan, 65mm Deep | 1 ea / 16 ea |
| | MG12100BK 1/2 GN Black Pan, 100mm Deep | 14 ea |
| | MG12100R 1/2 GN Red Pan, 100mm Deep | 14 ea |
| | MG12100W 1/2 GN White Pan, 100mm Deep | 14 ea |
| | MG1365BK 1/3 GN Black Pan, 65mm Deep | 1 ea / 24 ea |
| | MG1365W 1/3 GN White Pan, 65mm Deep | 1 ea / 24 ea |
| | MG13100BK 1/3 GN Black Pan, 100mm Deep | 21 ea |
| c. | MG13100R 1/3 GN Red Pan, 100mm Deep | 21 ea |
| | MG13100W 1/3 GN White Pan, 100mm Deep | 21 ea |
| | MG1465BK 1/4 GN Black Pan, 65mm Deep | 1 ea / 32 ea |
| | MG1465W 1/4 GN White Pan, 65mm Deep | 1 ea / 32 ea |



CLEARLY, THE BEST WAY TO PRESENT YOUR POINT OF VIEW

QUICK-VIEW FUEL & INDUCTION CHAFERS

- Unique 'stop anywhere' hinge for ease of use, as well as noise reduction
- Available in three colours; mix and match stands and dishes (each sold separately) to create a unique look
- Steam vent offers reduced condensation



| Item # | Description | Capacity | Min Order/ Case Pack |
|---|--|----------|-------------------------|
| 1/1 GN STAINLESS STEEL OR PVD COATED STAINLESS STEEL, GLASS WINDOWS | | | |
| a. 10422 | 1/1 GN Chafer, Stainless Steel | 8 L | 1 ea |
| 10423 | 1/1 GN Chafer, Stainless Steel with Gold PVD Coating | 8 L | 1 ea |
| 10424 | 1/1 GN Chafer, Stainless Steel with Black PVD Coating | 8 L | 1 ea |
| b. 10425 | 1/1 GN Rectangular Frame, Stainless Steel | - | 1 ea |
| 10426 | 1/1 GN Rectangular Frame, Stainless Steel with Gold PVD Coating | - | 1 ea |
| 10427 | 1/1 GN Rectangular Frame, Stainless Steel with Black PVD Coating | - | 1 ea |
| 2/3 GN STAINLESS STEEL OR PVD COATED STAINLESS STEEL, GLASS WINDOWS | | | |
| c. 10428 | 2/3 GN Chafer, Stainless Steel | 5.7 L | 1 ea |
| d. 10429 | 2/3 GN Chafer, Stainless Steel with Gold PVD Coating | 5.7 L | 1 ea |
| 10430 | 2/3 GN Chafer, Stainless Steel with Black PVD Coating | 5.7 L | 1 ea |
| e. 10431 | 2/3 GN Square Frame, Stainless Steel | - | 1 ea |
| 10432 | 2/3 GN Square Frame, Stainless Steel with Gold PVD Coating | - | 1 ea |
| f. 10433 | 2/3 GN Square Frame, Stainless Steel with Black PVD Coating | - | 1 ea |
| ROUND - STAINLESS STEEL OR PVD COATED STAINLESS STEEL, GLASS WINDOWS | | | |
| g. 10434 | Round Chafer, Stainless Steel | 4 L | 1 ea |
| 10435 | Round Chafer, Stainless Steel with Gold PVD Coating | 4 L | 1 ea |
| 10436 | Round Chafer, Stainless Steel with Black PVD Coating | 4 L | 1 ea |
| h. 10437 | Round Frame, Stainless Steel | - | 1 ea |
| 10438 | Round Frame, Stainless Steel with Gold PVD Coating | - | 1 ea |
| 10439 | Round Frame, Stainless Steel with Black PVD Coating | - | 1 ea |
| CHAFER REPLACEMENT PART | | | |
| i. 11564 | Hydraulic Stop Anywhere Hinge for Chafers, Stainless Steel | - | 1 ea / 10 ea |



All dishes and stands sold separately



Steam pan included with every dish



Fuel & induction ready

All models are now available in polished Stainless Steel, Gold PVD Coated or Black PVD Coated



Glass window for quick view of contents



Steam vent

New claw shaped feet

CHAFERS & STANDS AVAILABLE TO MIX & MATCH IN THREE FINISHES



Stainless Steel

Gold

Black

Use without a frame for induction use



Hydraulic Stop Anywhere Hinge

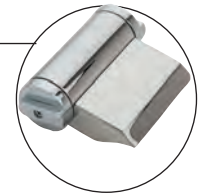



Unique divided food pan

| Item # | Description | Capacity | Min Order/ Case Pack |
|---|---|-----------|-------------------------|
| STAINLESS STEEL FOOD PANS WITH POLISHED FINISH | | | |
| a. | 11561 1/1 GN Food Pan, 54 x 34 x 6.5cm (fits 10422, 10423, 10424) | 8.5 L | 1 ea / 8 ea |
| b. | 11562 1/2 GN Food Pan, 32.5 x 26.5 x 6.5cm (fits 10422, 10423, 10424) | 3.8 L | 1 ea / 16 ea |
| c. | 11559 2/3 GN Food Pan, 36 x 32.5 x 6.5cm (fits 10428, 10429, 10430) | 5.7 L | 1 ea / 8 ea |
| d. | 11560 1/3 GN Food Pan, 32.5 x 6.5 x 6.5cm (fits 10428, 10429, 10430) | 2.6 L | 1 ea / 16 ea |
| e. | 11563 Round Food Pan, 38.5cm dia x 6.5cm (fits 10434, 10435, 10436) | 5.7 L | 1 ea / 8 ea |
| STAINLESS STEEL FOOD PAN WITH MATTE FINISH | | | |
| f. | CW40297 Round Divided, 39cm dia x 7cm (fits 10434, 10435 and 10436) | (2) 2.6 L | 1 ea / 6 ea |

THE INSIDE SCOOP ON OUR POLISHED FOOD PANS

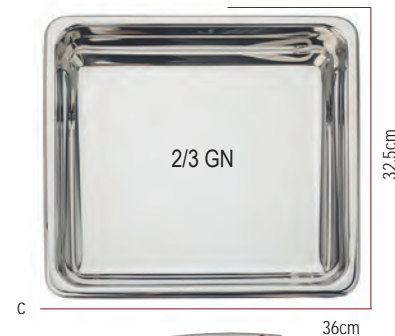

CHAFER FOOD PANS

Add a touch of class to Chafer service using these high-polish food pans.

- Each pan will fit in a variety of chafers

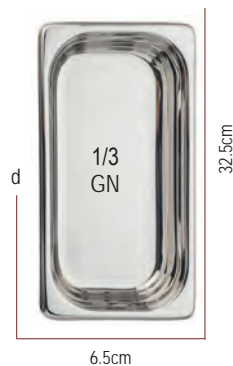

TRI-PLY COOKWARE TO TABLETOP

What does tri-ply mean?

- 18/8 Stainless Steel interior
- Aluminium core
- 18/0 Stainless Steel exterior
- Stainless Steel and Aluminium construction ensures even heat distribution



**HOT
HOLDING**
UP TO 230°C

PROFESSIONAL
BAKEWARE
BY
TABLECRAFT



a



b



c



d

Grill Pan and Wok both feature helper handles for better, more comfortable cooking control



h



i

Sauce Pot and Lid sold separately

NEW



j



f



e



g

Fits CW2034 Roast Pan

| Item # | Description | Capacity | Min Order/ Case Pack |
|--|--|----------|-------------------------|
| TRI-PLY COOKWARE – STAINLESS STEEL, ALUMINIUM | | | |
| a. | CW7010 Braiser with Handles, 25.5cm dia x 6.5cm | 3.4 L | 1 ea / 6 ea |
| b. | CW7012 Wok with 2 Handles, 24cm dia x 7.5cm | 3.4 L | 1 ea / 6 ea |
| c. | CW7020 Grill Pan with Helper Handle, 28cm dia x 4.5cm | 3.4 L | 1 ea / 4 ea |
| d. | CW7014 Wok with Helper Handle, 30cm dia x 8cm | 5.7 L | 1 ea / 4 ea |
| | CW2042 Oval Pan with 2 Handles, 36 x 24.5 x 12cm | 4.5 L | 1 ea / 6 ea |
| e. | CW2044 Oval Pan with 2 Handles, 47 x 27.5 x 11cm | 6.3 L | 1 ea / 4 ea |
| f. | CW2030 Roast Pan with 2 Handles, 33.5 x 24.5 x 11cm | 4 L | 1 ea / 6 ea |
| | CW2032* Roast Pan with 2 Handles, 41 x 29.5 x 11cm (Not Induction Ready) | 6.8 L | 1 ea / 4 ea |
| | CW2034* Roast Pan with 2 Handles, 46.5 x 34.5 x 13.5cm (Not Induction Ready) | 12.5 L | 1 ea / 2 ea |
| g. | CW2034L Roast Pan Lid, Fits CW2034 (Lid sold separately) | — | 1 ea / 4 ea |
| MINI-SAUCE POT & LID - STAINLESS STEEL, ALUMINIUM (SOLD SEPARATELY) | | | |
| h. | CW7000 Sauce Pot, 16cm dia x 6.5cm, 23cm dia with Handles | 950ml | 1 ea / 10 ea |
| i. | CW7000L Lid for CW7000, 16cm dia (Lid sold separately) | | 1 ea / 20 ea |
| j. | CW700LM Glass Lid for CW7000, 16cm dia (Lid sold separately) | | 1 ea / 20 ea |

* Induction ready unless otherwise noted.



DIE CAST COOKWARE

- Use on stove top hot plate, induction ready and oven-safe
- Exterior coating is designed for exposure to high temperatures
- Features a non-stick interior and strong cast handles



| Item # | Description | Capacity | Min Order/ Case Pack |
|---|---|----------|-------------------------|
| DIE CAST ALUMINIUM – STAINLESS STEEL | | | |
| a. | CWDC1030 Sauce Pan with Lid, 32 x 25.5 x 20.5cm | 5.7 L | 1 ea / 6 ea |
| b. | CWDC1070 Grill Pan, 45.5 x 27.5 x 5.5cm | - | 1 ea / 6 ea |
| c. | 10454 Grill Pan with Flat Plate, 45.5 x 27.5 x 5.5cm | - | 1 ea / 6 ea |
| d. | CWDC1040 Wok with Lid, 33cm dia x 19cm, 39.5cm dia with Handles | 3.4 L | 1 ea / 6 ea |
| e. | CWDC1050 Casserole with Lid, 32 x 25 x 16.5cm | 3.4 L | 1 ea / 6 ea |



c

CAST IRON COOKWARE

- Pre-seasoned, naturally non-stick & easy to clean
- Simple solution for cooking and serving from one dish
- Durable and dependable, a good option for extended use
- For more detailed care and use instructions see page 158
- Safe to -17°C



a

| Item # | Description | Capacity | Min Order/ Case Pack |
|------------------------------|---|----------|-------------------------|
| PLATTER, PANS AND WOK | | | |
| a. | CW30152 Fajita Platter, 19cm dia x 3.5cm, 26cm dia with Handles | 710ml | 1 ea / 6 ea |
| b. | CW30114 Square Pan, 27 x 27 x 5.5cm, 33cm dia with Handles | 2.6 L | 1 ea / 4 ea |
| c. | CW30116 Wok, 36.5 dia x 11.5cm, 44.5cm dia with Handles | 5.7 L | 1 ea / 4 ea |
| d. | CW30118 Pizza Pan, 34.5cm dia x 2cm, 44.5cm dia with Handles | — | 1 ea / 4 ea |
| OVAL AU GRATIN | | | |
| e. | CW30100 21.5 x 15.5 x 6.5cm, 27cm dia with Handles | 710ml | 1 ea / 6 ea |
| ROUND SKILLETS | | | |
| f. | CW30122 10cm dia x 3.5cm, with 9.5cm Handle | 90ml | 1 ea / 6 ea |
| g. | CW30124 14.5cm dia x 3cm, with 12cm Handle | 240ml | 1 ea / 6 ea |
| h. | CW30108 14cm dia x 4cm, with 9cm Handle | 355ml | 1 ea / 6 ea |

CAST IRON WORKS



d



b



e



f



g



h

CAST IRON COOKWARE



| Item # | Description | Capacity | Min Order/ Case Pack |
|---------------------------------------|--|----------|-------------------------|
| ROUND CASSEROLES WITH LID | | | |
| a. CW30110 | 10cm dia x 8.5cm, 13cm dia with Handles | 240ml | 1 ea / 4 ea |
| CW30148 | 13cm dia x 9.5cm, 18cm dia with Handles | 530ml | 1 ea / 6 ea |
| OVAL CASSEROLES WITH LID | | | |
| b. CW30112 | 12.5 x 9.5 x 8cm, 15.5cm dia with Handles | 240ml | 1 ea / 4 ea |
| ROUND SERVERS | | | |
| c. CW30102 | 12.5cm dia x 4cm, 16.5cm dia with Handles | 240ml | 1 ea / 6 ea |
| CW30104 | 13.5cm dia x 4.5cm, 18cm dia with Handles | 355ml | 1 ea / 6 ea |
| CW30142 | 15.8cm dia x 4cm, 20.5cm dia with Handles | 530ml | 1 ea / 6 ea |
| CW30140 | 18.4cm dia x 5cm, 23cm dia with Handles | 830ml | 1 ea / 6 ea |
| SQUARE SERVERS | | | |
| d. CW30150 | 12.5 x 12.5 x 4cm, 17.5cm width with Handles | 355ml | 1 ea / 6 ea |
| SIZZLE PLATTER | | | |
| e. 10746 | Oval, 23.5 x 17 x 1.5cm | — | 1 ea / 6 ea |
| f. 10764 | Oval Acacia Wood Underliner for Cast Iron Oval Skillet (10746) | — | 1 ea / 40 ea |
| KETTLE | | | |
| g. CW30151 | 13cm dia x 8cm | 475ml | 1 ea / 6 ea |
| FAJITA SERVING BOARDS – ACACIA | | | |
| h. 10709 | Rectangular, 47 x 22.5 x 2cm, Fits CW30100 or 10746 | — | 1 ea / 12 ea |
| i. 10710 | Oval, 43.5 x 31 x 2cm, Fits CW30100 or 10746 | — | 1 ea / 12 ea |

For more detailed care and use instructions see page 158 in back of book.





GASTRONORM DISPLAY CRATES



High quality designs that bring a rustic, yet contemporary, feel to your serving presentation

Handles for convenient transporting

Solid wood construction and reinforced corners



c

Designed to fit GN size food pans



d

| Item # | Description | Min Order/ Case Pack |
|---------------------------|--------------------------|-------------------------|
| WHITE PAINTED WOOD | | |
| a. CRATE11W | 1/1 GN Crate, 70mm Deep | 1 ea / 8 ea |
| CRATE12W | 1/2 GN Crate, 70mm Deep | 1 ea / 14 ea |
| b. CRATE13W | 1/3 GN Crate, 70mm Deep | 1 ea / 14 ea |
| CRATE14W | 1/4 GN Crate, 70mm Deep | 1 ea / 8 ea |
| ACACIA WOOD | | |
| CRATE11 | 1/1 GN Crate, 70mm Deep | 1 ea / 8 ea |
| CRATE114 | 1/1 GN Crate, 110mm Deep | 1 ea / 3 ea |
| CRATE116 | 1/1 GN Crate, 160mm Deep | 1 ea / 3 ea |
| CRATE12 | 1/2 GN Crate, 70mm Deep | 1 ea / 8 ea |
| c. CRATE124 | 1/2 GN Crate, 110mm Deep | 1 ea / 10 ea |
| CRATE126 | 1/2 GN Crate, 160mm Deep | 1 ea / 14 ea |
| CRATE13 | 1/3 GN Crate, 70mm Deep | 1 ea / 14 ea |
| CRATE134 | 1/3 GN Crate, 110mm Deep | 1 ea / 10 ea |
| CRATE136 | 1/3 GN Crate, 160mm Deep | 1 ea / 6 ea |
| CRATE14 | 1/4 GN Crate, 70mm Deep | 1 ea / 14 ea |
| BLACK PAINTED WOOD | | |
| d. CRATE11BK | 1/1 GN Crate, 70mm Deep | 1 ea / 8 ea |
| CRATE114BK | 1/1 GN Crate, 110mm Deep | 1 ea / 3 ea |
| CRATE12BK | 1/2 GN Crate, 70mm Deep | 1 ea / 8 ea |
| CRATE13BK | 1/3 GN Crate, 70mm Deep | 1 ea / 14 ea |

SERVICE WITH STYLE

GASTRONORM SERVING & DISPLAY CRATES



- These trays bring a refined rustic feel to your serving presentation
- Designed to fit standard full or half size food pans
- Features solid plank bottom and handles for convenient use
- Full size crate fits standard 30 x 45cm placemats

| Item # | Description | Min Order/ Case Pack |
|---------------------------|---|-------------------------|
| ACACIA WOOD | | |
| a. CRATESB11 | 1/1 GN Crate, Solid Base, 53 x 32.5 x 7cm | 1 ea / 8 ea |
| BLACK PAINTED WOOD | | |
| b. CRATESB11BK | 1/1 GN Crate, Solid Base, 53 x 32.5 x 7cm | 1 ea / 8 ea |



RISE TO ANY OCCASION

Our crate risers bring height and attraction to your displays. Crate styles feature one chalkboard panel for custom labelling and decorating. Crates also nest together for storage when not in use.

CRATE RISERS



| Item # | Description | Min Order/ Case Pack |
|--------------------------------------|---|-------------------------|
| NATURAL OR DISTRESSED FIRWOOD | | |
| c. *RCBCRATE1 | Natural Wood 3pc Set, Small 35 x 25.5 x 18cm, Medium 40.5 x 30 x 23.5cm, Large 49 x 34.5 x 26.5cm | 1 set |
| *RCBCRATE1SM | Natural Wood 2pc Set, Small 35 x 25.5 x 18cm, and Medium 40.5 x 30 x 23.5cm | 1 set |
| d. *RCBCRATE2 | Distressed Wood 3pc Set, Small 30.5 x 21 x 15.5cm, Medium 37 x 23 x 17.5cm, Large 42 x 30 x 19cm | 1 set |



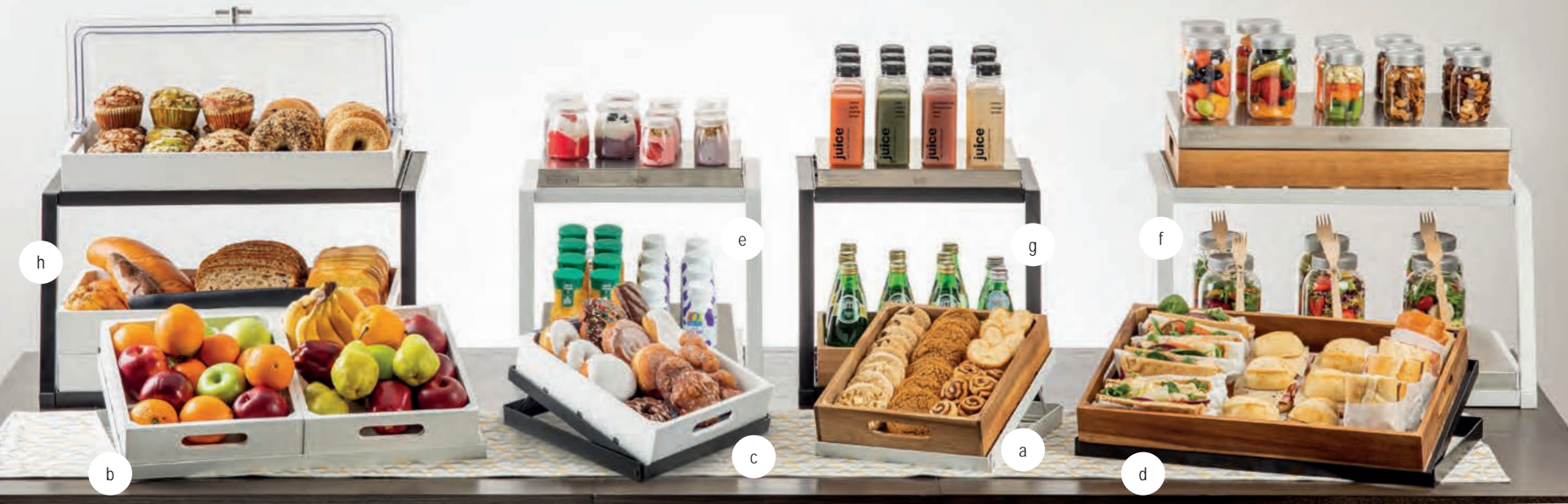

TIERED CRATE FRAMES

Display and merchandise your baked goods, fruit, or grab & go prepacked foods with these new frames now available in white that fit our full-size and half-size crates perfectly.

- Black or White Powder Coated Steel
- Collapsible design for display or storage
- See our collection of crates that pair with these frames



Shown with our 1/2 GN Black Painted Wooden Crate (CRATE12BK), see page 14.

NEW



View the benefits of our Tiered Crate Frames!



Collapse down to store flat



Works with our Half and Full Size Gastronorm Crates. Shown here with CRATE11, see pages 14-15 for our full assortment.

| Item # | Description | Min Order/ Case Pack |
|---|--|-------------------------|
| INDIVIDUAL TIERED FRAMES – WHITE POWDER COATED STEEL | | |
| a. 11797 ▶ | Fits GN 1/2 Wooden Crates 29 x 34 x 11.5cm | 1 ea / 6 ea |
| b. 11798 ▶ | Fits GN 1/1 Wooden Crates 55.5 x 34 x 11.5cm | 1 ea / 6 ea |
| GRAB & GO TWO TIERED FRAME – BLACK POWDER COATED STEEL | | |
| c. 11447 | Fits GN 1/2 Wooden Crates 29 x 34 x 11.5cm | 1 ea / 6 ea |
| d. 11448 | Fits GN 1/1 Wooden Crates 55.5 x 34 x 11.5cm | 1 ea / 6 ea |

GRAB & GO TWO-TIERED FRAMES

Display and merchandise your baked goods, fruits, or grab & go prepacked foods with these new frames that fit our 1/1 GN and 1/2 GN Crates, Cooling Plates and Melamine Platters.

- Black or White powder coated steel
- See our collection of crates that pair with these frames
- Ships flat; lock & channel design for quick, easy assembly



g

Works with our 1/2 GN and 1/1 GN Crates. Shown here with CRATE11 (top) and CRATE114 (bottom), see page 14 for our full assortment.

| Item # | Description | Min Order/ Case Pack |
|--|----------------------------------|-------------------------|
| GRAB & GO TWO TIERED FRAME, WHITE POWDER COATED STEEL | | |
| e. 11795 ▶ | 38.5 x 38.5 x 33cm (Fits GN 1/2) | 1 ea |
| f. 11796 ▶ | 59.5 x 45 x 33cm (Fits GN 1/1) | 1 ea |
| GRAB & GO TWO TIERED FRAME, BLACK POWDER COATED STEEL | | |
| g. 11622 | 38.5 x 38.5 x 33cm (Fits GN 1/2) | 1 ea |
| h. 11623 | 59.5 x 45 x 33cm (Fits GN 1/1) | 1 ea |

Works with our Half and Full Size Cooling Plates, shown here with CW60101, see page 32.



e

Keep products easily accessible with this space-efficient design.



Lip helps keep crates in place.



f

FOLDING CRATE STANDS



Perfect for room service, breakfast in bed or as a riser on your serving presentation. Our new folding crate stands work with our 1/1 GN Crates, Cooling Plates and 1/1 Melamine Platters.

- Available in both Acacia and Black Painted Rubberwood
- Integrated cutouts for easy handling while transporting stand and crate
- Do not submerge in water, wipe with a damp cloth and dry immediately
- 67.5 x 34 x 22cm (open) and 54.5 x 34 x 3cm (closed)
- Stackable for convenient storage
- Weight limit: 12kg



i

19cm clearance

| Item | Description | Min Order/ Case Pack |
|---|---|-------------------------|
| FOLDING CRATE STANDS (FITS GN 1/1) | | |
| i. 10765 | Folding Crate Stand, 67.5 x 34 x 22cm, Acacia | 1 ea / 4 ea |
| j. 10766 | Folding Crate Stand, 67.5 x 34 x 22cm, Black Painted Rubberwood | 1 ea / 4 ea |

HELPFUL HINT:

We do not recommend using folding crate stands to transport heavy items for display; position stand, add crate, and fill.



j

Legs stay in place when in use, collapse down to store flat

TAKING IT TO THE NEXT LEVEL

TWO-TIERED CRATE FRAME RISER

Perfect for breakfast buffets, grab-and-go stations or merchandising

Each tier of this riser display is designed to fit: (1 ea) 1/1 GN, (2 ea) 1/2 GN, (3 ea) 1/3 GN or (4 ea) 1/4 GN Size Wooden Crates featured on page 14, Wooden Crates sold separately

- Ships flat. Lock & channel design for quick, easy assembly



Removable chalkboard panel to customise presentation

Features adjustable shelves so you can display flat or on an angle



a

NEW



b

| Item # | Description | Min Order / Case Pack |
|---|-----------------------------|-----------------------|
| TWO-TIERED CRATE FRAME RISER – POWDER COATED STEEL, BLACK OR WHITE | | |
| a. 11000 | Black, 54.5 x 34.5 x 56.5cm | 1 ea |
| b. 11794 ▶ | White, 54.5 x 34.5 x 56.5cm | 1 ea |

Chalkboard sign can be removed for more space saving display options.



11000 Two-Tiered Riser Frame with:
(2 ea) CRATE12 1/1 GN Wooden Crate
(2 ea) CRATE124 1/2 GN Wooden Crate



11000 Two-Tiered Riser Frame with:
(1 ea) CRATE114BK 1/1 GN Wooden Crate
(1 ea) CRATE11BK 1/1 GN Wooden Crate
Crates sold separately (Food pan not included)



11000 Two-Tiered Riser Frame with:
(1 ea) CW60100 Full Size Cooling Plate
(1 ea) CRATE11W Full Size Crate
Crates sold separately (Food pan not included)



11794 Two-Tiered Riser Frame with:
(2 ea) CRATE12W 1/2 GN Wooden Crate
(1 ea) CRATE11W 1/1 GN Wooden Crate
Crates sold separately (Food pan not included)



LAZY SUSAN ROUND SERVER

Our new lazy susan offers a turntable solution to your tabletop, countertop, or buffet line. Display anything from bakery items, entrees, appetisers, or desserts while offering a solution to easily share dishes among diners or easily grab condiments from the center of the table.

- Acacia wood
- Available in 3 different sizes
- Hand wash only



Scan code to view a video on our Lazy Susan Round Servers.



a - c

| Item # | Description | Min Order/ Case Pack |
|---------------------------------|--------------------------------|-------------------------|
| LAZY SUSAN – ACACIA WOOD | | |
| a. 11828 ▶ | 33cm dia x 4cm rotating disc | 1 ea / 6 ea |
| b. 11829 ▶ | 38cm dia x 4.5cm rotating disc | 1 ea / 6 ea |
| c. 11830 ▶ | 45.5cm dia x 4cm rotating disc | 1 ea / 6 ea |

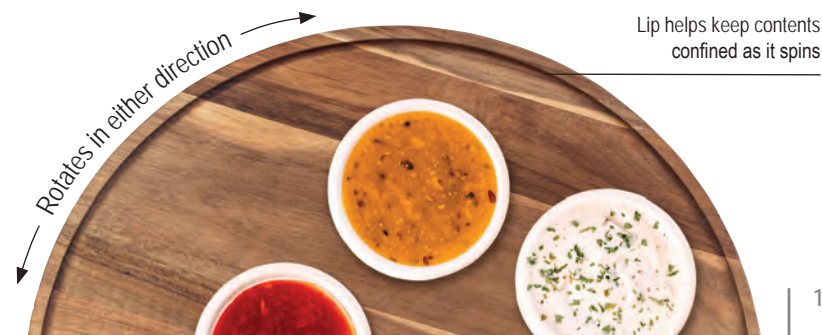



FORGE AHEAD

e

FORGE COLLECTION™ BASKETS



Perfect baskets for indoor and outdoor service that provide rustic style to your tabletop or buffet. They can also be used for grab & go service as well as placing a liner inside for tabletop service.

- Black Galvanized Steel
- Hand wash only

NEW

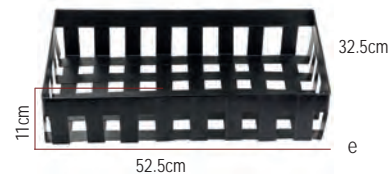
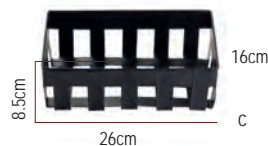
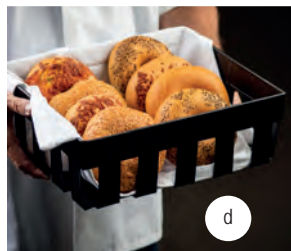
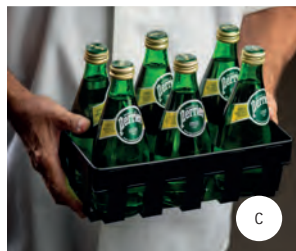

BUFFET & CATERING
FORGE COLLECTION™

| Item # | Description | Min Order/ Case Pack |
|---------------------------------------|---|-------------------------|
| GALVANIZED STEEL, BLACK COATED | | |
| a. 11692 ▶ | Round Basket, 20.5cm dia x 7cm | 1 ea / 36 ea |
| b. 11693 ▶ | Round Basket, 26cm dia x 10cm | 1 ea / 36 ea |
| c. 11694 ▶ | Rectangular Basket, 26 x 16 x 8.5cm (GN 1/3 size) | 1 ea / 36 ea |
| d. 11695 ▶ | Rectangular Basket, 32.5 x 26.5 x 11cm, fits 11622 Display (GN 1/2 size) | 1 ea / 6 ea |
| e. 11696 ▶ | Rectangular Basket, 52.5 x 32.5 x 11cm, fits 11623 and 11000 Displays (GN 1/1 size) | 1 ea / 6 ea |
| f. 11846 ▶ | Bottle Caddy, 18.5 x 18 x 17cm, holds (4) 63mm bottles | 1 ea / 18 ea |
| g. 11847 ▶ | Bottle Caddy, 23 x 18.5 x 17cm, holds (6) 63mm bottles | 1 ea / 12 ea |



Scan code to view a video on our Forge Collection™

BRIGHTEN
UP
BREAKFAST,
BRUNCH &
BEYOND

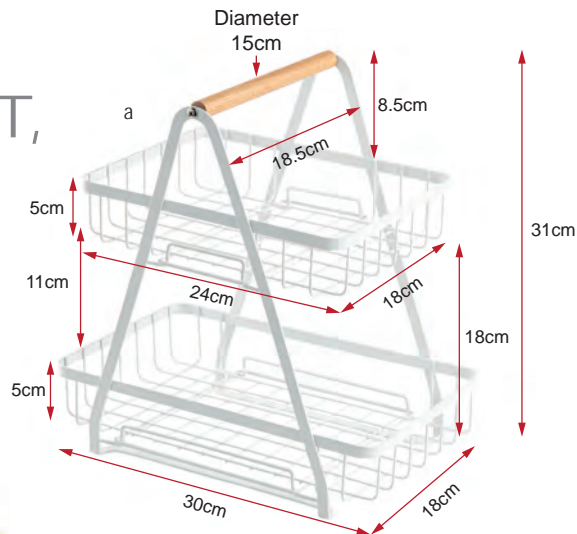

TWO-TIERED BASKET DISPLAY AND STORAGE BASKETS WITH WOODEN HANDLES



Create a brighter, lighter grab & go station for breakfast items, baked goods, fruits, every ware. every day.

- White Powder Coated Steel with Wooden Handles
- 2-Tier basket display requires minimal assembly

NEW

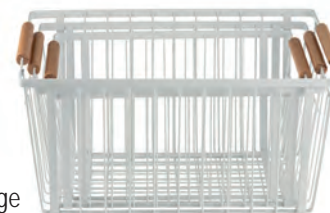

Scan code to
view a video on
our Baskets.

Storage baskets nest
together for compact storage

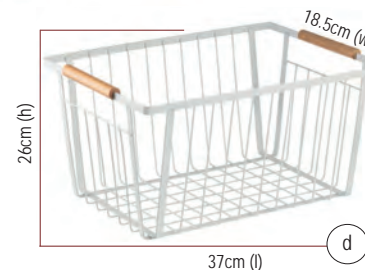
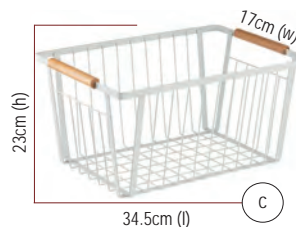
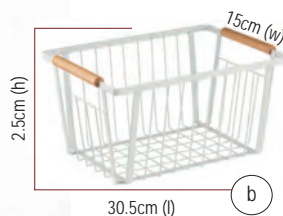

| Item # | Description | Min Order/ Case Pack |
|--|--|-------------------------|
| WHITE POWDER COATED METAL WITH WOODEN HANDLES | | |
| a. 11784 ▶ | 2-Tier Basket Display, White, 30 x 23 x 31cm (overall) Small Basket (top) 24 x 18 x 5cm, Large Basket (bottom) 30 x 18 x 5cm | 1 ea / 6 ea |
| b. 11785 ▶ | Storage Basket with Handles, White 30.5 x 20.5 x 15cm | 1 ea / 6 ea |
| c. 11786 ▶ | Storage Basket with Handles, White 34.5 x 23 x 17cm | 1 ea / 6 ea |
| d. 11787 ▶ | Storage Basket with Handles, White 37 x 26 x 18.5cm | 1 ea / 6 ea |

GRAND MASTER™ TRANSFORMER® COLLECTION



Versatile wire baskets can be filled as-is, with a cloth insert, melamine bowl and more. All baskets feature adjustable legs for versatile display height and angle options.

| Item # | Description | Min Order/ Case Pack |
|----------------------------------|--|-------------------------|
| BLACK POWDER COATED METAL | | |
| a. | GMT13105 Rectangular, 1/2 GN Size, 125mm Deep | 1 ea / 6 ea |
| b. | GMT21125 Rectangular, 1/1 GN Size, 125mm Deep | 1 ea / 6 ea |
| c. | GMT2412 Oblong, 61 x 30.5 x 15cm | 1 ea / 4 ea |
| | GM1212 Angled Square, 30.5 x 30.5cm, 6.5cm Front, 11.5cm Back | 1 ea / 4 ea |
| d. | GM1519 Angled Square, 38 x 49.5cm, 6.5cm Front, 20.5cm Back | 1 ea / 4 ea |
| | GM1608 Rectangular, 40.5 x 20.5 x 11cm | 1 ea / 4 ea |
| e. | GM2113 Rectangular, 53.5 x 33.5 x 13.5cm | 1 ea / 4 ea |

TRANSFORMS YOUR PLACE TO SAVE YOU SPACE



Raised up 1 level

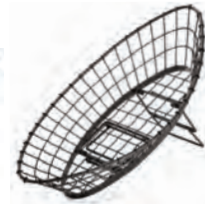

Angled up 2 levels



d



FRUIT & CEREAL DISPENSERS



Save space and keep fruit organised on your buffet line, while bringing a touch of the unusual to your healthy fruit display with these fun metal baskets. Suitable for all single-serve fruit; ideal for grab-and-go and for point of sale displays.

| Item # | Description | Min Order/ Case Pack |
|---|--|-------------------------|
| FRUIT BASKETS, CHROME PLATED WIRE | | |
| f. | FC1649 Curved Basket, 35.5 x 16 x 45.5cm (Maximum fruit diameter 10.5cm) | 1 / 12 ea |
| CEREAL DISPENSER, POLYCARBONATE, STAINLESS STEEL | | |
| g. | 693 3 Compartment Rotating Cereal Dispenser, ((3) 8.5 L capacity, 49.5 x 49.5 x 67.3cm) | 1 ea |

FRUIT BASKET



CEREAL DISPENSER





STEP IT UP

Display on or in risers
Mix or match sets



BARCLAY RISERS™



- Set of three risers nest together for easy storage

| Item # | Description | Min Order/ Case Pack |
|--|--|-------------------------|
| SQUARE-WOOD, BRUSHED STAINLESS STEEL OR BAMBOO | | |
| a. | WBK3 3-Pc Set, Black, Wood Set Includes: 12.5, 17.5 & 23cm | 1 set / 2 sets |
| b. | RS3 3-Pc Set, Brushed S/S Set Includes: 12.5, 17.5 & 23cm | 1 set / 2 sets |
| c. | WBAM3 3-Pc. Set, Bamboo Set Includes: 12.5, 17.5 & 23cm | 1 set / 2 sets |



CASCADE RISERS™



- Versatile and attractive buffet solution, can be nested together or fanned apart
- Set of 3: Small (44x18x11.5cm) Medium (48.5x18x15.5cm) Large (56x18x18cm)

| Item # | Description | Min Order/ Case Pack |
|--------|---------------------------|-------------------------|
| d. | RACA300 Acacia | 1 set |
| e. | RBAM300 Bamboo | 1 set |
| f. | RBK300 Black painted wood | 1 set |

SUPPORT SYSTEMS

Our riser collections can play a supporting role in any buffet line catering event or tablescape with ease and versatility.

NON-SLIP RISERS



15 x 15cm top plate
17.5 x 17.5cm footprint



| Item # | Description | Min Order/ Case Pack |
|--------------------------------------|--|-------------------------|
| CHROME PLATED OR BLACK POWDER COATED | | |
| a. CR3 | 3-Pc Set, Chrome Plated 15 x 15 x 5cm / 15 x 15 x 7.5cm / 15 x 15 x 10cm | 1 set / 8 sets |
| b. BKR4 | 4-Pc Set, Black 5cm H / 7.5cm H / 10cm H / 15cm H | 1 set / 6 sets |

NESTING RISERS



- Multi-purpose design—can be used as a base for a bowl or to elevate your dishes
- Set of three graduated-size risers nest together for easy storage



| Item # | Description | Min Order/ Case Pack |
|-------------------------|--|-------------------------|
| BRUSHED STAINLESS STEEL | | |
| c. RR3 | Set Includes: 20cm dia x 22.5cm H, 17.5cm dia x 15cm H, 15cm dia x 7.5cm H | 1 set / 2 sets |

POP-UPS



a

b

c

FOLD-A-WAY™ RISER SET



- A charming way to display a variety of different sized bowls and platters
- Collapsible design helps to save valuable storage space
- Features heat safe, non-slip grips and safely holds up to 15kg
- Available in three sizes : Small (19 x 19 x 18cm),
Medium (27 x 27 x 25cm)
Large (30 x 30 x 38cm)

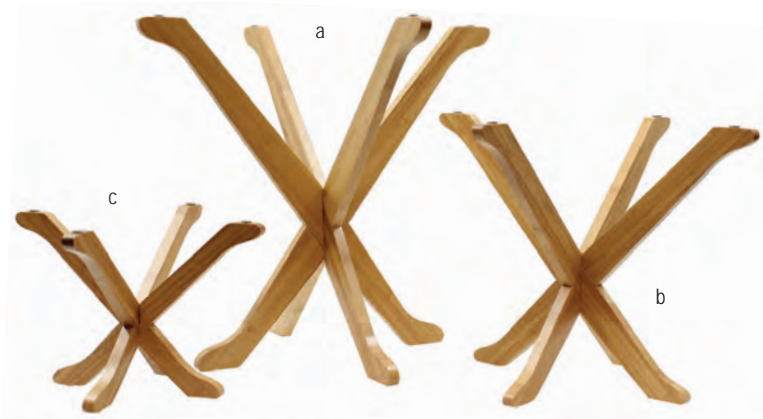

| Item # | Description | Min Order/ Case Pack |
|------------------------------------|-------------------------------------|-------------------------|
| FOLD-A-WAY™ RISERS – BAMBOO | | |
| a. RFTT3BAML | Large Bamboo Riser, 30 x 30 x 38cm | 1 ea / 12 ea |
| b. RFTT3BAMM | Medium Bamboo Riser, 27 x 27 x 25cm | 1 ea / 12 ea |
| c. RFTT3BAMS | Small Bamboo Riser, 19 x 19 x 18cm | 1 ea / 12 ea |
| FOLD-A-WAY™ RISERS – BLACK | | |
| d. RFTT3BKL | Large Black Riser, 30 x 30 x 38cm | 1 ea / 12 ea |
| e. RFTT3BKM | Medium Black Riser, 27 x 27 x 19cm | 1 ea / 12 ea |
| f. RFTT3BKS | Small Black Riser, 19 x 19 x 18cm | 1 ea / 12 ea |



ACACIA COLLECTION™ CAKE PLATE, STANDS & DOME



Upgrade your buffet or serving presentation with these new cake plates, stands and cake dome that fit perfectly into our Acacia Collection™. Natural Acacia wood provides warm, earthy texture. Perfect for dressing up your buffet or serving meat and cheese boards, appetisers, entrees and desserts.

- Acacia wood finish
- Cake dome made from acrylic with an acacia wood knob
- Do not submerge in water, wipe clean with a damp cloth and dry immediately.



| Item # | Description | Min Order/ Case Pack |
|--------|---|-------------------------|
| a. | 11440 Round Cake Plate, 31.5cm dia x 1.5cm | 1 ea / 12 ea |
| b. | 11441 Round Cake Stand, Un-assembled, 31.5cm dia x 15cm | 1 ea / 6 ea |
| c. | 11442 Round Cake Stand, Un-assembled, 31.5cm dia x 22.5cm | 1 ea / 6 ea |
| d. | 11443 Round Cake Dome, Clear Acrylic /Acacia Wooden Handle, 30cm dia x 14.5cm | 1 ea / 8 ea |
| e. | PCD1 Round Cake Dome, Clear, 30.5cm dia x 14.5cm | 1 ea / 6 ea |





NEW

PLASTIC (SAN) CAKE PLATE, STANDS & DOME



These new plastic cake plates, stands, and domes add style to your serving presentation. They are durable and clear so you can easily see your appetizer, dessert, bakery, or sandwich item being displayed.

- Made from BPA free plastic (SAN)
- Round and rectangular options available
- Easy to clean, dishwasher safe

| Item # | Description | Min Order/ Case Pack |
|--------|---|-------------------------|
| a. | 11884 ► Round Cake Dome, Clear, 30cm dia x 22cm | 1 ea / 6 ea |
| b. | 11885 ► Round Cake Stand, Clear, 32.5cm dia x 13.5cm | 1 ea / 2 ea |
| c. | 11886 ► Rectangular Cake Plate, Clear, 37.5x 18.5 x 3cm | 1 ea / 12 ea |
| d. | 11887 ► Rectangular Cake Cover, Clear, 34.5 x 15 x 19.5cm | 1 ea / 2 ea |



WE'VE
GOT YOU
COVERED



a (2-piece set)



b (2-piece set)



e



f



g



h

CAKE SETS STANDS & COVERS

- Stainless Steel stands and cake plates
- Polystyrene covers



| Item # | Description | Min Order/ Case Pack |
|-------------------------------|--|-------------------------|
| CAKE SETS | | |
| a. | 821422 Cake Stand / Cover Set, 32.5 x 35cm H | 1 ea |
| b. | *H820P422 Cake Plate / Cover Set, 33 x 20.5cm H | 1 ea |
| STANDS & COVERS | | |
| c. | 422 Metal Handle Cover, 30.5cm dia x 19cm H | 6 ea |
| d. | H820P Low Profile Cake Plate, 33cm dia x 3cm H | 1 ea / 12 ea |
| e. | 421 Polystyrene Cover with Handle, 30.5cm dia x 19cm H | 6 ea |
| | 821U Unassembled Stand, 32.5cm dia x 7.5cm H | 1 ea / 6 ea |
| CAKE DOME, SAN PLASTIC | | |
| f. | PCD1 Cake Dome, 30.5cm dia x 14.5cm H | 1 ea / 6 ea |
| g. | PCD2 Cake Dome, Square Edge, 31cm dia. 11.5cm Height | 1 ea / 3 ea |
| h. | 11519 Round Cake Dome Clear, SAN Plastic 28cm dia x 15.5cm | 1 ea / 6 ea |

HALF SIZE AND RECTANGULAR COVER

DISPLAY FOR TRAYS & CRATES

Dome displays keep your food covered and fresh on the serving line. Half Size Cover fits our Frostone Collection™ Black Slate Tray (MG2EU). Rectangular Full Size Cover can be use with our 1/1 GN crates.



- Keep your food covered and fresh on the serving line
- Coordinating crates and trays sold separately
- Made of polycarbonate plastic



b

Tray for reference only



Half Size Cover shown with Frostone Collection™ Black Slate Tray (MG2EU) see page M24, sold separately

BUFFET & CATERING
CAKE STANDS, COVERS & DOMES

| Item # | Description | Min Order/ Case Pack |
|----------------------|---|-------------------------|
| POLYCARBONATE | | |
| a. 11688 ▶ | Rectangular Half Size Cover, 33.5 x 27.5 x 19cm | 1 ea |
| b. PC1 | Rectangular Full Size Cover, 54.5 x 33.5 x 19cm | 1 ea |



Easy rollout cover with lip to keep it in place while serving and displaying.

HIGH HEAT UTENSILS

Upgrade your kitchen tools with these NSF certified high heat tools. Never leave a scratch or mark with these non-abrasive silicone tools.

- Heat resistant up to 204°C
- One-piece construction, odour and stain resistant
- Conveniently packaged for Cash & Carry



NEW



| Item # | Description | Min Order/ Case Pack |
|--------|-------------|-------------------------|
|--------|-------------|-------------------------|

HIGH HEAT TOOLS – SILICONE OVER NYLON, GREY

| | | |
|----|--|-------------|
| a. | 11834 ▶ Wide Spatula Spurtle, 7.5 x 2 x 32cm | 1 ea / 6 ea |
| b. | 11835 ▶ Narrow Spatula Spurtle, 5 x 2 x 33cm | 1 ea / 6 ea |
| c. | 11836 ▶ Wide Slotted Spatula Spurtle, 7.5 x 2 x 26.5cm | 1 ea / 6 ea |
| d. | 11837 ▶ Angled Spatula Spurtle, 5.5 x 2 x 26.5cm | 1 ea / 6 ea |
| e. | 11838 ▶ Slotted Spurtle, 5 x 2 x 26.5cm | 1 ea / 6 ea |
| f. | 11839 ▶ Solid Spurtle, 5 x 1.5 x 22cm | 1 ea / 6 ea |
| g. | 11840 ▶ Narrow Spatula Spurtle, 2.5 x 1.5 x 22cm | 1 ea / 6 ea |
| h. | 11841 ▶ Small Basting Brush, 3.5 x 1.5 x 21cm | 1 ea / 6 ea |
| i. | 11842 ▶ Large Basting Brush, 4.5 x 1.5 x 27.5cm | 1 ea / 6 ea |
| j. | H3900GY 150ml Ladle, 8.5 x 6.5 x 27.5cm | 1 ea / 6 ea |
| k. | H3902GY Spoon, 8.5 x 3 x 29cm | 1 ea / 6 ea |
| l. | H3903GY Perforated Spoon, 10 x 2.5 x 34.5cm | 1 ea / 6 ea |
| m. | H3905GY Slotted Turner, 8 x 3.5 x 30.5cm | 1 ea / 6 ea |
| n. | H3909GY Spatula, 5.5 x 1.5 x 26cm | 1 ea / 6 ea |
| o. | H3910GY Spatula Spoon, 6 x 1.5 x 26cm | 1 ea / 6 ea |



SPOON REST

| Item # | Description | Min Order/ Case Pack |
|------------------------|--|-------------------------|
| STAINLESS STEEL | | |
| HB1 | Single Spoon Rest, Brushed Finish, 20.5 x 10 x 4cm | 12 ea / 12 ea |



SILICONE & STAINLESS STEEL UTENSILS

- Stainless Steel core with silicone exterior construction provides a durable, flexible and scratch-resistant serving option
- Heat safe up to 204°C

| Item # | Description | Capacity | Min Order/ Case Pack |
|---------------------------------------|--|----------|-------------------------|
| SILICONE & STAINLESS STEEL | | | |
| a. | 39100 Tongs, 18 x 11.5 x 4.5 cm | - | 1 ea / 6 ea |
| b. | 39101 Tong, 22 x 11.5 x 4 cm | - | 1 ea / 6 ea |
| c. | 39102 Tongs, 16.5 x 4.5 x 30.5 cm | - | 1 ea / 6 ea |
| d. | 10050 Serving Ladle, 5.5 x 5 x 29 cm | 30ml | 1 ea / 6 ea |
| e. | 10051 Serving Ladle, 6.5 x 6 x 29.5 cm | 60ml | 1 ea / 6 ea |
| f. | 10052 Serving Ladle, 8 x 8 x 31 cm | 118ml | 1 ea / 6 ea |
| g. | 10053 Fish Turner, 8 x 2 x 35 cm | - | 1 ea / 6 ea |
| h. | 10054 Slotted Spatula, 8 x 6 x 33 cm | - | 1 ea / 6 ea |
| i. | 10055 Solid Spatula, 8 x 6 x 33 cm | - | 1 ea / 6 ea |

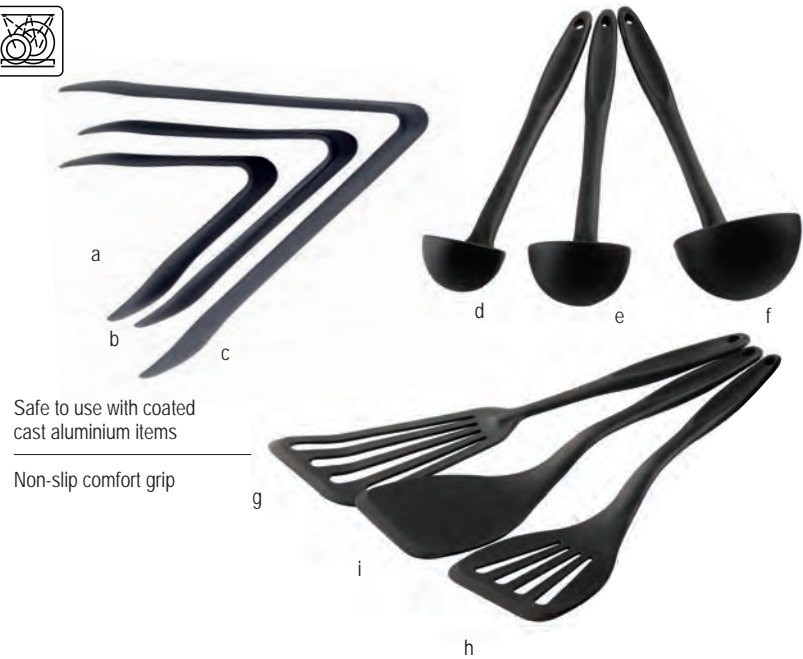

Safe to use with coated cast aluminium items

Non-slip comfort grip

BUFFET & CATERING
HIGH HEAT, SILICONE & ANTIMICROBIAL UTENSILS

ANTIMICROBIAL™ SERVING LADLES



Antimicrobial-infused vinyl handles provide protection against contamination from human contact and food residues. It is safe for food contact and will not wash or wear away from use or cleaning. This antimicrobial formula is USA Environmental Protection Agency (EPA) registered and EU Biocidal Products Regulation (BPR) certified.

| Item # | Description | Capacity | Min Order |
|---|------------------------------|----------|-------------|
| ANTIMICROBIAL MEASURING LADLES – STAINLESS STEEL | | | |
| j. | AM5301BK 1oz Measuring Ladle | 30ml | 1 ea / 6 ea |
| k. | AM5302BK 2oz Measuring Ladle | 60ml | 1 ea / 6 ea |
| l. | AM5303BK 3oz Measuring Ladle | 90ml | 1 ea / 6 ea |
| m. | AM5304BK 4oz Measuring Ladle | 120ml | 1 ea / 6 ea |
| n. | AM5306BK 6oz Measuring Ladle | 180ml | 1 ea / 6 ea |

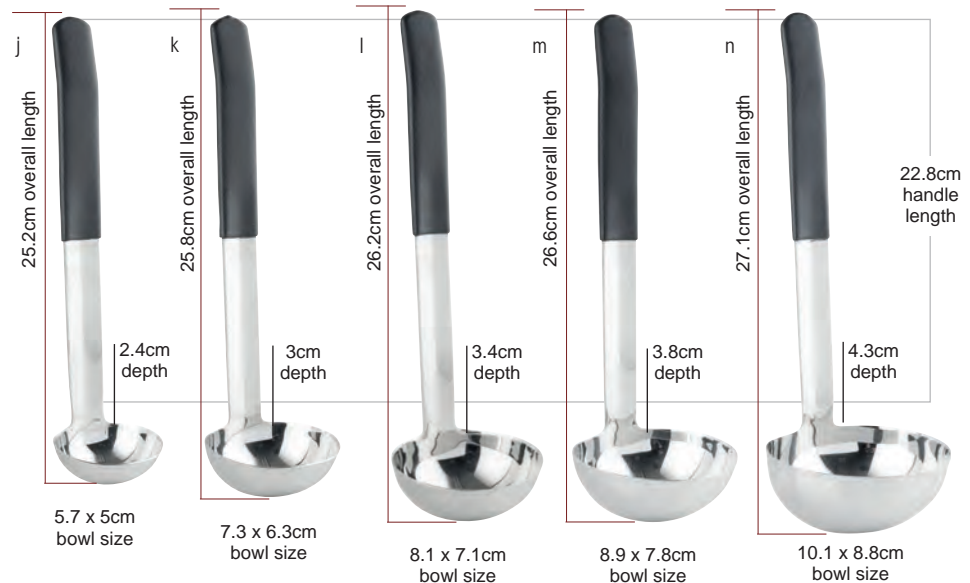

HOLDEN COLLECTION™ **NEW**

Our Holden Collection™ is ergonomically designed to achieve ideal balance, weight and feel required for serving. After service, these tools go right in the dishwasher, reducing cleanup time.

- Stylish and easy-to-use serving utensils for your buffet
- Features brushed finish handles and mirror finish heads for a unique serving presentation
- Utensils have a hollow handle with the exception of the tongs



Packaged for Cash & Carry

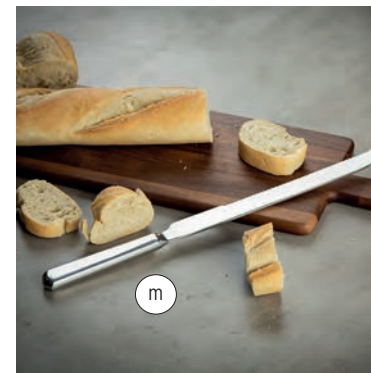

| Item | Description | Min Order/ Case Pack |
|--|--|-------------------------|
| HOLDEN COLLECTION™ UTENSILS – 18/0 OR *18/8 STAINLESS STEEL | | |
| a. | 11626 ▶ Solid Spoon, 30 x 6.5 x 3.5cm | 1 ea / 12 ea |
| b. | 11627 ▶ Slotted Spoon, 30 x 6.5 x 3.5cm | 1 ea / 12 ea |
| c. | 11628 ▶ Notched Spoon, 30 x 6.5 x 3.5cm | 1 ea / 12 ea |
| d. | 11629 ▶ Two-Tine Fork, 28.5 x 2 x 2.5cm | 1 ea / 12 ea |
| e. | 11630 ▶ Four-Tine Fork, 27.5 x 4.5 x 2cm | 1 ea / 12 ea |
| f. | 11631 ▶ 30ml Ladle with Spout, 30 x 9 x 5cm | 1 ea / 12 ea |
| g. | 11632 ▶ 60ml Ladle with Spout, 32 x 11 6.5cm | 1 ea / 12 ea |
| h. | 11633 ▶ 120ml Soup Ladle, 33 x 9 x 7.5cm | 1 ea / 12 ea |
| i. | 11634 ▶ Cake Server, 28 x 5.5 x 3cm | 1 ea / 12 ea |
| j. | 11635 ▶ Pie Server, 30.5 x 10 x 4.5cm | 1 ea / 12 ea |
| k. | 11636 ▶ Slotted Turner, 37.5 x 8.5 x 2cm | 1 ea / 12 ea |
| l. | 11637 ▶ Skimmer, 37.5 x 11 x 4.5cm | 1 ea / 12 ea |
| m. | 11638 ▶ Bread Knife, 35 x 2 x 1.5cm | 1 ea / 12 ea |
| n. | 11639 ▶ Steak Knife, 33 x 2 x 1.5cm | 1 ea / 12 ea |
| o. | 11640 ▶ Tong, 16 x 4.5 x 2cm (*18/8) | 1 ea / 12 ea |
| p. | 11641 ▶ Tong, 23 x 7 x 3.5cm (*18/8) | 1 ea / 12 ea |
| q. | 11642 ▶ Tong, 29 x 8.5 x 4.5cm (*18/8) | 1 ea / 12 ea |



A PERFECT BALANCE BETWEEN
VERSATILITY AND SIMPLE BEAUTY.

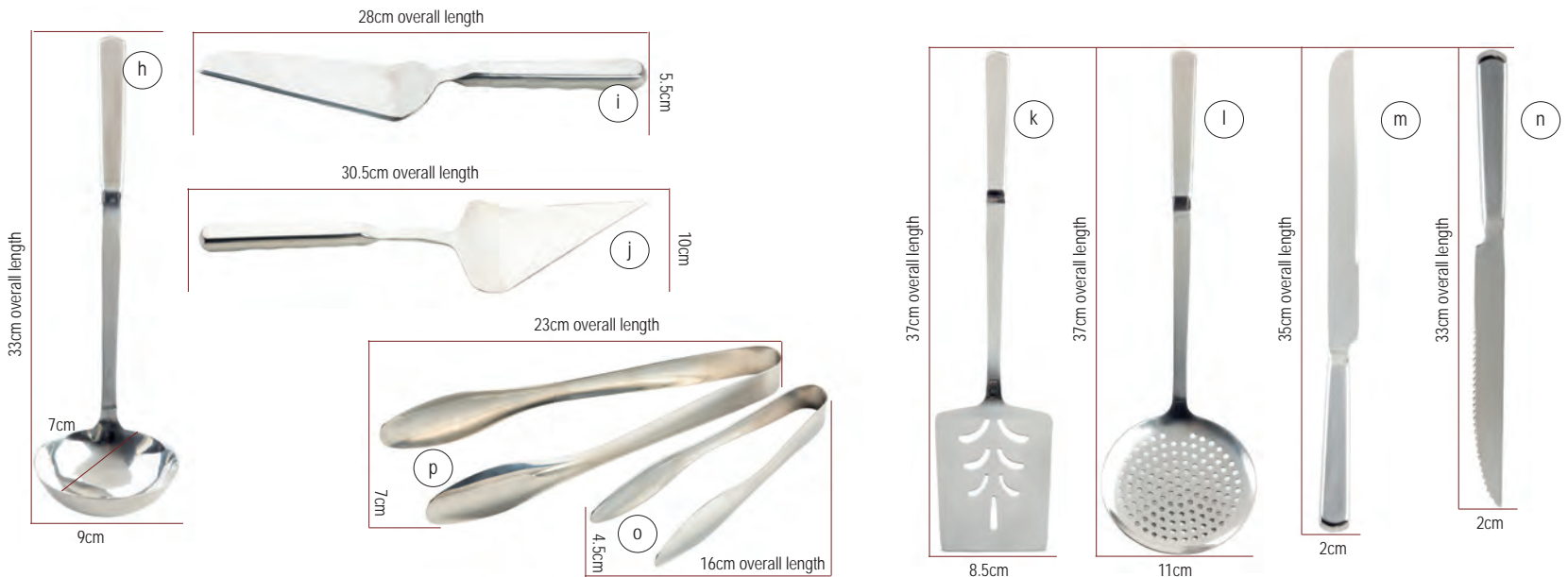

GO AHEAD... BE PICKY!

In fact, we encourage it. Whether it's for a special occasion or to help identify ham and swiss from turkey and provolone, our eco-friendly, disposable picks are a welcomed accessory to any buffet, banquet or catering function. For sanitary reasons, single use only.



BAMBOO PICKS

| Item # | Description | Min Order/ Case Pack |
|--|------------------------------------|-------------------------|
| FORK PICKS (100 PER POLYBAG) | | |
| a. BAMF35 | 9cm Fork Pick | 12 pk |
| CARD HOLDER PICKS (100 PER POLYBAG) | | |
| b. BAML35 | 9cm Card Holder | 12 pk |
| BAML7 | 17.5cm Card Holder | 12 pk |
| SPORTS PICKS (100 PER POLYBAG) | | |
| c. BAMSP145 | 11.5cm Baseball Sport | 12 pk |
| d. BAMSP245 | 11.5cm Basketball Sport | 12 pk |
| e. BAMSP345 | 11.5cm Golf Tees (Assorted Colors) | 12 pk |
| f. BAMSP545 | 11.5cm Football Sport | 12 pk |
| g. BAMSP645 | 11.5cm American Football Sport | 12 pk |

| Item # | Description | Min Order/ Case Pack |
|--|---------------------|-------------------------|
| KNOT PICK (100 PER POLYBAG) | | |
| h. BAMK35 | 9cm Knot | 12 pk |
| BAMK45 | 11.5cm Knot | 12 pk |
| BAMK7 | 18cm Knot | 12 pk |
| LOOPED & HEART LOOPED PICKS (100 PER POLYBAG) | | |
| i. BAML45 | 11.5cm Looped | 12 pk |
| j. BAMH45 | 11.5cm Heart Looped | 12 pk |
| BAMH6 | 15cm Heart Looped | 12 pk |
| CHALKBOARD PICKS (100 PER BOX) | | |
| k. BAMDCB35 | 9cm Chalkboard | 1 pk / 12 pk |



...ADD
SOME
FLARE



BAMBOO PICKS



| Item # | Description | Min Order/ Case Pack |
|---|---------------------------------------|-------------------------|
| PADDLE PICKS, STEAK MARKERS (100 PER POLYBAG) | | |
| a | RARE 9cm "Rare" Paddle Pick | 12 pk |
| b | MEDRARE 9cm "Medium Rare" Paddle Pick | 12 pk |
| c | MEDIUM 9cm "Medium" Paddle Pick | 12 pk |
| d | MEDWELL 9cm "Medium Well" Paddle Pick | 12 pk |
| e | WELLDONE 9cm "Well Done" Paddle Pick | 12 pk |
| FRENCH PADDLE PICKS, STEAK MARKERS (100 PER POLYBAG) | | |
| f | A POINT 9cm "A Point" Paddle Pick | 1 pk / 12 pk |
| g | BIEN CUIT 9cm "Bien Cuit" Paddle Pick | 1 pk / 12 pk |
| h | BLEU 9cm "Bleu" Paddle Pick | 1 pk / 12 pk |
| i | SAIGNANT 9cm "Saignant" Paddle Pick | 1 pk / 12 pk |
| VEGAN PADDLE PICKS (50 PER POLYBAG) | | |
| j | BAMP45VG 11.5cm Vegan Paddle Pick | 12 pk |

| Item # | Description | Min Order/ Case Pack |
|--|--------------------------------|-------------------------|
| SWORD PICKS (50 PER BOX) | | |
| k. | BAMPS45 11.5cm Sword Pick | 12 pk |
| | BAMPS6 15cm Sword Pick | 12 pk |
| PADDLE PICK (100 PER POLYBAG) | | |
| l. | BAMP35 9cm Paddle | 12 pk |
| | BAMP45 11.5cm Paddle | 12 pk |
| | BAMP7 18cm Paddle | 12 pk |
| PADDLE PICKS, ALLERGY & GLUTEN FREE (100 PER POLYBAG) | | |
| | BAMP35A 9cm Allergy Paddle | 12 pk |
| m. | BAMP45A 11.5cm Allergy Paddle | 12 pk |
| n. | BAMP35G 9cm Gluten-Free Paddle | 12 pk |
| | BAMP5G 13cm Gluten-Free Paddle | 12 pk |
| PURPLE PADDLE PICKS (100 PER POLYBAG) | | |
| o. | BAMP45PR 11.5cm Purple Paddle | 12 pk |

HOLDERS FROM CONES TO CARDS



DISPOSABLE CUPS, CONES AND BOATS

- A refreshing way to present appetisers, desserts and samples
- Easy to serve and comfortable for guests to hold



| Item # | Description | Capacity | Min Order/ Case Pack |
|-------------------------------------|---------------------------------|----------|-------------------------|
| CONES, PINEWOOD (50 PER BOX) | | | |
| BAMDCN5 | Mini, 5 x 5.5 x 12.5cm | 45ml | 12 pk |
| BAMDCN6 | Small, 6.5 x 7 x 15cm | 90ml | 12 pk |
| a. BAMDCN7 | Large, 7.5 x 9 x 18cm | 140ml | 12 pk |
| CUPS, PINEWOOD (50 PER BOX) | | | |
| BAMDCP2 | Small, 6cm dia x 6cm | 120ml | 12 pk |
| b. BAMDCP1 | Mini, 4.5cm dia x 4.5cm | 60ml | 12 pk |
| BOATS, PINEWOOD (50 PER BOX) | | | |
| c. BAMDB3 | Mini, 8.5 x 5.5 x 2.5cm | 30ml | 12 pk |
| BAMDB45 | Small, 11.5 x 6.5 x 3cm | 45ml | 12 pk |
| d. BAMDB5 | Medium, 13.5 x 8.5 x 4cm | 90ml | 12 pk |
| BAMDB65 | Large, 16.5 x 9 x 4cm | 150ml | 12 pk |
| BAMDB8 | Extra Large, 19.5 x 9.5 x 4.5cm | 235ml | 12 pk |



b

- Disposable
- Single-use
- Eco-friendly



c



a



d

DISPOSABLE CONE HOLDERS

- Display your disposable cones in style with our selection of tiered cone holders
- All styles include handles for easy transportation to and from the serving line



| Item | Description | Min Order/ Case Pack |
|----------|---|-------------------------|
| a. DCH27 | Chrome Plated Metal, Holds 27 Cones, 18.5cm dia x 42cm | 1 ea / 6 ea |
| b. DCH01 | Black Powder Coated Metal, Holds 1 Cone, 5.5 x 6.5 x 10 cm | 1 ea / 12 ea |



CARD HOLDERS



| Item # | Description | Min Order/ Case Pack |
|---|--|-------------------------|
| BLACK POWDER COATED METAL | | |
| c. | BKC2202 5cm dia, Stand with Clip | 1 ea / 12 ea |
| | BKC2206 5cm dia x 15cm, Stand with Clip | 1 ea / 12 ea |
| d. | BKC2208 5.5cm dia x 20.5cm, Stand with Clip | 1 ea / 12 ea |
| | BKC2212 5.5cm dia x 30.5cm, Stand with Clip | 1 ea / 12 ea |
| STAINLESS STEEL – PLASTIC | | |
| e. | CH2 5 x 5 x 9 cm, Circle Clip, Stainless Steel | 1 ea / 12 ea |
| f. | CH5 2.5 x 2.5 x 11.5cm, Cube with Clip, Clear Plastic | 1 ea / 12 ea |
| g. | CHX4 1 x 1.5 x 11.5cm, Double-sided Clip, Stainless Steel | 1 ea / 12 ea |
| STAINLESS STEEL | | |
| h. | 2504 5 x 5 x 10cm Harp Clip | 1 ea / 6 ea |
| | 2508 6.5 x 6.5 x 20cm Harp Clip | 1 ea / 6 ea |
| | 2512 7.5 x 7.5 x 30.5cm Harp Clip | 1 ea / 6 ea |
| i. | 797 2 x 2 x 4cm Harp Clip | 12 ea / 120 ea |
| HAMMERED TEXTURE STAINLESS STEEL | | |
| j. | 11575 5 x 5 x 3.5cm Card Holder, Stainless Steel | 1 ea / 24 ea |
| k. | 11576 5 x 5 x 3.5cm Card Holder, Gold PVD | 1 ea / 24 ea |
| l. | 11577 5 x 5 x 3.5cm Card Holder, Black Powder Coating | 1 ea / 24 ea |





REFRESHING BEVERAGE OPPORTUNITIES

TableCraft has a variety of solutions to fit your beverage dispensing needs. Our high quality dispensing options are designed to keep beverage stations organised and your operation moving.

COLD BEVERAGE DISPENSERS | 42

Upscale Beverage Dispensers 42
 Silhouette™ Beverage Dispensers..... 42
 Dual Beverage Dispensers..... 43
 Plastic Stackable Dispenser 43
 Slimline Beverage Dispensers..... 43
 Clear Glass Beverage Dispensers 44-45
 Glass Beverage Dispenser Stands..... 46
 Glass Beverage Dispenser Accessories..... 46
 Touchless Faucets..... 46

COLD BEVERAGE ACCESSORIES & TUBS | 47

Single Wall Beverage Tubs 47
 Bali Collection™ Beverage Tubs 47
 Remington Collection™ Beverage Tubs..... 47
 Brickhouse Collection™ Single Wall..... 47
 Double Wall Beverage Tubs 47

COLD BEVERAGE PITCHERS & ACCESSORIES | 48

Resealable Water Carafes 48
 Premium Water Servers 49
 Beverage Pitchers 49
 Tea Infuser..... 50
 Measuring Spoons..... 50
 Frothing Cups..... 51
 Bell Creamer..... 51
 Malt Cup 51
 Straw Dispensers 51



Port-A-Party: Beverage Tubs for Every Day Use, Every Where You Need Them. See page 35.



Scan code or go to our YouTube channel to watch our touchless faucet video

INFUSIBLES ARE UNREFUSABLE

More serving options and opportunities from chilled to flavored beverages in our Upscale, Silhouette™ and Stackable plastic beverage dispensers. Assorted styles available in multiple capacities for small to large groups.

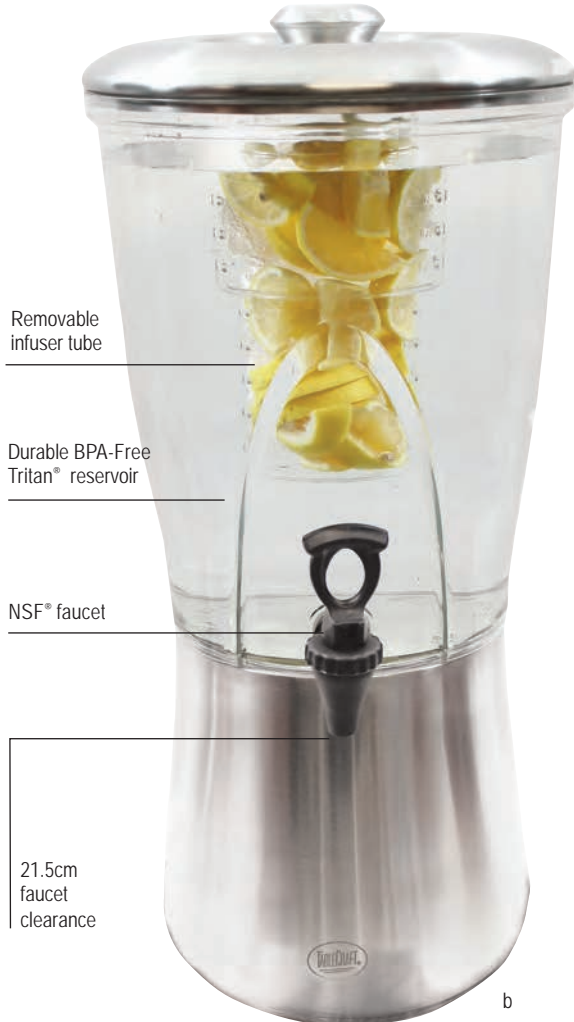

SILHOUETTE™
BEVERAGE DISPENSER

UPSCALE BEVERAGE DISPENSER



Hands free faucet option available (10626) see page 46



18.9 L capacity
Other capacities available

Durable BPA-Free Tritan® Reservoir

18cm faucet clearance on item 85

Removable infuser (75IC)



Removable ice core (75T)

Removable ice core tube fits into removable infuser

| Item # | Description | Capacity | Min Order/ Case Pack |
|---|---|----------|----------------------|
| UPSCALE BEVERAGE DISPENSERS—STAINLESS STEEL, BPA-FREE TRITAN® PLASTIC | | | |
| *75 | Upscale Beverage Dispenser, 17cm faucet clearance, 27.5 x 27.5 x 49.5cm | 11.4 L | 1 ea / 2 ea |
| a. *85 | Upscale Beverage Dispenser, 18cm faucet Clearance, 31 x 33.5 x 62cm | 18.9 L | 1 ea |
| SILHOUETTE™ BEVERAGE DISPENSERS –STAINLESS STEEL, BPA-FREE TRITAN® PLASTIC | | | |
| b. *N175 | NSF® Single, 21.5cm Faucet Clearance, 28.5 x 28.5 x 59.5cm | 13.2 L | 1 ea |
| REPLACEMENT PARTS & ACCESSORIES (MOST DISPENSERS) | | | |
| 75FM | Universal Stainless Steel Faucet, Fits 75, 85, 7515, BDG1000, BDG2000, BDG3000, 123494, 123495 and 123496 | - | 1 ea / 100 ea |
| BDGF | Chrome Plated ABS Faucet for BAD1500 and BDG Glass Beverage Dispensers | - | 1 ea / 120 ea |
| 75F | Heavy Duty Nickel Plated ABS Faucet for 75, 85 | - | 1 ea / 200 ea |
| N175F | NSF® Polypropylene Faucet for N175 | - | 1 ea / 200 ea |

DUAL BEVERAGE OPTIONS



a



b



c

DUAL

- Perfect addition to your breakfast buffet
- A simple way to offer a variety of drinks
- Includes a removable reservoir with built-in drainable ice chamber to keep drinks cool



STACKABLE*

- Stackable design, ideal solution for serving a variety of drinks on even a smaller serving station
- Compact and lightweight, perfect for smaller spaces
- Includes a removable infuser tube
- Sold individually



SLIMLINE BEVERAGE DISPENSER

- Detachable reservoirs and quality Tomlinson® faucets
- Simple to clean, easy to refill and quick to serve.
- Graduated measurements displayed on the side of reservoir for efficient and consistent filling.



e



d

| Item # | Description | Capacity | Min Order/ Case Pack |
|--|--|-----------|-------------------------|
| DUAL BEVERAGE DISPENSERS | | | |
| a. 70 | Double, 14cm faucet clearance, 30.5 x 35 x 58.5cm | (2) 5.7 L | 1 ea |
| PLASTIC STACKABLE BEVERAGE DISPENSERS | | | |
| b. *BAD1500 | BPA Free Dispenser with Infuser, 12cm faucet clearance, 24 x 24 x 34cm | 5.7 L | 1 ea / 4 ea |
| SLIMLINE BPA-FREE POLYPROPYLENE BEVERAGE DISPENSERS | | | |
| c. 353DP | Single, Black, 21cm faucet clearance, 20.5 x 41 x 52.5cm | 11.4 L | 1 ea |
| REPLACEMENT PARTS & ACCESSORIES | | | |
| d. 70F | Faucet for 70 | - | 1 ea |
| e. 852F | Heavy Duty Tomlinson® Faucet Assembly for 353DP | - | 1 ea / 100 ea |

The image shows two glass dispensers on a wooden surface. The dispenser on the left contains citrus slices and has a black circular tag hanging from its neck with the text 'Citrus Infused Water'. The dispenser on the right contains sliced cucumbers and has a similar tag with the text 'Chalkboard Necklace (BDCHBD)'. Both dispensers have a silver tap on the front. A white flower is visible in the foreground on the right.

Citrus
Infused
Water

Chalkboard
Necklace
(BDCHBD)

Choose from four styles; Beehive™, Rustic Country™, Mason Jar (2 sizes) and Industrial Collection™ — mix and match with our raised galvanized bases or a variety of wire bases to fit the style of your presentation (see page 46).

Each dispenser brings character and charm to your drink station.

All include a chalkboard necklace (BDCHBD - shown above) for labelling your drinks.

GET READY TO FILL, CHILL AND THRILL



a/d



b/e



c/f



g



h

BEVERAGE DISPENSERS *

CLEAR GLASS

| Item # | Description | Capacity | Min Order/ Case Pack |
|--|--|----------|-------------------------|
| CLEAR GLASS BEVERAGE DISPENSERS (ALL INCLUDE x1 CHALKBOARD NECKLACE – BDCHBD) | | | |
| a. | *BDG1000 Beehive™ with Chrome Plated Plastic Tap, Ice Core and Infuser, 23 x 27.5 x 37cm | 9.5 L | 1 ea |
| b. | *BDG2000 Rustic Country™ with Chrome Plated Plastic Tap, Resealable Lid, 21 x 26.5 x 35.5cm | 8.5 L | 1 ea |
| c. | *BDG3000 Mason Jar with Chrome Plated Plastic Tap, Ice Core and Infuser, 19.5 x 26 x 32cm | 8 L | 1 ea |
| d. | 123494 Beehive™ with Stainless Steel Tap, Ice Core and Infuser, 23 x 27.5 x 37cm | 9.5 L | 1 ea |
| e. | 123495 Rustic Country™ Resealable Lid with Stainless Steel Tap, 21 x 26.5 x 35.5cm | 8.5 L | 1 ea |
| f. | 123496 Mason Jar with Stainless Steel Tap, Ice Core and Infuser, 19.5 x 26 x 32cm | 8 L | 1 ea |
| g. | *10090 Industrial Collection™ with Chrome Plated Plastic Tap, Ice Core and Infuser, 20.5 x 25.5 x 32.5cm | 9 L | 1 ea |
| h. | *10360 Mini Mason Jar with Chrome Plated Plastic Tap, Ice Core and Infuser, 18 x 18 x 31cm | 5.5 L | 1 ea |
| REPLACEMENT FAUCETS | | | |
| i. | BDGF Faucet for BAD1500, BDG1000, BDG2000, and BDG3000, Chrome Plated Plastic | - | 1 ea |
| j. | 123497 Faucet for All Beverage Dispensers, Stainless Steel | - | 1 ea / 48 ea |



STAND AND DELIVER

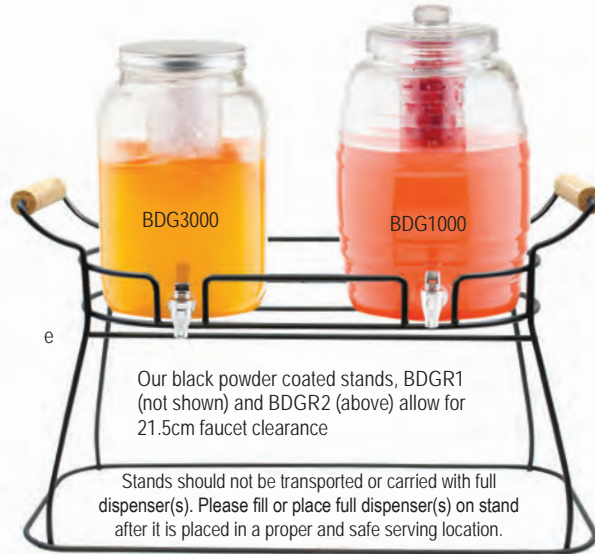

STANDS & ACCESSORIES

Elevate your beverage service! Our stands fit our range of Glass Beverage Dispensers and are available in many options to match with our existing buffet risers, crates and platters to create a consistent look on the serving presentation.

- Do not submerge in water, wipe with a damp cloth and dry immediately



Our black powder coated stands, BDGR1 (not shown) and BDGR2 (above) allow for 21.5cm faucet clearance

Stands should not be transported or carried with full dispenser(s). Please fill or place full dispenser(s) on stand after it is placed in a proper and safe serving location.

TOUCHLESS FAUCETS



- Our new touchless faucets provide sanitary, no contact dispensing to keep your employees, customers and operation safe and clean
- Simple, push designs are convenient, clean and easy to use
- Great for self-serve



| Faucet: | Fits Dispenser(s): |
|---------|---|
| 10626 | 75, BDG1000, BDG2000, BDG3000, 123494, 123495, 123496, 10360, BAD1500, 10090, 353DP & 356DP |
| 70F | 70 |

| Item # | Description | Min Order/ Case Pack |
|---|--|----------------------|
| ACCESSORIES & REPLACEMENTS PARTS | | |
| a. | BDCHBD Chalkboard Necklace Fits All Glass Beverage Dispensers, 10 x 0.1 x 7.5cm | 1 ea / 48 ea |
| b. | BDGF Faucet for BAD1500, BDG1000, BDG2000, & BDG3000, Chrome Plated Plastic | 1 ea / 120 ea |
| c. | BDGTUB Round Beverage Tub, Galvanised Steel, 24cm dia x 19.5cm | 1 ea / 6 ea |
| | BDGR1 Single Wire Beverage Dispenser Base, Black Powder Coated, (21.5cm faucet clearance) | 1 ea / 6 ea |
| d. | 10361 Beverage Stand for Mini Mason Jar 10360 Beverage Dispenser (21.5cm faucet clearance) | 1 ea / 6 ea |
| e. | BDGR2 Double Wire Beverage Dispenser Base, Black Powder Coated, (21.5cm faucet clearance) | 1 ea / 6 ea |
| f. | 10262 Industrial Collection™ Dispenser Base, Black Powder Coated, (Fits 10090 and BDG2000) | 1 ea |
| | 10173 Faucet for 10090, Black Plated Plastic | 1 ea / 120 ea |
| TOUCHLESS FAUCETS | | |
| g. | 10626 Universal Faucet, Black | 1 ea / 200 ea |
| h. | 70F Faucet with Chrome Plated Metal | 1 ea |

For full product dimensions see our website.



BEVERAGE TUBS SINGLE OR DOUBLE WALL

| Item # | Description | Capacity | Min Order/ Case Pack |
|---|---|----------|-------------------------|
| SINGLE WALL BEVERAGE TUBS – GALVANISED | | | |
| a. | BDGTUB Round, 24cm dia x 19.5cm | 5.5 L | 1 ea / 6 ea |
| b. | BT1914 Oval, 58 x 37 x 24cm | 21 L | 1 ea |
| c. | HBT1914 Oval, 58 x 37 x 24cm (bulk pack) | 21 L | 6 ea |
| d. | GT2313 Oval, Pebbled Texture, 58 x 31 x 19cm | 16.8 L | 1 ea |
| BEVERAGE TUBS – STAINLESS STEEL | | | |
| e. | Bali Collection™ Single Wall Oval Tub, 52 x 33.5 x 22cm | 15.1 L | 1 ea |
| f. | Remington Collection™ Double Wall Tub with Base, Rice Pattern, 42cm dia x 24cm | 28.4 L | 1 ea |
| BEVERAGE TUB SETS – STAINLESS STEEL | | | |
| g. | GTSS2313N Brickhouse Collection™ Set includes Tub, Stand, Accessory, Condensation Tray (Overall 70 x 38 x 81.5cm) | 48.3 L | 1 ea |
| h. | BT2137N Double Wall Tub Set includes & Black Powder Coat Stand, (Overall 51cm dia x 95.5cm) | 41.4 L | 1 ea |
| REPLACEMENT PARTS & ACCESSORIES | | | |
| GTSS2313 | Beverage Tub for GTSS2313N Set, 58 x 31 x 19cm | 48.3 L | 1 ea |
| GTSS2313CT | Condensation Tray for GTSS2313N Set, 60.5 x 32.5 x 5cm | - | 1 ea / 12 ea |
| GTSS2313AT | Accessory Tray for GTSS2313N Set, 63 x 32 x 5.5cm | - | 1 ea / 12 ea |
| GTSS2313S | Beverage Tub Stand for GTSS2313N Set, 59.5 x 32.5 x 57cm | - | 1 ea / 4 ea |



From single to double walled, and tabletop to floor standing, Our unique collection of beverage tubs are available in a variety of shapes, sizes and styles for any occasion.

REFRESH,
REUSE
AND
REPEAT



Silicone seal
and snap-lock
closures for safe
storage and
transport



RESEALABLE GLASS CARAFES

Upscale your beverage service again and again.



| Item # | Description | Capacity | Min Order/ Case Pack |
|---|--|----------|-------------------------|
| RESEALABLE WATER SERVERS - GLASS | | | |
| a. | *RSB33 Bottle with Silicone Seal, 8.5 x 8.5 x 32 cm | 1 L | 12 ea |
| b. | *RGC34 Bottle with Silicone Seal, 11 x 9 x 27cm | 1 L | 6 ea |



COLD BEVERAGE PITCHERS

| Item # | Description | Capacity | Min Order/ Case Pack |
|--|---|----------|-------------------------|
| PREMIUM WATER SERVERS – 18/8 STAINLESS STEEL, MIRROR FINISH | | | |
| a. 300 | Pitcher, Ice Guard, 22 x 12.5 x 21.5cm | 2 L | 1 ea / 12 ea |
| b. RP68 | Remington Collection™ Pitcher w/ Base, Ice Guard, Rice Pattern, 20.5 x 14.5 x 21.5 cm | 2 L | 1 ea / 12 ea |
| BEVERAGE PITCHERS – SAN PLASTIC, CLEAR | | | |
| c. 364 | Clear Pitcher, 18 x 12.5 x 20.5cm | 1.8 L | 1 ea / 12 ea |
| d. PP321 | Pitcher with Lid, 18 x 11.5 x 25 cm | 2 L | 1 ea / 12 ea |

PREMIUM SERVERS



Highly polished
Stainless Steel



c

BEVERAGE PITCHERS



BPA
FREE



Lid features
free flow and
ice guard

YOUR SPOT FOR TEA

TEA INFUSER

Our new stainless steel tea infuser is perfect for your morning or afternoon tea. It keeps all your loose-leaf tea inside the filter infusing your tea into your water. The bent handle is perfect to aid filling with loose tea leaves. Simple action allows zero contamination of tea leaves with hands.

- Stainless Steel construction
- Easy to clean, dishwasher safe



MEASURING SPOONS

Great for coffee service and precise portion control.

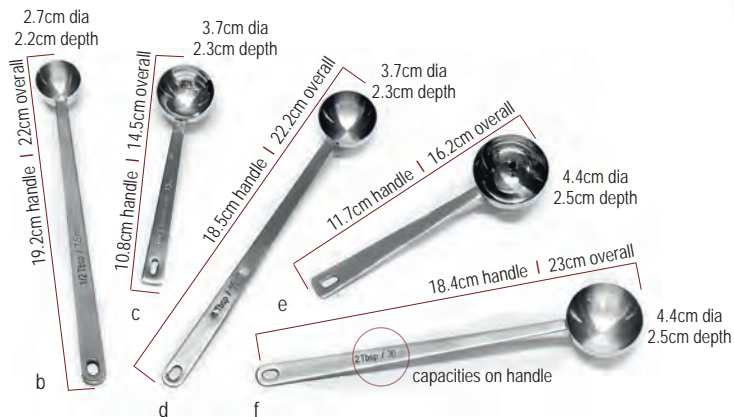

| Item # | Description | Capacity | Min Order/ Case Pack |
|---|---|----------|-------------------------|
| TEA INFUSER – (18-8) STAINLESS STEEL | | | |
| a. 11758 ▶ | Tea Infuser 15 x 2 x 2cm Stainless Steel for Loose Tea Leaves | - | 1 ea / 6 ea |
| MEASURING SPOONS – STAINLESS STEEL | | | |
| b. 40400 | ½ tbsp Long Handled Scoop, 22 x 2.5 x 2cm | 7.5 ml | 1 ea / 12 ea |
| c. 401 | 1 tbsp Scoop, 14.5 x 3.5 x 2cm | 15 ml | 1 ea / 12 ea |
| d. 40401 | 1 tbsp Long Handled Scoop, 22 x 3.5 x 2.5cm | 15 ml | 1 ea / 12 ea |
| e. 402 | 2 tbsp Scoop, 16 x 4.5 x 2.5cm | 30 ml | 1 ea / 12 ea |
| f. 40402 | 2 tbsp Long Handled Scoop, 23 x 4.5 x 2.5cm | 30 ml | 1 ea / 12 ea |

PREPARE AND PRESENT

FROTHING CUPS



Handled cups for your barista stand

Essential tool for frothing milk for lattes, cappuccinos, and more



BELL CREAMER



d

MALT CUP



- Great for malts and shakes
- Fits most standard mixers



e

STRAW DISPENSERS

- Stainless Steel and fluted glass options



f



g

| Item # | Description | Capacity | Min Order/ Case Pack |
|--|---|----------|-------------------------|
| FROTHING CUPS – STAINLESS STEEL | | | |
| a. | *2014 12-14oz Cup, 11 x 8 x 9cm | 415 ml | 1 ea / 12 ea |
| b. | 2024 20-24oz Cup, 14 x 8 x 10cm | 710 ml | 1 ea / 12 ea |
| c. | 2036 32-36oz Cup, 15 x 10.5 x 12.5cm | 1.1 L | 1 ea / 12 ea |
| BELL CREAMER – STAINLESS STEEL | | | |
| d. | 2303 Creamer, 8 x 4.5 x 6cm | 90ml | 1 ea / 12 ea |
| MALT CUP – STAINLESS STEEL | | | |
| e. | *64E Malt Cup 10.5cm dia x 18cm | 890 ml | 1 ea / 12 ea |
| STRAW DISPENSERS | | | |
| f. | 237 Two-Sided Straw Dispenser, Stainless Steel, 24.5 x 18 x 18.5cm (Holds up to 500 individually wrapped straws - not included) | | 1 ea / 8 ea |
| g. | *H714CH Glass Straw Dispenser, Chrome Plated Insert, 11cm dia x 28.5cm (Straws not included) | | 6 ea / 6 ea |



MEASURE, MIX & POUR

We offer professional, well-designed essentials for any bar or restaurant. From bartending tools, bar equipment and supplies, to providing wine service and bar accessories, TableCraft's products tend to the bar so you can tend to your customers.

BARTENDING TOOLS | 54

| | |
|--|----|
| Waverly Collection™ Mixing Glasses | 54 |
| PVD Barware Collections | 55 |
| Black Floral Finish Barware | 56 |
| Champagne Finish Barware | 57 |
| Premium Barware Collections | 58 |
| Premium Brushed Finish Barware | 59 |
| Pourmaster® One-Piece Neck/Spout | 60 |
| Pourmaster® Backups | 60 |
| Pourmaster® Series | 61 |
| Pourmaster® Completes | 61 |
| Measured Pourers | 62 |
| Proper Pour® III Measured Pourers | 62 |
| Free Flow Pourers | 62 |
| Whiskey Pourers | 62 |
| Economy Pourers | 62 |
| Screen Em™ Pourers | 62 |
| Pourer Covers | 62 |
| Japanese Style Jiggers | 63 |
| Classic Style Jiggers | 63 |
| 3-Piece Bar Shakers | 63 |
| Bar Shaker Cups | 63 |
| Bar Strainers | 63 |
| Muddlers | 63 |
| Citrus Squeezers | 64 |
| Firmgrip™ Paring Knives | 64 |
| Bar Spoons | 64 |
| Pom Tongs | 64 |
| Bottle Openers | 64 |
| Glass Rimmers | 65 |
| Ice Scoops | 66 |
| Pitcher | 66 |
| Bar Mats and Mesh Liner | 67 |
| Single Speed Rails | 67 |
| Double Speed Rails | 67 |

BAR SUPPLIES & EQUIPMENT | 68

| | |
|---|-------|
| Ultimate Garnish Station | 68 |
| First In, First Out Garnish Station | 69 |
| Condiment Dispensers | 69-70 |

BEER & WINE ACCESSORIES | 71

| | |
|--|----|
| Paddle Flights | 71 |
| Wine Flights | 71 |
| Glass Hangers | 71 |
| Ice Buckets & Wine Servers | 72 |
| Wine/Champagne Serving Tools | 72 |
| 2-Piece Windproof Ashtrays | 72 |
| Classic Stacking Deepwell Ashtrays | 72 |
| Economy Stacking Deepwell Ashtrays | 72 |
| Champagne/Wine Buckets & Stand | 73 |



View a video on all the benefits of our 4 Swing Out Trays Glass Rimmer



View a video on crafting the perfect Mojito





WAVERLY COLLECTION™ MIXING GLASSES

Upgrade your bar assortment with our mixing glasses that come in three different designs. These are great for mixing cocktails in style.

- Easy to clean, dishwasher safe



Scan code to view a video on our Waverly Collection™



| Item | Description | Capacity | Min Order/ Case Pack |
|-------------------------------|--|----------|-------------------------|
| MIXING GLASSES - CLEAR | | | |
| a. | 11699 ▶ Starburst Pattern, 10.5 x 9.5 x 14.5cm | 700ml | 1 ea / 6 ea |
| b. | 11698 ▶ Vertical Pattern, 10.5 x 9.5 x 14.5cm | 700ml | 1 ea / 6 ea |
| c. | 11697 ▶ Diamond Cut Pattern, 10.5 x 9.5 x 14.5cm | 700ml | 1 ea / 6 ea |



PVD BARWARE

Refresh your bar assortment with our new PVD barware available in gold, bronze, and gunmetal. We have all the necessary tools to make cocktails in style.

- Stainless Steel with a PVD matte finish
- Easy to clean, dishwasher safe
- Conveniently packaged for cash & carry



NEW

| Item # | Description | Capacity | Min Order/ Case Pack |
|---------------------------------------|--|--------------|-------------------------|
| 18/8 STAINLESS STEEL, GOLD | | | |
| a. | 11867 ▶ 2-Piece Can-on-Can Boston Shaker, 9cm dia x 17cm | 530ml | 1 ea / 6 ea |
| b. | 11814 ▶ Muddler with Plastic Head, 3.5cm dia x 20.5cm | - | 1 ea / 6 ea |
| c. | 11815 ▶ 2-Prong Strainer, 14.5 x 9 x 2cm | - | 1 ea / 6 ea |
| d. | 11816 ▶ Bar Spoon, 3 x 2 x 27.5cm | - | 1 ea / 6 ea |
| e. | 11817 ▶ Jigger, 4cm dia x 6.5cm | 15ml / 30ml | 1 ea / 6 ea |
| 18/8 STAINLESS STEEL, BRONZE | | | |
| f. | 11868 ▶ 2-Piece Can-on-Can Boston Shaker, 9cm dia x 17cm | 530ml | 1 ea / 6 ea |
| g. | 11819 ▶ Muddler with Plastic Head, 3.5cm dia x 20.5cm | - | 1 ea / 6 ea |
| h. | 11820 ▶ 2-Prong Strainer, 14.5 x 9 x 2cm | - | 1 ea / 6 ea |
| i. | 11821 ▶ Bar Spoon, 3 x 2 x 27.5cm | - | 1 ea / 6 ea |
| j. | 11822 ▶ Jigger, 4cm dia x 6.5cm | 15ml / 30ml | 1 ea / 6 ea |
| 18/8 STAINLESS STEEL, GUNMETAL | | | |
| k. | 11869 ▶ 2-Piece Can-on-Can Boston Shaker, 9cm dia x 17cm | 530ml | 1 ea / 6 ea |
| l. | 11824 ▶ Muddler with Plastic Head, 3.5cm dia x 20.5cm | - | 1 ea / 6 ea |
| m. | 11825 ▶ 2-Prong Strainer, 14.5 x 9 x 2cm | - | 1 ea / 6 ea |
| n. | 11826 ▶ Bar Spoon, 3 x 2 x 27.5cm | - | 1 ea / 6 ea |
| o. | 11827 ▶ Jigger, 4cm dia x 6.5cm | 15ml / 30 ml | 1 ea / 6 ea |



BLACK FLORAL PATTERN STAINLESS STEEL BARWARE



| | Item # | Description | Capacity | Min Order/ Case Pack |
|----|--------|--|----------|-------------------------|
| a. | 10778 | 24oz Boston Can, 8.5cm dia x 16.5cm (Fits 10780) | 710 ml | 1 ea / 6 ea |
| b. | 10779 | 16oz Mini Boston Can, 8.5cm dia x 12.5cm | 470 ml | 1 ea / 12 ea |
| c. | 10780 | 28oz Can-on-Can Boston Shaker, 9.5cm dia x 17.5cm (fits 10778) | 830 ml | 1 ea / 12 ea |
| d. | 10781 | 4-Prong Strainer, 12 x 2.5 x 15cm | - | 1 ea / 12 ea |
| e. | 10784 | Bar Spoon with Muddler, 4 x 2 x 31.5cm | - | 1 ea / 24 ea |
| f. | 10785 | Bar Tongs, 5.5 x 2 x 17.5cm | - | 1 ea / 12 ea |
| g. | 10786 | Flat Bottle Opener, 18 x 4 x 0.2cm | - | 1 ea / 12 ea |
| h. | 10787 | 1oz & 2oz Jigger, 5cm dia x 12.5cm | 30/60ml | 1 ea / 6 ea |



CHAMPAGNE FINISH STAINLESS STEEL BARWARE

| | Item # | Description | Capacity | Min Order/ Case Pack |
|----|--------|--|----------|-------------------------|
| a. | 10788 | 24oz Boston Can, 8.5cm dia x 16.5cm (Fits 10790) | 710 ml | 1 ea / 6 ea |
| b. | 10789 | 16oz Mini Boston Can, 8.5cm dia x 12.5cm | 470 ml | 1 ea / 12 ea |
| c. | 10790 | 28oz Can-on-Can Boston Shaker, 9.5cm dia x 17.5cm (fits 10788) | 830 ml | 1 ea / 12 ea |
| d. | 10791 | 4-Prong Strainer, 12 x 2.5 x 15cm | - | 1 ea / 12 ea |
| e. | 10794 | Bar Spoon with Muddler, 4 x 2 x 31.5cm | - | 1 ea / 24 ea |
| f. | 10795 | Bar Tong, 5.5 x 2 x 17.5cm | - | 1 ea / 12 ea |
| g. | 10796 | Flat Bottle Opener, 18 x 4 x 0.2cm | - | 1 ea / 12 ea |
| h. | 10797 | 1oz & 2oz Jigger, 5cm dia x 12.5cm | 30/60ml | 1 ea / 6 ea |

HEY BARTENDER...
ARE YOU
READY
FOR A
REFRESH?

PREMIUM BARWARE IN BLACK ACID ETCH FINISH

Our new barware ranges feature all the essential tools for bartenders while upgrading the look of your bar service.

- Available in Black PVD with our unique Random Acid Etching finish
- Easy to clean, dishwasher safe



18-8 STAINLESS STEEL, BLACK PVD WITH RANDOM ACID ETCH FINISH

| Item # | Description | Capacity | Min Order/ Case Pack |
|--------|--|-----------|-------------------------|
| a. | 10904 2-Piece Cocktail Shaker, 9.5cm dia x 23.5cm | 590 ml | 1 ea / 6 ea |
| b. | 10552 3-Piece Cocktail Shaker, 8.5cm dia x 20cm | 530 ml | 1 ea / 6 ea |
| c. | 10553 3-Piece Cocktail Shaker, 9.5cm dia x 25cm | 700 ml | 1 ea / 6 ea |
| d. | 10554 Boston Can, 8cm dia x 12.5cm | 530 ml | 1 ea / 6 ea |
| e. | 10555 Boston Can, 9cm dia x 17.5cm | 825 ml | 1 ea / 6 ea |
| f. | 10556 4-Prong Strainer, 9cm dia, 12cm dia Prongs | - | 1 ea / 6 ea |
| g. | 10557 Julep Strainer, 8cm dia with 7cm Handle | - | 1 ea / 6 ea |
| h. | 10558 Bar Spoon, 30cm | - | 1 ea / 6 ea |
| i. | 10559 Muddler with Plastic Head, 21cm | - | 1 ea / 6 ea |
| j. | 10560 ½oz / 1oz Japanese Jigger, 4cm dia x 7.5cm | 15 / 30ml | 1 ea / 6 ea |
| k. | 10561 1oz / 1½oz Japanese Jigger, 4.5cm dia x 11cm | 30 / 45ml | 1 ea / 6 ea |
| l. | 10562 1oz / 2oz Japanese Jigger, 4.5cm dia x 12cm | 30 / 60ml | 1 ea / 6 ea |



PREMIUM BARWARE IN BRUSHED FINISH

Upscale barware constructed of durable 18-8 Stainless Steel with elegantly neutral finishes. Our new barware ranges feature all the essential tools for bartenders while upgrading the look of your bar service.

- Available in neutral brushed Stainless Steel finish
- Easy to clean, dishwasher safe



18-8 STAINLESS STEEL, BRUSHED FINISH

| Item # | Description | Capacity | Min Order/ Case Pack |
|--------|---|----------|-------------------------|
| a. | 10520 2-Piece Cocktail Shaker, 9.5cm dia x 23.5cm | 590 ml | 1 ea / 6 ea |
| b. | 10468 3-Piece Cocktail Shaker, 8.5cm dia x 20cm | 530 ml | 1 ea / 6 ea |
| c. | 10469 3-Piece Cocktail Shaker, 9.5cm dia x 25cm | 700 ml | 1 ea / 6 ea |
| d. | 10470 Boston Can, 8cm dia x 12.5cm | 530 ml | 1 ea / 6 ea |
| e. | 10471 Boston Can, 9cm dia x 17.5cm | 825 ml | 1 ea / 6 ea |
| f. | 10472 4-Prong Strainer, 9cm dia, 12cm dia Prongs | - | 1 ea / 6 ea |
| g. | 10473 Julep Strainer, 8cm dia with 7cm Handle | - | 1 ea / 6 ea |
| h. | 10474 Bar Spoon, 30cm | - | 1 ea / 6 ea |
| i. | 10475 Muddler with Plastic Head, 21cm | - | 1 ea / 6 ea |



BAR SOLUTIONS
PREMIUM BARWARE: BLACK ETCHED & BRUSHED



a



b



c



d



e



f



g



h



i

POURMASTER® ONE-PIECE NECK/SPOUT

- Integrated spout is easier to clean than traditional two-piece neck/spout and; no spout to lose, break or get clogged
- Colour-coded for easy identification and quick selection at busy times
- Better ergonomics with textured step design oval neck than competitors
- Thicker thread, improved design with greater overlap for superior hold and leak protection
- Assorted packs include 2 of each colour
- Necks are cross-compatible—our necks are interchangeable with most competitors' jars



MAKE SURE
TO BACK
IT UP

BACKUPS

- Includes container and color-coded cap
- "Assorted" includes 2 of each color for JC1032A
- "Assorted" includes 1 of each color for JC1064A and JC1128A



IT'S ALL ABOUT THE SPOUT

Integrated spout is easier to clean than traditional two-piece neck/spouts

Oval neck with textured step design provides better ergonomics—making gripping, holding, lifting, and pouring safer and easier than the competitors' smooth round design

Features ridges on the base of the neck to give positive grip when tightening or loosening the neck



Thicker thread with improved design and greater overlap for superior hold and leak protection



Integrated vent for fast, smooth pours



Packaged for Cash & Carry



| Item # | Description | Capacity | Min Order/ Case Pack |
|--|--|----------|-------------------------|
| POURMASTER® ONE-PIECE NECK/SPOUT COMPLETES – POLYETHYLENE | | | |
| a. | *10285A Complete, Assorted Colours | 950 ml | 12 ea |
| REPLACEMENT PARTS | | | |
| | *10286BR Brown, Neck/Spout Only | – | 1 ea / 96 ea |
| | *10286GN Green, Neck/Spout Only | – | 1 ea / 96 ea |
| b. | *10286R Red, Neck/Spout Only | – | 1 ea / 96 ea |
| | *10286W White, Neck/Spout Only | – | 1 ea / 96 ea |
| | *10286X Orange, Neck/Spout Only | – | 1 ea / 96 ea |
| | *10286Y Yellow, Neck/Spout Only | – | 1 ea / 96 ea |
| POURMASTER® BACKUPS – HIGH DENSITY POLYETHYLENE | | | |
| | JC1032A Backup. Includes White Jars with Assorted Coloured Lids | 1.0 L | 6 ea |
| c. | JC1064A Backup. Includes White Jars with Assorted Coloured Lids | 1.9 L | 6 ea |
| | JC1128A Backup. Includes White Jars with Assorted Coloured Lids | 3.8 L | 6 ea |
| REPLACEMENT PARTS & ACCESSORIES | | | |
| d. | 10217 Pourmaster Replacement Spouts, Set of 3: Orange, Green & Red | | 1 set |

COMPLETES

- Complete set includes: container, easy grip neck with snap-tight colour pourer and a colour-coded cap for easy storage
- Assorted packs include 2 of each colour for 8032A, 1 of each colour for 8064A & 8128A. Also available in single colours. Add colour code to order.



| Item # | Description | Capacity | Min Order/ Case Pack |
|---|--|----------|-------------------------|
| POURMASTER® – LDPE BOTTLE WITH LONG NECK TOP | | | |
| a. | N32A Pourmaster® with Long Neck Top™ Assorted Colours | 950 ml | 12 ea |
| POURMASTER® – LDPE BOTTLE WITH LOW PROFILE TOP | | | |
| b. | N32LPA Pourmaster® with Low Profile Top™ Assorted Colours | 950 ml | 12 ea |
| POURMASTER® COMPLETES – POLYETHYLENE BOTTLE, SAN PLASTIC SPOUT | | | |
| c. | 8032A Pourmaster® Complete, White Bottle, Assorted Coloured Spouts | 950 ml | 12 ea |
| | 8032_* Pourmaster® Complete, White Bottle, Colour Cap & Spout (Add colour code to order) | 950 ml | 12 ea |
| d. | 8032BKBK Pourmaster® Complete, Black Bottle & Cap, Clear Spout | 950 ml | 12 ea |
| | 8064A Pourmaster® Complete, White Bottle, Assorted Coloured Spouts | 2.2 L | 6 ea |
| e. | 8064_* Pourmaster® Complete, White Bottle, Colour Cap & Spout (Add colour code to order) | 2.2 L | 6 ea |
| f. | 8128A Pourmaster® Complete, White Bottle, Assorted Coloured Spouts | 3.8 L | 6 ea |

*Add colour code to order

IT'S THE COMPLETE PACKAGE

FOR CASH & CARRY

Assorted colours include: green (GN), white (WH), orange (X), red (R), yellow (Y) and brown (BR)

EASY TO ORDER, STOCK, STORE AND IDENTIFY



TO ORDER THE COMPLETE ASSORTMENT:
8064 A
item color
number code

TO ORDER A BOTTLE WITH RED POURER:
8064 RD
item color
number code



THE PROPER POUR MEETS THE PERFECT COVER

Accurately pour your craft mixes with reduced over pours, for more consistent drinks that don't rob profits.

- Multi-ball technology ensures accurate measured pours and prevents evaporation
- Proper Pour® III Measured Pourers feature a non-collared pour solution, ideal for cocktail ingredients

POURERS

Provide bartending staff with simple sanitary solutions to keep your service efficient and your customers safe.



FLIP TOP & SCREEN-EM™

Keep liquors free from contaminants



POURER COVERS



Air vent tube ensures smooth and consistent pouring

| Item # | Description | Capacity | Min Order/ Case Pack |
|--|---|----------|----------------------|
| MEASURED POURERS | | | |
| a. *4244A | Black with Blue Dip Tube, 6 x 8mm opening | 25 ml | 12 ea |
| PROPER POUR® III POURERS – NON-COLLARED | | | |
| b. 146A | Red with Blue Dip Tube, 6 x 8mm opening | 25 ml | 12 ea / 144 ea |
| FREE FLOW POURERS – ASSORTED | | | |
| c. *330 | S/S Tapered Speed Pourer, 5mm opening | - | 12 ea / 60 ea |
| d. *320A | S/S Jet Pourer, 8mm opening | - | 12 ea / 60 ea |
| e. *320C | S/S Hinged Flip Cap Pourer, 8mm opening | - | 12 ea / 60 ea |
| f. *H320C | S/S Hinged Flip Cap Pourer (Pack of 2) | - | 1 pk |
| g. 345 | 18-8 S/S Pourer, 10mm opening | - | 12 ea / 60 ea |
| g. *597P | S/S Weighted Flip Cap Pourer, 15 x 8mm opening | - | 12 ea / 60 ea |
| h. *598P | S/S Hinged Flip Cap Speed Pourer Spout, Plastic Vent Tube, 15 x 8mm opening | - | 12 ea / 60 ea |
| FREE FLOW WHISKEY POURERS – PLASTIC | | | |
| i. 1802 | Clear, 6mm opening | - | 12 ea / 144 ea |
| ECONOMY POURERS – CHROME PLATED ABS & PLASTIC | | | |
| j. *35R | Red Pourer, 9 x 5mm opening | - | 12 ea / 144 ea |
| k. *35BK | Black Pourer, 9 x 5mm opening | - | 12 ea / 144 ea |
| l. *35G | Green Pourer, 9 x 5mm opening | - | 12 ea / 144 ea |
| m. *35W | White Pourer, 9 x 5mm opening | - | 12 ea / 144 ea |
| SCREEN EM™ POURERS – PLASTIC, SANITARY SCREEN SPOUT | | | |
| n. *295X | Smoke Pourer, 8mm opening | - | 12 ea / 144 ea |
| POURER COVERS – PLASTIC†† | | | |
| o. *DCL | Universal Liquor Pourer Cover, Translucent Clear (12 per pack) | - | 1 pk |
| p. *DCBK | Dust Cap Cover for Liquor Pourers, Opaque Black (12 per pack) | - | 1 pk |

JIGGERS & SHAKERS

| Item # | Description | Capacity | Min Order/ Case Pack |
|--|------------------------------|------------|-------------------------|
| JAPANESE STYLE JIGGERST† | | | |
| *JJ1202 | ½oz & 1oz, 4.5cm dia x 7.5cm | 15 & 30 ml | 1 ea / 6 ea |
| a. *JJ1205 | 1oz & 1½oz, 4.5cm dia x 11cm | 30 & 45 ml | 1 ea / 6 ea |
| *JJ1206 | 1oz & 2oz, 5cm dia x 12.5cm | 30 & 60 ml | 1 ea / 6 ea |
| CLASSIC STYLE JIGGERS | | | |
| *H1206 | 1oz & 2oz, 6.5cm dia x 8cm | 30 & 60 ml | 6 ea |
| 3-PIECE BAR SHAKERS – STAINLESS STEEL | | | |
| *375 | 8oz, 8cm dia x 15cm | 265 ml | 6 ea |
| b. *376 | 16oz, 8cm dia x 19cm | 445 ml | 6 ea |
| *377 | 28oz, 9.5cm dia x 25cm | 830 ml | 6 ea |
| BAR SHAKER CUPS – STAINLESS STEEL | | | |
| c. 76 | 16oz, 8cm dia x 12cm | 460 ml | 12 ea |
| d. 77 | 28oz, 9.5cm dia x 17.5cm | 870 ml | 12 ea |
| *H77 | 28oz, 9.5cm dia x 17.5cm | 870 ml | 6 ea |

†Not Government Stamped

BAR TOOLS

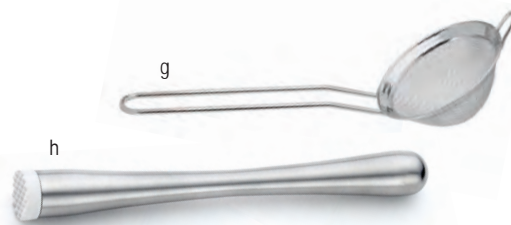

| Item # | Description | Min Order/ Case Pack |
|--|---|-------------------------|
| BAR STRAINERS – STAINLESS STEEL | | |
| e. S209 | 4 Prong Bar Strainer, 11.5 x 15 x 2cm | 1 ea / 12 ea |
| f. *H211 | Premium 2 Prong Strainer, 19 x 9.5 x 2.5cm | 6 ea |
| g. *HS220 | Fine Mesh Cocktail Strainer, 7 cm dia with 13cm Handle | 12 ea |
| MUDDLERS – STAINLESS STEEL WITH PLASTIC TIP | | |
| h. *H4258 | Muddler, Stainless Steel with Plastic Tip, 2.5cm dia x 22cm | 6 ea |

JIGGERS JAPANESE & CLASSIC STYLE

- Combo, rolled edge
- 18/8 Stainless Steel
- Capacity stamping in ml & oz



Japanese jiggers have a tall, slender profile compared to the Classic version with a brushed finish and dual (oz/ml) capacity stamping.

*Not government stamped



3-PIECE BAR SHAKERS

- Built-in strainer separates your chilled cocktails from the ice
- Each 3-piece set includes: shaker, lid and built-in strainer



BAR SHAKERS



BAR STRAINERS

CITRUS SQUEEZERS

- Handheld juicing tool, ideal for citrus fruits
- Colour-coded for intended use
- Features a built in draining spout to eliminate seeds



PERFECTGRIP® PARING KNIVES

- A convenient tool that no bar should be without



NEW



| Item # | Description | Min Order/ Case Pack |
|--|---|-------------------------|
| CITRUS SQUEEZERS – COATED ZINC ALLOY OR STAINLESS STEEL | | |
| a. V119 | Yellow, Coated Aluminium, 25.5 x 10 x 6cm | 1 ea / 6 ea |
| b. V119GN | Green, Coated Aluminium, 25.5 x 10 x 6cm | 1 ea / 6 ea |
| *H119Y | Yellow, Coated Aluminium, 25.5 x 10 x 6cm | 1 ea / 6 ea |
| c. 95 | Lime Squeezer, Stainless Steel, 16 x 10.5 x 3cm | 12 ea |
| PERFECTGRIP® TOOLS | | |
| d. 10973 ▶ | Paring Knife, 9cm blade | 1 ea / 12 ea |
| BAR SPOONS – STAINLESS STEEL | | |
| e. *H503K | 30.5cm Spoon with Fork | 1 ea / 6 ea |
| f. 501K | 28cm Spoon with Red Knob | 24 ea |
| *H501K | 28cm Spoon with Red Knob | 12 ea |

| Item # | Description | Min Order/ Case Pack |
|---|---------------------------|-------------------------|
| POM TONGS – STAINLESS STEEL | | |
| g. *H1246 | 17cm Pom Tongs | 6 ea |
| h. 526T | 15cm Pom Tongs | 48 ea |
| BOTTLE OPENERS – STAINLESS STEEL | | |
| j. 396 | 17.5cm Flat Pocket Opener | 1 ea / 36 ea |

WITH SUGAR ON TOP

GLASS
RIMMERS *



Our professional 5-Tray Glass Rimmer includes four swing-out trays and one sponge tray to prep cocktail vessels, margarita glasses and shots with an extra special touch.



Compact design
for easy storage



| Item # | Description | Min Order/ Case Pack |
|------------------------------------|---|-------------------------|
| GLASS RIMMERS - POLYSTYRENE | | |
| a. *H5633 | 4 Swing-Out Trays, Black, 16 x 18 x 11cm | 1 ea / 4 ea |
| GLASS RIMMERS - ABS PLASTIC | | |
| b. *H633 | 3 Swing-Out Trays, Black, 16 x 20 x 7.5cm | 4 ea |





a

KEEP YOUR ICE NICE

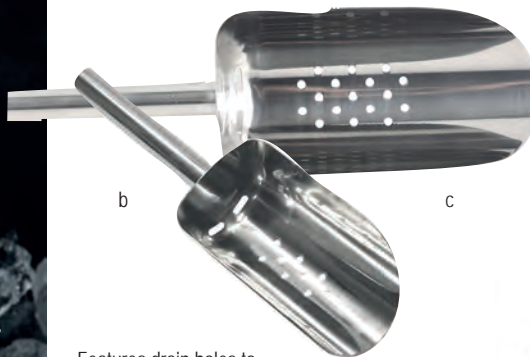

b

c

Features drain holes to prevent melted ice from watering down drinks

ICE SERVICE TOOLS



d

e



Aluminium Scoops are Hand Wash Only



| Item # | Description | Capacity | Min Order/ Case Pack |
|---|-------------|----------|----------------------|
| PERFORATED ICE SCOOPS - 18/8 STAINLESS STEEL | | | |

| | | | | |
|----|---------|-------------------------------|--------------|--------------|
| a. | BSC0610 | 6-10oz Stainless Steel Scoop | 170 - 290 ml | 1 ea / 12 ea |
| b. | BSC1216 | 12-16oz Stainless Steel Scoop | 350 - 470 ml | 1 ea / 12 ea |
| c. | BSC2024 | 20-24oz Stainless Steel Scoop | 590 - 710 ml | 1 ea / 12 ea |

SOLID ICE SCOOPS - STAINLESS STEEL OR ALUMINIUM

| | | | | |
|----|-----|---------------------------|--------|--------------|
| d. | 512 | 4oz Stainless Steel Scoop | 120 ml | 12 ea |
| e. | 605 | 5oz Aluminium Scoop† | 150 ml | 1 ea / 12 ea |
| | 612 | 12oz Aluminium Scoop† | 355 ml | 1 ea / 12 ea |
| | 624 | 24oz Aluminium Scoop † | 710 ml | 1 ea / 12 ea |
| | 638 | 38oz Aluminium Scoop† | 1.1 L | 1 ea / 12 ea |
| | 658 | 58oz Aluminium Scoop † | 1.7 L | 1 ea / 12 ea |
| | 685 | 85oz Aluminium Scoop † | 2.5 L | 1 ea / 12 ea |

POLYCARBONATE ICE SCOOPS

| | | | | |
|----|-------|--------------------------|--------|--------------|
| f. | 11401 | 6oz Polycarbonate Scoop | 180 ml | 1 ea / 12 ea |
| g. | 11402 | 12oz Polycarbonate Scoop | 355 ml | 1 ea / 12 ea |
| h. | 11403 | 24oz Polycarbonate Scoop | 710 ml | 1 ea / 12 ea |
| i. | 11404 | 32oz Polycarbonate Scoop | 950 ml | 1 ea / 12 ea |
| j. | 11405 | 64oz Polycarbonate Scoop | 2 L | 1 ea / 12 ea |

PITCHER

| | | | | |
|----|-----|---------------|-------|--------------|
| k. | 364 | Clear Pitcher | 1.8 L | 1 ea / 12 ea |
|----|-----|---------------|-------|--------------|

† Hand wash only

Durable and lightweight polycarbonate ice scoops

BEVERAGE PITCHER

Crystal Clear SAN Plastic

BPA FREE



j

BAR MATS & MESH LINERS



- A sanitary way to dry and store glassware
- Non-slip, drainable mats for your washing area, shelves or other storage
- Customise any shelf, countertop, sink or cooler with a variety of sizes/styles

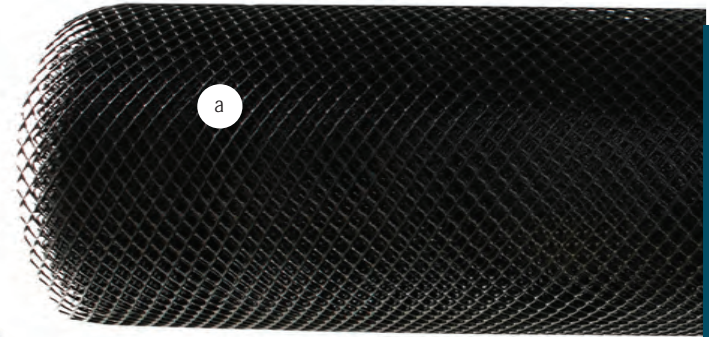

SPEED RAILS

- All speed rails are Stainless Steel
- Universal speed rails have adjustable length
- Single and double speed rails come in 56, 81 or 107cm length

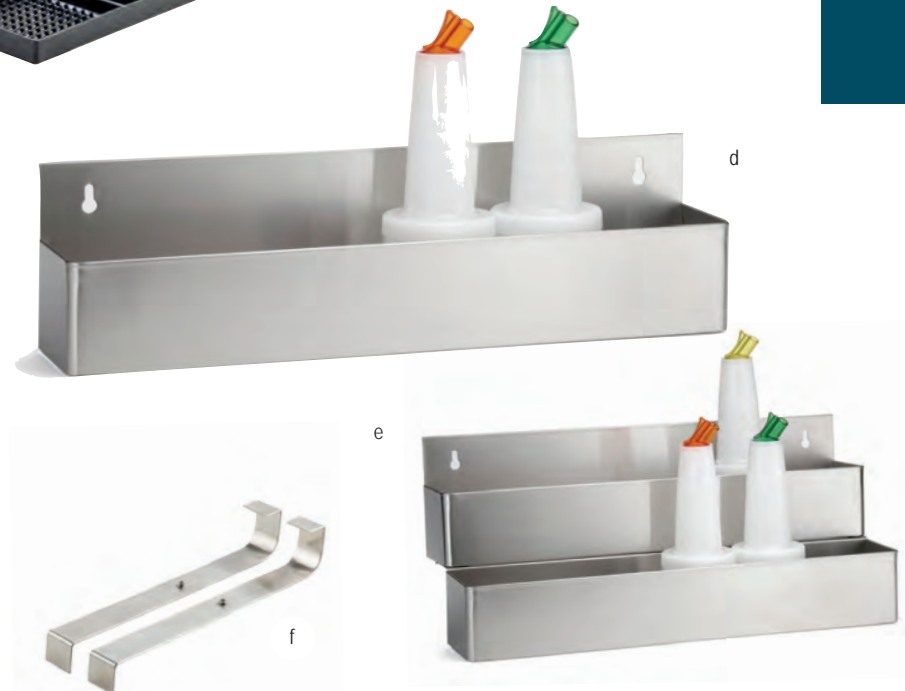

| Item # | Description | Min Order/ Case Pack |
|---|---|-------------------------|
| BAR MATS & MESH LINERS – PLASTIC, RUBBER | | |
| a. | 5834 Black Bar Mesh, 12 metre roll | 1 ea |
| b. | 1218BK Black Service Mat, 45.5 x 30.5 x 1cm | 1 ea / 12 ea |
| c. | 753BK Black Bar Mat, 68.5 x 8 x 1cm | 1 ea / 12 ea |
| SINGLE SPEED RAILS – STAINLESS STEEL | | |
| d. | 5122 56 x 10 x 15cm (Holds (5) 950 ml Pourmaster®) | 1 ea / 6 ea |
| | 5132 81 x 11.5 x 16cm (Holds (8) 950 ml Pourmaster®) | 1 ea / 6 ea |
| | 5142 107 x 10 x 15cm (Holds (11) 950 ml Pourmaster®) | 1 ea / 4 ea |
| DOUBLE SPEED RAILS – STAINLESS STEEL | | |
| e. | 5222 56 x 20.5 x 24cm (Holds up to (10) 950 ml Pourmaster®) | 1 ea / 3 ea |
| | 5232 81x 20.5 x 25cm (Holds up to (16) 950 ml Pourmaster®) | 1 ea / 3 ea |
| | 5242 107 x 21 x 24cm (Holds up to (22) 950 ml Pourmaster®) | 1 ea / 3 ea |
| REPLACEMENT PARTS & ACCESSORIES | | |
| f. | 5200 Hanger Straps, Set of 2 | 1 ea / 100 ea |

GARNISH STATIONS

FIRST IN, FIRST OUT



FIRST
IN
FIRST
OUT
THAT'S
WHAT IT'S
ALL
ABOUT



Includes:
(1) 950 ml and
(4) 475 ml inserts,
plus (2) Caddies
to keep condiments
organised

ULTIMATE GARNISH STATION



All-in-one garnish
station includes
(5) swing-out trays,
and (1) sponge

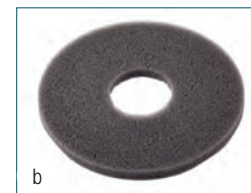

| Item # | Description | Min Order/ Case Pack |
|--|---|-------------------------|
| ULTIMATE GARNISH STATION – BLACK POLYSTYRENE BASE, CLEAR (PS) LID AND POLYPROPYLENE INSERTS | | |
| a. BCD1400 | Ultimate Garnish Station, Includes: (1) 950 ml, (4) 475 ml, (2) Caddies and Integrated 5-Tray Rimming Station, 62 x 18.5 x 16cm | 1 ea / 4 ea |
| REPLACEMENT PARTS & ACCESSORIES | | |
| 105 | 475 ml Insert, White, 14 x 7 x 7.5cm | 1 ea / 12 ea |
| 107 | 950 ml Insert, White, 14.5 x 14 x 7.5cm | 1 ea / 12 ea |
| b. 667 | Round replacement sponge, 14cm dia x 1cm | 12 ea |

Chillable design for food safety standards



a

US Patent #9,936,822



Stackable design features bottom rotating lid

| Item # | Description | Min Order/ Case Pack |
|---|---|-------------------------|
| FIRST IN, FIRST OUT GARNISH STATION – BLACK ABS PLASTIC BASE, CLEAR ABS LID, POLYPROPYLENE INSERTS | | |
| a. BCD6000 | Garnish Station, (6) 710 ml White Inserts, 51 x 17 x 16cm | 1 ea |
| b. BCD6000BK | Garnish Station, (6) 710 ml Black Inserts, 51 x 17 x 16cm | 1 ea |
| CONDIMENT DISPENSERS – BLACK ABS PLASTIC BASE, CLEAR ABS LID, WHITE POLYPROPYLENE INSERTS | | |
| c. 102 | 6 Compartment Holder with Enclosed Bottom, (6) 475ml, 49.5 x 15.5 x 11cm | 1 ea / 6 ea |
| d. 103 | 4 Compartment Holder with Enclosed Bottom, (4) 800ml, 49.5 x 15.5 x 11cm | 1 ea / 6 ea |
| e. 104 | 3 Compartment Holder with Enclosed Bottom, (3) 950 ml, 49.5 x 15.5 x 11cm | 1 ea / 6 ea |

b

Fill from top, dispense from bottom for an effective food rotation system

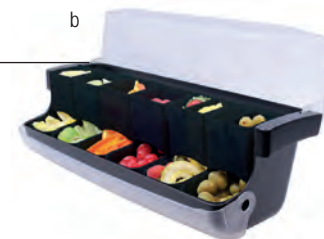

CONDIMENT DISPENSERS & CADDIES



BPA FREE

Keep your condiments cool and fresh, perfect for craft cocktails



c



d



e

CONDIMENT DISPENSERS & CADDIES



Clear, lightweight, BPA-Free plastic designs with ice chamber keep your condiments ready to serve! Includes clear plastic bins which are removable for easy cleaning. Lid keeps your fruits and other garnishes fresh and free from contaminants.

- Easy to clean, handwash recommended
- Conveniently packaged for Cash & Carry



c

Pint inserts are dishwasher safe; housing and lid should be washed by hand with a non-abrasive cloth



Tongs included



a



b



d



e



f

CHILLIN' CONDIMENT CADDIES

| Item # | Description | Min Order/ Case Pack |
|--|--|-------------------------|
| CONDIMENT DISPENSERS – CLEAR PLASTIC | | |
| a. *10006 | Polystyrene with Enclosed Bottom, (4) 700ml Inserts, 41 x 16 x 12.5cm | 6 ea |
| b. *10007 | Polystyrene with Enclosed Bottom, (5) 565ml Inserts, 41 x 16 x 12.5cm | 6 ea |
| CONDIMENT DISPENSERS – STAINLESS STEEL, CLEAR ACRYLIC LID | | |
| 1602 | 2 Compartment Holder, (2) 950 ml Plastic Inserts, Holds Four Freeze Packs (4937 not included), Notched Lid, Enclosed Bottom 30.5 x 15 x 12.5cm | 1 ea / 16 ea |
| 1603 | 4 Compartment Holder, (4) 475ml Plastic Inserts, Holds Four Freeze Packs (4937 not included), Enclosed Bottom, 30.5 x 15 x 12.5cm | 1 ea / 16 ea |
| c. *H1604 | Bar Caddy Set, Includes (4) 475ml Plastic Inserts and Stainless Steel Tongs, Open Bottom, 30.5 x 15 x 9cm | 1 ea / 4 ea |
| d. 1604 | Bar Caddy Set, Includes (4) 475ml Plastic Inserts, Open Bottom, 30.5 x 15 x 9cm | 1 ea / 16 ea |
| 1605 | 5 Compartment Holder, (5) 475ml Plastic Inserts, Open Bottom, 38 x 15 x 9cm | 1 ea / 16 ea |
| 1606 | 6 Compartment Holder, (6) 475ml Plastic Inserts, Open Bottom, 45 x 15 x 9cm | 1 ea / 16 ea |
| REPLACEMENT PARTS & ACCESSORIES | | |
| e. 4937 | Freeze Pack for 1602 and 1603 | 1 ea / 36 ea |
| 1607 | 475ml Insert, White | 1 ea / 120 ea |
| 105 | 475ml Insert, White | 1 ea / 12 ea |
| 107 | 950ml Insert, White | 1 ea / 12 ea |
| BAR CADDY | | |
| f. 101 | Black, 24 x 15 x 10.5cm | 1 ea / 12 ea |

FLIGHTS AND HANGERS

PADDLE FLIGHTS



- Perfect for serving a variety of drinks or dessert samplings
- Recessed holes for holding small glasses, ramekins, sauce cups, etc.(not included)

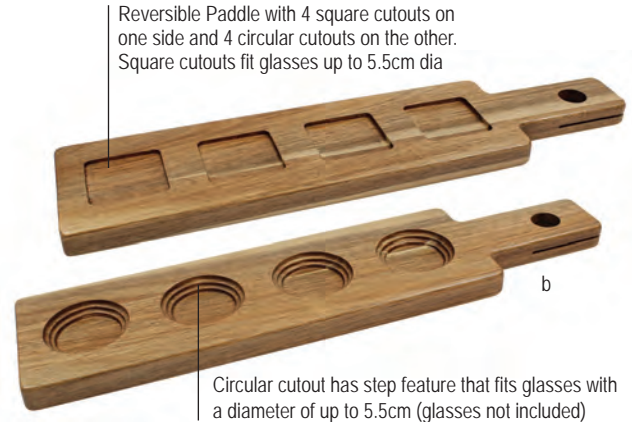

Reversible Paddle with 4 square cutouts on one side and 4 circular cutouts on the other. Square cutouts fit glasses up to 5.5cm dia

Circular cutout has step feature that fits glasses with a diameter of up to 5.5cm (glasses not included)

| Item # | Description | Min Order/ Case Pack |
|--|--|-------------------------|
| PADDLE FLIGHTS | | |
| a. 20002 | Better Burger Spatula Drinks Flight, 31 x 8.5cm, with 13cm Handle (Product has (4) 6.3 x 1.8cm Indentations) | 1 ea / 12 ea |
| b. FLIGHT1 | Bamboo, Holds 4 Glasses (Up to 5.5cm dia) 43 x 10 x 1.5cm | 1 ea / 10 ea |
| WINE FLIGHT - BLACK POWDER COATED STEEL | | |
| c. WF200BK | Tasting Flight, 19 x 18 x 36cm | 1 ea / 4 ea |

GLASS HANGERS



| Item # | Description | Min Order/ Case Pack |
|---|-------------|-------------------------|
| GLASS HANGER - BRASS | | |
| d. GHB10 | 25.5cm | 1 ea / 12 ea |
| GHB16 | 40.5cm | 1 ea / 12 ea |
| GHB24 | 61cm | 1 ea / 12 ea |
| GLASS HANGER - CHROME PLATED METAL | | |
| GHC10 | 25.5cm | 1 ea / 12 ea |
| GHC16 | 40.5cm | 1 ea / 12 ea |
| e. GHC24 | 61cm | 1 ea / 12 ea |



WINE FLIGHT

- An appealing and convenient way to serve wine tastings
- WF200BK holds up to (3) 12.5cm dia wine glasses (Not Included)

13.5cm maximum stem length

Also a convenient option to serve your condiments and sides

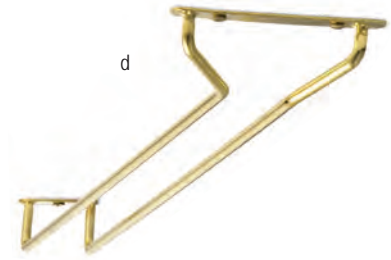

ASSORTED WINE SERVERS & STAINLESS STEEL ICE BUCKETS



For best results with marble coolers, place unit in the freezer before use. Do not fill with ice.



| Item # | Description | Capacity | Min Order/ Case Pack |
|--------------------------------------|--|-----------------------|-------------------------|
| ICE BUCKETS – STAINLESS STEEL | | | |
| a. RIB76 | Double Wall Bucket, 16cm dia x 16.5cm, 17.5cm dia with Handles | 1.7 L | 1 ea / 12 ea |
| WINE SERVER – MARBLE | | | |
| b. *5488 | Black, 12.5cm dia x 18.5cm | Holds 10cm dia bottle | 1 ea / 6 ea |
| c. *5488W | White, 12.5cm dia x 18.5cm | Holds 10cm dia bottle | 1 ea / 6 ea |
| WINE SERVER – SAN PLASTIC | | | |
| d. PB5119 | Wine Bucket, 18.5cm dia x 23cm, 22cm dia with Handles | 2.6 L | 1 ea / 12 ea |

WINE & CHAMPAGNE SERVING TOOLS



| Item # | Description | Min Order/ Case Pack |
|-------------------------------------|--|-------------------------|
| WINE/CHAMPAGNE SERVING TOOLS | | |
| e. *H1230C | Waiter's Corkscrew, Black Rubber-Like Handle | 6 ea |
| f. 398 | Champagne Bottle Sealer, Stainless Steel | 1 ea / 24 ea |
| *H398 | Champagne Bottle Sealer, Stainless Steel | 6 ea |
| g. *H1229 | Premium Winged Corkscrew | 6 ea |

ASHTRAYS



| Item # | Description | Min Order/ Case Pack |
|--|----------------------------------|-------------------------|
| 2-PIECE WINDPROOF – STAINLESS STEEL | | |
| h. WPA5SS | 18/8 Stainless Steel, 12.5cm dia | 12 ea |
| 2-PIECE WINDPROOF – MELAMINE | | |
| i. WPA5BKEU | Black, 12.5 x 12.5 x 5.08 cm | 12 ea |
| CLASSIC STACKING DEEPWELL, BLACK PHENOLIC | | |
| j. *CST363B-1 | Black, 10cm dia (12 per pack) | 6 pk |
| ECONOMY STACKING DEEPWELL, BLACK PHENOLIC | | |
| k. 131B | Black, 8.5cm dia | 144 ea |
| l. ST363B-1 | Black, 10cm dia | 12 ea |
| m. 707B | Black, 9cm dia | 144 ea |

CHAMPAGNE/WINE BUCKETS & STANDS

Our Champagne / Wine Buckets & Stands are great for keeping champagne on ice or wines chilled without taking up valuable tabletop space



Unique hammered finish

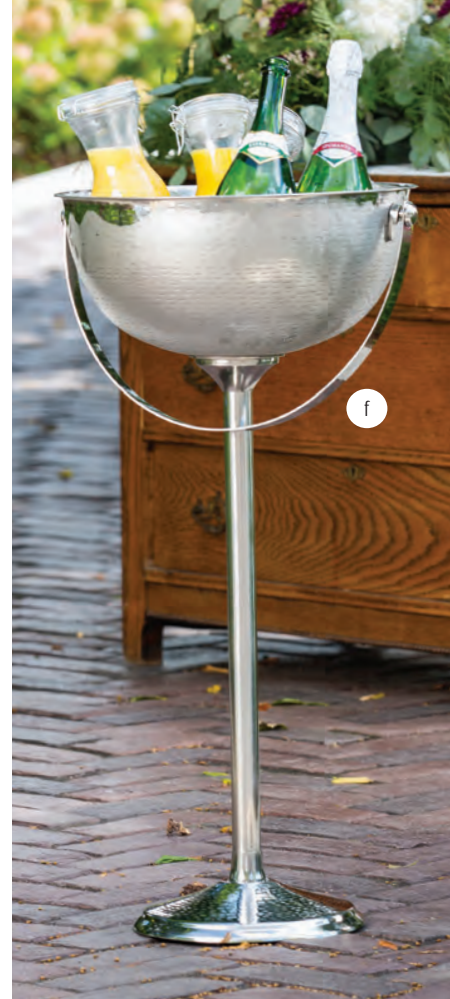
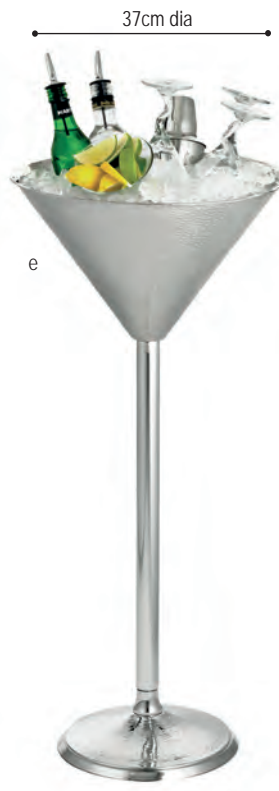

BAR SOLUTIONS
CHAMPAGNE / WINE BUCKET AND STANDS

| Item # | Description | Capacity | Min Order/ Case Pack |
|--|---|----------|-------------------------|
| CHAMPAGNE/WINE BUCKETS & STANDS – ASSORTED FINISHES | | | |
| a. 5188 | Stainless Steel Bucket, Mirror Finish (Fits stand 5288), 22cm dia x 25.5cm, 24cm dia with Handles | 7.6 L | 1 ea / 6 ea |
| b. 5288 | Chrome Plated Bucket Stand (Fits 5188), 20cm dia x 76cm | | 1 ea / 12 ea |
| c. 5198 | Stainless Steel Bucket, Shiny Hammered Finish (Fits stand 5398), 20cm dia x 21.5cm, 22cm dia with Handles | 7.6 L | 1 ea / 6 ea |

| Item # | Description | Capacity | Min Order/ Case Pack |
|--|--|----------|-------------------------|
| CHAMPAGNE/WINE BUCKETS & STANDS – ASSORTED FINISHES | | | |
| d. 5398 | Stainless Steel Bucket Stand (Fits 5198) 20cm dia x 59cm | | 1 ea / 6 ea |
| e. RS1432 | Remington™ Rice Pattern Martini Glass Beverage Stand, Stainless Steel, 37cm dia x 82.5cm | 4.4 L | 1 ea |
| f. RS2132 | Remington™ Rice Pattern Round Beverage Stand with Handle, Stainless Steel, 40.5cm dia x 81cm | 9.8 L | 1 ea |

TOP CLASS TABLETOP

Mix & match our tabletop collections to enhance your customers' dining experience. Contemporary in design, our accessories will welcome your guests in a stylish and elegant manner.



COLLECTIONS | 76

- Gemelli Collection™ 76
- Marbella Collection™ 76
- Prima Collection™ 77
- European Collection™ 77
- Beehive Collection™ 78
- Syrup Dispenser 79
- Salad Dressing Gadgets 79
- Seafood Tools 79
- Siena Collection™ 80
- Serving Bottles 80



SALT & PEPPER | 80

- Eiffel Tower Salt & Pepper Shakers 80
- Nostalgia Salt & Pepper Shakers 80
- Cube Salt & Pepper Shakers 80
- Resealable Salt & Pepper Shakers 80
- Mason Jar Salt & Pepper Shakers 80
- Mini Mason Jar Salt & Pepper Shakers 80
- Paneled, Square & Round
Salt & Pepper Shakers 81
- Salt and Pepper Mill Sets 82
- Large Pepper Mill 82
- Authentic Collection™ 83
- Condiment Jar 83

SHAKERS & TABLETOP CADDIES | 84

- Plastic Shakers 84
- Glass Shakers 84
- Versa Rack™ Condiment Racks 85
- Paper Towel Holder & Caddy 85
- Table Sachet Holders 85

GO GREEN AUTHENTICALLY.

Our Eco-friendly Authentic Collection™ oil and vinegar and salt and pepper shaker bottles are made from recycled green. See page 87 for details.





AROUND THE WORLD TO YOUR TABLETOP

GEMELLI COLLECTION™

- Green tint glass bottles are dishwasher safe
- Racks and pourers are hand wash only



MARBELLA COLLECTION™

- Eco-friendly, recycled green glass
- Green tint glass bottles are dishwasher safe
- Tops are hand wash only



| Item # | Description | Capacity | Min Order/ Case Pack |
|--|--|----------|-------------------------|
| GEMELLI COLLECTION™ – CHROME PLATED METAL RACKS | | | |
| a. *H918N | 3-pc Set, includes (2) 8.5 oz Bottles with Pourers (599P) & Chrome Plated Rack (918R), 12 x 9 x 30.5cm | 250 ml | 6 ea |
| REPLACEMENT PARTS & ACCESSORIES | | | |
| b. 918 | 2-pc Set, includes (2) 8.5 oz Bottles with Pourers (599P) | 250 ml | 6 ea |
| | 918R Rack for 918, 12 x 9 x 30.5cm | | 1 ea / 6 ea |
| c. 599P | 18-8 Stainless Steel Universal Pourer with Plastic Vent Tube | | 12 ea / 60 ea |
| d. 597P | 18-8 Stainless Steel Weighted Flip Cap Pourer | | 12 ea / 60 ea |
| MARBELLA COLLECTION™ – RECYCLED GREEN GLASS, CHROME PLATED METAL TOPS | | | |
| e. 615 | 3 oz Salt & Pepper Shakers with Chrome Plated ABS Tops (615T) | 90 ml | 24 ea |

PRIMA COLLECTION™



- Green tint glass bottles are dishwasher safe
- Racks and pourers are hand wash only

CLASSIC CRUETS

| Item # | Description | Capacity | Min Order/ Case Pack |
|---|---|----------|-------------------------|
| PRIMA COLLECTION™– STAINLESS STEEL POURERS, CHROME PLATED OR BLACK POWDER COATED METAL RACKS | | | |
| a. | *H9085N 3-pc Set, 8.5 oz, Includes: (2) 9085 & (1) 9085R, 11 x 6 x 32cm | 250 ml | 6 ea |
| b. | *H9085NBK Black 3-pc Set, 8.5 oz, Includes: (2) 9085 & (1) 9085RBK, 11 x 6 x 32cm | 250 ml | 6 ea |
| c. | *H916N 3-pc Set, 16 oz, Includes: (2) 916 & (1) 916R, 13 x 7 x 38cm | 470 ml | 6 ea |
| d. | RSB33 Resealable Prima Bottle | 1L | 12 ea |
| e. | 60125 Clear Bottle, 6 oz with Stainless Steel Pourer (599P) | 180 ml | 12 ea |
| f. | 9085 Clear Bottle, 8.5 oz with Stainless Steel Pourer (599P) | 250 ml | 12 ea |
| | 916 Clear Bottle, 16 oz with Stainless Steel Pourer (599P) | 470 ml | 12 ea |
| REPLACEMENT PARTS & ACCESSORIES | | | |
| | 9085R Rack for H9085N, 11 x 6 x 32.5cm | | 1 ea / 6 ea |
| | 9085RBK Black Rack for H9085NBK, 11 x 6 x 32.5cm | | 1 ea / 6 ea |
| | 916R Rack for H916N, 13 x 6.5 x 37cm | | 1 ea / 6 ea |
| | 599P 18-8 Stainless Steel Universal Pourer with Plastic Vent Tube | | 12 ea / 60 ea |
| EUROPEAN COLLECTION™– STAINLESS STEEL TOPS, CHROME PLATED METAL RACKS | | | |
| g. | 600N 3-pc Set, 6 oz, Includes: (2) 600 & (1) 600R | 175 ml | 1 ea / 6 ea |
| REPLACEMENT PARTS & ACCESSORIES | | | |
| h. | 600 6 oz Bottle with 18-8 Stainless Steel Top (600T) | 180 ml | 12 ea |



EUROPEAN COLLECTION™



- Clear glass bottles are dishwasher safe
- Racks and tops are hand wash only



WELCOME TO THE HIVE

BEEHIVE COLLECTION™



- Collection designed for all table and buffet settings
- Choose from a wide range of shapes, capacities and dispenser tops



| Item # | Description | Capacity | Min Order/ Case Pack |
|--|--|----------|-------------------------|
| BEEHIVE COLLECTION™ – GLASS, ABS, STAINLESS STEEL & CHROME PLATED METAL | | | |
| a. | BH2 Salt & Pepper Shakers, 2 oz with Top (154T). | 60 ml | 24 ea |
| b. | BH3 Oil & Vinegar Bottles, 6 oz with Top (600T) | 180 ml | 12 ea |
| c. | BH7 Syrup Dispenser, 6 oz with Top (1370T) | 180 ml | 12 ea |
| d. | BH855 Pourer, 12 oz, Center Pour with Top (55T) | 350 ml | 12 ea |
| e. | *HBH860 Pourer, 12 oz, Pour Spout with Top (60T) | 355 ml | 12 ea |
| REPLACEMENT PARTS & ACCESSORIES | | | |
| 600T | 18-8 Stainless Steel Top for BH3, 600, 600N, 600ST, H600N2 | – | 12 ea |
| 1370T | Chrome Plated Metal Top for BH7 | – | 1 ea / 24 ea |
| 1370G | Gasket for BH7 | – | 1 ea / 12 ea |
| 55T | Stainless Steel Tops for BH855 | – | 12 ea |

SYRUP DISPENSER GLASS WITH ABS TOP

- Easy-to-use dispensing options for syrups and thick sauces



SALAD DRESSING DISPENSERS

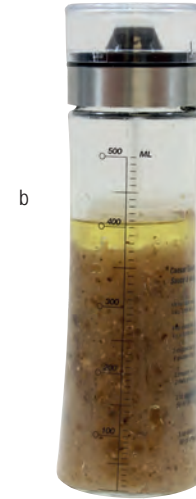

| Item # | Description | Capacity | Min Order/ Case Pack |
|--|-------------------------------|----------|-------------------------|
| GLASS SYRUP DISPENSERS—CHROME PLATED METAL ABS TOPS | | | |
| a. 406 | 6 oz, Chrome Plated Metal Top | 180 ml | 12 ea |
| GLASS WITH PLASTIC & METAL TOP | | | |
| b. *HDS492 | Salad Dressing Shaker | 550 ml | 6 ea |
| c. *HVN142 | Olive Oil Infuser | 550 ml | 6 ea |

SEAFOOD TOOLS



| Item # | Description | Min Order/ Case Pack |
|----------------------------|--|-------------------------|
| SEAFOOD TOOLS—METAL | | |
| d. 513 | Round Handle Lobster Crackers, Chrome Plated | 1 ea / 24 ea |
| e. 514 | Double Jaw Lobster Crackers, Chrome Plated | 1 ea / 24 ea |
| f. 515 | Lobster Crackers, Red Enamelled Cast Aluminium | 1 ea / 24 ea |
| g. *522 | Shellfish Forks, Chrome Plated (4 per pack) | 1 pk / 12 pk |

SWEET OR SAVORY



SIENA COLLECTION™



- Glass bottles are dishwasher safe
- Racks and tops are hand wash only



| Item # | Description | Capacity | Min Order/ Case Pack |
|---|---|----------|----------------------|
| SIENA COLLECTION™ – CLEAR GLASS, STAINLESS STEEL POURERS | | | |
| a. 611 | Bottle, 6 oz with Pourers (599P) | 180ml | 12 ea |
| b. 611N | Set of (2) 611 Bottles and Chrome Plated Rack | 180ml | 1 ea / 6 ea |

SERVING BOTTLES OIL & VINEGAR



*



| Item # | Description | Capacity | Min Order/ Case Pack |
|---|--|----------|----------------------|
| OIL & VINEGAR SERVING BOTTLES – CLEAR GLASS BOTTLES, STAINLESS STEEL POURERS | | | |
| c. *H931 | Clear Glass Bottle, 16 oz with Pourer (599P) | 475 ml | 6 ea |
| REPLACEMENT PARTS & ACCESSORIES | | | |
| 599P | 18-8 Stainless Steel Universal Pourer with Plastic Vent Tube | – | 12 ea / 60 ea |
| 597P | Weighted Flip Cap Pourer with Stainless Steel Vent Tube | – | 12 ea / 60 ea |

SALT & PEPPER SHAKERS



d



e



f

| Item # | Description | Capacity | Min Order/ Case Pack |
|--|--|----------|----------------------|
| RESEALABLE SHAKERS –GLASS SHAKERS, S/S CLIP TOP | | | |
| d. *H15S&P | 1.5 oz Clear Glass, 7 x 4.5 x 6.5cm | 45 ml | 6 ea |
| MASON JAR SHAKERS–GLASS SHAKERS, S/S TOP | | | |
| e. *H475S&P | 4.75 oz Clear Glass, 7.5 x 5.5 x 8.5cm | 140 ml | 6 ea |
| REPLACEMENT PARTS & ACCESSORIES | | | |
| H475T | Stainless Steel Top for H475S&P | – | 12 ea |
| MINI MASON JAR SHAKERS–GLASS SHAKERS, S/S TOP | | | |
| f. *C170-12 | 1.5 oz Clear Glass, (Pack of 12) 5 x 4 x 6.5cm | 45 ml | 1 pk / 4 pk |
| REPLACEMENT PARTS & ACCESSORIES | | | |
| H475ST | Stainless Steel Solid Top fot H475S&P | – | 12 ea |

SHAKE...SHAKE... SHAKE THEM UP!



| Item # | Description | Capacity | Min Order/ Case Pack |
|---|--|----------|-------------------------|
| PANELED GLASS SHAKERS-S/S TOP | | | |
| a. | 150S&P-2 1 oz Shaker with Top (150T) | 30 ml | 24 ea |
| b. | 155S&P-2 2 oz Shaker with Top (150T) | 60 ml | 24 ea |
| c. | 156S&P-2 3 oz Shaker with Top (156T) | 90 ml | 24 ea |
| SQUARE GLASS SHAKERS-S/S TOP | | | |
| d. | 154S&P-2 2 oz Shaker with Top (154T) | 60 ml | 24 ea |
| ROUND GLASS SHAKERS-S/S TOP | | | |
| e. | 132S&P-2 3 oz Shaker with Top (132T) | 90 ml | 24 ea |
| EIFFEL TOWER CLEAR GLASS SHAKERS-CHROME PLATED TOPS† | | | |
| f. | 83S&P 1 oz Shaker with Top (83T) Fine multi hole tops | 30 ml | 24 ea |
| | 83S 1 oz Shaker with Top Fine single hole tops | 30 ml | 24 ea |
| | 83P 1 oz Shaker with Top Coarse multi hole pepper tops | 30 ml | 24 ea |
| NOSTALGIA GLASS SHAKERS-STAINLESS STEEL TOPS | | | |
| g. | 163S&P-2 1.5 oz Shaker with Top (163T) | 45 ml | 24 ea |
| CUBE GLASS SHAKERS-CHROME PLATED ABS TOP† | | | |
| h. | 30S&P 0.5 oz Shaker with Top (83T) | 15 ml | 24 ea |
| REPLACEMENT PARTS & ACCESSORIES | | | |
| 83T1 | Single Hole Chrome Plated Metal Tops, for 83S&P, 83S & 83P | | 12 ea |
| 83T | Fine Multi Hole Top, Nickel Plated, for 30S&P & 83S&P | | 24 ea |
| 83TP | Coarse Multi Hole Pepper Top, Nickel Plated, for 83S&P | | 24 ea |
| 163T | Stainless Steel Top for 163S&P-2 | | 24 ea |

† Hand wash only





SALT & PEPPER MILL SET



Our new 18cm Stainless Steel salt & pepper mill set is the perfect addition to the tabletop setting. These sets are perfect for grinding coarse peppercorns and salt.

- Set includes a salt & pepper mill for the tabletop
- Conveniently packaged for Cash & Carry
- Manufacturer's Lifetime Warranty (Ceramic Grinding Mechanism)
- Handwash only

ACRYLIC SALT & PEPPER MILL AND SHAKER COMBO

Upgrade your tabletop with our new acrylic salt & pepper mill combo. This is great for shaking salt or grinding coarse pepper corns.

- Single mill with a shaker and grinder mill combo
- Conveniently packaged for Cash & Carry
- Manufacturer's Lifetime Warranty (Ceramic Grinding Mechanism)
- Handwash only



NEW



d

| Item # | Description | Capacity | Min Order/ Case Pack |
|---|--|---------------|----------------------|
| SALT & PEPPER MILLS, SET OF 2 - STAINLESS STEEL, ACRYLIC | | | |
| a. 10924 | 1.5oz Salt and Pepper Mill Set, 5.5cm dia x 13cm | 45 ml | 1 set / 6 sets |
| b. 11689 ▶ | 4 oz Salt and Pepper Set, 6.5cm dia x 18cm | 120 ml | 1 set / 6 sets |
| SALT & PEPPER MILLS, SET OF 2 - BLACK AND WHITE, PLASTIC | | | |
| c. 10925 | 1.5oz Salt and Pepper Set, 5.5cm dia x 13cm | 45 ml | 1 set / 6 sets |
| SALT SHAKER & PEPPER MILL COMBINATION - ACRYLIC | | | |
| d. 11832 ▶ | Salt & Pepper Mill Combo Clear 6.5 x 5 x 19cm Acrylic, 30ml Shaker and 75ml Mill | 30 ml / 75 ml | 1 ea / 6 ea |
| WOOD PEPPER MILLS - MAHOGANY FINISH† | | | |
| e. PM1918 | 46cm Pepper Mill | | 1 ea / 12 ea |



Scan code to view a video on our Salt & Pepper Combo Mill.



Durable, forged steel mechanism to withstand daily use



e



a



b

AUTHENTIC COLLECTION™

- Eco-friendly recycled green glass
- Glass bottles are dishwasher safe
- Tops are hand wash only



| Item # | Description | Capacity | Min Order/ Case Pack |
|---|--|----------|-------------------------|
| AUTHENTIC COLLECTION™ – RECYCLED GREEN GLASS | | | |
| a. 6619 | Bottles, 6oz with Pourers (599P) | 355 ml | 12 ea |
| b. 6618 | Salt & Pepper Shakers, (2) 4 oz with Tops (163T) | 120 ml | 24 ea |

CONDIMENT JAR

| Item | Description | Capacity | Min Order/ Case Pack |
|---|---|----------|-------------------------|
| GLASS CONDIMENT JAR SET – STAINLESS STEEL* | | | |
| c. *357 | 6 oz Condiment Jar Set, Includes: Glass Jar, Stainless Steel Lid and Spoon | 180 ml | 1 ea / 48 ea |

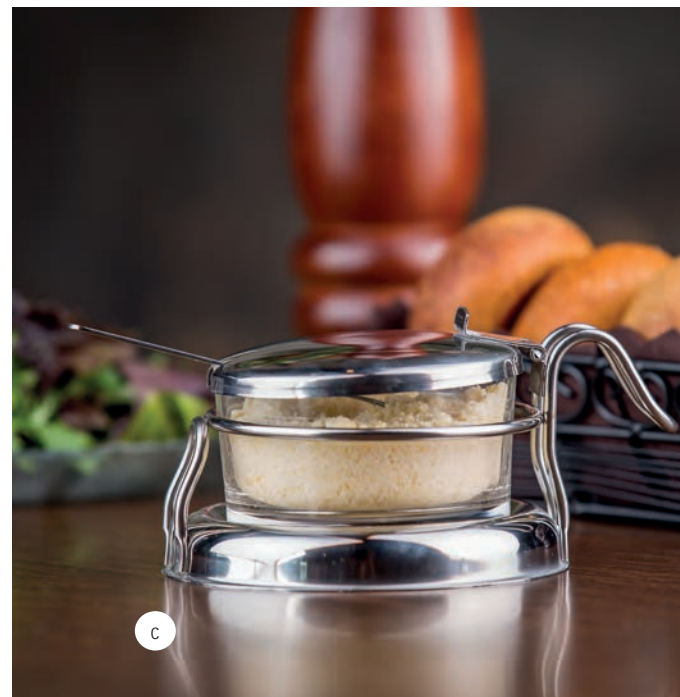

c



GETTING SPICY WITH IT

Use our shakers to spice up your pizza service



| Item # | Description | Capacity | Min Order/ Case Pack |
|--|---|----------|-------------------------|
| SWIRL BPA-FREE TRITAN® PLASTIC SHAKERS—CHROME PLATED METAL TOPS | | | |
| a. | P260 6 oz, Perforated Top, 7cm dia x 9cm | 180 ml | 24 ea |
| b. | P260SL 6 oz, Slotted Top, 7cm dia x 9cm | 180 ml | 24 ea |
| SWIRL GLASS SHAKERS—CHROME PLATED METAL TOP | | | |
| c. | 260 6 oz, Perforated Top, 7cm dia x 9cm | 180 ml | 36 ea |
| d. | 260SL 6 oz, Slotted Top, 7cm dia x 9cm | 180 ml | 36 ea |
| FLUTED GLASS, STAINLESS STEEL TOPS | | | |
| *800-4 | 12 oz, Fluted Perforated Shakers, Pack of 4, 8cm dia x 14.5cm | 355 ml | 1 pk |
| e. | 55S-4 12 oz, Fluted Centre Pour Shaker, Pack of 4, 8cm dia x 15cm | 355 ml | 1 pk |
| f. | P55S 12 oz, Swirl Shaker Center Pour Top, 7.5cm dia x 14.5cm | 355ml | 24 ea |
| g. | P57S 12 oz, Fluted Shaker Side Flap Top, 7.5cm dia x 14.5cm | 355ml | 24 ea |
| *C57S-4 | 12 oz, Shaker with Side Flap Top, Pack of 4, 7.5cm dia x 14.5cm | 355 ml | 4 pk |
| FLUTED BPA FREE TRITAN®, PLASTIC TOPS | | | |
| h. | P800BK 12 oz Shaker with Perforated Top, Black (4mm holes) | 355 ml | 24 ea |
| BPA FREE TRITAN®, STAINLESS STEEL TOPS | | | |
| i. | P800 12 oz Shaker with Perforated Top (4mm holes) | 355 ml | 24 ea |

* Cash & Carry item

VERSA RACK™



- Keep tabletops organised while saving space and labour
- Holds a variety of condiments
- Each features a merchandising ring that functions as a handle for easy carrying to and from the table

| Item # | Description | Min Order/ Case Pack |
|---|-------------------------------------|-------------------------|
| VERSA RACK™ – BLACK POWDER COATED METAL | | |
| a. | BKDIA595 16.5cm dia x 25.5cm, Black | 2 ea |
| b. | BKDIA728 20.5cm dia x 25.5cm, Black | 2 ea |
| TOWEL HOLDER & CADDY – BLACK POWDER COATED METAL | | |
| c. | 10263 25.5cm x 15cm x 31cm | 1 ea |

TABLE SACHET HOLDERS



- Our wide range of table sachet holders are a simple, stylish and hygienic way to serve pre-portioned condiment sachets or sugar packets
- Available in a variety of materials, sizes and styles to fit any décor

| Item # | Description | Min Order/ Case Pack |
|--|--|-------------------------|
| PREMIUM TABLE SACHET HOLDERS–STAINLESS STEEL OR POWDER COATED | | |
| d. | 1155 5cm dia x 7cm, Round, Brushed Stainless Steel | 1 ea / 12 ea |
| e. | 1157 8 x 6.5 x 4.5cm, Rectangular, Brushed Stainless Steel | 1 ea / 12 ea |
| f. | BK155 5cm dia x 6.5cm, Round, Black Powder Coated | 12 ea |
| ASSORTED TABLE SACHET HOLDERS* | | |
| g. | *C56W 8.5 x 6.5 x 5cm, White, Polystyrene (6 per Pack) | 1 ea / 6 ea |
| h. | *10308 8.5 x 6.5 x 5cm, Clear, Polystyrene (6 per Pack) | 1 ea / 6 ea |
| i. | 56B 8 x 6 x 5cm, Black, Polystyrene (PS) | 24 ea |
| | 56C 8 x 6 x 5cm, Clear, Polystyrene (PS) | 24 ea |
| | *10309 8.5 x 6.5 x 5cm, Black, Polystyrene (6 per Pack) | 1 ea / 6 ea |



20.5cm external dia

PAPER TOWEL HOLDER & CONDIMENT CADDY



- Provide an attractive solution for dispensing universal low-fold and tall-fold napkins
- One-at-a-time dispensing for any size table



Shown with our Squeeze Bottles (not included)

Stylish solution for room service tea and coffee serving

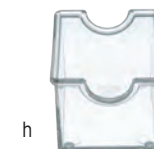

g

SERVING SOLUTIONS WITH EVERY MEAL

Whether you're serving up elegant appetizers or you're looking for a durable, fail-safe solution, TableCraft has a variety of serving options to help your operation to be more efficient. Choose from a variety of materials, sizes, and colours to create a custom look for every meal services' operational needs.



APPETISERS AND SIDE SERVERS | 88

| | |
|------------------------------------|----|
| Mini Paellas & Braziers..... | 88 |
| Mini Servers..... | 88 |
| Mini Casserole..... | 88 |
| Tri-Ply Tabletop Mini Servers..... | 88 |
| Kadai Dishes | 89 |
| Sheet Pans, Pie Pans..... | 90 |
| Taco Taxi™ Servers..... | 91 |
| Fajita Tower | 91 |
| Sauce Cups | 92 |
| Handled Side Server | 93 |
| Fry Cups | 93 |
| Sauce Boats | 93 |
| Cast Iron Servers | 94 |
| Cast Iron Underliners..... | 95 |
| Sizzle Platter Set | 95 |

SERVING COLLECTIONS | 97

| | |
|------------------------------|-----|
| Brickhouse Collection™ | 97 |
| Lattice Collection™ | 98 |
| Acacia Collection™ | 101 |

SERVING BASKETS | 103

| | |
|--|-----|
| Handwoven Baskets..... | 103 |
| Ridal Collection™ | 103 |
| Artisan Collection™ | 104 |
| Parisian Collection™ | 104 |
| Bouclé Collection™ | 105 |
| Delta Collection™ | 105 |
| Petal Collection™ | 105 |
| Classic Plastic Baskets and Platters | 106 |



Our Pie Pan servers are great and convenient for cooking and serving all in one pan. From casual dining to quick serve restaurants.

See page 90 for these and more serving options.



MINI SERVERS

- Perfect for an upscale table display and side serving
- 18/8 Interior with 18/0 base plate
- Single ply with clad base



MINI CASSEROLE

- Perfect presentation for individual soups, mac and cheese, or sides
- Lid allows vessel to stack perfectly to conserve space and keep covered



Lids designed to stack for presentation and storage (lids and casseroles sold separately)



MINI PAELLAS & BRAZIER

- Perfect for single-serve tapas or paella
- Cook & serve all-in-one
- Also a unique serving vessel for other cuisines and desserts



| Item # | Description | Capacity | Min Order/ Case Pack |
|---|--|----------|-------------------------|
| MINI PAELLA – STAINLESS STEEL | | | |
| a. 10289 | 4½oz Mini Paella Pan, 12cm dia x 2cm H 16cm dia with handles | 135ml | 1 ea / 12 ea |
| b. 10290 | 6½oz Mini Paella Pan, 15cm dia x 2cm H 19cm dia with handles | 190ml | 1 ea / 12 ea |
| MINI BRAZIER – STAINLESS STEEL | | | |
| 10291 | 12oz Mini Brazier with Handles, 12.5cm dia x 3.5cm H 18cm dia with handles | 355ml | 1 ea / 12 ea |
| c. 10292 | 16oz Mini Brazier with Handles, 15cm dia x 3.5cm H 20.5cm dia with handles | 475ml | 1 ea / 12 ea |
| d. 846 | 17oz Rectangular Mini Roast Pan, 15 x 9.5 x 5cm, 19cm width with Handles | 500ml | 1 ea / 6 ea |
| e. 833 | 14oz Square Mini Roaster with Handles, 11.5 x 11.5 x 5cm, 16cm width with Handle | 415ml | 1 ea / 12 ea |
| f. 850 | 26oz Square Mini Roast Pan, 14 x 14 x 5.5cm, 18cm width with Handles | 770ml | 1 ea / 12 ea |
| MINI CASSEROLE – STAINLESS STEEL | | | |
| g. 10303 | 16oz, Round with Handles, 12.5cm dia x 5cm 14.5cm dia with Handles (Lid Sold Separately) | 500ml | 1 ea / 12 ea |

TRI-PLY TABLETOP MINI SERVER

- Bring style to your serving presentation with this high quality mini server
- Versatile option: cook and serve in the same dish
- 18/8 Stainless Steel interior, 18/0 Stainless Steel exterior and aluminium core
- Lids sold separately



To view our collection of full size Tri-Ply cookware, see page 10

| Item # | Description | Capacity | Min Order/ Case Pack |
|--|---|----------|-------------------------|
| TRI-PLY TABLETOP MINI SERVERS – STAINLESS STEEL | | | |
| a. CW7000 | Casserole Server, 16cm dia x 6.5cm, 23cm dia with Handles | 1.1 L | 1 ea / 10 ea |
| b. CW7000LM | Glass Lid for CW7000, 16cm dia (sold separately) | | 1 ea / 20 ea |
| c. CW7000L | Lid for CW7000, 16cm dia (sold separately) | | 1 ea / 20 ea |

KADAI DISHES



| Item # | Description | Capacity | Min Order/ Case Pack |
|---|--|----------|-------------------------|
| KADAI DISHES – STAINLESS STEEL | | | |
| c. 839 | Kadai Bowl, 13.5cm dia x 5.5cm, 17cm dia with Handles | 590ml | 1 ea / 6 ea |
| d. 840 | Kadai Bowl, 15.5cm dia x 7cm, 20cm dia with Handles | 830ml | 1 ea / 6 ea |
| KADAI DISHES – COPPER PLATED STAINLESS STEEL | | | |
| e. 848 | Handled Handi Dish, Mirror Finish with Hammered Pattern, 16cm dia x 5.5cm, 18.5cm dia with Handles | 890ml | 1 ea / 6 ea |
| HANDI DISHES – COPPER PLATED STAINLESS STEEL | | | |
| f. 843 | Handi Dish, Mirror Finish with Hammered Pattern, 13cm dia x 5.5cm | 890ml | 1 ea / 12 ea |



SERVING SOLUTIONS
PAELLA, BRAZILERS, KADAI AND TRI-PLY TABLETOP

SHEET PAN & PIE PAN SERVERS

- Not just for baking; Sheet Pan Servers offer an alternative to serving large portions of chicken, smokehouse barbeque, or burgers
- Our Pie Pan servers are great for cooking and serving all in one pan! Ideal for baking pies, cakes and other desserts and entrees or for serving sandwiches, paninis and sides!
- Great for family style serving, catered events, or in high volume service
- Stainless Steel servers are dishwasher safe; Aluminium servers are hand wash recommended

SIDE PRESENTATIONS



Cost-effective way to dress your tabletop

NEW

Etched Weave Pattern gives a nostalgic nod to the plastic trays of the past

Stainless Steel makes this tray stylish and modern



| Item # | Description | Min Order/ Case Pack |
|---|--|----------------------|
| SHEET PAN SERVERS | | |
| a. 913A | Sheet Pan, 19 GA Aluminium, Shiny Finish 33 x 24 x 3cm | 1 ea / 12 ea |
| 913AS | Sheet Pan, 23 GA Aluminised Steel, Matte Finish 33 x 24 x 3cm | 1 ea / 12 ea |
| b. 1006AS | Sheet Pan, 23 GA Aluminised Steel, Matte Finish 25.5 x 15 x 2.5cm | 1 ea / 12 ea |
| PIE PAN SERVERS | | |
| ALUMINIUM (Hand wash recommended) | | |
| c. 11655 ▶ | 15cm dia x 2.5cm (0.7 mm Thickness) | 1 ea / 12 ea |
| d. 10545 | 23cm dia x 2.5cm (0.7mm thickness) | 1 ea / 12 ea |
| e. 10546 | 26cm dia x 2cm (0.7mm thickness) | 1 ea / 12 ea |
| STAINLESS STEEL (Dishwasher safe) | | |
| f. 11656 ▶ | 15cm dia x 2.5cm (0.7 mm Thickness) | 1 ea / 12 ea |
| g. 10547 | 23cm dia x 2.5cm (0.5mm thickness) | 1 ea / 12 ea |
| 10548 | 26cm dia x 2cm (0.5mm thickness) | 1 ea / 12 ea |
| SERVING TRAY | | |
| STAINLESS STEEL WITH WEAVE PATTERN | | |
| h. 20005 | Better Burger Collection™ Serving Tray, 25.5 x 18 x 1.5cm | 1 ea / 12 ea |

TACO TAXI™

- Prep and serve your hard or soft shell taco creations in style
- Perfectly designed to cradle your stuffed creations
- Stainless Steel servers are safe for temperatures up to 260°C



Keeps your tacos upright and easy to eat!



| Item # | Description | Min Order/ Case Pack |
|--|--|-------------------------|
| TACO TAXI™ SERVERS – STAINLESS STEEL WIRE | | |
| TRW12 | Holds 1-2 Tacos, 9 x 5.5 x 4cm | 1 ea / 12 ea |
| a. TRW23 | Holds 2-3 Tacos, 14 x 5.5 x 4cm | 1 ea / 12 ea |
| b. TRW34 | Holds 3-4 Tacos, 19 x 5.5 x 4cm | 1 ea / 12 ea |
| TACO TAXI™ SERVERS – STAINLESS STEEL BRUSHED FINISH, SOLID | | |
| TRS12 | Holds 1-2 Tacos, 9 x 5.5 x 4cm | 1 ea / 12 ea |
| TRS23 | Holds 2-3 Tacos, 14 x 5.5 x 4cm | 1 ea / 12 ea |
| c. TRS34 | Holds 3-4 Tacos, 19 x 5.5 x 4cm | 1 ea / 12 ea |
| TACO TAXI™ SERVERS – STAINLESS STEEL BRUSHED FINISH, CIRCLE PATTERN | | |
| TRSP12 | Holds 1-2 Tacos, 9 x 5.5 x 4cm | 1 ea / 12 ea |
| TRSP23 | Holds 2-3 Tacos, 14 x 5.5 x 4cm | 1 ea / 12 ea |
| d. TRSP34 | Holds 3-4 Tacos, 19 x 5.5 x 4cm | 1 ea / 12 ea |
| FAJITA TOWER – BLACK POWDER COATED METAL | | |
| e. FTR1711 | Rack with Rubber Feet, Black Powder Coated Metal, 28.5 x 20.5 x 45cm. (19.2cm dia Shelves) | 1 ea / 6 ea |
| FAJITA ACCESSORY | | |
| f. 557TCH | Charcoal Tortilla Server, 19.5cm dia x 4.5cm (fits FTR1711) | 1 ea / 12 ea |
| TIERED RISER – BLACK POWDER COATED METAL | | |
| g. BKP4 | Four Tiered Stand, 23cm dia x 37cm h | 1 ea / 4 ea |



Not just for fajitas!
Perfect for any stackable serving.



TIERED RISER

Use our Four-Tiered Stand (BKP4) with the Pulito Pasta Bowls (not included) to display fresh fruit, salad and fajita toppings, and more.

RAMEKINS AND SAUCE CUPS



NEW

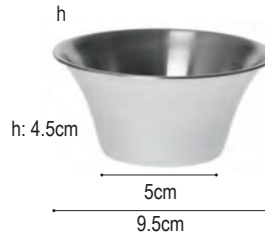
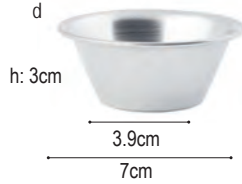
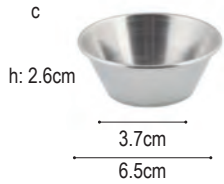
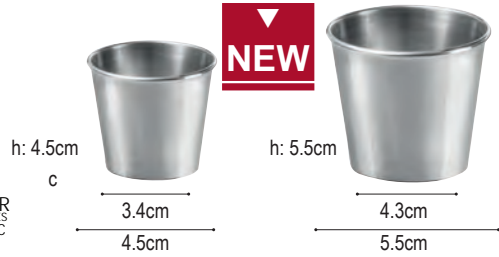

| Item # | Description | Capacity | Min Order/ Case Pack |
|---|---|----------|----------------------|
| ROUND SAUCE CUPS – STAINLESS STEEL | | | |
| a. | 12159 ▶ 1.7oz, 4.5cm dia x 4.5cm | 50ml | 24 ea |
| b. | 12160 ▶ 3.3oz, 5.5cm dia x 5.5cm | 100ml | 24 ea |
| c. | 5066 1.5oz, 6.5cm dia x 2.6cm | 45ml | 12 ea |
| d. | 5068 2oz, 7cm dia x 3cm | 60ml | 72 ea |
| e. | 5067 2.5oz, 6cm dia x 4.3cm | 75ml | 12 ea |
| f. | 240010 3oz, Tall, Flared, 6.5cm dia x 4cm | 90ml | 12 ea |
| g. | 5063 4oz, Flared, 8cm dia x 4cm | 120ml | 12 ea |
| h. | 5064 6oz, Flared, 9.5cm dia x 4.5cm | 180ml | 12 ea |
| i. | 5071 3oz, 7cm dia x 4cm | 90ml | 12 ea |
| j. | 5072 4oz, 7.5cm dia x 5cm | 120ml | 12 ea |
| k. | 5073 6oz, 8cm dia x 5.5cm | 180ml | 12 ea |
| BRICKHOUSE COLLECTION™ – STAINLESS STEEL | | | |
| l. | GRSS1 1.5oz, 6cm dia x 2.5cm | 45ml | 12 ea |
| m. | GRSS2 2.5oz, 5.5cm dia x 4.5cm | 75ml | 12 ea |
| n. | GRSS3 3oz, 7cm dia x 4.5cm | 90ml | 12 ea |

FRY CUPS



• Serve your starters in style with these stainless steel snack bowls

| Item # | Description | Capacity | Min Order/ Case Pack |
|--------------------------------------|---|----------|-------------------------|
| FRY CUPS – STAINLESS STEEL | | | |
| a. | AC885S Round Server, Brushed Finish, 8.5cm dia x 8.5cm | 415ml | 1 ea / 12 ea |
| b. | AC885H Round Server, Hammered Finish, 8.5cm dia x 8.5cm | 415ml | 1 ea / 12 ea |
| SAUCE BOATS – STAINLESS STEEL | | | |
| c. | 9803 3oz Stackable, 11 x 6.5 x 5cm | 90ml | 1 ea / 24 ea |
| d. | 9805 5oz Stackable, 13 x 6.5 x 6cm | 150ml | 1 ea / 12 ea |
| | 9808 8oz Stackable, 15 x 7.5 x 7cm | 240ml | 1 ea / 12 ea |
| | 9812 12oz Stackable, 16 x 9 x 7cm | 355ml | 1 ea / 12 ea |



a

b



c

d

SAUCE BOATS



- Portion-sized sauce boats, in a variety of sizes
- Stackable design for easy storage with a brushed finish to hide fingerprints



200ml

j

300ml

k

400ml

l

SIDE SERVERS



Stainless Steel Side Servers are perfect for portioned control sides. These side servers create a casual dining experience and are perfect for serving your sides such as potatoes, vegetables, and mac and cheese.

- Great for indoor or outdoor service
- Stainless Steel construction
- Easy to clean, dishwasher safe

| Item # | Description | Capacity | Min Order/ Case Pack |
|--|--|----------|-------------------------|
| HANDLED SIDE SERVER - STAINLESS STEEL | | | |
| j. | 11435 ▶ 7.5oz Side Server, 17 x 8 x 4.5cm | 200ml | 1 ea / 12 ea |
| k. | 11436 ▶ 10oz Side Server, 19 x 9 x 4.5cm | 300ml | 1 ea / 12 ea |
| l. | 11437 ▶ 12oz Side Server, 19.5 x 9.5 x 5cm | 400ml | 1 ea / 12 ea |





CAST IRON COOKWARE



a



b



d



e

CAST IRON UNDERLINERS

• Protect tables and countertops from hot cast iron

Assorted Ramekins that fit platters (sold separately):

- RAM2FBKEU & RAM2FWEU
- RAM2WEU & RAM2BKEU
- RAM3WEU
- RAM3RWEU, RAM3RREU, RAM3RBKEU, RAM3RXEU
- RAM4RWEU, RAM4RBKEU
- 5063
- 5073



f

Platter #10746 and Oval Au Gratin #CW30100 (shown on page 95) fit these serving boards



g

10709 & 10710:
23.5 x 9.5cm Oval Cut-Out
& (4) 5.5cm Circular Cutouts

CAST IRON WORKS

- Pre-seasoned, naturally non-stick & easy to clean
- Simple solution for cooking and serving from one dish
- Durable and dependable, a good option for extended use
- For more detailed care and use instructions see page 137 in back of book
- Safe to -17°C

| Item # | Description | Capacity | Min Order/ Case Pack |
|---------------------------|--|----------|----------------------|
| CAST IRON COOKWARE | | | |
| a. | *CW30152 Fajita Platter, 19cm dia x 3.5cm, 26cm dia with Handles | 710ml | 1 ea / 6 ea |
| b. | *CW30114 Square Pan, 27 x 27 x 5.5cm, 33cm width with Handles | 2.6 L | 1 ea / 4 ea |
| c. | *CW30116 Wok, 36.5 dia x 11.5cm, 44.5cm dia with Handles | 5.7 L | 1 ea / 4 ea |
| d. | *CW30118 Pizza Pan, 34.5cm dia x 2cm, 44.5cm dia with Handles | — | 1 ea / 4 ea |

| Item # | Description | Min Order/ Case Pack |
|-----------------------|-------------------------------|----------------------|
| TORTILLA PRESS | | |
| e. | 10711 20cm dia Tortilla Press | 1 ea / 4 ea |

| Item # | Description | Min Order/ Case Pack |
|--|------------------------------------|----------------------|
| FAJITA SERVING BOARDS – ACACIA WOOD | | |
| f. | 10710 Oval, 43.5 x 31 x 2cm | 1 ea / 12 ea |
| g. | 10709 Rectangular, 47 x 22.5 x 2cm | 1 ea / 12 ea |

| Item # | Description | Capacity | Min Order/ Case Pack |
|----------------------------------|--|----------|-------------------------|
| ROUND CASSEROLES WITH LID | | | |
| a. | CW30110 10cm dia x 8.5cm, 13cm dia w/ Handles | 240ml | 1 ea / 4 ea |
| | CW30148 13cm dia x 9.5cm, 18cm dia w/ Handles | 530ml | 1 ea / 6 ea |
| OVAL CASSEROLES WITH LID | | | |
| b. | CW30112 12.5 x 9.5 x 8cm, 15.5cm dia w/ Handles | 240ml | 1 ea / 4 ea |
| OVAL AU GRATIN | | | |
| c. | CW30100 21.5 x 15.5 x 6.5cm, 27cm dia w/ Handles | 710ml | 1 ea / 6 ea |
| ROUND SKILLETS | | | |
| | CW30122 10cm dia x 3.5cm, w/ 9.5cm Handle | 90ml | 1 ea / 6 ea |
| | CW30124 14.5cm dia x 3cm, w/ 12cm Handle | 240ml | 1 ea / 6 ea |
| d. | CW30108 14cm dia x 4cm, w/ 9cm Handle | 355ml | 1 ea / 6 ea |
| ROUND SERVERS | | | |
| e. | CW30102 12.5cm dia x 4cm, 16.5cm dia with Handles | 240ml | 1 ea / 6 ea |
| | CW30104 13.5cm dia x 4.5cm, 18cm dia with Handles | 355ml | 1 ea / 6 ea |
| | CW30142 16cm dia x 4cm, 20.5cm dia with Handles | 530ml | 1 ea / 6 ea |
| | CW30140 18.5cm dia x 5cm, 23cm dia with Handles | 830ml | 1 ea / 6 ea |
| | CW30152 19cm dia x 3.5cm, 26cm dia with Handles | 710ml | 1 ea / 6 ea |
| SQUARE SERVERS | | | |
| f. | CW30150 12.5 x 12.5 x 4cm, 17.5cm width with Handles | 355ml | 1 ea / 6 ea |
| SIZZLE PLATTER | | | |
| g. | 10746 Oval, 23.5 x 17 x 1.5cm | — | 1 ea / 6 ea |
| KETTLE | | | |
| h. | CW30151 13cm dia x 8cm | 475ml | 1 ea / 6 ea |
| CAST IRON LINERS | | | |
| i. | 10764 Acacia Wood Underliner for Cast Iron Oval Skillet (10746) | — | 1 ea / 40 ea |
| j. | FSR3 Cast Iron Sizzle Platter Set, Wooden Liner and Glove, 40.5 x 23 x 4cm | — | 1 ea / 6 ea |

Protect tables and countertops from hot cast iron



Includes a heat-safe mitt for easy and safe transportation to the table



WELCOME TO THE BRICKHOUSE COLLECTION™

- Perfect for indoor and outdoor dining;
fast-casual serving solutions
- Available in a variety of styles and sizes;
for serving shareable sides, entrees or
beverage options



NEW



| Item # | Description | Capacity | Min Order/ Case Pack |
|---|---|----------|-------------------------|
| BRICKHOUSE COLLECTION™ – STAINLESS STEEL WITH EMBOSSED BRICK PATTERN | | | |
| MUGS | | | |
| a. | 11659 ▶ Round Mug, 12 x 9 x 9cm Stainless Steel (200 Series) | 500ml | 1 ea / 12 ea |
| b. | 11660 ▶ Round Mug, 14.5 x 10 x 10cm Stainless Steel (200 Series) | 700ml | 1 ea / 12 ea |
| PLATTERS | | | |
| c. | GPSS8 Round, 21cm dia x 4.5cm | 945ml | 1 ea / 12 ea |
| | GPSS10 Round, 27.5cm dia x 4cm | 1.5 L | 1 ea / 12 ea |
| d. | GPSS96 Oval, 25 x 15 x 6cm | 1.2 L | 1 ea / 12 ea |
| e. | GPSS129 Oval, 31 x 22 x 6cm | 3 L | 1 ea / 12 ea |
| | GPSS89 Rectangular, 28 x 18.5 x 3cm | 1.4 L | 1 ea / 12 ea |
| f. | GPSS90 Rectangular, 25 x 17 x 4.5cm | 1.5 L | 1 ea / 12 ea |
| | GPSS120 Rectangular, 31 x 23.5 x 4.5cm | 2.8 L | 1 ea / 12 ea |
| PAILS | | | |
| g. | GTSS33 Round, 8cm dia x 8cm | 265ml | 1 ea / 12 ea |
| h. | GTSS44 Round, 11cm dia x 9.5cm | 490ml | 1 ea / 12 ea |
| i. | GTSS87 Round, 21cm dia x 18cm | 4.7 L | 1 ea / 4 ea |
| CADDY | | | |
| j. | GPSSCADDY Rectangular, 27.5 x 21 x 12cm | — | 1 ea / 4 ea |
| FRY CUPS | | | |
| k. | GTSS28 Slanted Round, 8.5cm dia x 11.5cm | 280ml | 1 ea / 12 ea |
| | GTSS375 Slanted Round, 9.5cm dia x 12.5cm | 295ml | 1 ea / 12 ea |
| l. | GTSS31 Round, 9cm dia x 9cm | 385ml | 1 ea / 12 ea |
| | GTSS45 Round, 10cm dia x 12cm | 680ml | 1 ea / 12 ea |
| m. | GTSS4 Tapered Square, 10cm dia x 9.5cm | 590ml | 1 ea / 12 ea |
| RAMEKINS | | | |
| n. | GRSS1 Round, 6cm dia x 2.5cm | 45ml | 12 ea |
| o. | GRSS2 Round, 5.5cm dia x 4.5cm | 75ml | 12 ea |
| p. | GRSS3 Round, 7cm dia x 4.5cm | 90ml | 12 ea |





THE LATTICE COLLECTION™

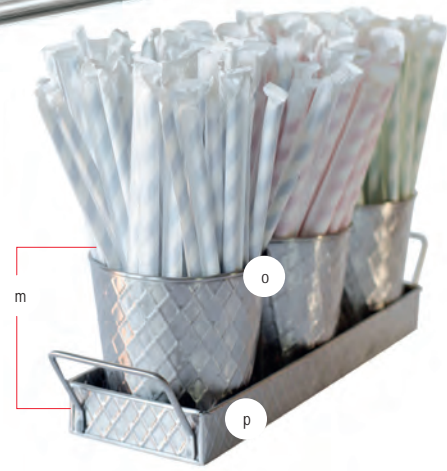

NEW



| Item # | Description | Capacity | Min Order/ Case Pack |
|--|--|----------|-------------------------|
| LATTICE COLLECTION™ – STAINLESS STEEL WITH EMBOSSED BASKETWEAVE PATTERN | | | |
| MUGS – 200 SERIES STAINLESS STEEL | | | |
| a. | 11657 ▶ Round Mug, 12 x 8.5 x 9.5cm | 400ml | 1 ea / 12 ea |
| b. | 11568 ▶ Round Mug, 13.5 x 10 x 10cm | 700ml | 1 ea / 12 ea |
| PLATTERS | | | |
| c. | 10034 Round, 20.5 dia x 4cm | 950ml | 1 ea / 12 ea |
| d. | 10035 Round, 26.5 dia x 4cm | 1.9 L | 1 ea / 12 ea |
| e. | 10036 Oval, 24 x 15 x 5cm | 1.2 L | 1 ea / 12 ea |
| f. | 10037 Oval, 30.5 x 23 x 5cm | 3 L | 1 ea / 12 ea |
| g. | 10038 Rectangular, 24 x 16.5 x 4cm | 1.5 L | 1 ea / 12 ea |
| h. | 10039 Rectangular, 30.5 x 23 x 4cm | 2.8 L | 1 ea / 12 ea |
| PAIL | | | |
| i. | 10041 Round, 10 dia x 9.5cm | 490ml | 1 ea / 12 ea |
| FRY CUPS | | | |
| j. | 10042 Slanted Round, 9.5 dia x 12cm | 295ml | 1 ea / 12 ea |
| k. | 10043 Tapered Square, 10 x 10 x 9cm | 590ml | 1 ea / 12 ea |
| CADDY, SNACK SET & TRAY | | | |
| l. | 10040 Rectangular, 27 x 21.5 x 12cm | | 1 ea / 4 ea |
| m. | 10486 Four Piece Snack Set, Includes Tray (10488) & (3) 680ml Cups (10487) | | 1 ea / 12 ea |
| o. | 10487 Round Cup, 10.5cm dia x 10.5cm | 680ml | 1 ea / 12 ea |
| p. | 10488 Snack Tray, 36.5 x 11.5cm | | 1 ea / 12 ea |

LATTICE ENTERTAIN YOU

- Create a casual dining experience with our Lattice Collection™ Stainless Steel construction with an embossed basketweave pattern
- Available in a variety of styles and sizes; these pieces add a casual feel to your main dishes and shareable sides

NEW



i



e

j

a / b / c



Paddle sizes range from individual to family-style serving

d / e / f



g



i



j

ACACIA COLLECTION™



- Bring rustic charm to your table setting with these handcrafted serving pieces
- Choose from a wide range of boards all made from attractive natural wood
- Prior to using, hand wash your item and protect it with a light coating of mineral oil

| Item | Description | Min Order/ Case Pack |
|---------------------------------------|--|-------------------------|
| ACACIA WOOD WITH METAL BANDING | | |
| a. | 10076 Rectangular Paddle, 21 x 23cm with 12cm Handle | 1 ea / 6 ea |
| b. | 10077 Rectangular Paddle, 31 x 18cm with 12cm Handle | 1 ea / 6 ea |
| c. | 10078 Rectangular Paddle, 38.5 x 21.5cm with 12cm Handle | 1 ea / 6 ea |
| d. | 10079 Round Paddle, 25.5cm dia with 12cm Handle | 1 ea / 6 ea |
| e. | 10080 Round Paddle, 30.5cm dia with 12cm Handle | 1 ea / 6 ea |
| f. | 10081 Round Paddle, 35.5cm dia with 12cm Handle | 1 ea / 6 ea |



h

Nickel Plated Handles

| Item | Description | Min Order/ Case Pack |
|--|---|-------------------------|
| ACACIA WOOD WITH BRUSHED NICKEL ACCENTS | | |
| g. | ACAMBB1507 Display Bread Board with Metal Eyelet 38 x 18.5 x 1.5cm | 1 ea / 12 ea |
| h. | ACAMR2007 Rectangular Display Board, 43 x 18 x 1.5cm with 3cm Handles | 1 ea / 8 ea |
| i. | ACAMR14 Round Display Board, 35.5 x 1.5cm with 7.5cm Handle | 1 ea / 6 ea |
| END GRAIN SERVING BOARDS | | |
| j. | ACARD16 40.5cm dia x 4cm | 1 ea / 3 ea |

Harvested from nature; no two pieces are the same. Variation amongst sizes +/- 1.5cm

ACACIA COLLECTION™ SERVING BOARDS



| Item # | Description | Min Order/ Case Pack |
|--|-------------------------------------|-------------------------|
| RECTANGULAR SERVING BOARDS | | |
| 11291 | 30.5 x 20.5 x 2cm | 1 ea / 12 ea |
| a. 11294 | 35 x 24 x 2cm | 1 ea / 12 ea |
| 11295 | 45.5 x 30 x 2cm | 1 ea / 6 ea |
| SERVING BREAD BOARDS WITH HANDLES | | |
| b. 11296 | 24 x 24 x 2cm, with 11.5cm Handle | 1 ea / 12 ea |
| c. 11297 | 26 x 18.5 x 2cm, with 15cm Handle | 1 ea / 6 ea |
| ROUND & OVAL SERVING BREAD BOARDS | | |
| d. 11298 | 23cm dia x 2cm | 1 ea / 4 ea |
| e. 11299 | 30.5cm dia x 2cm | 1 ea / 4 ea |
| f. 11300 | 40.5 x 20.5 x 2cm | 1 ea / 6 ea |
| g. 11301 | 51 x 20.5 x 2cm | 1 ea / 6 ea |
| SERVING PADDLE BOARDS | | |
| 11292 | 40 x 15.5 x 1.5cm, with 11cm Handle | 1 ea / 8 ea |
| h. 11293 | 44 x 20.5 x 2cm, with 12cm Handle | 1 ea / 8 ea |

Harvested from nature; no two pieces are the same. Variation amongst sizes +/- 1.5cm





ACACIA COLLECTION™ SNACK TRAYS



Perfect for bread and cheeses, sliced pizzas or flatbreads, and other treats.

- Ergonomic handles for comfortable serving and hang hole for drying or storage
- Features recessed center to keep foods in place
- Conveniently packaged for Cash & Carry

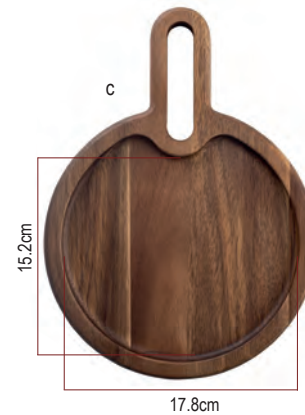

| Item # | Description | Min Order/ Case Pack |
|--------------------------------|--|-------------------------|
| ACACIA WOOD SNACK TRAYS | | |
| a. 11522 | Rectangular 23 x 14 x 2cm (7.5cm handle) | 1 ea / 8 ea |
| b. 11523 | Rectangular 30.5 x 14 x 2cm (7.5cm handle) | 1 ea / 8 ea |
| c. 11524 | Round 20.5cm dia x 2cm (7.5cm handle) | 1 ea / 8 ea |
| d. 11525 | Round 25.5cm dia x 2cm (9.5cm handle) | 1 ea / 8 ea |

Harvested from nature; no two pieces are the same. Variation amongst sizes +/- 1.5cm

| Item # | Description | Min Order/ Case Pack |
|---|---------------------------|-------------------------|
| RECTANGULAR NATURAL DISPLAY BASKETS – POLYPROPYLENE | | |
| a. 1188W | 35.5 x 25.5 x 7.5cm | 6 ea |
| 1189W | 41 x 28.5 x 7.5cm | 6 ea |
| 1192W | 45.5 x 31 x 7.5cm | 6 ea |
| NATURAL SERVING BASKETS – POLYPROPYLENE CASING, STEEL INTERIOR | | |
| 1175W | Round, 21.5cm dia x 5.5cm | 12 ea |
| b. 1171W | Oval, 17.5 x 13 x 5cm | 12 ea |
| 1174W | Oval, 23 x 15 x 5.5cm | 12 ea |
| 1176W | Oval, 26 x 16.5 x 9cm | 12 ea |
| c. 1177W | Round, 18cm dia x 5cm | 12 ea |

| Item # | Description | Min Order/ Case Pack |
|---|---|-------------------------|
| RIDAL COLLECTION™ BASKETS – POLYETHYLENE, HEAVY SOLID CORD, BLACK | | |
| d. M2475 | Round, 21cm dia x 8cm | 12 ea |
| e. M2474 | Oval, 23.5 x 16 x 8cm | 12 ea |
| M2485 | Rectangular, 30 x 22 x 7.5cm | 6 ea |
| f. M2489 | Rectangular, 42 x 30 x 9cm | 6 ea |
| g. M2493 | Rectangular for Display, 48 x 35.5 x 10cm | 6 ea |
| BROWN SERVING BASKETS – POLYETHYLENE, W/ENCASED STEEL SUPPORT WIRE | | |
| 1471 | Oval, 18 x 13.5 x 5cm | 12 ea |
| h. 1474 | Oval, 23 x 15.5 x 6cm | 12 ea |
| i. 1475 | Round, 22cm dia x 6cm | 12 ea |

NATURAL BASKETS



- Solid, heavy cord design for superior quality
- All purpose serving baskets provide the "homemade" touch to your table setting



RIDAL COLLECTION™ BASKETS



- Solid, heavy cord design for superior quality
- Heat lamp and microwave safe up to 65°C
- Microwaveable for limited reheat use



FROM ARTISAN, TO PARISIAN.

ARTISAN COLLECTION™ BASKETS



- Integrated ramekin holders fit 2oz / 60ml and 3oz / 90ml ramekins (not included)



| Item # | Description | Min Order/ Case Pack |
|---|---|-------------------------|
| ARTISAN COLLECTION™ BASKETS – BLACK POWDER COATED STEEL | | |
| a. BK171182* | Round with Integrated Ramekin Holders, 28.5 x 21 x 5cm | 1 ea / 6 ea |
| BK171372* | Oval with Integrated Ramekin Holders, 33.5 x 18.5 x 4.5cm | 1 ea / 6 ea |
| b. BK171172* | Square with Integrated Ramekin Holders, 28.5 x 19.5 x 5cm | 1 ea / 6 ea |
| BK17506 | Round, 15cm dia x 5cm | 1 ea / 6 ea |
| BK17508 | Round, 20cm dia x 5.5cm | 1 ea / 6 ea |
| c. BK17510 | Round, 25.5cm dia x 7.5cm | 1 ea / 6 ea |
| d. BK17409 | Oval, 23.5 x 16 x 5.5cm | 1 ea / 6 ea |
| BK17410 | Oval, 25.5 x 17 x 8cm | 1 ea / 6 ea |
| e. BK11709 | Oblong, 23 x 10 x 5cm | 1 ea / 6 ea |
| f. BK17209 | Rectangular, 23.5 x 16 x 6cm | 1 ea / 6 ea |
| PARISIAN COLLECTION™ BASKETS – BLACK POWDER COATED STEEL | | |
| g. 10820 | Round Wire Basket with Solid Bottom 15 x 15 x 5.5cm | 1 ea / 24 ea |
| h. 10821 | Round Wire Basket with Solid Bottom 20 x 20 x 6cm | 1 ea / 24 ea |
| i. 10822 | Oval Wire Basket with Solid Bottom 23 x 15 x 9cm | 1 ea / 24 ea |

*Ramekins Not Included



PARISIAN COLLECTION™ BASKETS



- Wire construction with solid bottoms for additional versatility



g



i



h

BLACK POWDER COATED METAL BASKETS

Providing an elegant and eye-catching way to serve bread and sides or display fruit and veggies.



BOUCLÉ COLLECTION™

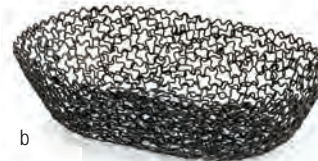

| Item # | Description | Min Order/ Case Pack |
|--|---|-------------------------|
| BOUCLÉ SERIES BASKETS – BLACK POWDER COATED STEEL | | |
| a. | BK37109 Rectangular Basket, 20cm x 11cm (4cm depth) | 1 ea / 6 ea |
| b. | BK37409 Oval Basket, 22cm x 14cm (5cm depth) | 1 ea / 6 ea |
| c. | BK37508 Round Basket, 19cm dia (5cm depth) | 1 ea / 6 ea |
| d. | BK37515 Round Basket, 15cm dia (5cm depth) | 1 ea / 6 ea |
| DELTA SERIES BASKETS – BLACK POWDER COATED STEEL | | |
| e. | 10462 15cm dia Round Basket, (5cm depth) | 1 ea / 6 ea |
| f. | 10463 20cm dia Round Basket, (5cm depth) | 1 ea / 6 ea |
| g. | 10464 25.5cm dia Round Basket, (8.5cm depth) | 1 ea / 6 ea |
| PETAL COLLECTION™ BASKETS – BLACK POWDER COATED METAL | | |
| h. | 10537 Rectangular, 22.5 x 15cm (6cm depth) | 1 ea / 6 ea |
| i. | 10534 Round, 15cm dia (6cm depth) | 1 ea / 6 ea |
| j. | 10535 Round, 20cm dia (5.5cm depth) | 1 ea / 6 ea |
| k. | 10536 Oval, 22.5 x 15cm (6cm depth) | 1 ea / 6 ea |

DELTA COLLECTION™



PETAL COLLECTION™

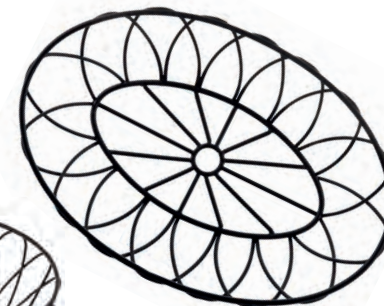



THE
CLASSIC.
OFTEN
REPLICATED...

OVAL PLASTIC BASKETS

- Heat lamp safe up to 65°C
- Max microwave 800 watts

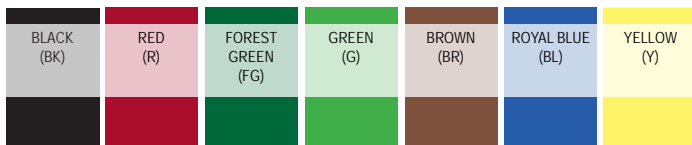

| Item # | Description | Min Order/ Case Pack |
|---|------------------|-------------------------|
| CLASSIC OVAL BASKETS – HIGH DENSITY POLYPROPYLENE, 23.5 X 15.5 X 5CM | | |
| 1074BK | Black | 36 ea |
| 1074BK-6 | Black, Pack of 6 | 1 pk / 6 pk |
| 1074BL | Royal Blue | 36 ea |
| 1074BR | Brown | 36 ea |
| 1074FG | Forest Green | 36 ea |
| 1074G | Green | 36 ea |
| a. 1074R | Red | 36 ea |
| 1074R-6 | Red, Pack of 6 | 1 pk / 6 pk |
| 1074Y | Yellow | 36 ea |
| JUMBO OVAL BASKETS – POLYPROPYLENE, 30 X 23 X 5CM | | |
| b. 1084BK | Black | 36 ea |
| 1084R | Red | 36 ea |
| CHICAGO PLATTER OVAL BASKETS – POLYPROPYLENE, 27 X 18.5 X 3.5CM | | |
| 1076BK | Black | 36 ea |
| c. 1076BR | Brown | 36 ea |
| 1076FG | Forest Green | 36 ea |
| 1076R | Red | 36 ea |
| SIDE ORDER OVAL BASKETS – HIGH DENSITY POLYETHYLENE, 20 X 13.5 X 5CM | | |
| 1071BK | Black | 36 ea |
| d. 1071R | Red | 36 ea |
| TEXAS PLATTER OVAL BASKETS – POLYPROPYLENE, 32.5 X 24 X 4CM | | |
| e. 1086BK | Black | 36 ea |
| 1086R | Red | 36 ea |

BASKETS AND PLATTERS

- Heat lamp safe up to 65°C
- Max microwave 800 watts



| Item # | Description | Min Order/ Case Pack |
|--|---------------------------|-------------------------|
| A LA CARTE OVAL PLATTER BASKETS – POLYPROPYLENE, 23.5 X 15 X 4CM | | |
| a. 1073BK | Black | 36 ea |
| 1073FG | Forest Green | 36 ea |
| 1073R | Red | 36 ea |
| GRANDE RECTANGULAR PLATTER BASKETS – POLYPROPYLENE, 27 X 18.5 X 3.5CM | | |
| b. 1077BK | Black | 36 ea |
| 1077BR | Brown | 36 ea |
| 1077R | Red | 36 ea |
| MÁS GRANDE RECTANGULAR PLATTER BASKETS – POLYPROPYLENE, 30 X 21.5 X 4CM | | |
| 1079BK | Black | 36 ea |
| c. 1079FG | Forest Green | 36 ea |
| 1079R | Red | 36 ea |
| ROUND SERVING BASKETS – HIGH DENSITY POLYPROPYLENE, 20.5CM DIA X 5CM | | |
| d. 1075BK | Black | 36 ea |
| 1075FG | Forest Green | 36 ea |
| 1075R | Red | 36 ea |
| ROUND DINER PLATTERS WITH BASE – POLYPROPYLENE (NSF) 23CM DIA | | |
| e. 15759BK | Black, 23cm dia x 4.5cm | 12 ea |
| 157510BK | Black, 26.5cm dia x 5.5cm | 12 ea |
| 157510R | Red, 26.5cm dia x 5.5cm | 12 ea |
| ROUND PLATTERS – POLYPROPYLENE (NSF) 23CM DIA | | |
| f. 13759BK | Black, 23cm dia x 3cm | 12 ea |



...BUT NEVER
DUPLICATED.

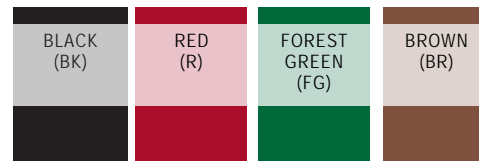



BRINGING IT ALL TO THE TABLE

Form follows function very closely when it comes to our serving tools for your dining room. Our tray stands and high chairs are made to last in colors and styles to match any decor. Our accessories will also enhance your guest's experience.



DINING ROOM TOOLS | 111

| | |
|-------------------------------------|-----|
| Wooden Tray Stands | 111 |
| Wooden Folding Crate Stands | 111 |
| Metal Tray Stands..... | 112 |
| Check Spindle | 112 |
| Call Bell | 112 |
| Table Crumber With Pocket Clip..... | 112 |
| High Chairs..... | 113 |





b



d

STANDS
THER
LIV
ER

DINING ROOM WOODEN TRAYS STANDS

TRAY STANDS

- Rubber slip-proof top rings
- Tall tray stand reduces back strain and fatigue

| Item # | Description | Min Order/ Case Pack |
|--|--------------------|-------------------------|
| TRAY STANDS – WOOD MAHOGANY FINISH | | |
| 22 | 96.5 x 45.5 x 43cm | 1 ea |
| a. 21 | 81.5 x 42 x 42cm | 1 ea |
| TRAY STANDS – BLACK PAINTED WOOD FINISH | | |
| b. 10399 | 81.5 x 42 x 42cm | 1 ea |

Rubber non-slip rings to keep straps & tray in place



a

Now available
in black



b

FOLDING CRATE STANDS

Perfect for room service, breakfast in bed or as a riser on your serving presentation. Our new folding crate stands work with our 1/1 GN Crates (sold separately)

- Available in both Acacia and Black Painted Rubberwood
- 67.5 x 34 x 22cm (open)
- and 54.5 x 34 x 3cm (closed)
- Weight limit: 12kg

| Item | Description | Min Order/ Case Pack |
|--|--|-------------------------|
| FOLDING CRATE STANDS FOR 1/1 GN CRATES-WOOD | | |
| c. 10765 | Folding Crate Stand, Acacia, 67.5 x 34 x 22 cm | 1 ea / 4 ea |
| d. 10766 | Folding Crate Stand, Black Painted Rubberwood, 67.5 x 34 x 22 cm | 1 ea / 4 ea |



c



Folds flat for
easy storage



d

HELPFUL HINT:

We do not recommend using folding crate stands to transport heavy items for display; position stand, add crate, and fill.



DINING ROOM METAL TRAY STANDS

Double Bar for added stability



Heavy tubular construction

TRAY STANDS

- Rubber slip-proof top rings
- Tall tray stand reduces back strain and fatigue

| Item # | Description | Min Order/Case Pack |
|---|---|---------------------|
| TRAY STANDS – CHROME PLATED OR BLACK POWDER COATED METAL | | |
| 23 | Single Bar, Chrome Plated, 75.5 x 44 x 44cm | 1 ea |
| a. 24 | Double Bar, Chrome Plated, 80.5 x 46.5 x 42cm | 1 ea |
| b. 23BK | Single Bar, Black, 75.5 x 44 x 44cm | 1 ea |
| 24BK | Double Bar, Black, 80.5 x 46.5 x 42cm | 1 ea |

ACCESSORIES ASSORTED



| Item # | Description | Min Order/Case Pack |
|--------------------------------|--|---------------------|
| DINING ROOM ACCESSORIES | | |
| c. 172 | Check Spindle, Brass Plated, 9cm dia with 15cm spike | 1 ea / 12 ea |
| d. 8381 | Call Bell, Chrome Plated, 8.5cm dia x 6cm | 1 ea / 12 ea |
| e. 518 | Table Crumbler, Gold Anodised Aluminium, 15cm | 12 ea / 120 ea |
| f. 519 | Table Crumbler, Stainless Steel, 15cm | 12 ea / 48 ea |

HIGH CHAIRS

Keep your child seated safely with TableCraft's EU Compliant High Chairs. This simple, yet contemporary design is available in four colours to match any setting: black, white, natural & walnut finish. Durable, hardwood construction with washable replacement straps allows for easy cleaning with a damp cloth.

Our High Chairs comply with BS EN 14988:2017 Pt 1&2+A1:2020.

- Space saving, stackable design for easy storage
- Easy to clean with damp cloth, no food traps
- Adjustable 3-point waist strap harness
- Available in white, natural, walnut and black finishes
- Pre-assembled or flat packed

NEW

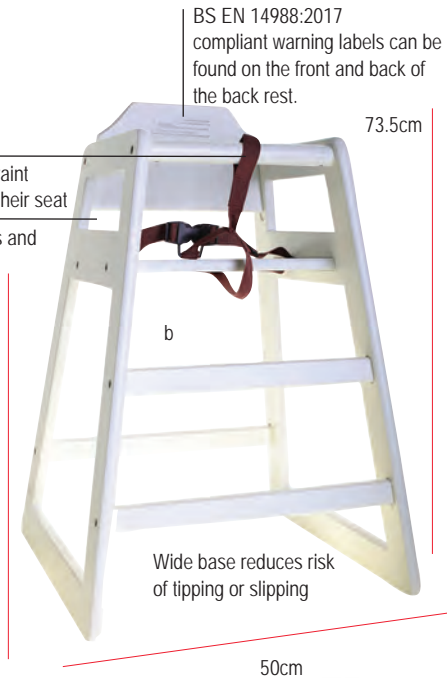

| Item # | Description | Min Order/ Case Pack |
|--|--|----------------------|
| BLACK | | |
| 61EU ▶ | Unassembled, 50 x 50 x 73.5cm | 1 ea |
| a. 61EUA ▶ | Assembled, 50 x 50 x 73.5cm | 1 ea |
| WHITE | | |
| 63EU | Unassembled, 50 x 50 x 73.5cm | 1 ea |
| b. 63EUA | Assembled, 50 x 50 x 73.5cm | 1 ea |
| NATURAL | | |
| 65EU | Unassembled, 50 x 50 x 73.5cm | 1 ea |
| c. 65EUA | Assembled, 50 x 50 x 73.5cm | 1 ea |
| WALNUT | | |
| 66EU | Unassembled, 50 x 50 x 73.5cm | 1 ea |
| d. 66EUA | Assembled, 50 x 50 x 73.5cm | 1 ea |
| REPLACEMENT PARTS & ACCESSORIES | | |
| 60EU | Black Replacement Strap, 35.5 x 3 x 2.5cm for 61EU | 1 ea / 240 ea |
| 67EU | Brown Replacement Strap, 35.5 x 3 x 2.5cm for 63EU, 65EU, 66EU | 1 ea / 240 ea |
| *Due to volumetric freight restrictions, please call customer service to discuss freight options. 01536 400091 | | |



A hand is shown squeezing a white plastic bottle with a blue ring at the bottom, dispensing a white liquid dressing onto a salad in a white bowl. The salad consists of green lettuce, orange carrots, and golden-brown croutons. The background is a kitchen counter with various colorful bottles and a blurred salad bowl.

SQUEEZE AS YOU PLEASE!

A long-standing favourite of diners, sandwich shops and professional chefs around the world, our squeeze bottles are known for their superior quality. TableCraft offers a wide range of squeeze bottles with tops that can be modified to meet your operational needs.

SQUEEZE BOTTLE SIZE GUIDE | 116

Squeeze Bottle Guides & Accessories 116

INVERTATOP™ SQUEEZE BOTTLES | 150

Invertatop™ 53mm Squeeze Bottles 118

Invertatop™ 53mm Coloured End Caps 118

Invertatop™ 63MM Squeeze Bottles 118

Invertatop™ 63MM Coloured End Caps 118

WIDEMOUTH™ SQUEEZE BOTTLES | 152

Widemouth™ 53mm Squeeze Bottle 120

Widemouth™ 63mm Squeeze Bottle 120

DualWay™ Widemouth™

63MM Squeeze Bottle 121

DualWay™ Three Tiptop™ Selectop™

Widemouth™ 63MM Squeeze Bottles 121

Three Tiptop™ Selectop™ Widemouth™

63mm Squeeze Bottle 122

SaferFood Solutions™ Widemouth™

63MM Squeeze Bottle 122

SaferFood Solutions™ BBQ Brush 122

STANDARD SQUEEZE BOTTLES & ACCESSORIES | 123

Nostalgia Squeeze Bottles 123

Chef's Squeeze Bottles 123

Flip Top Cap Squeeze Bottles 123

Standard Squeeze Bottles 124

Squeeze Bottles Accessories 124

Forge Collection™ Squeeze Bottle Caddies 125

Squeeze Bottle Holders 125



View a video on all of the features and benefits of our 11253K-12 Squeeze Bottle



SQUEEZE BOTTLE SOLUTIONS



Our squeeze bottles can be imprinted with your business or restaurant's one color logo. Contact your TableCraft Sales Representative for details.



Scan code or go to our YouTube channel to watch our squeeze bottles video



53MM INVERTATOP™ VALVETOP™ SQUEEZE BOTTLES

NSF



12SV
12oz / 355ml bottle
standard stock



16SV
16oz / 475ml bottle
with SB53Y (band)

THE BLING IS THE THING

From prep to presentation, back of the house to the tabletop, TableCraft has the squeeze bottles and accessories to serve your customers quickly and easily, promote food safety and provide operators efficiency.

Colour End Caps and matching Silicone Bands are effective ways to identify Invertatop™ Bottle contents whether bottles are stored right side up or upside down.

63MM INVERTATOP™ VALVETOP™ SQUEEZE BOTTLES

NSF



24SV
24oz / 710 ml bottle
with 63FCAPLBL (cap)



32SV
32oz / 950ml bottle
with SB63LGN (band)
and 63FCAPLGN (cap)

Replacement Parts



53TSVN (Fits 53mm)
Valve & Top Assembly



53FCAP (Fits 53mm) End Cap



63FCAP (Fits 63mm) End Cap

Specialty Top



10162BK Basting Brush
(Fits 24SV Squeeze Bottles)

Replacement Tops



53TC (Fits 53mm)
Standard Cone Top



63TC (Fits 63mm)
Standard Cone Top



363TC (Fits 63mm)
Wide Cone Top

Coloured End Caps



Yellow = Y
53FCAPY (Fits 53mm)
63FCAPY (Fits 63mm)



Blue = BL
53FCAPBL (Fits 53mm)
63FCAPBL (Fits 63mm)



Red = R
53FCAPR (Fits 53mm)
63FCAPR (Fits 63mm)



Black = BK
53FCAPBK (Fits 53mm)
63FCAPBK (Fits 63mm)



Light Blue = LBL
53FCAPLBL (Fits 53mm)
63FCAPLBL (Fits 63mm)



Lime Green = LGN
53FCAPLGN (Fits 53mm)
63FCAPLGN (Fits 63mm)

Assorted Pack of 12
(2 each of colours shown to left)
53FCAPA (Fits 53mm)
63FCAPA (Fits 63mm)

Pack of single colour:
(12 each of one colour shown to left - add colour identification)
53FCAP_(Fits 53mm)
63FCAP_(Fits 63mm)

53MM WIDEMOUTH™ SQUEEZE BOTTLES



10853C – Standard Cone Tip
8oz / 240ml bottle
with SB53BK (band)



11253C – Standard Cone Tip
12oz / 355ml



11663C – Standard Cone Tip
16oz / 475ml bottle
31763C – WideMouth™ Cone
Tip with C100TA (red tip)



12463C – Standard Cone Tip
24oz / 710ml bottle
32563C – WideMouth™ Cone Tip
with SB63BL (band)



3263C – Standard Cone Tip
32oz / 950ml
63TC – WideMouth™ Cone Tip

Standard Cone
Tips–2.8mm Opening
Wide Cone Tips–4.2mm
Opening

Tethered Caps & Silicone Bands



C100TC – Standard Cone Tip, Natural
(Fits 53mm & 63mm)



C100TA – Standard Cone Tip,
Assorted Colours
(Fits 53mm & 63mm)



CASH & CARRY
PACKS available in
assorted colours only
(2 each of colour)
SB53A (Fits 53mm)
SB63A (Fits 63mm)



INVERTATOP™ SQUEEZE BOTTLES









b

Can be used as a storage cap for all 53mm bottles



END CAP COLOURS

| | | | | | |
|--|---|---|---|---|---|
|  |  |  |  |  |  |
| YELLOW (Y) | BLUE (BL) | RED (R) | BLACK (BK) | LT. BLUE (LBL) | LT. GREEN (LGN) |

TO ORDER END CAPS:

53FCAP Y

ITEM NUMBER Colour

*Leave blank for Natural

INVERTATOP™ 53MM SQUEEZE BOTTLES

- Easy-clean ValveTop™ works with fast-flow and slow-flow liquids, sauces and condiments; also allows for small particles (up to 3mm)
- Fill your bottle from the top and dispense from the bottom; ideal for busy food areas and minimises waste
- Coloured end caps provide easy identification (sold separately)



| Item # | Description | Capacity | Min Order/ Case Pack |
|--|--|----------|----------------------|
| LDPE BOTTLE, 53MM HDPE CAP | | | |
| 12SV | 12oz Universal ValveTop™ | 355 ml | 12 ea |
| a. 16SV | 16oz Universal ValveTop™ | 475 ml | 12 ea |
| *C12SV | 12oz Universal ValveTop™ (6 per pack) | 355 ml | 8 pk |
| *C16SV | 16oz Universal ValveTop™ (6 per pack) | 475 ml | 8 pk |
| REPLACEMENT PARTS & ACCESSORIES | | | |
| 53TSVN | Valve & Top Assembly For NSF® InvertaTop™ Fits 53mm Bottles, Natural | — | 12 ea |
| 53FCAP | 53mm End Cap, Natural | — | 12 ea |

*Available as Cash & Carry

INVERTATOP™ 53MM COLOURED END CAPS

- Coloured end caps provide easy identification



| Item # | Description | Min Order/ Case Pack |
|--|--|----------------------|
| HDPE CAP, 53MM | | |
| b. *53FCAPA | 53mm, Assorted, Pack of 12 (Includes 2 of each colour) | 1 pk |
| REPLACEMENT PARTS & ACCESSORIES | | |
| 53FCAP_ | 53mm End Cap, Colour, Pack of 12 | 1 pk |

INVERTATOP™ 63MM SQUEEZE BOTTLES

- Easy-clean ValveTop™ works with fast-flow and slow-flow liquids, sauces and condiments; also allows for small particles (up to 3mm)
- Fill your bottle from the top and dispense from the bottom; ideal for busy food areas and minimises waste
- Coloured end caps provide easy identification (sold separately)



| Item # | Description | Capacity | Min Order/ Case Pack | |
|--|-------------|--|-------------------------|-------|
| LDPE BOTTLE, 63MM HDPE CAP | | | | |
| | 24SV | 24oz Universal ValveTop™ | 710 ml | 12 ea |
| a. | *C24SV | 24oz Universal ValveTop™ (6 per pack) | 710 ml | 8 pk |
| b. | 32SV | 32oz Universal ValveTop™ | 950 ml | 12 ea |
| REPLACEMENT PARTS & ACCESSORIES | | | | |
| | 63FCAP | 63mm End Cap, Natural | — | 12 ea |

INVERTATOP™ 63MM COLOURED END CAPS

- Coloured end caps provide easy identification



| Item # | Description | Min Order/ Case Pack | |
|--|-------------|---|------|
| HDPE CAP, 63MM | | | |
| c. | *63FCAPA | 63mm, Assorted (Includes 2 of each colour) Pack of 12 | 1 pk |
| REPLACEMENT PARTS & ACCESSORIES | | | |
| | 63FCAP_ | 63mm End Cap, Colour, Pack of 12 | 1 pk |



Great for high viscosity, slow flowing condiments such as barbeque, mayonnaise and tartar!

Can be used as a storage cap for all 63mm bottles

TO ORDER THIS END CAP
63FCAP BL
ITEM NUMBER Colour
*Leave blank for Natural



WIDEMOUTH™ 53MM AND 63MM SQUEEZE BOTTLES

- Large opening for easy filling and cleaning
- Ideal option for fast preparation and service areas
- Available with either standard or wide cone tops



CUSTOM IMPRINTING available,
Contact your TableCraft sales rep
for a further details.



* CASH & CARRY
packaging

| Item # | Description | Capacity | Min Order/ Case Pack |
|--|--|----------|-------------------------|
| LDPE BOTTLE, 53MM POLYETHYLENE TOP | | | |
| 10853K-12 | 8oz Ketchup, Red Top | 240 ml | 12 ea |
| 10853M-12 | 8oz Mustard, Yellow Top | 240 ml | 12 ea |
| 10853C-12 | 8oz Clear, Natural Top | 240 ml | 12 ea |
| C10853K* | 8oz Ketchup, Red Top, Pack of 6 | 240 ml | 12 pk |
| C10853M* | 8oz Mustard, Yellow Top, Pack of 6 | 240 ml | 12 pk |
| C10853C* | 8oz Clear, Natural Top, Pack of 6 | 240 ml | 12 pk |
| 11253K-12 | 12oz Ketchup, Red Top | 355 ml | 12 ea |
| 11253M-12 | 12oz Mustard, Yellow Top | 355 ml | 12 ea |
| 11253C-12 | 12oz Clear, Natural Top | 355 ml | 12 ea |
| C11253K* | 12oz Ketchup, Red Top, Pack of 6 | 355 ml | 12 pk |
| C11253M* | 12oz Mustard, Yellow Top, Pack of 6 | 355 ml | 12 pk |
| C11253C* | 12oz Clear, Natural Top, Pack of 6 | 355 ml | 12 pk |
| REPLACEMENT PARTS & ACCESSORIES | | | |
| a. | 53TBL 53mm Standard Cone Tip, Blue | — | 12 ea |
| | 53TC 53mm Standard Cone Tip, Natural | — | 12 ea |
| | 53TK 53mm Standard Cone Tip, Red | — | 12 ea |
| | 53TM 53mm Standard Cone Tip, Yellow | — | 12 ea |
| LDPE BOTTLE, 63MM POLYETHYLENE TOP | | | |
| b. | 11663K-12 16oz Ketchup, Red Top | 475 ml | 12 ea |
| c. | 11663M-12 16oz Mustard, Yellow Top | 475 ml | 12 ea |
| d. | 11663C-12 16oz Clear, Natural Top | 475 ml | 12 ea |
| | C11663C* 16oz Clear, Natural Top, Pack of 6 | 475 ml | 8 pk |
| | 12463K-12 24oz Ketchup, Red Top | 710 ml | 12 ea |
| | 12463M-12 24oz Mustard, Yellow Top | 710 ml | 12 ea |
| | 12463C-12 24oz Clear, Natural Top | 710 ml | 12 ea |
| | C12463K* 24oz Ketchup, Red Top, Pack of 6 | 710 ml | 12 pk |
| | C12463M* 24oz Mustard, Yellow Top, Pack of 6 | 710 ml | 8 pk |
| | C12463C* 24oz Clear, Natural Top, Pack of 6 | 710 ml | 8 pk |
| e. | 3263C 32oz Clear, Natural Top | 950 ml | 12 ea |
| | C3263C* 32oz Clear Natural Top, Pack of 6 | 950 ml | 6 pk |
| REPLACEMENT PARTS & ACCESSORIES | | | |
| | 63TC 63mm WideMouth™ Cone Tip, Natural | — | 12 ea |
| | 63TK 63mm WideMouth™ Cone Tip, Red | — | 12 ea |
| | 63TM 63mm WideMouth™ Cone Tip, Yellow | — | 12 ea |

| Item # | Description | Capacity | Min Order/ Case Pack |
|--|---|----------|-------------------------|
| LDPE BOTTLE, 63MM POLYPROPYLENE TOP | | | |
| a. 31763C | 16oz Clear, Natural Top | 475 ml | 24 ea |
| 32563C | 24oz Clear, Natural Top | 710 ml | 12 ea |
| REPLACEMENT PARTS & ACCESSORIES | | | |
| 363TC | 63mm Wide Tip Cone, Natural | — | 12 ea |
| LDPE BOTTLE, 63MM HDPE CAP | | | |
| 11663CF | 16oz Clear, Cone Tip, Natural Top | 475 ml | 12 ea |
| b. 12463CF | 24oz Clear, Cone Tip, Natural Top | 710 ml | 12 ea |
| REPLACEMENT PARTS & ACCESSORIES | | | |
| 63TC | 63mm, Cone Tip, Natural | — | 12 ea |
| 63FCAP_ | 63mm End Cap, Colour, Pack of 12 | — | 1 pk |
| LDPE BOTTLE, 63MM HDPE CAP | | | |
| c. 11663C3F | 16oz Clear, Natural Three Tiptop™ SelecTop™ | 475 ml | 12 ea |
| 12463C3F | 24oz Clear, Natural Three Tiptop™ SelecTop™ | 710 ml | 12 ea |
| REPLACEMENT PARTS & ACCESSORIES | | | |
| 63TC3 | 63mm, Three Tiptop™ SelecTop™, Natural | — | 12 ea |
| 63FCAP | 63mm End Cap, Natural | — | 12 ea |

DUALWAY™ THREE TIPTOP™ SELECTOP™ WIDEMOUTH™ 63MM SQUEEZE BOTTLES



c



WIDEMOUTH™ 63MM SQUEEZE BOTTLE

- Wide cone tip



SQUEEZE BOTTLE SOLUTIONS
WIDEMOUTH™ DUALWAY™ & SELECTOP™



DUALWAY™ WIDEMOUTH™ 63MM SQUEEZE BOTTLES

- Innovative bottle uses leakproof PerfectFlex™ for rapid food preparation
- Fill your bottle from the bottom and dispense from the top



SAFERFOOD SOLUTIONS™ BOTTLES



SAFERFOOD SOLUTIONS™ WIDEMOUTH™

63MM SQUEEZE BOTTLE

- Easy-clean solution, suitable for all sauces
- Allows for increased efficiency and food preparation management

| Item # | Description | Capacity | Min Order/ Case Pack |
|----------------------------|-------------|-------------------------|-------------------------|
| LDPE BOTTLE, 63MM HDPE CAP | | | |
| a. | N20C | 20oz Clear, Natural Top | 590 ml 12 ea |

SAFERFOOD SOLUTIONS™ BBQ BRUSH & DISPENSING SYSTEM

- For dispensing and brushing dressings
- Brush is made from heat-safe silicone

| Item # | Description | Min Order/ Case Pack |
|---|--|-------------------------|
| LDPE BOTTLE, HDPE CAP WITH SILICONE BRUSH | | |
| b. | 10162BK BBQ Brush Only, Black (fits 24SV Squeeze Bottle) | 12 ea |
| c. | 10727 BBQ Brush and 24oz / 710ml Invertatop™ Squeeze Bottle (24SV) Set | 12 ea |

THREE TIPTOP™ SELECTOP™ WIDEMOUTH™

63MM SQUEEZE BOTTLE

- Three tips for even dispensing

| Item # | Description | Capacity | Min Order/ Case Pack |
|-------------------------------------|---|-------------------------|-------------------------|
| LDPE BOTTLE, 63MM POLYPROPYLENE TOP | | | |
| d. | 11663C3 | 16oz Clear, Natural Top | 475 ml 12 ea |
| e. | 12463C3 | 24oz Clear, Natural Top | 710 ml 12 ea |
| f. | 3263C3 | 32oz Clear, Natural Top | 950 ml 12 ea |
| REPLACEMENT PARTS & ACCESSORIES | | | |
| 63TC3 | 63mm, Three Tiptop™ SelecTop™, Natural | — | 12 ea |

ADD SOME SPECIAL SAUCE

| Item # | Description | Capacity | Min Order/ Case Pack |
|---|---|----------------|-------------------------|
| NOSTALGIA SQUEEZE BOTTLES – LDPE BOTTLE, 38MM POLYPROPYLENE TOP | | | |
| 1112C | 12oz Clear, Cone Tip, Natural Top | 355 ml | 12 ea |
| 1112K | 12oz Red, Cone Tip, Red Top | 355 ml | 12 ea |
| 1112M | 12oz Yellow, Cone Tip, Yellow Top | 355 ml | 12 ea |
| a. *1112KMC | 3 pc Set, (1) 1112K, (1) 1112M, (1) 1112C | (3) 355 ml | 12 ea |
| CHEF'S SQUEEZE BOTTLES – LDPE BOTTLE, HDPE CAP | | | |
| 1102 | 2oz Clear, Natural Top | 60 ml | 24 ea |
| 1104 | 4oz Clear, Natural Top | 120 ml | 24 ea |
| b. *H110204 | Bottle Set, Clear, Carded (1) 1102 & (1) 1104, 2 & 4 oz | 60 ml & 120 ml | 6 ea |
| FLIP TOP CAP SQUEEZE BOTTLES – LDPE BOTTLE, 38MM POLYPROPYLENE TOP | | | |
| c. 2132C | 32oz Clear with White Hinged Cap | 950 ml | 12 ea |

NOSTALGIA SQUEEZE BOTTLES

- Adds retro flair with the classic 1950s graphic design
- Great for front-of-house service



a



b



CHEF'S SQUEEZE BOTTLES



FLIP TOP CAP SQUEEZE BOTTLES

- Flip-top cap offers a cleaner and fresher service solution
- Perfect for catering and take away service



c



A PLACE FOR EVERYTHING...



a



b



c



d



e



11663C-12 Standard Cone Tip
16oz / 475ml bottle
31763C - Widemouth™ Cone Tip
with C100TA (red tip)



f



g



h

STANDARD SQUEEZE BOTTLES



| Item # | Description | Capacity | Min Order/ Case Pack |
|---|---|----------|-------------------------|
| STANDARD SQUEEZE BOTTLES – CLEAR LDPE BOTTLE, 38MM POLYPROPYLENE TOP | | | |
| a. | 32C 32oz Wide Cone Tip, Natural Top | 950 ml | 12 ea |
| REPLACEMENT PARTS & ACCESSORIES | | | |
| b. | 100TC 38mm Standard Cone Tiptop™, Natural | — | 12 ea |
| c. | 100TK 38mm Standard Cone Tiptop™, Red | — | 12 ea |
| d. | 100TM 38mm Standard Cone Tiptop™, Yellow | — | 12 ea |

ACCESSORIES

*



| Item # | Description | Min Order/ Case Pack |
|--------------------|---|-------------------------|
| ACCESSORIES | | |
| e. | *SB53A Assorted Silicone Sauce Bands for 53mm bottles (Includes 2 of each colour) Pack of 12 | 1 pk / 12 pk |
| | *SB63A Assorted Silicone Sauce Bands for 63mm bottles (Includes 2 of each colour) Pack of 12 | 1 pk / 12 pk |
| f. | C100TC Squeeze Bottle Tethered Cap, Natural (12 per Pack) | 1 pk |
| g. | C100TA Squeeze Bottle Tethered Cap, Assorted Colours (Includes 2 of each Yellow, Blue, Red, Black, Light Blue, Light Green) | 1 pk |
| h. | C100TBK Squeeze Bottle Tethered Cap, Black (12 per Pack) | 1 pk |

AND EVERYTHING IN ITS PLACE

SQUEEZE BOTTLE HOLDERS & GASTRONORM ORGANISERS



| Item # | Description | Min Order/ Case Pack |
|--|--|-------------------------|
| FORGE COLLECTION™ SQUEEZE BOTTLE CADDIES - BLACK GALVANISED STEEL | | |
| a. 11846 ▶ | Holds (4) 63 mm diameter bottles, 18.5 x 18 x 17cm, | 1 ea / 18 ea |
| b. 11847 ▶ | Holds (6) 63 mm diameter bottles, 23 x 18.5 x 17cm | 1 ea / 12 ea |
| SQUEEZE BOTTLE GASTRONORM ORGANISERS - STAINLESS STEEL | | |
| c. SQH6 | Holds up to (6) 63mm diameter bottles, 33.5 x 18 x 11.5cm | 1 ea / 6 ea |
| d. SQH8 | Holds up to (8) 63mm diameter bottles, 33.5 x 18 x 11.5cm | 1 ea / 6 ea |
| e. T4 | Holds up to (4) 53mm diameter bottles (18 x 16cm) fits 1/6 size gastronorm food pan | 1 ea / 12 ea |
| f. T6 | Holds up to (6) (12oz / 355ml, 16oz / 475ml, 24oz / 710ml) 63mm diameter bottles (32.5 x 18cm) fits 1/3 size gastronorm food pan | 1 ea / 12 ea |
| g. T8 | Holds up to (8) (12oz / 355ml or 16oz / 475ml) 53mm diameter bottles (32.5 x 18cm) fits 1/3 size gastronorm food pan | 1 ea / 12 ea |

NEW

See the rest of our Forge Collection™ on page 21

New Forge Collection™ Squeeze Bottle Caddies in black galvanised steel with a mango wood handle bring rustic style to your tabletop



Caddies hold 16 & 24 oz (63 mm) bottles

Rustic style caddies in black galvanised steel

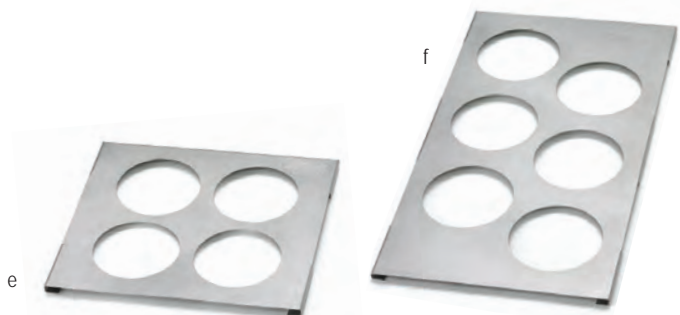
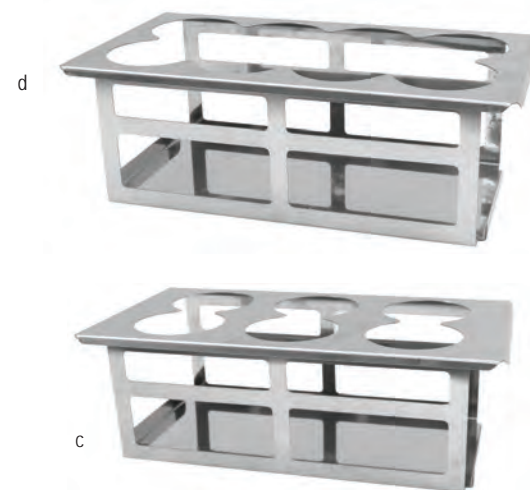

SQUEEZE BOTTLE SOLUTIONS
STANDARD BOTTLES & ACCESSORIES

TOOLS OF THE TRADE

TableCraft's commercial kitchen supplies provide all the elements to keep your kitchen running smoothly and efficiently. From prep to plate, our selection of food prep and kitchen supplies will help minimise waste, offer portion control, save time and adhere to food safety guidelines.



FOOD PREP TOOLS & GADGETS | 128

| | |
|--|-----|
| Perfectgrip™ Utensils..... | 128 |
| Cut-Resistant Gloves..... | 129 |
| Mixing Bowls..... | 131 |
| Footed Colanders..... | 131 |
| High Heat Spoons & Spatulas..... | 131 |
| Low Heat Spoons & Spatulas..... | 131 |
| Wooden Spoons..... | 131 |
| Piano & French Whips..... | 132 |
| Kettle Whip..... | 132 |
| Icing Spatulas..... | 133 |
| Dredges..... | 133 |
| Screen Sifters..... | 133 |
| One-Piece Ladles..... | 134 |
| Utility Tongs..... | 134 |
| Ergonomic Locking Tongs..... | 134 |
| Vinyl Coated Tongs..... | 135 |
| Silicone Tip Tongs..... | 135 |
| Antimicrobial Tongs..... | 135 |
| Basting Spoons..... | 136 |
| Flexible Measuring Cups..... | 137 |
| Premium Measuring Cups..... | 137 |
| Heavyweight Measuring Spoons & Cups..... | 137 |
| Thumb Press Dishers..... | 138 |
| Measuring Ladles..... | 140 |
| Measuring Spoons..... | 140 |
| Pizza Screen..... | 141 |
| One-Piece Spoonouts..... | 142 |
| Silicone & Stainless Steel Utensils..... | 142 |
| High Heat Tools..... | 143 |
| Food Turners & Utensils..... | 144 |

CUTTING BOARDS & ACCESSORIES | 145

| | |
|-----------------------------------|-----|
| Grippy Cutting Boards..... | 145 |
| Cutting Boards..... | 145 |
| Flexible Cutting Boards..... | 145 |
| Cutting Board Racks..... | 146 |
| PerfectGrip® Knife Sharpener..... | 146 |
| Knife Rack..... | 146 |
| Magnetic Knife Holders..... | 146 |
| Skewers..... | 147 |

| | |
|----------------------------|-----|
| Graters..... | 147 |
| Crinkle Cut Mezzaluna..... | 147 |

KITCHEN SUPPLIES & EQUIPMENT | 148

| | |
|---------------------------------------|-----|
| Burrito/Taco Fry Baskets..... | 148 |
| Taco Bowl Fry Baskets..... | 148 |
| Prep Trays, Rails..... | 148 |
| Taco Tostada Fry Baskets..... | 148 |
| Fryer Baskets..... | 149 |
| Pasta Baskets..... | 149 |
| French Fry Scoops..... | 149 |
| Prep Tray Rails..... | 149 |
| Potato Mashers..... | 150 |
| Kettle Whips..... | 150 |
| Skimmers..... | 150 |
| Double Mesh Strainers..... | 150 |
| Single Mesh Strainers..... | 150 |
| Strainers..... | 150 |
| 4 Egg Ring..... | 151 |
| Meat Tenderisers..... | 151 |
| Steak Weights..... | 151 |
| Kenkut® 3 Film or Foil Dispenser..... | 153 |
| Griddle Stones..... | 154 |
| Heavy Duty Grill Scraper..... | 154 |
| Order Holder..... | 155 |
| Funnels..... | 155 |

FLATWARE HOLDERS | 156

| | |
|--|-----|
| Flatware Cylinders & Tiered Holders..... | 156 |
| Cutlery Bins..... | 156 |

CONDIMENT DISPENSERS & PUMPS | 157

| | |
|------------------------------|-----|
| NSF® Option™ Dispensers..... | 157 |
| LDPE Bottles..... | 157 |
| HDPE Jugs..... | 157 |
| Storage Caps..... | 157 |

NEW



Improved Hang Hole

Packaged for Cash & Carry.

PERFECTGRIP™ UTENSILS

• Patented ergonomic soft grip, non-slip handles for comfort and safety



Peelers have built-in potato eyer

| Item | Description | Min Order / Case Pack |
|------------------------------|--|-----------------------|
| PERFECTGRIP™ UTENSILS | | |
| a. | 10973 ▶ Paring Knife | 1 ea / 12 ea |
| b. | 10974 ▶ Double Pastry Cutter | 1 ea / 12 ea |
| c. | 10975 ▶ Oyster Shucker | 1 ea / 12 ea |
| d. | 10976 ▶ Small Slotted Spatula | 1 ea / 12 ea |
| e. | 10977 ▶ "Y" Peeler, Julienne Edge | 1 ea / 12 ea |
| f. | 10978 ▶ Grater, Small Holes | 1 ea / 12 ea |
| g. | 10979 ▶ Grater/Zester | 1 ea / 12 ea |
| h. | 10980 ▶ Straight Peeler, Serrated Edge | 1 ea / 12 ea |
| i. | 10981 ▶ Cheese Plane | 1 ea / 12 ea |
| j. | 10982 ▶ Melon Baller | 1 ea / 12 ea |
| k. | 10983 ▶ Grater, Medium Holes | 1 ea / 12 ea |
| l. | 10984 ▶ Grater, Large Holes | 1 ea / 12 ea |
| m. | 10985 ▶ Apple Corer | 1 ea / 12 ea |
| n. | 10986 ▶ Ice Cream Disher** | 1 ea / 12 ea |
| o. | 10987 ▶ Y Peeler, Serrated Edge | 1 ea / 12 ea |
| p. | 10989 ▶ Garlic Press | 1 ea / 12 ea |
| q. | 10990 ▶ Zester/Lemon Peeler | 1 ea / 12 ea |
| r. | 10991 ▶ Tomato Stem Corer | 1 ea / 12 ea |
| s. | 10992 ▶ Pizza Cutter Wheel | 1 ea / 12 ea |
| t. | 10993* ▶ Can Opener** | 1 ea / 12 ea |
| u. | 10994 ▶ Handheld Sharpener | 1 ea / 12 ea |
| v. | 10995 ▶ Kitchen Shears | 1 ea / 12 ea |
| w. | 10996 ▶ "Y" Peeler, Straight Edge | 1 ea / 12 ea |
| x. | 10997 ▶ Straight Peeler, Straight Edge | 1 ea / 12 ea |

*Not NSF listed † Handwash Only



GLOVE SIZING GUIDE

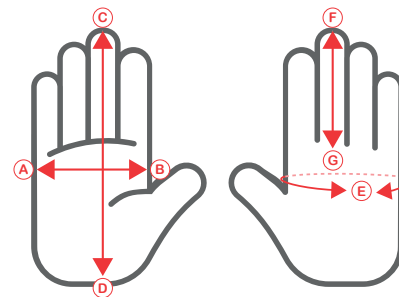

| Item # | Glove Size | Palm Width | | Hand Length | | Palm Circumference | | Finger Length | |
|--------|------------|------------|-------------|-------------|-------------|--------------------|-------------|---------------|-------------|
| | | Inches | Millimeters | Inches | Millimeters | Inches | Millimeters | Inches | Millimeters |
| 11207 | XS | 2½ - 2¾ | 63 - 73 | 6 - 6½ | 152 - 165 | 6 - 7 | 152 - 178 | 3 - 3¼ | 76 - 83 |
| 11208 | S | 2¾ - 3¼ | 73 - 83 | 6½ - 7 | 165 - 178 | 7 - 8 | 178 - 203 | 3¼ - 3½ | 83 - 89 |
| 11209 | M | 3¼ - 3¾ | 83 - 92 | 7 - 7½ | 178 - 191 | 8 - 9 | 203 - 229 | 3½ - 3¾ | 89 - 95 |
| 11210 | L | 3¾ - 4 | 92 - 102 | 7½ - 8 | 191 - 203 | 9 - 10 | 229 - 254 | 3¾ - 4 | 95 - 102 |
| 11211 | XL | 4 - 4¾ | 102 - 112 | 8 - 8½ | 203 - 216 | 10 - 11 | 254 - 280 | 4 - 4¼ | 102 - 108 |

If you are between sizes – size down for a snug fit.

CUT-RESISTANT GLOVES



Protect your back of house team against potential lacerations with our new Cut-Resistant Gloves.

- Seamless weave, ambidextrous design for comfort and safety
- Extended cuff protects the wrist and holds glove in place
- ANSI cut level 6
- Made of HPPE (High Performance Polyethylene), Stainless Steel, spandex, and polyester
- Sold as a pair



| Item # | Description | Min Order/ Case Pack |
|------------------------------------|--|-------------------------|
| CUT-RESISTANT GLOVES (PAIR) | | |
| a. 11207 | X-Small, Black with Red Cuff, Polyethylene | 1 pair / 12 pairs |
| b. 11208 | Small, Black with Yellow Cuff, Polyethylene | 1 pair / 12 pairs |
| c. 11209 | Medium, Black with Green Cuff, Polyethylene | 1 pair / 12 pairs |
| d. 11210 | Large, Black with Blue Cuff, Polyethylene | 1 pair / 12 pairs |
| e. 11211 | X-Large, Black with Black Cuff, Polyethylene | 1 pair / 12 pairs |

MIXING IT UP



| Item # | Description | Capacity | Min Order/ Case Pack |
|--|-------------|---|-------------------------|
| MIXING BOWLS – STAINLESS STEEL, MIRROR FINISH, 0.4MM | | | |
| | 822 | 16.5cm dia x 5cm | 850ml 1 ea / 12 ea |
| a. | 823 | 20cm dia x 6cm | 1.7 L 1 ea / 12 ea |
| b. | 824 | 25.5cm dia x 8cm | 2.1 L 1 ea / 12 ea |
| | 825 | 27cm dia x 9cm | 3.1 L 1 ea / 12 ea |
| | 826 | 30cm dia x 8cm | 3.6 L 1 ea / 24 ea |
| c. | 827 | 33.5cm dia x 10.5cm | 5.3 L 1 ea / 12 ea |
| | 828 | 41cm dia x 12cm | 9.5 L 1 ea / 12 ea |
| | 830 | 48cm dia x 15cm | 17.6 L 1 ea / 12 ea |
| FOOTED COLANDER WITH HANDLES – STAINLESS STEEL, 200 SERIES | | | |
| | 705 | 35.5cm x 30cm x 12cm | — 1 ea / 12 ea |
| | 708 | 40.5cm x 33.5cm x 13cm | — 1 ea / 12 ea |
| FOOTED COLANDER – STAINLESS STEEL, MIRROR FINISH, 0.4MM | | | |
| d. | 713 | 41.5cm dia x 15cm, 49.5cm Width with Handle | 12.3 L 1 ea / 12 ea |
| HIGH HEAT SPOONS/SPATULAS – SILICONE & NYLON | | | |
| e. | 1865 | Spoon Spatula, 26.5cm | — 1 ea / 6 ea |
| | 1866 | Spoon Spatula, 35.5cm | — 1 ea / 6 ea |
| | 1867 | Spoon Spatula, 41.5cm | — 1 ea / 6 ea |
| | 1862 | Spatula, 26.5cm | — 1 ea / 24 ea |
| | 1863 | Spatula, 35.5cm | — 1 ea / 24 ea |
| f. | 1864 | Spatula, 41.5cm | — 1 ea / 24 ea |
| LOW TEMP SPOON / SPATULAS – EVA WITH HIGH IMPACT POLYSTYRENE HANDLE | | | |
| g. | 2510 | Spoon Shaped Spatula, 24cm | — 24 ea |
| | 2514 | Spoon Shaped Spatula, 35.5cm | — 24 ea |
| | 2516 | Spoon Shaped Spatula, 42cm | — 12 ea |
| | 1500 | Flat Blade Spatula, 24cm | — 24 ea |
| | 1510 | Flat Blade Spatula, 25.5cm | — 24 ea |
| | 1514 | Flat Blade Spatula, 35.5cm | — 24 ea |
| h. | 1516 | Flat Blade Spatula, 40.5cm | — 24 ea |
| WOODEN SPOONS – BEECHWOOD | | | |
| | W12 | 30.5cm | — 12 ea |
| i. | W14 | 35.5cm | — 12 ea |
| | W16 | 40.5cm | — 12 ea |
| | W18 | 45.5cm | — 12 ea |

Actual capacity may be slightly less than trade capacity

MIXING BOWLS AND COLANDERS

- Blend, mix, whip and prep ingredients with these durable mixing bowls in Stainless Steel
- Our footed collanders are perfect for rinsing fruits and vegetables, draining pastas, etc.



HIGH HEAT SPOONS / SPATULAS

- Durable flexible design is perfect for prepping and scraping
- Heat resistant to 260°C
- Available in a variety of sizes



BPA FREE



LOW TEMP SPOONS / SPATULAS

- Heat resistant to 60°C



BPA FREE



WOODEN SPOONS



WHIP IT

PIANO & FRENCH WHIPS

A necessity for back of the house food prep. Perfect for mixing and whipping up sauces, toppings, batters and more! Available in a variety of sizes to suit your needs.

- Durable Stainless Steel construction
- Sealed wires for easy cleaning
- Easy to clean, dishwasher safe



KETTLE WHIP



French Whips:
denser wires with a more elongated shape – perfect for mixing emulsions, sauces and batters.



Piano Whips:
thin wires that form a wide rounded balloon shape – great multi-purpose whip for beating egg whites, heavy cream, or other thin liquids.

| Item # | Description | Min Order/ Case Pack |
|--|----------------------------|-------------------------|
| FRENCH WHIPS – STAINLESSS STEEL | | |
| 16 SEALED WIRES, 2MM WIRE GAUGE | | |
| SF10 | 26cm | 1 ea / 12 ea |
| SF12 | 30.5cm | 1 ea / 12 ea |
| a. SF14 | 35.5cm | 1 ea / 12 ea |
| SF16 | 40.5cm | 1 ea / 12 ea |
| SF18 | 45.5cm | 1 ea / 12 ea |
| b. SF20 | 51cm | 1 ea / 12 ea |
| SF24 | 61cm | 1 ea / 12 ea |
| PIANO WHIPS – STAINLESSS STEEL | | |
| 24 SEALED WIRES, 1.2MM WIRE GAUGE | | |
| SP10 | 25.5cm | 1 ea / 12 ea |
| SP12 | 30.5cm | 1 ea / 12 ea |
| c. SP14 | 35cm | 1 ea / 12 ea |
| SP16 | 40.5cm | 1 ea / 12 ea |
| KETTLE WHIPS – STAINLESS STEEL | | |
| d. MW40 | 12.5cm dia, 101.5cm Length | 1 ea / 12 ea |

SHAKE AND SEASON

DREDGES



BPA FREE

| Item # | Description | Capacity | Min Order/ Case Pack |
|---|--|-----------|-------------------------|
| DREDGE – ALUMINIUM | | | |
| a. | H158 Dredge with handle (1.8mm holes) | 295ml | 12 ea |
| DREDGE – STAINLESS STEEL | | | |
| b. | 159 Dredge (1.8mm holes) | 295ml | 1 ea / 12 ea |
| c. | H159 Dredge with handle (1.8mm holes) | 295ml | 1 ea / 12 ea |
| DREDGE – PLASTIC | | | |
| d. | 166A Dredge with Salt & Pepper Lid, Beige | 295ml | 12 ea |
| e. | 166C Dredge with Medium Ground Lid, Rose | 295ml | 12 ea |
| f. | 166D Dredge with Cheese Lid, Yellow | 295ml | 12ea |
| | 166F 3pc Dredge Set. 1 ea with Beige, Rose & Yellow Lids, Polybagged | (3) 295ml | 12 ea |
| TRIPLE SCREEN SIFTER – STAINLESS STEEL | | | |
| g. | H2997BH 5 Cup | 1.1 L | 6 ea |

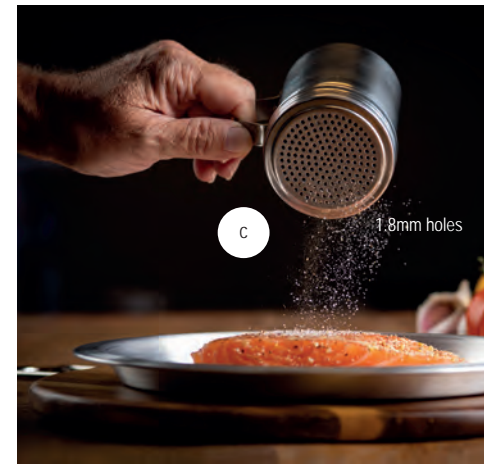

SCREEN SIFTER

Triple screen for finer flour (1.8mm holes)



ICING SPATULAS



| Item # | Description | Min Order/ Case Pack |
|---|-------------------|-------------------------|
| ICING SPATULAS – STAINLESS STEEL W/ WHITE POLYPROPYLENE HANDLE | | |
| h. | 4206 15cm Blade | 1 ea / 12 ea |
| i. | 4208 20.5cm Blade | 1 ea / 12 ea |
| j. | 4210 25.5cm Blade | 1 ea / 12 ea |
| k. | 4212 30.5cm Blade | 1 ea / 12 ea |
| l. | 4214 35.5cm Blade | 1 ea / 12 ea |



ONE-PIECE LADLES



Perfect for portion control, prepping and serving! Available in a variety of sizes to suit your needs. Built in hook for easy hanging and storing.

- Durable Stainless Steel One-Piece Construction
- Capacity markings listed on handle (oz/ml)
- Easy to clean, dishwasher safe



UTILITY TONGS



ERGONOMIC LOCKING TONGS



- Integrated silicone comfort grips

BASTING SPOONS



| Item # | Description | Capacity | Min Order/ Case Pack |
|---|--------------------------------|----------|-------------------------|
| ONE-PIECE LADLE – STAINLESS STEEL, 0.9 MM | | | |
| a. | 4701 1oz 5.5 x 10.5 x 30.5cm | 30ml | 1 ea / 12 ea |
| b. | 4702 2oz 7 x 12 x 32cm | 60ml | 1 ea / 12 ea |
| c. | 4703 3oz 37.5 x 12.5 x 35.5cm | 90ml | 1 ea / 12 ea |
| d. | 4704 4oz 8.5 x 13.5 x 35.5cm | 120ml | 1 ea / 12 ea |
| e. | 4706 6oz 9.5 x 14.5 x 37cm | 180ml | 1 ea / 12 ea |
| f. | 4708 8oz 10.5 x 14.5 x 37.5cm | 240ml | 1 ea / 12 ea |
| g. | 4712 12oz 12.5 x 17.5 x 39.5cm | 355ml | 1 ea / 12 ea |
| UTILITY TONGS – STAINLESS STEEL, WITH SPRING HINGE HEAVYWEIGHT 1.2MM | | | |
| 2774 | 24 x 3.5 x 2cm | | 1 ea / 12 ea |
| 2712 | 30 x 7 x 2.5cm | | 1 ea / 12 ea |
| 2716 | 40.5 x 3 x 2cm | | 1 ea / 12 ea |
| STANDARD 0.7MM | | | |
| h. | 74 24 x 4 x 4cm | | 12 ea |
| i. | 712 30 x 3 x 2cm | | 12 ea |
| j. | 716 40.5 x 1 x 3cm | | 12 ea |
| ERGONOMIC LOCKING TONGS – STAINLESS STEEL, 0.8MM, SILICONE | | | |
| k. | 2009 23 x 4 x 4cm | | 12 ea |
| l. | 2012 34.5 x 4 x 3cm | | 12 ea |
| m. | 2016 3 x 4 x 39cm | | 12 ea |
| STAINLESS STEEL BASTING SPOON, 1.2MM | | | |
| n. | 3711 28 x 6.5 x 2.5cm | 35ml | 12 ea |
| | 3715 38 x 6.5 x 2.5cm | 35ml | 12 ea |

| Item # | Description | Min Order/ Case Pack |
|--|------------------------------------|-------------------------|
| ANTIMICROBIAL ONE-PIECE SERVING TONG, VINYL COATED HANDLE – STAINLESS STEEL | | |
| a. AM3709BL | 23 x 4 x 2.5cm, Blue Handle | 1 ea / 6 ea |
| AM3709G | 23 x 4 x 2.5cm, Green Handle | 1 ea / 6 ea |
| ANTIMICROBIAL V-HINGE SERVING TONG, VINYL COATED HANDLE – STAINLESS STEEL | | |
| AM3716BK | 41.5 x 4 x 4.5cm, Black Handle | 1 ea / 12 ea |
| b. AM3716G | 41.5 x 4 x 4.5cm, Green Handle | 1 ea / 12 ea |
| AM3716Y | 41.5 x 4 x 4.5cm, Yellow Handle | 1 ea / 12 ea |
| COLOUR-CODED VINYL HANDLE, V-HINGE TONGS – STAINLESS STEEL | | |
| c. 3774BKEU | 24.5 x 4 x 3cm, Black Handle | 1 ea / 12 ea |
| d. 3774BLEU | 24.5 x 4 x 3cm, Blue Handle | 1 ea / 12 ea |
| e. 3774GEU | 24.5 x 4 x 3cm, Green Handle | 1 ea / 12 ea |
| f. 3774REU | 24.5 x 4 x 3cm, Red Handle | 1 ea / 12 ea |
| g. 3774YEU | 24.5 x 4 x 3cm, Yellow Handle | 1 ea / 12 ea |
| 3712BKEU | 31.5 x 4 x 3cm, Black Handle | 1 ea / 12 ea |
| 3712BLEU | 31.5 x 4 x 3cm, Blue Handle | 1 ea / 12 ea |
| 3712GEU | 31.5 x 4 x 3cm, Green Handle | 1 ea / 12 ea |
| 3712REU | 31.5 x 4 x 3cm, Red Handle | 1 ea / 12 ea |
| 3712YEU | 31.5 x 4 x 3cm, Yellow Handle | 1 ea / 12 ea |
| 3716BKEU | 41.5 x 3.81 x 4.5cm, Black Handle | 1 ea / 12 ea |
| 3716BLEU | 41.5 x 3.81 x 4.5cm, Blue Handle | 1 ea / 12 ea |
| 3716GEU | 41.5 x 3.81 x 4.5cm, Green Handle | 1 ea / 12 ea |
| 3716REU | 41.5 x 3.81 x 4.5cm, Red Handle | 1 ea / 12 ea |
| 3716YEU | 41.5 x 3.81 x 4.5cm, Yellow Handle | 1 ea / 12 ea |
| SILICONE TIP LOCKING TONGS – STAINLESS STEEL, 0.8MM | | |
| h. 4009BK | 26.5 x 4.5 x 3cm | 12 ea / 12 ea |
| 4012BK | 34.5 x 4.5 x 2.5cm | 12 ea / 12 ea |
| 4016BK | 40.5 x 4 x 2cm | 12 ea / 12 ea |

ANTIMICROBIAL TONGS

- Perfect for serving in the front or back of the house
- Cool-touch, antimicrobial Microban® handle for safe and sanitary use, promotes food safety and reduces the risk of contamination
- Dishwasher safe for temperatures up to 100°C

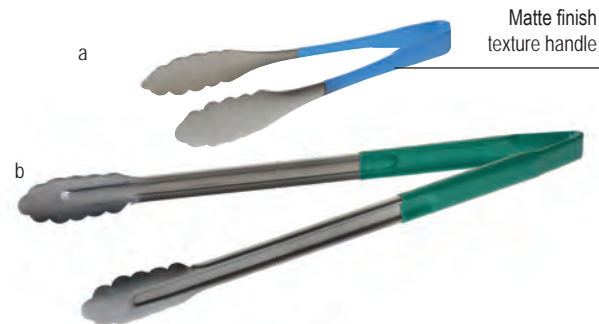

Matte finish texture handle

VINYL-COATED TONGS



- Colour-coded to help prevent cross contamination

SILICONE TIP LOCKING TONGS



- Heat resistance up to 232°C

MEASURING TOOLS

A full range to help you with every measuring need in the kitchen



SILICONE MEASURING CUPS

Lined measurements in cups, ounces and milliliters

3-sided design makes these cups easy to hold while pouring



a

MEASURING CUPS & SPOONS



b

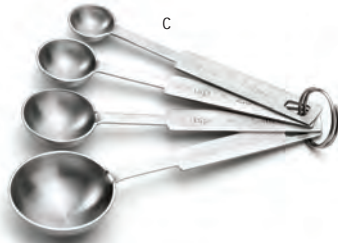

c



d



e



| Item # | Description | Capacity | Min Order/ Case Pack |
|---|--|--------------------------------|-------------------------|
| FLEXIBLE MEASURING CUPS – SILICONE | | | |
| a. | *HSMC3 Set of 3 Includes: 1 Cup, 2 Cup, 4 Cup | 250ml 500ml 1 L | 1 ea / 6 ea |
| PREMIUM MEASURING SETS – ONE-PIECE STAINLESS STEEL | | | |
| b. | 725 4-Pc Set Includes: ¼ Cup, ½ Cup, ½ Cup, 1 Cup | 60ml 80ml 125ml 250ml | 1 ea / 12 ea |
| HEAVYWEIGHT & STANDARD MEASURING SPOONS & CUPS – STAINLESS STEEL | | | |
| c. | 722 Heavyweight, 4-Pc Set Includes: ¼ tsp, ½ tsp, 1 tsp, 1 tbsp | 1ml 2.5ml 5ml 15ml | 1 ea / 12 ea |
| d. | 724 4-pc Cup Set Includes: ¼, ½, ½, 1 Cup | 60ml 80ml 125ml 250ml | 1 ea / 12 ea |
| e. | 40401 1 tbsp Long Handled Spoon, 22cm | 15ml | 1 ea / 12 ea |
| | 40402 2 tbsp Long Handled Spoon, 23cm | 30ml | 1 ea / 12 ea |



Cash & Carry
Packaging

THUMB PRESS DISHERS

- Specially sized scoops, ideal for portion control
- Choose from a range of sizes, colour-coded to indicate capacity



| Item # | Description | Color | Capacity | Min Order |
|--|----------------------------|--------|----------|--------------|
| THUMB PRESS DISHERS – 18/8 STAINLESS STEEL, POLYETHYLENE HANDLE | | | | |
| a. 2108 | Size 8, Grey, 7cm dia | Grey | 118ml | 1 ea / 36 ea |
| b. 2110 | Size 10, Ivory, 6.5cm dia | Ivory | 95ml | 1 ea / 36 ea |
| c. 2116 | Size 16, Blue, 6cm dia | Blue | 70ml | 1 ea / 36 ea |
| d. 2120 | Size 20, Yellow, 5.5cm dia | Yellow | 60ml | 1 ea / 36 ea |
| e. 2124 | Size 24, Red, 5cm dia | Red | 45ml | 1 ea / 36 ea |
| f. 2130 | Size 30, Black, 4.5cm | Black | 35ml | 1 ea / 36 ea |





Stainless Steel
Ramekins and
Sauce Cups
featured on
page 92

Invertatop™
Squeeze Bottle
(C16SV), assorted
colour silicone bands
(SB53A) and cap
(53FCAPLGN)

f

h

b

c

PROMOTING PRO-PORTIONALITY

FOR WHATEVER SPOONFUL YOU REQUIRE...

From spoons to ladles, we have the capacities you need to portion your ingredients and servings.

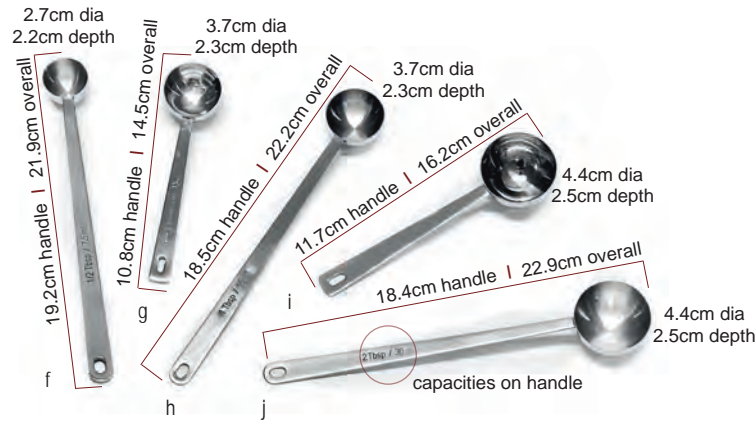
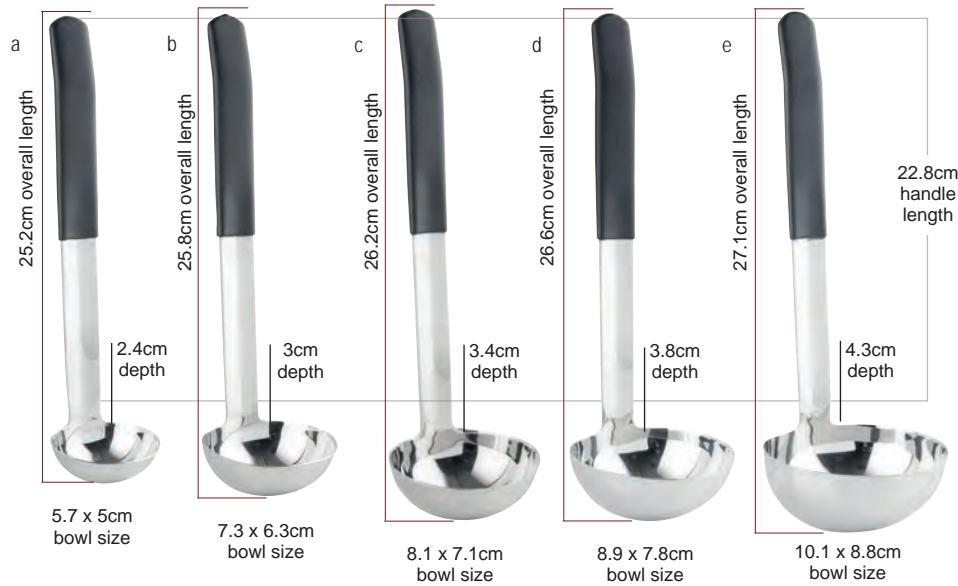

| Item # | Description | Min Order |
|---|--------------------------------------|-------------|
| MEASURING LADLES – STAINLESS STEEL | | |
| a. | AM5301BK 30ml / 1oz Measuring Ladle | 1 ea / 6 ea |
| b. | AM5302BK 60ml / 2oz Measuring Ladle | 1 ea / 6 ea |
| c. | AM5303BK 90ml / 3oz Measuring Ladle | 1 ea / 6 ea |
| d. | AM5304BK 120ml / 4oz Measuring Ladle | 1 ea / 6 ea |
| e. | AM5306BK 180ml / 6oz Measuring Ladle | 1 ea / 6 ea |

| Item # | Description | Min Order |
|---|---|--------------|
| MEASURING SPOONS – STAINLESS STEEL | | |
| f. | 40400 7.5ml / 0.25oz, Long-Handle Spoon | 1 ea / 12 ea |
| g. | 401 15ml / 0.5oz, Short-Handle Spoon | 1 ea / 12 ea |
| h. | 40401 15ml / 0.5oz, Long-Handle Spoon | 1 ea / 12 ea |
| i. | 402 30ml / 1oz, Short-Handle Spoon | 1 ea / 12 ea |
| j. | 40402 30ml / 1oz Long-Handle Spoon | 1 ea / 12 ea |



LADLE IT ON

These Short-Handled Stainless Steel Ladles with Black Vinyl Coating are versatile for portioning ingredients and provide a comfortable grip for the operator, while keeping food and waste cost low.



GET SPICY WITH IT

Our Long and Short Handled Spoons are ideal for adding any dry or liquid seasonings to your recipe from soy sauce or sesame oil, to shredded parmesan or crushed pepper flakes.

SPOON IN...PORTION OUT.

a

ONE-PIECE SPOONOUTS with colour coated handles help to identify capacities for accurate measuring of recipe ingredients



PIZZA SCREEN

- Promotes even cooking and prevents a soggy base
- Oven safe to 232°C

| Item # | Description | Min Order/Case Pack |
|-------------------------------|-------------|---------------------|
| ALUMINIUM PIZZA SCREEN | | |
| PS13 | 33cm dia | 1 ea / 12 ea |

7cm dia
2cm depth

33cm overall length

26cm handle length

a

7.6cm dia
2cm depth

34cm overall length

26.7cm handle length

b

8.3cm dia
2.2cm depth

34cm overall length

26cm handle length

c

9.2cm dia
2.4cm depth

35.6cm overall length

26.4cm handle length

d

9.5cm dia
2.8cm depth

35.6cm overall length

26cm handle length

e

10.5cm dia
2.9cm depth

36.8cm overall length

26.4cm handle length

f

Long-handle Spoonouts are ideal for 110mm to 150mm deep GN pans, especially for liquids (tomato sauce, oil, etc.)

b



ONE-PIECE SPOONOUTS

Cool-to-touch, colour-coded handles indicate capacity ideal for portion control. Available in solid and perforated.

- Stainless Steel and Polypropylene construction
- Capacity markings listed on handle (oz/ml)
- Built in hook for easy hanging and storing
- Safe up to 82°C



| Item # | Description | Colour | Capacity | Min Order/ Case Pack |
|--|---------------------------------|--------|-------------|-------------------------|
| STAINLESS STEEL SOLID SPOONOUT W/ POLYPROPYLENE HANDLE | | | | |
| a. 6702 | 33cm Solid, Red Handle | | 60ml (2oz) | 1 ea / 12 ea |
| b. 6703 | 33cm Solid, Beige Handle | | 90ml (3oz) | 1 ea / 12 ea |
| c. 6704 | 34.5cm Solid, Green Handle | | 120ml (4oz) | 1 ea / 12 ea |
| d. 6705 | 34.5cm Solid, Yellow Handle | | 150ml (5oz) | 1 ea / 12 ea |
| e. 6706 | 35.5cm Solid, Black Handle | | 180ml (6oz) | 1 ea / 12 ea |
| f. 6708 | 35.5cm Solid, Blue Handle | | 240ml (8oz) | 1 ea / 12 ea |
| STAINLESS STEEL PERFORATED SPOONOUT W/ POLYPROPYLENE HANDLE | | | | |
| g. 7704 | 34.5cm Perforated, Green Handle | | 120ml (4oz) | 1 ea / 12 ea |

SILICONE & STAINLESS STEEL UTENSILS

- Stainless Steel core with silicone exterior construction provides a durable, flexible and scratch resistant serving utensil option
- Heat safe up to 204°C
- Easy to clean, dishwasher safe



| Item # | Description | Min Order/ Case Pack |
|---|----------------------------|-------------------------|
| TOOLS – BLACK SILICONE AND STAINLESS STEEL | | |
| h. 39100 | Tongs, 18cm | 1 ea / 6 ea |
| i. 39101 | Tongs, 23cm | 1 ea / 6 ea |
| j. 39102 | Tongs, 30.5cm | 1 ea / 6 ea |
| k. 10050 | 28.5cm Serving Ladle, 30ml | 1 ea / 6 ea |
| l. 10051 | 29.5cm Serving Ladle, 60ml | 1 ea / 6 ea |
| m. 10052 | 31cm Serving Ladle, 120ml | 1 ea / 6 ea |
| n. 10054 | Slotted Spatula, 33cm | 1 ea / 6 ea |
| o. 10055 | Solid Spatula, 33cm | 1 ea / 6 ea |
| p. 10053 | Fish Turner, 35cm | 1 ea / 6 ea |



HIGH HEAT UTENSILS

Upgrade your kitchen tools with these NSF certified high heat tools. Never leave a scratch or mark with these non-abrasive silicone tools.

- Heat resistant up to 204°C
- One-piece construction, odour and stain resistant
- Conveniently packaged for cash & carry



| Item # | Description | Min Order/ Case Pack |
|--|-------------|-------------------------|
| HIGH HEAT TOOLS – SILICONE OVER NYLON, GREY | | |

| | | |
|----|--|-------------|
| a. | 11834 ▶ Wide Spatula Spurtle, 7.5 x 2 x 32cm | 1 ea / 6 ea |
| b. | 11835 ▶ Narrow Spatula Spurtle, 5 x 2 x 33cm | 1 ea / 6 ea |
| c. | 11836 ▶ Wide Slotted Spatula Spurtle, 7.5 x 2 x 26.5cm | 1 ea / 6 ea |
| d. | 11837 ▶ Angled Spatula Spurtle, 5.5 x 2 x 26.5cm | 1 ea / 6 ea |
| e. | 11838 ▶ Slotted Spurtle, 5 x 2 x 26.5cm | 1 ea / 6 ea |
| f. | 11839 ▶ Solid Spurtle, 5 x 1.5 x 22cm | 1 ea / 6 ea |
| g. | 11840 ▶ Narrow Spatula Spurtle, 2.5 x 1.5 x 22cm | 1 ea / 6 ea |
| h. | 11841 ▶ Small Basting Brush, 3.5 x 1.5 x 21cm | 1 ea / 6 ea |
| i. | 11842 ▶ Large Basting Brush, 4.5 x 1.5 x 27.5cm | 1 ea / 6 ea |
| j. | H3900GY 150ml Ladle, 8.5 x 6.5 x 27.5cm | 1 ea / 6 ea |
| k. | H3902GY Spoon, 8.5 x 3 x 29cm | 1 ea / 6 ea |
| l. | H3903GY Perforated Spoon, 10 x 2.5 x 34.5cm | 1 ea / 6 ea |
| m. | H3905GY Slotted Turner, 8 x 3.5 x 30.5cm | 1 ea / 6 ea |
| n. | H3909GY Spatula, 5.5 x 1.5 x 26cm | 1 ea / 6 ea |
| o. | H3910GY Spatula Spoon, 6 x 1.5 x 26cm | 1 ea / 6 ea |



FOOD TURNERS AND UTENSILS



Essential tools for cooking and prepping, on and off the grill! A range of items available with white or black plastic handles or wood riveted handles to suit your needs on the line.

| Item # | Description | Min Order/ Case Pack |
|---|---|-------------------------|
| STAINLESS STEEL & POLYPROPYLENE BLACK ERGONOMIC HANDLE | | |
| a. | 242BKEU Pie Server, 15cm Blade | 1 ea / 12 ea |
| b. | 251BKEU Turner, 12.5cm Blade | 1 ea / 12 ea |
| c. | 253BKEU Scraper, 7.5cm Blade | 1 ea / 12 ea |
| d. | 461BKEU Wide Turner, 11.5 x 16cm Blade | 1 ea / 12 ea |
| e. | 4100BKEU Solid Turner, 18cm Rounded Blade | 1 ea / 12 ea |
| f. | 4104BKEU Sandwich Spreader, 11cm Blade | 1 ea / 12 ea |
| STAINLESS STEEL & WHITE PLASTIC HANDLE | | |
| g. | 242W Pie Server, Plastic Handle, 28cm | 1 ea / 12 ea |
| h. | 251W Turner, 29cm | 1 ea / 12 ea |
| i. | 253W Scraper, Plastic Handle, 24cm | 1 ea / 12 ea |
| j. | 4103W Dough Scraper, 15 x 7.5cm Blade | 1 ea / 12 ea |
| k. | 4106W Pizza Wheel, 10cm dia Blade | 1 ea / 12 ea |
| STAINLESS STEEL & BLACK PLASTIC HANDLE | | |
| l. | AM3331BK Pie Server, Plastic Handle, 24.5cm | 1 ea / 6 ea |
| m. | 10935 Dough Scraper, 15 x 7.5cm Blade | 1 ea / 12 ea |
| n. | 10936 Pizza Wheel, 10cm dia Blade | 1 ea / 12 ea |
| o. | 10942 28cm Fish Turner, 15cm Blade | 1 ea / 12 ea |
| STAINLESS STEEL & WOOD HANDLE | | |
| p. | 242 Pie Server, Plastic Handle, 28cm | 12 ea |
| q. | 254 21.5cm Scraper, 10cm Blade | 12 ea |
| r. | 2003 28cm Fish Turner, 15cm Blade | 1 ea / 12 ea |
| s. | 4100S 37cm Solid Turner, 20cm Rounded Blade | 12 ea |



Ergonomic handle for both left and right-handed users



CUTTING BOARDS



Cutting board rack options on page 138



HACCP chart & stickers included in kits



a

Colour-coded for HACCP guidelines

Heat, chemical and warp resistant

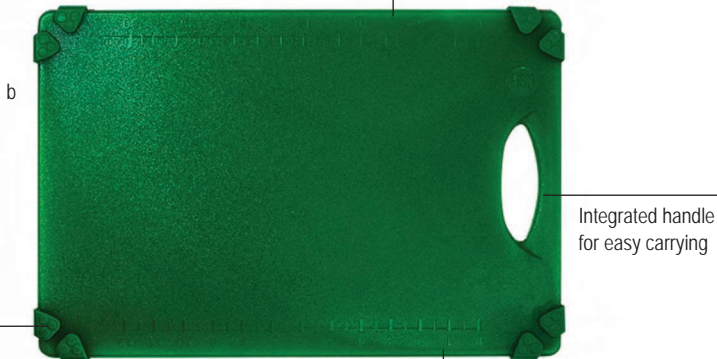

b

Integrated handle for easy carrying

Integrated grips prevent slippage

Integrated measurements help portion foods (cm / inches)

GRIPPY CUTTING BOARDS

- Colour-coded to reduce the risk of cross contamination and promote Hazard Analysis and Critical Control Points (HACCP) guidelines
- Integrated measurements assist with portion control and corner grips help to prevent slippage
- Sanitary and easy to clean with an integrated handle for convenience



| Item # | Description | Min Order/ Case Pack |
|---|---|-------------------------|
| GRIPPY CUTTING BOARDS – POLYPROPYLENE WITH TPE GRIPS | | |
| 45.5 x 30.5 x 1.5cm | | |
| CBG1218AWH | White | 1 ea / 6 ea |
| CBG1218AGN | Green | 1 ea / 6 ea |
| CBG1218ARD | Red | 1 ea / 6 ea |
| CBG1218ABR | Brown | 1 ea / 6 ea |
| CBG1218AYL | Yellow | 1 ea / 6 ea |
| CBG1218ABL | Blue | 1 ea / 6 ea |
| a. CBG1218APR | Purple | 1 ea / 6 ea |
| 51 x 38 x 1.5cm | | |
| CBG1520ABR | Brown | 1 ea / 6 ea |
| b. CBG1520AGN | Green | 1 ea / 6 ea |
| CBG1520APK4 | Pack of 4, Includes: (1 ea of White, Green, Yellow, Red) | 1 ea / 6 ea |
| 61 x 45.5 x 1.5cm | | |
| CBG1824AGN | Green | 1 ea / 6 ea |
| CBG1824ABR | Brown | 1 ea / 6 ea |

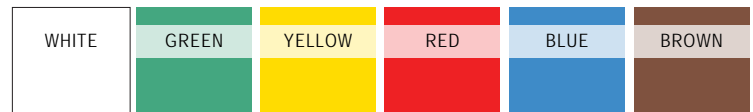

CUTTING BOARDS

- Colour-coded to reduce the risk of cross contamination and promote Hazard Analysis and Critical Control Points (HACCP) guidelines



| Item # | Description | Min Order/ Case Pack |
|--|---|-------------------------|
| CUTTING BOARDS – POLYETHYLENE | | |
| 45.5 x 30.5 x 1.5cm | | |
| CB1218BLA | Blue | 1 ea / 6 ea |
| CB1218BRA | Brown | 1 ea / 6 ea |
| a. CB1218GNA | Green | 1 ea / 6 ea |
| CB1218RA | Red | 1 ea / 6 ea |
| CB1218WA | White | 1 ea / 6 ea |
| CB1218YA | Yellow | 1 ea / 6 ea |
| 61 x 45.5 x 1.5cm | | |
| CB1824BLA | Blue | 1 ea / 6 ea |
| CB1824BRA | Brown | 1 ea / 6 ea |
| CB1824GNA | Green | 1 ea / 6 ea |
| CB1824RA | Red | 1 ea / 6 ea |
| CB1824WA | White | 1 ea / 6 ea |
| CB1824YA | Yellow | 1 ea / 6 ea |
| FLEXIBLE CUTTING BOARDS – POLYPROPYLENE | | |
| 45.5 x 30.5cm (1.4mm THICKNESS) | | |
| b. FCB1218A | Assorted Pack Includes: Blue, Yellow, Green, White, Brown & Red | 1 ea / 6 ea |



a



Risk of cross contamination is reduced with colour-coding



b

FLEXIBLE CUTTING BOARDS

- Assorted packs include (1) each of blue, green, brown, red, white and yellow



Flexible Cutting Boards are lightweight, useful for outside catering events

CUTLERY TOOLS

CUTTING BOARD RACKS

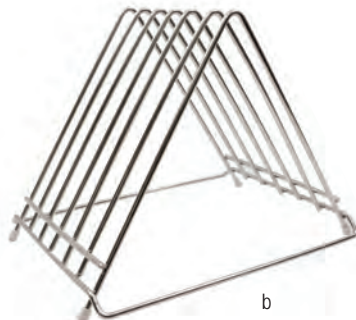

*Brushes and boards not included

KNIFE RACK

- Rack designed to hold 12 knives, 1 cleaver, and 1 sharpener
- 37.5 cm slot depth
- Can be mounted to wall or counter
- Perfect for keeping counter tops clear

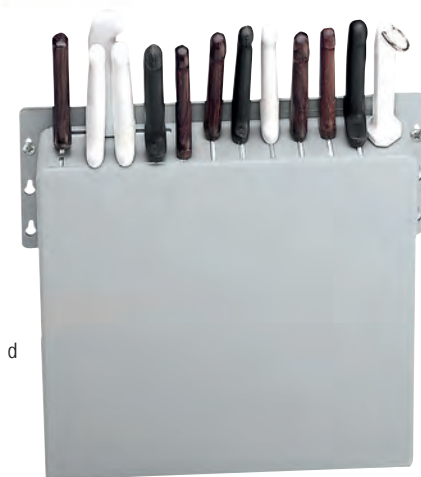

*Cutlery not included

MAGNETIC KNIFE HOLDERS

- Mounting hardware included
- Knives not included



PERFECTGRIP® KNIFE SHARPENER

- Keep knives sharp with a variety of sharpening tools
- Compact designs, easy to store
- Cash and Carry packaging



| Item # | Description | Min Order/ Case Pack |
|---|---|-------------------------|
| CUTTING BOARD RACKS | | |
| a. | CBR6BK Hanging Rack, Black Vinyl Coated Stainless Steel (Holds up to 6 Cutting Boards and Brushes*), 31 x 24 x 25.5cm | 1 ea / 10 ea |
| b. | WSC12 Holding Rack, Stainless Steel, White Feet (Holds 6 Cutting Boards), 26.5 x 34.5 x 26.5cm | 1 ea / 6 ea |
| PERFECTGRIP™ KNIFE SHARPENER - CARBIDE | | |
| c. | *10994 ▶ PerfectGrip™ Handheld Sharpener | 1 ea / 12 ea |
| KNIFE RACK – HIGH IMPACT POLYSTYRENE | | |
| d. | PKR-1 Knife Rack (Holds 12 Knives, 1 Cleaver, 1 Steel, Sharpener), 38 x 40.5 x 7.5cm | 1 ea |
| BLACK MAGNETIC KNIFE HOLDERS – PLASTIC | | |
| | *2913P 34.5cm | 1 ea / 36 ea |
| e. | *2918P 46.5cm | 1 ea / 30 ea |
| | *2924P 62cm | 1 ea / 24 ea |



SKEWERS

STAINLESS STEEL OR BAMBOO

- Perfect for presenting meat or vegetable kebab-style dishes
- Stainless steel option has an oval wire shape to prevent food from spinning
- Bamboo is single-use



b

GRATERS



Non-slip grips for safe and easy use back of house



c



d



e



f

CRINKLE CUT MEZZALUNA



g

- Speed up prep time
- Single-handed ergonomic design allows for a fast and safe rock-and-slice motion
- Blades will cut through firm fruits and vegetables



| Item # | Description | Min Order/ Case Pack |
|--|--|-------------------------|
| SKEWERS – STAINLESS STEEL | | |
| a. 306 | 16cm, Oval | 60 ea |
| 308 | 20.5cm, Oval | 60 ea |
| 312 | 30.5cm, Oval | 60 ea |
| 314 | 35.5cm, Oval | 60 ea |
| SKEWERS – BAMBOO (PACK OF 100) | | |
| 906 | 15cm | 10 pk |
| b. 908 | 20cm | 10 pk |
| 910 | 25cm | 10 pk |
| GRATERS – STAINLESS STEEL, NON-SLIP GRIPS | | |
| c. *SG203BH | Tapered 4-Sided Box Grater, Small, 8.5 x 6 x 15cm | 6 ea |
| d. *SG204BH | 6-Sided Grater, 14.5 x 12 x 24cm | 6 ea |
| e. *SG205BH | Tapered 4-Sided Box Grater, Large, 11 x 8.5 x 24.5cm | 6 ea |
| GRATERS – STAINLESS STEEL | | |
| f. SG200 | Tapered Grater, 10.5 x 8 x 23.5cm | 1 ea / 12 ea |
| MEZZALUNA – STAINLESS STEEL BLADE, POLYPROPYLENE HANDLE | | |
| g. *H6610 | Crinkle Cutter, Single Blade, 19 x 2 x 12.5cm | 6 ea |



BURRITO / TACO FRY BASKETS

- Choice of styles for easy cooking of taco shells, taco cups, tostadas, chimichangas and burritos
- Comfort grip vinyl handle keeps cool when in use



FRENCH FRY RAIL



TACO BOWL FRY BASKET

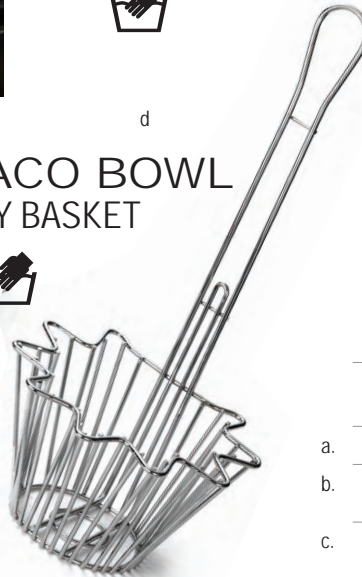

TACO / TOSTODA FRY BASKETS

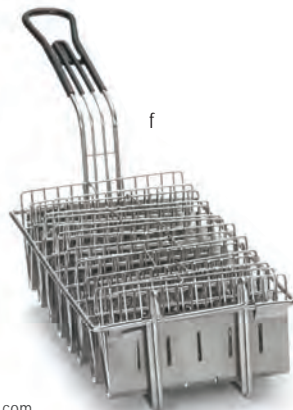

| Item # | Description | Min Order/ Case Pack |
|--|---|-------------------------|
| BURRITO / TACO FRY BASKETS - NICKEL PLATED METAL WITH RED VINYL HANDLE† | | |
| a. | TB1164 Burrito Fry Basket, 56 x 18 x 26.5cm | 1 ea / 6 ea |
| b. | TB60 Holds Six 15cm Taco Shells, 31 x 16.5 x 7cm, with 23cm Handle | 1 ea / 8 ea |
| c. | TB24039 20cm Double Taco Cups Fry Basket, 34 x 16 x 8cm, with 14cm Handle | 1 ea / 12 ea |
| TACO BOWL FRY BASKETS – CHROME PLATED METAL† | | |
| d. | 44080 Deep Basket, 21cm dia x 12cm, with 33cm Handle | 1 ea / 4 ea |
| PREP TRAYS / RAILS – CHROME PLATED METAL † | | |
| e. | 4040 Taco / French Fry Rail Holds Twelve 15 cm Taco Shells | 1 ea / 2 ea |
| TACO / TOSTADA FRY BASKET – CHROME PLATED STEEL, BLACK VINYL HANDLES † | | |
| f. | 40 Holds Eight 15 cm Taco Shells, 31 x 16.5 x 12cm, with 23cm Handle | 1 ea / 8 ea |
| g. | 41 Holds Seventeen 15 cm Tostada Shells, 24 x 16 x 13.5cm, with 20cm Handle | 1 ea / 8 ea |

† Hand Wash Only

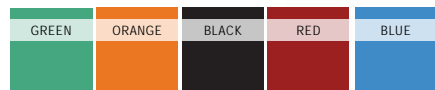

FRY BASKETS

- Colour-coded handles for easy identification
- Comfort grip vinyl handle keeps cool when in use
- Choose from a variety of sizes

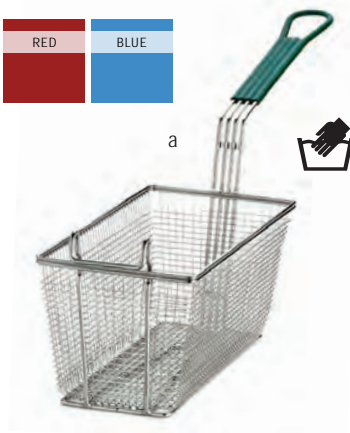

Vinyl Handle Coatings



| Item # | Description | Min Order/ Case Pack |
|--|--|-------------------------|
| FRYER BASKETS – NICKEL PLATED MESH, RECTANGULAR BASKETS † | | |
| a. 42 | 34 x 16.5 x 15cm, with 29cm Green Handle | 1 ea / 12 ea |
| 43 | 31 x 16.5 x 13.5cm, with 29cm Orange Handle | 1 ea / 12 ea |
| 426 | 28 x 14 x 10.5cm, with 27cm Black Handle | 1 ea / 12 ea |
| 427 | 33 x 16.5 x 14cm, with 28cm Red Handle | 1 ea / 12 ea |
| 428 | 34 x 14.5 x 14.5cm, with 29cm Blue Handle | 1 ea / 12 ea |
| FRYER BASKETS – STAINLESS STEEL MESH, RECTANGULAR BASKETS † | | |
| 430 | 34 x 14.5 x 14.5cm, with 29cm Green Handle | 1 ea / 12 ea |
| 431 | 34 x 14.5 x 14.5cm, with 29cm Red Handle | 1 ea / 12 ea |
| ROUND PASTA BASKETS – 18-8 STAINLESS STEEL, BLUE COOL TOUCH VINYL HANDLE | | |
| 984 | 11.5cm dia x 18cm, with 13.5cm Handle | 2 ea |
| b. 985 | 13.5cm dia x 18cm, with 13.5cm Handle | 2 ea |
| c. 986 | 16.5cm dia x 18cm, with 15cm Handle | 2 ea |
| FRENCH FRY SCOOPS – 18-8 STAINLESS STEEL, BAKELITE® HANDLES, HEAT SAFE TO 232°C † | | |
| d. FFD8 | Dual Handle  | 1 ea / 12 ea |
| e. FFR8 | Right Handle  | 1 ea / 12 ea |
| PLASTIC, HEAT SAFE TO 100°C | | |
| f. PD8 | Dual Handle | 1 ea / 6 ea |
| g. PR8 | Right Handle | 1 ea / 6 ea |
| PREP TRAYS/RAILS – CHROME PLATED METAL AND 18-8 STAINLESS STEEL | | |
| h. 937 | Prep Tray, Holds 7 items, 46.5 x 10 x 5.5cm | 1 ea / 24 ea |
| i. BBQ48* | Prep Tray, Holds 4 Items, 28.5 x 15 x 5cm | 6 ea |

† Hand wash only

PASTA BASKETS

- Colour-coded handles for easy identification
- Comfort grip vinyl handle keeps cool when in use
- Choose from a variety of sizes

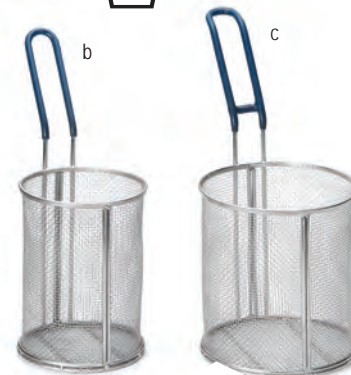

FRENCH FRY SCOOPS



PREP TRAYS / RAILS

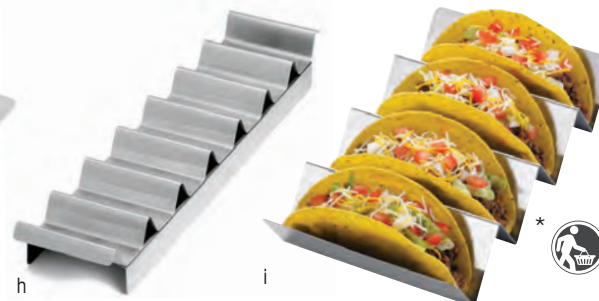

MASH,
SMASH,
SKIM
AND GIVE IT
A GOOD FRY.

MASHERS



SKIMMERS & STRAINERS



| Item # | Description | Min Order/ Case Pack |
|--|--|-------------------------|
| POTATO MASHERS – ASSORTED - STAINLESS STEEL | | |
| a. 7412 | 11.5cm Diamond Face, 34.5cm Length | 1 ea / 12 ea |
| 7418 | 10cm Square Face, 46cm Length | 1 ea / 5 ea |
| b. 7424 | 13.5cm Square Face, 61cm Length | 1 ea / 5 ea |
| 7432 | 13.5cm Square Face, 81cm Length | 1 ea / 5 ea |
| CHROME PLATED STEEL WITH BLACK VINYL HANDLE | | |
| c. 7319 | 11.5cm dia Round Face, 48cm Length | 1 ea / 4 ea |
| SKIMMERS – NICKEL PLATED STEEL | | |
| d. 2409 | Round, Spiral Wire, 23cm dia with 31cm Handle | 1 ea / 12 ea |
| e. 2675 | Rectangular, Fine Mesh Skimmer, 13 x 15cm with 30.5cm Handle | 1 ea / 12 ea |
| f. 2677 | Square, Fine Mesh Skimmer, 17 x 17cm with 34cm Handle | 1 ea / 12 ea |
| g. 3306 | Round, Square Mesh Skimmer, 15cm dia with 34.5cm Handle | 1 ea / 12 ea |
| DOUBLE MESH STRAINERS – TIN PLATED, WOOD HANDLES † | | |
| 84 | 20cm dia, Fine Mesh | 1 ea / 12 ea |
| 87 | 26cm dia, Fine Mesh | 1 ea / 12 ea |
| h. 96 | 16cm dia, Medium Mesh | 1 ea / 12 ea |
| 98 | 20.5cm dia, Medium Mesh | 1 ea / 12 ea |
| 99 | 26cm dia, Medium Mesh | 1 ea / 12 ea |
| SINGLE MESH STRAINERS – TIN PLATED, WOOD HANDLES † | | |
| i. 94 | 20cm dia, Fine Mesh | 1 ea / 12 ea |
| BOUILLON STRAINER – 18-STAINLESS STEEL | | |
| j. 348 | 1.9 L, 21.5cm dia, Fine Mesh | 1 ea / 6 ea |
| REINFORCED STRAINERS – TIN PLATED, DOUBLE MEDIUM MESH, WOOD HANDLES † | | |
| 1022 | 26cm dia, Flat Handle | 1 ea / 6 ea |
| k. 1023 | 29cm dia, Round Handle | 1 ea / 6 ea |
| 1024 | 35cm dia, Round Handle | 1 ea / 6 ea |

† Hand wash only

4 EGG RINGS



| Item # | Description | Min Order/ Case Pack |
|--|----------------------|-------------------------|
| 4 EGG RING – NICKEL PLATED FRAME, NON-STICK RING COATING† | | |
| a. 1240 | 4 Egg Ring, 10cm dia | 1 ea / 2 ea |



MEAT TENDERISER



- Cast aluminium option features coarse teeth on one side and a smooth surface on the other
- Wooden handle option features coarse teeth on one side and fine teeth on the other

| Item # | Description | Min Order/ Case Pack |
|--|---|-------------------------|
| MEAT TENDERISERS—CAST ALUMINIUM | | |
| b. 3005 | Double-Sided, Flatten or Tenderize | 1 ea / 36 ea |
| c. 3016 | Wood Handle, 4-Sided Flatten or Tenderize | 1 ea / 12 ea |
| STEAK WEIGHTS— CAST ALUMINIUM OR CAST IRON, WOOD HANDLES† | | |
| d. 3004 | Cast Aluminium, 21 x 10.5 x 4.5cm | 1 ea / 12 ea |
| e. 3033 | Cast Iron, 21.5 x 10.5 x 7cm | 1 ea / 12 ea |
| f. BBQ3015 | Cast Iron, Round, 17.5cm dia x 8.5cm | 4 ea |

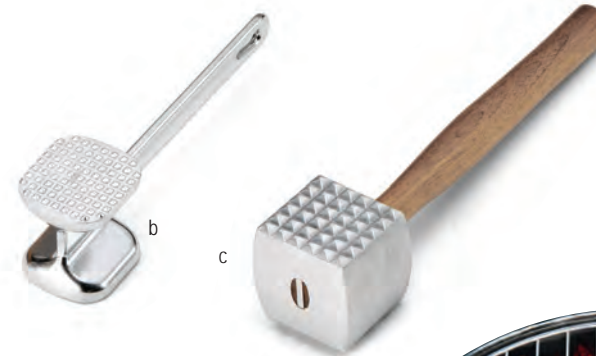

STEAK WEIGHTS

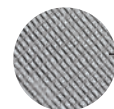

Textured underside



KEEPING
FOODS
SAFELY
UNDER
WRAPS



KENKUT® 3 FILM OR FOIL DISPENSER

- Easy way to dispense film and foil – holds 30.5 to 40.5cm roll width, up to 15cm diameter (915m roll)
- Features a slide cutter and safety blade storage
- Hygienic design, complies to HACCP and food code standards
- Stay-open lid for easy loading, reinforced durable hinge system, wall-mounting option and non-slip feet



| Item # | Description | Min Order/ Case Pack |
|--|--|-------------------------|
| KENKUT® DISPENSER – ABS PLASTIC | | |
| a. KK3 | Film / Foil Dispenser, 56 x 19.5 x 16.5cm | 1 ea |
| REPLACEMENT PARTS & ACCESSORIES | | |
| b. KK3SRB | Film Slide Cutter Blade for KK3 | 1 ea / 44 ea |
| c. RB2 | Metal Blade, 45.5cm | 1 ea / 1000 ea |
| d. KK3CLP | Replacement Retaining Clips, For KK3 Dowel Rod | 1 ea / 1000 ea |

Product support or video training visit: www.kenkut.com

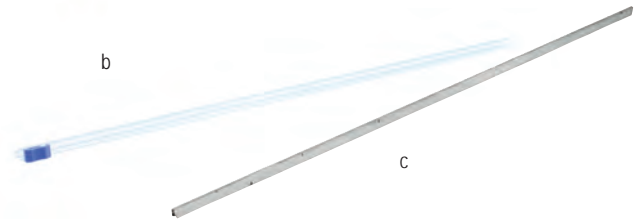

Integrated blade storage

Wall mounting option on back

Integrated handles

Interchangeable slide cutter for film
or metal safety blade for foil

Restraining clip



TIME TO CLEAN UP

GRIDDLE STONE & ACCESSORIES

- Our Griddle Stone Cleaning Blocks grind down during use to make it easy to scour away encrusted dirt and grease, and get into small grooves
- Unlike traditional pumice our Griddle Stone self cleans as it wears down, limiting fatty deposits on the block after each use
- Chemical free, non-toxic and odourless, making it the perfect choice for cleaning your grill
- For best results, scrape surface clean with our Heavy-Duty Grill Scraper (see below) to remove excess residue before use



3119 Griddle Stone & 177 Holder fit together for easy handling

GRILL SCRAPER

- Cut cleanup time in half with our high-quality grill scraper
- Designed for use on flat top grills; scrape off and remove burnt residue, then wipe the grill clean with the attached squeegee
- High heat up to 230°C



| Item # | Description | Min Order/ Case Pack |
|--|---|-------------------------|
| GRIDDLE STONE | | |
| a. 3119 | Griddle Stone Cleaning Block (Case of 12) | 1 cs |
| b. 177 | Griddle Stone Cleaning Block Holder, Aluminium | 1 ea / 6 ea |
| GRILL SCRAPER – ALUMINIUM W/ BLUE STEEL BLADE † | | |
| c. GS181 | Grill Scraper with Squeegee, 35.5cm | 1 ea / 8 ea |
| GS181WS | Heavy Duty Grill Scraper, 35.5cm | 1 ea / 10 ea |
| REPLACEMENT PARTS | | |
| d. GS181RB | Replacement Blade, For GS181 | 1 ea / 25 ea |
| GS181RB-6 | Replacement Blades, For GS181 (pack of 6) | 1 pk |
| e. GS181RP | Replacement Parts, For GS181, Includes (1) U-Bolt, (2) Wing Nuts, (2) Bolts | 1 ea / 50 ea |
| f. GS181SQ | Replacement Squeegee, For GS181 | 1 ea / 12 ea |

† Hand wash only

ORDER
UP...



ORDER HOLDER

- Glass marble design for easy sliding
- Essential addition to all busy service areas
- Wide range of sizes available
- All racks are 2.22cm deep



| Item # | Description | Min Order/ Case Pack |
|-----------------------------------|-------------|-------------------------|
| ORDER HOLDERS – ALUMINIUM† | | |
| 5512 | 30.5cm | 2 ea |
| a. 5518 | 45.5cm | 2 ea |
| 5524 | 61cm | 2 ea |
| 5530 | 76cm | 2 ea |
| 5536 | 91.5cm | 2 ea |
| 5548 | 122cm | 2 ea |
| 5560 | 152.5cm | 2 ea |

FUNNELS – WHITE PLASTIC

| | | |
|------|--|-----------------|
| b. 5 | Funnel Set Includes: 5, 7.5, 10, 12.5, 15cm dia | 1 set / 12 sets |
|------|--|-----------------|

† Hand wash only

PLASTIC FUNNELS





FLATWARE CYLINDERS AND TIERED HOLDERS

- Storage holders for your cutlery and kitchen tools
- Holders not included, sold separately
- All cylinders are available as replacement parts



CUTLERY BINS



| Item # | Description | Min Order/ Case Pack |
|--|--|-------------------------|
| FLATWARE CYLINDERS & TIERED HOLDERS – STAINLESS STEEL, NYLON OR POLYPROPYLENE | | |
| a. 7042 | Stainless Steel, 4 Holes, 31 x 26 x 21.5cm Inserts not included | 1 ea |
| b. 7062 | Stainless Steel, 6 Holes, 38 x 30 x 21cm Inserts not included | 1 ea |
| c. 1010401 | Cylinder, Black, Polypropylene, 11.5cm dia x 14cm | 1 ea / 12 ea |
| d. 34 | Cylinder, Stainless Steel, 11.5cm dia x 13cm | 1 ea / 12 ea |
| CUTLERY BINS | | |
| HIGH DENSITY POLYETHYLENE Safe workload up to 11.3kg | | |
| e. 1524G | Grey, 55 x 30 x 9.5cm | 12 ea |
| f. 1524B | Black, 55 x 30 x 9.5cm | 12 ea |

NSF® OPTION™ DISPENSER

- Prep, store and serve your salad dressings, juices or condiments
- Easy to read labelled ergonomic handles and clear bottles make it simple to identify contents
- Holding tray keeps bottles organised in a cold well. Holder is same size as a full-sized food pan
- Slider prevents drips and keeps countertops clean

1.4 L BPA-free

Set includes (6) dispensers with black plastic tops, (1) tray, (10) different salad dressing tags: Blue Cheese, Fat Free Ranch, Fat Free Italian, French, House, Italian, Ranch, Russian, Thousand Island and Vinaigrette



| Item # | Description | Capacity | Min Order/ Case Pack |
|--|--|-----------|-------------------------|
| NSF® OPTIONS DISPENSER – BPA-FREE BOTTLES | | | |
| a. | N481 Dispenser Set, White Plastic Tray | (6) 1.4 L | 1 set |
| b. | N481BK Dispenser Set, Black Plastic Tray | (6) 1.4 L | 1 set |

| Item # | Description | Capacity | Min Order/ Case Pack |
|-------------------------------------|---|----------|-------------------------|
| ECONOMY PUMP – POLYPROPYLENE | | | |
| c. | 662 1oz Economy Pump, 11.5 x 5 x 41.5cm | 30ml | 1 ea / 12 ea |
| LDPE BOTTLES | | | |
| d. | 32C 32oz Bottle | 950ml | 12 ea |
| HDPE JUGS | | | |
| e. | 1032J 32 oz Jug | 950ml | 12 ea |
| STORAGE CAPS | | | |
| f. | 1017BK Black Cap | | 1 ea / 400 ea |
| | 1017BR Brown Cap | | 1 ea / 400 ea |
| | 1017GN Green Cap | | 1 ea / 400 ea |
| | 1017R Red Cap | | 1 ea / 400 ea |
| | 1017W White Cap | | 1 ea / 400 ea |
| | 1017X Orange Cap | | 1 ea / 400 ea |

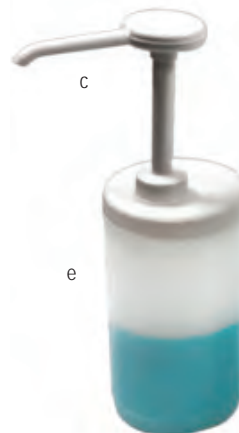

32C:
950ml (32 oz)
LDPE Bottle
(pump not included)

1032J:
950ml (32 oz)
HDPE Jug
(pump not included)



PLASTIC BOTTLES AND STORAGE CAPS

TABLECRAFT RECOMMENDED CARE & USE FOR YOUR PRODUCTS

Acrylic

When cleaning your acrylic pieces, do not use abrasive cloths or paper towels. Always be sure to use a microfiber cloth to prevent scratching. To sanitize, use warm water mixed with sanitizing dish soap, Hydrogen Peroxide (3%-5% Concentration), or a bleach-water solution (2% Concentration of Bleach). To prevent damage to the surface of your acrylic shield, avoid using ammonia or alcohol based cleaners.. Do not put in the dishwasher. Not microwave or oven safe.

Melamine

Dishwasher safe. Due to the size of some pieces, hand washing is best. We recommend to use a soft cloth and mild detergent, then towel dry. Not microwave or oven safe. Safe for temperatures up to 100°C.

Enamelware

Vitreous Porcelain Enamel Coated Steel Enamelware is a time-honored traditional cooking and serving vessel that has been used for centuries in many ways. A good quality enamelware product can last for years under the right conditions and cared for correctly. Just like any other porcelain piece in the market, porcelain enamel coated steel is not chip resistant and can become worn over the years. The steel substrate of the products is incredibly strong; however the porcelain coating is susceptible to chipping if handled roughly or repeatedly dropped on a hard surface.

To extend the life of your enamelware products, we recommend that you wash before use, do not use abrasive cleaning or scouring pads, do not place empty enamelware on heating element or allow to boil dry on induction unit, gas or electric hobs. Also, before use, coat with a light coating of cooking oil to protect the enamelware from staining. After use, to remove baked on food or stains, soak in warm soapy water and wash gently with non-abrasive liquid detergent.

Enamelware products are commercial dishwasher safe (high & low temp), induction and freezer safe, and safe for direct flame. Not microwave safe.

Porcelain

All pieces are dishwasher and microwave safe. We recommend to use a soft cloth and mild detergent, then towel dry.

Polyethylene/Plastic Bottles

Dishwasher safe (low temperature). Not microwave safe.

Recycled Green Glass

Dishwasher safe. Due to the nature of recycled glass, it is common to notice bubbles and small lines in the finished product. These characteristics are natural qualities of recycled glass — no two pieces are exactly alike. Not microwave or oven safe.

Stainless Steel

Dishwasher safe. For best results, we recommend to hand wash with a soft cloth and mild detergent, then towel dry immediately to maximise their beauty. Do not wash with harsh or abrasive cleaners. Do not allow product to soak in water for extended periods of time (will prevent rust). Not microwave safe.

Galvanised Steel

Hand wash with a soft cloth and mild detergent, then towel dry.

Do not wash with harsh or abrasive cleaners. Do not allow product to soak in water for extended periods of time (will prevent rust). Not microwave safe.

Black Metal / Chrome Plated Baskets or Racks

Hand wash with a soft cloth and mild detergent, then towel dry. Do not wash with harsh or abrasive cleaners. Do not put in the dishwasher.

Polypropylene Baskets

Dishwasher safe (low temperature). Not microwave or oven safe.

Ridal Collection™ Baskets

Dishwasher safe (low temperature). Microwaveable for limited reheat use. Not oven safe.

Willow

For best results, we recommend to hand wash with a soft cloth and mild detergent, then towel dry.

Do not wash with harsh or abrasive cleaners. Do not put in the dishwasher.

Polyethylene/Plastic Baskets

Dishwasher safe (low temperature), microwave safe (for re-heat only) and heat lamp safe up to 65°C.

Wood Products (Acacia, Ashwood, Bamboo, bread boards, pepper mills, etc.)

Hand wash with a soft cloth and mild detergent, then towel dry.

Do not wash with harsh or abrasive cleaners. Do not put in the dishwasher. Do not let product soak in water for extended periods of time (prevents splitting).

PROFESSIONAL BAKEWARE RECOMMENDED CARE & USE FOR YOUR PRODUCTS

| Description | Temperature Range in °C | Dishwasher Safe | Only Use Non Caustic Detergents | Oven & Steam Table Safe | Metal Utensil Safe | Metal Scrubbers Safe | Hot Plate Safe |
|------------------------|-------------------------|-----------------|---------------------------------|-------------------------|--------------------|----------------------|----------------|
| Tri-Ply | -28° up to 232° | Yes | No | Yes | Yes | Yes | Yes |
| Stainless | -28° up to 232° | Yes | No | Yes | Yes | Yes | Yes |
| Coated Cast Aluminium | -28° up to 63° | Yes | Yes | No | No | No | No |
| Natural Cast Aluminium | -28° up to 232° | Yes | Yes | Yes | Yes | Yes | Yes |
| Die Cast | -28° up to 232° | Yes | Yes | Yes | Yes | No | Yes |

ETL® Listing

CW40164, CW40162, CW40160, CW30159, CW30157, CW30158.

The ETL Listed Mark is proof of product compliance (electrical, gas and other safety standards) to North America safety standards.

NSF® Listing

This catalogue was produced January 2021. Item listing is constantly updated, please see NSF®.org for the latest listing information.

Stainless Steel (Tri-Ply)

Stainless Steel cookware is dishwasher safe. However, we recommend hand-drying the cookware immediately after the rinse cycle or hand-washing and drying to preserve the original finish. Prolonged exposure to high heat settings may cause your cookware to discolour. To recondition your cookware or to remove stubborn spots and stains, use a nonabrasive pad and quality Stainless Steel cleanser such as Bar Keepers Friend®.

Cast Iron

Our line of Cast Iron is pre-seasoned, however it is still important to seal the surface of cast iron through a process called "seasoning". This makes the cookware less likely to stick, protects it from corrosion and rust, and prevents food from taking on metallic flavors. With proper care, a well seasoned pan will only get better with time and last for years.

To re-season, allow cookware to cool before cleaning. Wash the pan thoroughly in hot soapy water, then hand dry immediately. Using a cloth or paper towel, grease the pan thoroughly with a thin coating of vegetable oil or melted vegetable shortening. Be sure to coat the entire surface, including all corners. Heat the oven to 175°C. Place the cookware in the oven for 1 hour. Remove while hot and allow to cool to room temperature. Wipe away any excess oil, being careful not to scrub clean, then store.

To preserve the seasoned finish, cast iron must be cleaned differently from other types of cookware. Cast Iron should never be placed inside a dishwasher or scrubbed with scouring pads or steel wool. Instead, wipe the pan clean with a sponge or dishcloth in hot water, without detergent. Any residue may be removed by boiling a little salt and vinegar in the pan, or by rubbing with a paper towel and coarse salt. Hand dry immediately after washing and brush with a thin coating of vegetable oil before storing. If stacking pans, place a paper towel between them. Pans should be seasoned from time to time when needed.

Cast Iron (cont.)

Cast iron cookware is heavy and care should be taken when lifting; where available, use side handles for extra stability. Always use heat protection gloves as handles will become hot.

Cast Iron is not microwave safe. Safe to -17°C.

Cast Iron Rust? Don't panic, it's not broken. Without protective seasoning, iron can rust. To fix, scour the rust, rinse, dry, and rub with a little vegetable oil. If problem persists, you will need to thoroughly remove all rust and follow our re-seasoning instructions.

Cast Aluminium–Natural Finish

The "Naturals" are made of a food safe cast aluminium without coating and are NSF® approved. These items can endure temperatures from –28 up to 230°C. For best results, we recommend to hand wash with a soft cloth, then towel dry immediately to maximise their beauty. Staining will occur if acidic foods are put into the natural products.

Cold Serving Cast Aluminium–Coated

All Coated Cast Aluminium products are NSF® approved and will endure temperatures from –28 up to 63°C. (DO NOT BAKE in the coated cast aluminium products). If a defect in the coating appears, such as peeling or chipping, the product must be taken out of service immediately and repaired or replaced. The intended purpose of the colour coated products is for cold serving & display only. They are not to be used in the preparation of food. Some environmental uses are, but not limited to, buffet lines, catered environments, and in food display cases. Do not cut directly on the products, as this will cause the coating to scratch. Do not put any of the products in an oven, on a stove top, under a heat lamp or in any other condition where the temperature exceeds 90°C. Washing by hand is recommended, but when using a non-caustic detergent, the coating is dishwasher safe. Do not clean with scouring pads. Only use nylon or sponge pads. Regular dish washing will dull the coating. Do not use metal utensils on the colour coated products.

NOTE: Staining of all colour coated products will occur especially if used with acidic foods. The lighter (white, sky blue, and grey) colours are more likely to show stains than darker colours. Staining of products is not covered under warranty.

Aluminium

Not Dishwasher Safe. Wash by hand using a cloth, warm water, and dish soap. Dishwashing will cause discoloration of your aluminium kitchenware.

TERMS & CONDITIONS

1. Definitions

- 1.1 'Buyer' means the person who buys or agrees to buy the goods from the Seller.
- 1.2 'Conditions' means the terms and conditions of sale set out in this document and any special terms and conditions agreed in writing by the Seller.
- 1.3 'Delivery Date' means the date specified by the Seller when the goods are to be delivered.
- 1.4 'Goods' means the articles which the Buyer agrees to buy from the Seller.
- 1.5 'Price' means the price for the Goods excluding carriage, packaging, insurance and VAT
- 1.6 'Seller' means Tablecraft Limited.

2. Conditions applicable

- 2.1 These Conditions shall apply to all contracts for the sale of Goods by the Seller to the Buyer to the exclusion of all other terms and conditions including any terms or conditions which the buyer may purport to apply under any purchase order confirmation of order or similar document.
- 2.2 All orders for Goods shall be deemed to be an offer by the Buyer to purchase Goods pursuant to these Conditions.
- 2.3 Acceptance of delivery of the Goods shall be deemed conclusive evidence of the Buyers acceptance of these Conditions.
- 2.4 Any variation to these Conditions (including any special terms and conditions agreed between the parties) shall be inapplicable unless agreed in writing by the Seller. No other agent or representative of the Seller has any authority to vary or omit these conditions in whole or in part.

3. The Price and Payment

- 3.1 Unless a specific alternative price is agreed prior to delivery the Price of the Goods shall be the price stipulated in the Sellers published price list current at the date of delivery of the Goods. The Price is exclusive of VAT which shall be due at the rate ruling on the date of VAT invoice.
- 3.2 Payment of the Price and VAT shall be due in full without set off or counter claim on the last working day of the month following the end of the month in which the Goods are delivered or the invoice issued, whichever is the earlier. Time for payment shall be of the essence.
- 3.3 Interest on overdue invoices shall accrue from the date when payment becomes due from day to day until the date of payment at a rate of 1% above Lloyds Bank plc's base rate from time to time in force and shall accrue at such a rate after as well as before any judgement. The Buyer will also reimburse the Seller for all costs and expenses including solicitors costs incurred in the collection of any overdue amount and whether or not legal proceedings are commenced.
- 3.4 IF the Buyer fails to make any payments on the due date then without prejudice to any of the Seller's other rights the Seller may:
 - 3.4.1 suspend or cancel deliveries of any articles due to the Buyer; and/or
 - 3.4.2 appropriate any payment made by the Buyer to such of the Goods (or Goods supplied under any other contract with the Buyer) as the Seller may in its sole description think fit.
- 3.5 Further miscellaneous provisions:
 - 3.5.1 All purchases must be made in pack sizes as in our published price list
 - 3.5.2 Payment terms in respect of export orders shall be agreed in writing prior to delivery

4. The Goods / Warranties and Liability

- 4.1 The Seller warrants that the Goods will at the time of delivery correspond to the description given by the Seller. Expect where the Buyer is dealing as a consumer (as defined in the Unfair Contract Terms Act 1977 Section 12) all other warranties, conditions or terms relating to fitness for purpose, merchantability or condition of the Goods and whether implied by statute or common law or otherwise are excluded.
- 4.2 Notwithstanding clause 4.1 all drawings specifications product finishes and colour shades in the Sellers catalogue literature and advertisement are approximate and do not constitute a trade description.
- 4.3 The Seller may from time to time make changes in the specification of the Goods which are required to comply with any applicable safety or statutory requirements or which do not materially affect the quality or fitness for purposes of the Goods.
- 4.4 All terms, conditions and warranties (whether implied or made expressly) whether by the Seller or its servants or agents or otherwise (other than those express warranties set out in the current edition of the Sellers specification) relating to the quality and/or fitness for purpose of the Goods or any of the Goods are excluded.
- 4.5 Subject to clause 4.4 the Seller liability to the Buyer shall not in any event exceed the Price and further the Seller shall not be liable for any indirect or consequential loss suffered by the Buyer

5. Delivery of the Goods

- 5.1 Delivery of the Goods shall be made to the Buyer's address on the Delivery Date. The Buyer shall make all arrangements necessary to take delivery of the Goods whenever they are tendered for delivery.
- 5.2 The Seller shall not be liable for any loss or damage whatever due to failure by the Seller to deliver the Goods (or any of them) promptly or at all.
- 5.3 Notwithstanding that the Seller may have delayed or failed to deliver the Goods (or any of them) promptly the Buyer shall be bound to accept delivery and to pay for the Goods in full provided that delivery shall be tendered at any time within 1 month of the Delivery Date.
- 5.4 The Seller may deliver the Goods by separate instalments. Each separate instalment shall be invoiced and paid for in accordance with the provisions in this contract of sale.
- 5.5 The failure of the Buyer to pay for any one or more of the said instalments of the Goods on the due dates shall entitle the Seller (at the sole option of the Seller):
 - 5.5.1 without notice to suspend further deliveries of the Goods pending payment by the Buyer; and/or

5.5.2 to treat this contract as repudiated by the Buyer.

5.6 Unless quoted otherwise UK mainland deliveries are free of charge on all orders over the value of £600 List pricing. Orders under this value will be charged at a set rate at the beginning of each calendar year. All deliveries are on a next day service.

5.7 Outside mainland UK deliveries are charged according to the standard rates set at the beginning of the year by the freight companies assigned to the order unless otherwise agreed.

5.8 The Goods shall be at the Buyer's risk as from delivery.

5.9 Ownership of the goods does not transfer to the buyer until the invoice is paid in full.

6. Acceptance of the Goods

- 6.1 All deliveries must be checked that all boxes are presented and in good condition before signing.
- 6.2 A 'clean' signature prevents any claim against the carriers and may result in any claim being rejected by TableCraft Limited.
- 6.3 The Buyer shall be deemed to have accepted Goods 48 hours after delivery to the Buyer
- 6.4 After acceptance the Buyer shall not be entitled to reject Goods which are not in accordance to the contract.
- 6.5 No claims for shortage or picking errors will be accepted unless received in writing quoting the delivery note number within 48 hours of delivery of the Goods.
- 6.6 Claims in respect of non-delivery shall be made in writing within 7 days of receipt of invoice to which they relate failing which delivery will be deemed and payment will be due in accordance with these conditions.
- 6.7 Damage to any of the Goods must be notified in writing to the Seller within 48 hours of delivery. Any Goods rejected by the Buyer as damaged must be retained in the original packaging and made available for inspection by the Seller or its authorised agent.

7 Return of Goods / Cancellation

- 7.1 Save as agreed by the Seller in writing and in its own absolute discretion no Goods shall be accepted for return.
 - 7.2 In the event of acceptance for return of Standard UK stocked items a handling charge of 25% of the Price shall be applied providing return is made within 30 days. After this date standard UK Stocked items will not be accepted for return. Non-UK Standard stocked catalogue items will be charged at the Price and notwithstanding return of Goods.
 - 7.3 Returned items will only be accepted with the correct authorised returns number for that item. No credit will be given for items returned with no authorised returns or included with another return.
 - 7.4 Goods in an unstable condition or with defaced packaging will not be accepted for return
 - 7.5 All authorised returns must be in their original packaging and in a re-saleable condition and inspected by the Sellers warehouse and authorised only then full a full refund or agreed costs to be credited.
 - 7.6 Risk in the Goods to be returned shall remain with the Buyer until received or collected by the Seller.
 - 7.7 With the consent of the Seller and subject to 7 days notice prior to the delivery Date orders for goods (other than customised goods , specials and non UK Stocked items) may be cancelled or deferred but the Seller reserves the right to charge for any exceptional costs it incurs as a result of such cancellation.
 - 7.8 The Seller may cancel this contract at any time before the Goods are delivered by giving written notice. On giving such notice the Seller shall promptly repay to the Buyer any sums paid in respect of the Price. The Seller shall not be liable for any loss or damage whatever arising from such cancellation.
- ## 8. Remedies of Buyer
- 8.1 Where the Buyer validly rejects any Goods then the Buyer shall have no further rights whatever in respect of the supply to the Buyer of such Goods or the failure by the Seller to supply Goods which conforms to the contract of sale.
 - 8.2 Where the Buyer accepts or has been deemed to have acceptance any Goods then the Seller shall have no liability whatever to the Buyer in respect of those Goods
 - 8.3 The Seller shall not be liable to the Buyer for late delivery or short delivery of the Goods.
- ## 9. Miscellaneous
- 9.1 Any notice required to be served pursuant to this contract of sale shall be in writing and served by first class post or by hand on the Seller at 27 Causeway Road, Earlstrees Industrial Estate, Corby, Northants, NN17 4DU or such other address as the Seller may from time to time notify to the Buyer and on the Buyer at the Buyer's registered office or principal place of business.
 - 9.2 The Seller may licence or sub-contract all or any part of its rights and obligations under this contract without the Buyer's consent.
 - 9.3 Neither party shall be liable for any default due to any act of God, war, strike lockout, industrial action, fire, flood, drought, tempest or other event beyond the reasonable control of either party.
- ## 10. Proper law of contract
- 10.1 This contract is subject to the law of England and Wales.
 - 10.2 The parties submit to the exclusive jurisdiction of the courts of England and Wales and irrevocably agree that proceedings issued out of the said courts may without prejudice to the rules of service of such courts be served on them by delivering such proceedings in an envelope addressed to the party to be served at the address for such party as in Clause 10.1
- ## 11. Statutory Rights
- 11.1 Nothing herein contained shall alter or affect the Buyer's statutory Rights.

©2024 TableCraft Products Company, inc. All rights reserved. No portion of this catalogue may be reproduced without the express written permission of the copyright holder. TableCraft Products Company, Inc. All rights reserved.

Disclaimer

TableCraft is not responsible for printing errors. Product case packs, specifications, terms or conditions of sale are subject to change without notice. All products are subject to standard VAT as set out by the UK government guide lines.

European Office

44(0)1536.400091
44(0)1536.201492 fax
salesuk@TableCraft.com

European Representatives

Germany

Lentz International
49.171.54.46.660
marc@lentz-international.de

Greece

Fornaro Business Agency
30.210.3235435
30.210.3225429 fax
Irene@fornaro.gr

Italy

F.S.G. Italia
39.0522.902.051
39.0522.902.017 fax
info@fsg-italia.it

Portugal

Hotel Restaurant Co
351.918.550.429
jq@hotelrestaurantco.com

CIS

Marina Plyaskina
7495.668.70.69
tablecraft@combocom.ru

Scandinavia

SMAG
47.4174.9926
47.9477.5454 fax
anders@smag.no

International Representatives

Canada

W.D. Colledge Co. Ltd.
905.677.4428 | 877.677.4428
905.677.5357 fax
cjeens@wcdcolledge.com

Mexico, Caribbean, Central America

Johnson Sales Company
954.927.3900
954.927.3909 fax
Johnson@johnsonsalesco.com

New Zealand, Sub-Saharan Africa,

Indian & Pacific Ocean Isles
Jack Warren
+27 76 042 8199
jack@warrenint.com

Southeast Asia & China

CP Solutions (Asia) Company
Limited
852.2621.3001
852.2621.3002 fax
michael@cp-asia.com

U.S. Representatives

Carolina Foodservice Solutions

984.235.7767
info@
carolinafoodservicesolutions.com
North Carolina, South Carolina

Ellsworth

Marketing Associates
678.691.8104
678.691.8105 fax
rellsworth@ellsworthmarkassoc.com
Georgia, East Tennessee,
Alabama, Florida Panhandle

Finn Foodservice

800.451.6755
(813) 925-1607 fax
jay@FinnFS.com
Florida (Except Panhandle)

Forbes Hever & Wallace, Inc.

800.526.1126
orders@your-rep.com
Texas (Except El Paso), Oklahoma

Elevate Foodservice Group

617.546.2360
connect@elevatefsg.com
Massachusetts, New Hampshire,
Rhode Island, Maine, Vermont,
Connecticut

Greenwald Sales & Marketing

614.404.7733
melissa@greenwaldsales.com
Ohio, West Virginia, Indiana,
Kentucky

KC Marketing

412-638-1112
kcmarketing2022@gmail.com
Western Pennsylvania

Lane Marketing Group

410-974-1108
anne@lanegroup.com
Maryland, District of Columbia,
Virginia

Lake Effect Sales & Marketing

(716) 998-5963
davea@lakeeffectfs.com
Upstate New York

Mancini And Associates, Inc.

610.659.1716
manciniandassociates@comcast.net
Eastern Pennsylvania, Delaware,
Southern New Jersey

Mid-West Associates

586.263.1229
mike@midwestassociates.net
Michigan

Mirkovich and Associates

630.792.0080
630.792.9914 fax
Ed@mirkovich.com
Richard@mirkovich.com
Northern Illinois, Northwest
Indiana, Eastern WI

NorthStar Agency

612.751.2886
ben@northstaragency.com
Minnesota, Western Wisconsin,
North & South Dakota

EMC

503.998.4599
michaelh@emchospitality.com
Pacific Northwest, Idaho,
Montana,
Northern & Southern California,
Northern Nevada, Las Vegas,
Hawaii

P3 Reps

201.797.2266
(201) 797-2266 fax
kim@p3reps.com
New York Metro,
Northern New Jersey

The Pinnacle Group

314.770.2044
314.770.2435 fax
heather@tpgreps.com
Missouri, Iowa, Nebraska,
Kansas, Southern Illinois

Curate

303.373.1940
303.371.1557 fax
info@curateteam.com
Utah, Colorado, Wyoming,
Texas (El Paso), Arizona, New
Mexico

Wallin Foodservice Resources

504.733.3344
504.733.0854 fax
brent@wallinfsr.com
Mississippi, Louisiana, Arkansas,
Western Tennessee

WANTING **More?**

EU.TABLECRAFT.COM

Or follow us on social media:



/tablecraftEU



@tablecraftEU



@tablecraftEU



/tablecraft-products-company



TABLECRAFT NUMERIC INDEX

| | | | | | | | | | | | | | |
|---------|----------|----------|---------|---------|------------|----------|-----|--------|-----|----------|-----|----------|---------|
| 5 | 155 | 85 | 42 | 406 | 79 | 852F | 43 | 1174W | 103 | 3016 | 151 | 5488 | 72 |
| 12SV | 118 | 87 | 150 | 421 | 30 | 906 | 147 | 1175W | 103 | 3033 | 151 | 5488W | 72 |
| 16SV | 118 | 94 | 150 | 422 | 30 | 908 | 147 | 1176W | 103 | 3119 | 154 | 5512 | 155 |
| 21 | 111 | 95 | 64 | 426 | 149 | 910 | 147 | 1177W | 103 | 3263C | 120 | 5518 | 155 |
| 22 | 111 | 96 | 150 | 427 | 149 | 913A | 90 | 1188W | 103 | 3263C3 | 122 | 5524 | 155 |
| 23 | 112 | 98 | 150 | 428 | 149 | 913AS | 90 | 1189W | 103 | 3306 | 150 | 5530 | 155 |
| 23BK | 112 | 99 | 150 | 430 | 149 | 916 | 77 | 1192W | 103 | 3711 | 134 | 5536 | 155 |
| 24 | 112 | 100TC | 124 | 431 | 149 | 916R | 77 | 1218BK | 67 | 3712BKEU | 135 | 5548 | 155 |
| 24BK | 112 | 100TK | 124 | 461BKEU | 143 | 918 | 76 | 1240 | 151 | 3712BLEU | 135 | 5560 | 155 |
| 24SV | 119 | 100TM | 124 | 501K | 64 | 918R | 76 | 1370G | 78 | 3712GEU | 135 | 5834 | 67 |
| 30S&P | 81 | 101 | 70 | 512 | 66 | 937 | 149 | 1370T | 78 | 3712REU | 135 | 6618 | 83 |
| 32C | 124, 157 | 102 | 69 | 513 | 79 | 984 | 149 | 1471 | 103 | 3712YEU | 135 | 6619 | 83 |
| 32SV | 119 | 103 | 69 | 514 | 79 | 985 | 149 | 1474 | 103 | 3715 | 134 | 6702 | 141 |
| 34 | 156 | 104 | 69 | 515 | 79 | 986 | 149 | 1475 | 103 | 3716BKEU | 135 | 6703 | 141 |
| 35BK | 62 | 105 | 68, 70 | 518 | 112 | 1006AS | 90 | 1500 | 131 | 3716BLEU | 135 | 6704 | 141 |
| 35G | 62 | 107 | 68, 70 | 519 | 112 | 1017BK | 157 | 1510 | 131 | 3716GEU | 135 | 6705 | 141 |
| 35R | 62 | 131B | 72 | 522 | 79 | 1017BR | 157 | 1514 | 131 | 3716REU | 135 | 6706 | 141 |
| 35W | 62 | 132S&P-2 | 81 | 526T | 64 | 1017GN | 157 | 1516 | 131 | 3716YEU | 135 | 6708 | 141 |
| 40 | 148 | 146A | 62 | 557TCH | 91 | 1017R | 157 | 1524B | 156 | 3774BKEU | 135 | 7042 | 156 |
| 41 | 148 | 150S&P-2 | 81 | 597P | 62, 76, 80 | 1017W | 157 | 1524G | 156 | 3774BLEU | 135 | 7062 | 156 |
| 42 | 149 | 154S&P-2 | 81 | 598P | 62 | 1017X | 157 | 1602 | 70 | 3774GEU | 135 | 7319 | 150 |
| 43 | 149 | 155S&P-2 | 81 | 599P | 76, 77, 80 | 1022 | 150 | 1603 | 70 | 3774REU | 135 | 7412 | 150 |
| 53FCAP | 118 | 156S&P-2 | 81 | 600 | 77 | 1023 | 150 | 1604 | 70 | 3774YEU | 135 | 7418 | 150 |
| 53FCAPA | 118 | 159 | 133 | 600N | 77 | 1024 | 150 | 1605 | 70 | 4009BK | 135 | 7424 | 150 |
| 53TBL | 120 | 163S&P-2 | 81 | 600T | 78 | 1032J | 157 | 1606 | 70 | 4012BK | 135 | 7432 | 150 |
| 53TC | 120 | 163T | 81 | 605 | 66 | 1071BK | 106 | 1607 | 70 | 4016BK | 135 | 7704 | 141 |
| 53TK | 120 | 166A | 133 | 611 | 80 | 1071R | 106 | 1802 | 62 | 4040 | 148 | 8032 | 61 |
| 53TM | 120 | 166C | 133 | 611N | 80 | 1073BK | 107 | 1862 | 131 | 4100BKEU | 143 | 8032A | 61 |
| 53TSVN | 118 | 166D | 133 | 612 | 66 | 1073FG | 107 | 1863 | 131 | 4100S | 143 | 8032BKBK | 61 |
| 55S-4 | 84 | 166F | 133 | 615 | 76 | 1073R | 107 | 1864 | 131 | 4103W | 143 | 8064 | 61 |
| 55T | 78 | 172 | 112 | 624 | 66 | 1074BK | 106 | 1865 | 131 | 4104BKEU | 143 | 8064A | 61 |
| 56B | 85 | 177 | 154 | 638 | 66 | 1074BK-6 | 106 | 1866 | 131 | 4106W | 143 | 8128A | 61 |
| 56C | 85 | 237 | 51 | 658 | 66 | 1074BL | 106 | 1867 | 131 | 4206 | 133 | 8381 | 112 |
| 60EU | 113 | 242 | 143 | 662 | 157 | 1074BR | 106 | 2003 | 143 | 4208 | 133 | 9085 | 77 |
| 61EU | 113 | 242BKEU | 143 | 667 | 68 | 1074FG | 106 | 2009 | 134 | 4210 | 133 | 9085R | 77 |
| 61EUA | 113 | 242W | 143 | 685 | 66 | 1074G | 106 | 2012 | 134 | 4212 | 133 | 9085RBK | 77 |
| 63EU | 113 | 251BKEU | 143 | 693 | 23 | 1074R | 106 | 2014 | 51 | 4214 | 133 | 9803 | 93 |
| 63EUA | 113 | 251W | 143 | 705 | 131 | 1074R-6 | 106 | 2016 | 134 | 4244A | 62 | 9805 | 93 |
| 63FCAP | 119, 121 | 253BKEU | 143 | 707B | 72 | 1074Y | 106 | 2024 | 51 | 4701 | 134 | 9808 | 93 |
| 63FCAPA | 119 | 253W | 143 | 708 | 131 | 1075BK | 107 | 2036 | 51 | 4702 | 134 | 9812 | 93 |
| 63TC | 120, 121 | 254 | 143 | 712 | 134 | 1075FG | 107 | 2108 | 137 | 4703 | 134 | 10006 | 70 |
| 63TC3 | 121, 122 | 260 | 84 | 713 | 131 | 1075R | 107 | 2110 | 137 | 4704 | 134 | 10007 | 70 |
| 63TK | 120 | 260SL | 84 | 716 | 134 | 1076BK | 106 | 2116 | 137 | 4706 | 134 | 10034 | 98 |
| 63TM | 120 | 295X | 62 | 722 | 136 | 1076BR | 106 | 2120 | 137 | 4708 | 134 | 10035 | 98 |
| 64E | 51 | 300 | 49 | 724 | 136 | 1076FG | 106 | 2124 | 137 | 4712 | 134 | 10036 | 98 |
| 65EU | 113 | 306 | 147 | 725 | 136 | 1076R | 106 | 2130 | 137 | 4937 | 70 | 10037 | 98 |
| 65EUA | 113 | 308 | 147 | 753BK | 67 | 1077BK | 107 | 2132C | 123 | 5063 | 92 | 10038 | 98 |
| 66EU | 113 | 312 | 147 | 797 | 39 | 1077BR | 107 | 2303 | 51 | 5064 | 92 | 10039 | 98 |
| 66EUA | 113 | 314 | 147 | 800-4 | 84 | 1077R | 107 | 2409 | 150 | 5066 | 92 | 10040 | 98 |
| 67EU | 113 | 320A | 62 | 821U | 30 | 1079BK | 107 | 2504 | 39 | 5067 | 92 | 10041 | 98 |
| 70 | 43 | 320C | 62 | 822 | 131 | 1079FG | 107 | 2508 | 39 | 5068 | 92 | 10042 | 98 |
| 70F | 43, 46 | 330 | 62 | 823 | 131 | 1079R | 107 | 2510 | 131 | 5071 | 92 | 10043 | 98 |
| 74 | 134 | 345 | 62 | 824 | 131 | 1084BK | 106 | 2512 | 39 | 5072 | 92 | 10050 | 33, 141 |
| 75 | 42 | 348 | 150 | 825 | 131 | 1084R | 106 | 2514 | 131 | 5073 | 92 | 10051 | 33, 141 |
| 75F | 42 | 353DP | 43 | 826 | 131 | 1086BK | 106 | 2516 | 131 | 5122 | 67 | 10052 | 33, 141 |
| 75FM | 42 | 357 | 83 | 827 | 131 | 1086R | 106 | 2675 | 150 | 5132 | 67 | 10053 | 33, 141 |
| 76 | 63 | 363TC | 121 | 828 | 131 | 1102 | 123 | 2677 | 150 | 5142 | 67 | 10054 | 33, 141 |
| 77 | 63 | 364 | 49, 66 | 830 | 131 | 1104 | 123 | 2712 | 134 | 5188 | 73 | 10055 | 33, 141 |
| 83P | 81 | 375 | 63 | 833 | 88 | 1112C | 123 | 2716 | 134 | 5198 | 73 | 10076 | 100 |
| 83S | 81 | 376 | 63 | 839 | 89 | 1112K | 123 | 2774 | 134 | 5200 | 67 | 10077 | 100 |
| 83S&P | 81 | 377 | 63 | 840 | 89 | 1112KMC | 123 | 2913P | 146 | 5222 | 67 | 10078 | 100 |
| 83T | 81 | 396 | 64 | 843 | 89 | 1112M | 123 | 2918P | 146 | 5232 | 67 | 10079 | 100 |
| 83T1 | 81 | 398 | 72 | 846 | 88 | 1155 | 85 | 2924P | 146 | 5242 | 67 | 10080 | 100 |
| 83TP | 81 | 401 | 50, 139 | 848 | 89 | 1157 | 85 | 3004 | 151 | 5288 | 73 | 10081 | 100 |
| 84 | 150 | 402 | 50, 139 | 850 | 88 | 1171W | 103 | 3005 | 151 | 5398 | 73 | 10090 | 45 |

TABLECRAFT NUMERIC INDEX

| | | | | | | | | | | | | | |
|--------------|-----|----------------|----------|----------------|-----|----------------|---------|-----------------|--------------|----------------|------------|------------------|-----|
| 10162BK..... | 122 | 10553..... | 58 | 10995..... | 128 | 11638..... | 34 | 11868..... | 55 | BAMDCP1..... | 38 | BKDIA728..... | 85 |
| 10173..... | 46 | 10554..... | 58 | 10996..... | 128 | 11639..... | 34 | 11869..... | 55 | BAMDCP2..... | 38 | BKP4..... | 91 |
| 10217..... | 60 | 10555..... | 58 | 10997..... | 128 | 11640..... | 34 | 11884..... | 29 | BAMF35..... | 36 | BKR4..... | 25 |
| 10262..... | 46 | 10556..... | 58 | 11000..... | 18 | 11641..... | 34 | 11885..... | 29 | BAMH6..... | 36 | BLEU..... | 37 |
| 10263..... | 85 | 10557..... | 58 | 11207..... | 129 | 11642..... | 34 | 11886..... | 29 | BAMH45..... | 36 | BSC0610..... | 66 |
| 10285A..... | 60 | 10558..... | 58 | 11208..... | 129 | 11655..... | 90 | 11887..... | 29 | BAMK7..... | 36 | BSC1216..... | 66 |
| 10286BR..... | 60 | 10559..... | 58 | 11209..... | 129 | 11656..... | 90 | 12159..... | 92 | BAMK35..... | 36 | BSC2024..... | 66 |
| 10286GN..... | 60 | 10560..... | 58 | 11210..... | 129 | 11657..... | 98 | 12160..... | 92 | BAMK45..... | 36 | BT1914..... | 47 |
| 10286R..... | 60 | 10561..... | 58 | 11211..... | 129 | 11658..... | 98 | 12463C3..... | 122 | BAML7..... | 36 | BT2013..... | 47 |
| 10286W..... | 60 | 10562..... | 58 | 11253C-12..... | 120 | 11659..... | 97 | 12463C3F..... | 121 | BAML35..... | 36 | BT2137N..... | 47 |
| 10286X..... | 60 | 10626..... | 46 | 11253K-12..... | 120 | 11660..... | 97 | 12463C-12..... | 120 | BAMLPA45..... | 36 | BTB1610..... | 47 |
| 10286Y..... | 60 | 10709..... | 13, 94 | 11253M-12..... | 120 | 11663C3..... | 122 | 12463CF..... | 121 | BAMP5G..... | 37 | C12SV..... | 118 |
| 10289..... | 88 | 10710..... | 13, 94 | 11291..... | 101 | 11663C3F..... | 121 | 12463K-12..... | 120 | BAMP7..... | 37 | C16SV..... | 118 |
| 10290..... | 88 | 10711..... | 94 | 11292..... | 101 | 11663C-12..... | 120 | 12463M-12..... | 120 | BAMP35..... | 37 | C24SV..... | 119 |
| 10291..... | 88 | 10727..... | 122 | 11293..... | 101 | 11663CF..... | 121 | 13759BK..... | 107 | BAMP35A..... | 37 | C56W..... | 85 |
| 10292..... | 88 | 10746..... | 13, 95 | 11294..... | 101 | 11663K-12..... | 120 | 15759BK..... | 107 | BAMP35G..... | 37 | C57S-4..... | 84 |
| 10303..... | 88 | 10764..... | 13, 95 | 11295..... | 101 | 11663M-12..... | 120 | 20002..... | 71 | BAMP45..... | 37 | C100TA..... | 124 |
| 10308..... | 85 | 10765..... | 17, 111 | 11296..... | 101 | 11688..... | 31 | 20005..... | 90 | BAMP45A..... | 37 | C100TBK..... | 124 |
| 10309..... | 85 | 10766..... | 17, 111 | 11297..... | 101 | 11689..... | 82 | 31763C..... | 121 | BAMP45PR..... | 37 | C100TC..... | 124 |
| 10360..... | 45 | 10778..... | 56 | 11298..... | 101 | 11692..... | 21 | 32563C..... | 121 | BAMP45VG..... | 37 | C170-12..... | 80 |
| 10361..... | 46 | 10779..... | 56 | 11299..... | 101 | 11693..... | 21 | 39100..... | 33, 141 | BAMPS6..... | 37 | C3263C..... | 120 |
| 10399..... | 111 | 10780..... | 56 | 11300..... | 101 | 11694..... | 21 | 39101..... | 33, 141 | BAMPS45..... | 37 | C10853C..... | 120 |
| 10422..... | 6 | 10781..... | 56 | 11301..... | 101 | 11695..... | 21 | 39102..... | 33, 141 | BAMSP145..... | 36 | C10853K..... | 120 |
| 10423..... | 6 | 10784..... | 56 | 11401..... | 66 | 11696..... | 21 | 39105..... | 141 | BAMSP245..... | 36 | C10853M..... | 120 |
| 10424..... | 6 | 10785..... | 56 | 11402..... | 66 | 11697..... | 54 | 40400..... | 50, 139 | BAMSP345..... | 36 | C11253C..... | 120 |
| 10425..... | 6 | 10786..... | 56 | 11403..... | 66 | 11698..... | 54 | 40401..... | 50, 136, 139 | BAMSP545..... | 36 | C11253K..... | 120 |
| 10426..... | 6 | 10787..... | 56 | 11404..... | 66 | 11699..... | 54 | 40402..... | 50, 136, 139 | BAMSP645..... | 36 | C11253M..... | 120 |
| 10427..... | 6 | 10788..... | 57 | 11405..... | 66 | 11758..... | 50 | 44080..... | 148 | BBQ48..... | 149 | C11663C..... | 120 |
| 10428..... | 6 | 10789..... | 57 | 11435..... | 93 | 11784..... | 22 | 60125..... | 77 | BBQ3015..... | 151 | C12463C..... | 120 |
| 10429..... | 6 | 10790..... | 57 | 11436..... | 93 | 11785..... | 22 | 123494..... | 45 | BCD1400..... | 68 | C12463K..... | 120 |
| 10430..... | 6 | 10791..... | 57 | 11437..... | 93 | 11786..... | 22 | 123495..... | 45 | BCD6000..... | 69 | C12463M..... | 120 |
| 10431..... | 6 | 10794..... | 57 | 11440..... | 28 | 11787..... | 22 | 123496..... | 45 | BCD6000BK..... | 69 | CB1218BLA..... | 145 |
| 10432..... | 6 | 10795..... | 57 | 11441..... | 28 | 11794..... | 18 | 123497..... | 45 | BDCHBD..... | 46 | CB1218BRA..... | 145 |
| 10433..... | 6 | 10796..... | 57 | 11442..... | 28 | 11795..... | 17 | 157510BK..... | 107 | BDG1000..... | 45 | CB1218GNA..... | 145 |
| 10434..... | 6 | 10797..... | 57 | 11443..... | 28 | 11796..... | 17 | 157510R..... | 107 | BDG2000..... | 45 | CB1218RA..... | 145 |
| 10435..... | 6 | 10820..... | 104 | 11447..... | 16 | 11797..... | 16 | 240010..... | 92 | BDG3000..... | 45 | CB1218WA..... | 145 |
| 10436..... | 6 | 10821..... | 104 | 11448..... | 16 | 11798..... | 16 | 821422..... | 30 | BDGF..... | 42, 45, 46 | CB1218YA..... | 145 |
| 10437..... | 6 | 10822..... | 104 | 11519..... | 30 | 11814..... | 55 | 1010401..... | 156 | BDGR1..... | 46 | CB1824BLA..... | 145 |
| 10438..... | 6 | 10853C-12..... | 120 | 11522..... | 102 | 11815..... | 55 | AC885H..... | 93 | BDGR2..... | 46 | CB1824BRA..... | 145 |
| 10439..... | 6 | 10853K-12..... | 120 | 11523..... | 102 | 11816..... | 55 | AC885S..... | 93 | BDGTUB..... | 46, 47 | CB1824GNA..... | 145 |
| 10454..... | 11 | 10853M-12..... | 120 | 11524..... | 102 | 11817..... | 55 | ACAMBB1507..... | 100 | BH2..... | 78 | CB1824RA..... | 145 |
| 10462..... | 105 | 10904..... | 58 | 11525..... | 102 | 11819..... | 55 | ACAMR14..... | 100 | BH3..... | 78 | CB1824WA..... | 145 |
| 10463..... | 105 | 10924..... | 82 | 11559..... | 8 | 11820..... | 55 | ACAMR2007..... | 100 | BH7..... | 78 | CB1824YA..... | 145 |
| 10464..... | 105 | 10925..... | 82 | 11560..... | 8 | 11821..... | 55 | ACARD16..... | 100 | BH855..... | 78 | CBG1218ABL..... | 144 |
| 10468..... | 59 | 10973..... | 64, 128 | 11561..... | 8 | 11822..... | 55 | AM3709BL..... | 135 | BIEN CUIT..... | 37 | CBG1218ABR..... | 144 |
| 10469..... | 59 | 10974..... | 128 | 11562..... | 8 | 11824..... | 55 | AM3709G..... | 135 | BK155..... | 85 | CBG1218AGN..... | 144 |
| 10470..... | 59 | 10975..... | 128 | 11563..... | 8 | 11825..... | 55 | AM3716BK..... | 135 | BK11709..... | 104 | CBG1218APR..... | 144 |
| 10471..... | 59 | 10976..... | 128 | 11564..... | 6 | 11826..... | 55 | AM3716G..... | 135 | BK17209..... | 104 | CBG1218ARD..... | 144 |
| 10472..... | 59 | 10977..... | 128 | 11575..... | 39 | 11827..... | 55 | AM3716Y..... | 135 | BK17409..... | 104 | CBG1218AWH..... | 144 |
| 10473..... | 59 | 10978..... | 128 | 11576..... | 39 | 11828..... | 19 | AM5301BK..... | 33, 139 | BK17410..... | 104 | CBG1218AYL..... | 144 |
| 10474..... | 59 | 10979..... | 128 | 11577..... | 39 | 11829..... | 19 | AM5302BK..... | 33, 139 | BK17506..... | 104 | CBG1520ABR..... | 144 |
| 10475..... | 59 | 10980..... | 128 | 11622..... | 17 | 11830..... | 19 | AM5303BK..... | 33, 139 | BK17508..... | 104 | CBG1520AGN..... | 144 |
| 10486..... | 98 | 10981..... | 128 | 11623..... | 17 | 11832..... | 82 | AM5304BK..... | 33, 139 | BK17510..... | 104 | CBG1520APK4..... | 144 |
| 10487..... | 98 | 10982..... | 128 | 11626..... | 34 | 11834..... | 32, 142 | AM5306BK..... | 33, 139 | BK37109..... | 105 | CBG1824ABR..... | 144 |
| 10488..... | 98 | 10983..... | 128 | 11627..... | 34 | 11835..... | 32, 142 | A POINT..... | 37 | BK37408..... | 105 | CBG1824AGN..... | 144 |
| 10520..... | 59 | 10984..... | 128 | 11628..... | 34 | 11836..... | 32, 142 | BAD1500..... | 43 | BK37409..... | 105 | CBR6BK..... | 146 |
| 10534..... | 105 | 10985..... | 128 | 11629..... | 34 | 11837..... | 32, 142 | BAMDB3..... | 38 | BK37515..... | 105 | CH2..... | 39 |
| 10535..... | 105 | 10986..... | 128 | 11630..... | 34 | 11838..... | 32, 142 | BAMDB5..... | 38 | BK171172..... | 104 | CH5..... | 39 |
| 10536..... | 105 | 10987..... | 128 | 11631..... | 34 | 11839..... | 32, 142 | BAMDB8..... | 38 | BK171182..... | 104 | CHX4..... | 39 |
| 10537..... | 105 | 10989..... | 128 | 11632..... | 34 | 11840..... | 32, 142 | BAMDB45..... | 38 | BK171372..... | 104 | CR3..... | 25 |
| 10545..... | 90 | 10990..... | 128 | 11633..... | 34 | 11841..... | 32, 142 | BAMDB65..... | 38 | BKC2202..... | 39 | CRATE11..... | 14 |
| 10546..... | 90 | 10991..... | 128 | 11634..... | 34 | 11842..... | 32, 142 | BAMDCB35..... | 36 | BKC2206..... | 39 | CRATE11BK..... | 14 |
| 10547..... | 90 | 10992..... | 128 | 11635..... | 34 | 11846..... | 21, 125 | BAMDCN5..... | 38 | BKC2208..... | 39 | CRATE11W..... | 14 |
| 10548..... | 90 | 10993..... | 128 | 11636..... | 34 | 11847..... | 21, 125 | BAMDCN6..... | 38 | BKC2212..... | 39 | CRATE12..... | 14 |
| 10552..... | 58 | 10994..... | 128, 146 | 11637..... | 34 | 11867..... | 55 | BAMDCN7..... | 38 | BKDIA595..... | 85 | CRATE12BK..... | 14 |

TABLECRAFT NUMERIC INDEX

| | | | |
|------------------|------------|-----------------|--------|
| CRATE12W..... | 14 | FSR3..... | 95 |
| CRATE13..... | 14 | FTR1711..... | 91 |
| CRATE13BK..... | 14 | GHB10..... | 71 |
| CRATE13W..... | 14 | GHB16..... | 71 |
| CRATE14..... | 14 | GHB24..... | 71 |
| CRATE14W..... | 14 | GHC10..... | 71 |
| CRATE114..... | 14 | GHC16..... | 71 |
| CRATE114BK..... | 14 | GHC24..... | 71 |
| CRATE116..... | 14 | GM1212..... | 23 |
| CRATE124..... | 14 | GM1519..... | 23 |
| CRATE126..... | 14 | GM1608..... | 23 |
| CRATE134..... | 14 | GM2113..... | 23 |
| CRATE136..... | 14 | GMT2412..... | 23 |
| CRATESB11..... | 15 | GMT13105..... | 23 |
| CRATESB11BK..... | 15 | GMT21125..... | 23 |
| CST363B-1..... | 72 | GPSS8..... | 97 |
| CW2030..... | 10 | GPSS10..... | 97 |
| CW2032..... | 10 | GPSS89..... | 97 |
| CW2034..... | 10 | GPSS90..... | 97 |
| CW2034L..... | 10 | GPSS96..... | 97 |
| CW2042..... | 10 | GPSS120..... | 97 |
| CW2044..... | 10 | GPSS129..... | 97 |
| CW7000..... | 10, 89 | GPSSCADDY..... | 97 |
| CW7000L..... | 10, 89 | GRSS1..... | 92, 97 |
| CW7000LM..... | 89 | GRSS2..... | 92, 97 |
| CW7010..... | 10 | GRSS3..... | 92, 97 |
| CW7012..... | 10 | GS181..... | 154 |
| CW7014..... | 10 | GS181RB..... | 154 |
| CW7020..... | 10 | GS181RB-6..... | 154 |
| CW30100..... | 12, 95 | GS181RP..... | 154 |
| CW30102..... | 13, 95 | GS181SQ..... | 154 |
| CW30104..... | 13, 95 | GS181WS..... | 154 |
| CW30108..... | 12, 95 | GT2313..... | 47 |
| CW30110..... | 13, 95 | GTSS4..... | 97 |
| CW30112..... | 13, 95 | GTSS28..... | 97 |
| CW30114..... | 12, 94 | GTSS31..... | 97 |
| CW30116..... | 12, 94 | GTSS33..... | 97 |
| CW30118..... | 12, 94 | GTSS44..... | 97 |
| CW30122..... | 12, 95 | GTSS45..... | 97 |
| CW30124..... | 12, 95 | GTSS87..... | 97 |
| CW30140..... | 13, 95 | GTSS375..... | 97 |
| CW30142..... | 13, 95 | GTSS2313..... | 47 |
| CW30148..... | 13, 95 | GTSS2313AT..... | 47 |
| CW30150..... | 13, 95 | GTSS2313CT..... | 47 |
| CW30151..... | 13, 95 | GTSS2313N..... | 47 |
| CW30152..... | 12, 94, 95 | GTSS2313S..... | 47 |
| CW40297..... | 8 | H15S&P..... | 80 |
| CW60100..... | 4 | H77..... | 63 |
| CW60101..... | 4 | H119Y..... | 64 |
| CW60103..... | 4 | H158..... | 133 |
| CWA12..... | 4 | H159..... | 133 |
| CWA20..... | 4 | H211..... | 63 |
| CWDC1030..... | 11 | H320C..... | 62 |
| CWDC1040..... | 11 | H398..... | 72 |
| CWDC1050..... | 11 | H475S&P..... | 80 |
| CWDC1070..... | 11 | H475ST..... | 80 |
| DCBK..... | 62 | H475T..... | 80 |
| DCH01..... | 39 | H501K..... | 64 |
| DCH27..... | 39 | H503K..... | 64 |
| DCL..... | 62 | H633..... | 65 |
| FC1649..... | 23 | H714CH..... | 51 |
| FCB1218A..... | 145 | H820P..... | 30 |
| FFD8..... | 149 | H820P422..... | 30 |
| FFR8..... | 149 | H916N..... | 77 |
| FLIGHT1..... | 71 | H918N..... | 76 |

| | |
|----------------|---------|
| H931..... | 80 |
| H1206..... | 63 |
| H1229..... | 72 |
| H1230C..... | 72 |
| H1246..... | 64 |
| H1604..... | 70 |
| H2997BH..... | 133 |
| H3900GY..... | 32, 142 |
| H3902GY..... | 32, 142 |
| H3903GY..... | 32, 142 |
| H3905GY..... | 32, 142 |
| H3909GY..... | 32, 142 |
| H3910GY..... | 32, 142 |
| H4258..... | 63 |
| H5633..... | 65 |
| H6610..... | 147 |
| H9085N..... | 77 |
| H9085NBK..... | 77 |
| H110204..... | 123 |
| HB1..... | 32 |
| HBH860..... | 78 |
| HBT1914..... | 47 |
| HDS492..... | 79 |
| GRSS1..... | 92, 97 |
| GRSS2..... | 92, 97 |
| GRSS3..... | 92, 97 |
| HVN142..... | 79 |
| JC1032A..... | 60 |
| JC1064A..... | 60 |
| JC1128A..... | 60 |
| JJ1202..... | 63 |
| JJ1205..... | 63 |
| JJ1206..... | 63 |
| KK3..... | 153 |
| KK3CLP..... | 153 |
| KK3SRB..... | 153 |
| M2474..... | 103 |
| M2475..... | 103 |
| M2485..... | 103 |
| M2489..... | 103 |
| M2493..... | 103 |
| MEDIUM..... | 37 |
| MEDRARE..... | 37 |
| MEDWELL..... | 37 |
| MG1120BK..... | 5 |
| MG1120W..... | 5 |
| MG1165BK..... | 5 |
| MG1165W..... | 5 |
| MG1265BK..... | 5 |
| MG1265W..... | 5 |
| MG1365BK..... | 5 |
| MG1365W..... | 5 |
| MG1465BK..... | 5 |
| MG1465W..... | 5 |
| MG2420BK..... | 5 |
| MG2420W..... | 5 |
| MG11100BK..... | 5 |
| MG11100R..... | 5 |
| MG11100W..... | 5 |
| MG12100BK..... | 5 |
| MG12100R..... | 5 |
| MG12100W..... | 5 |
| MG13100BK..... | 5 |
| MG13100R..... | 5 |
| MG13100W..... | 5 |
| MW40..... | 132 |

| | |
|------------------|--------|
| N20C..... | 122 |
| N32A..... | 61 |
| N32LPA..... | 61 |
| N175..... | 42 |
| N175F..... | 42 |
| N481..... | 157 |
| N481BK..... | 157 |
| P555..... | 84 |
| P57S..... | 84 |
| P260..... | 84 |
| P260SL..... | 84 |
| P800..... | 84 |
| P800BK..... | 84 |
| PB5119..... | 72 |
| PC1..... | 31 |
| PCD1..... | 28, 30 |
| PCD2..... | 30 |
| PD8..... | 149 |
| PKR-1..... | 146 |
| PM1918..... | 82 |
| PP321..... | 49 |
| PR8..... | 149 |
| PS13..... | 140 |
| RACA300..... | 24 |
| RARE..... | 37 |
| RB2..... | 153 |
| RBAM300..... | 24 |
| RBK300..... | 24 |
| RCBCRATE1..... | 15 |
| RCBCRATE1SM..... | 15 |
| RCBCRATE2..... | 15 |
| RFTT3BAML..... | 27 |
| RFTT3BAMM..... | 27 |
| RFTT3BAMS..... | 27 |
| RFTT3BKL..... | 27 |
| RFTT3BKM..... | 27 |
| RFTT3BKS..... | 27 |
| RGC34..... | 48 |
| RIB76..... | 72 |
| RP68..... | 49 |
| RR3..... | 25 |
| RS3..... | 24 |
| RS1432..... | 73 |
| RS2132..... | 73 |
| RSB33..... | 48, 77 |
| S209..... | 63 |
| SAIGNANT..... | 37 |
| SB53A..... | 124 |
| SB63A..... | 124 |
| SF10..... | 132 |
| SF12..... | 132 |
| SF14..... | 132 |
| SF16..... | 132 |
| SF18..... | 132 |
| SF20..... | 132 |
| SF24..... | 132 |
| SG200..... | 147 |
| SG203BH..... | 147 |
| SG204BH..... | 147 |
| SG205BH..... | 147 |
| SP10..... | 132 |
| SP12..... | 132 |
| SP14..... | 132 |
| SP16..... | 132 |
| SQH6..... | 125 |

| | |
|---------------|-----|
| SQH8..... | 125 |
| ST363B-1..... | 72 |
| T4..... | 125 |
| T6..... | 125 |
| T8..... | 125 |
| TB60..... | 148 |
| TB1164..... | 148 |
| TB24039..... | 148 |
| TRS12..... | 91 |
| TRS23..... | 91 |
| TRS34..... | 91 |
| TRSP12..... | 91 |
| TRSP23..... | 91 |
| TRSP34..... | 91 |
| TRW12..... | 91 |
| TRW23..... | 91 |
| TRW34..... | 91 |
| V119..... | 64 |
| V119GN..... | 64 |
| W12..... | 131 |
| W14..... | 131 |
| W16..... | 131 |
| W18..... | 131 |
| WBAM3..... | 24 |
| WBK3..... | 24 |
| WELLDONE..... | 37 |
| WF200BK..... | 71 |
| WP5BKKEU..... | 72 |
| WPA5SS..... | 72 |
| WSC12..... | 146 |



Scan to access our ftp site
links.tablecraft.com_ftpeu
 for additional marketing
 materials and product
 images available 24/7.

STAY CONNECTED

For more up-to-date content from us
 why not follow our blog:
WWW.TABLECRAFT.COM/BLOG

Or follow us on social media:

-  [/tablecraftEU](https://www.facebook.com/tablecraftEU)
-  [@tablecraftEU](https://twitter.com/tablecraftEU)
-  [@tablecraftEU](https://www.instagram.com/tablecraftEU)
-  [/tablecraft-products-company](https://www.linkedin.com/company/tablecraft-products-company)

REFERENCE AT THE READY

Be sure to check out TableCraft's global website! Our site is full of features and customised solutions to meet your foodservice and hospitality needs. Simply enter eu.tablecraft.com into your web browser or scan the QR code below to head directly to our homepage.



Scan to explore
eu.tablecraft.com

Easily translate our site into dozens of other languages

Find our US sites and Table Talk Blog here

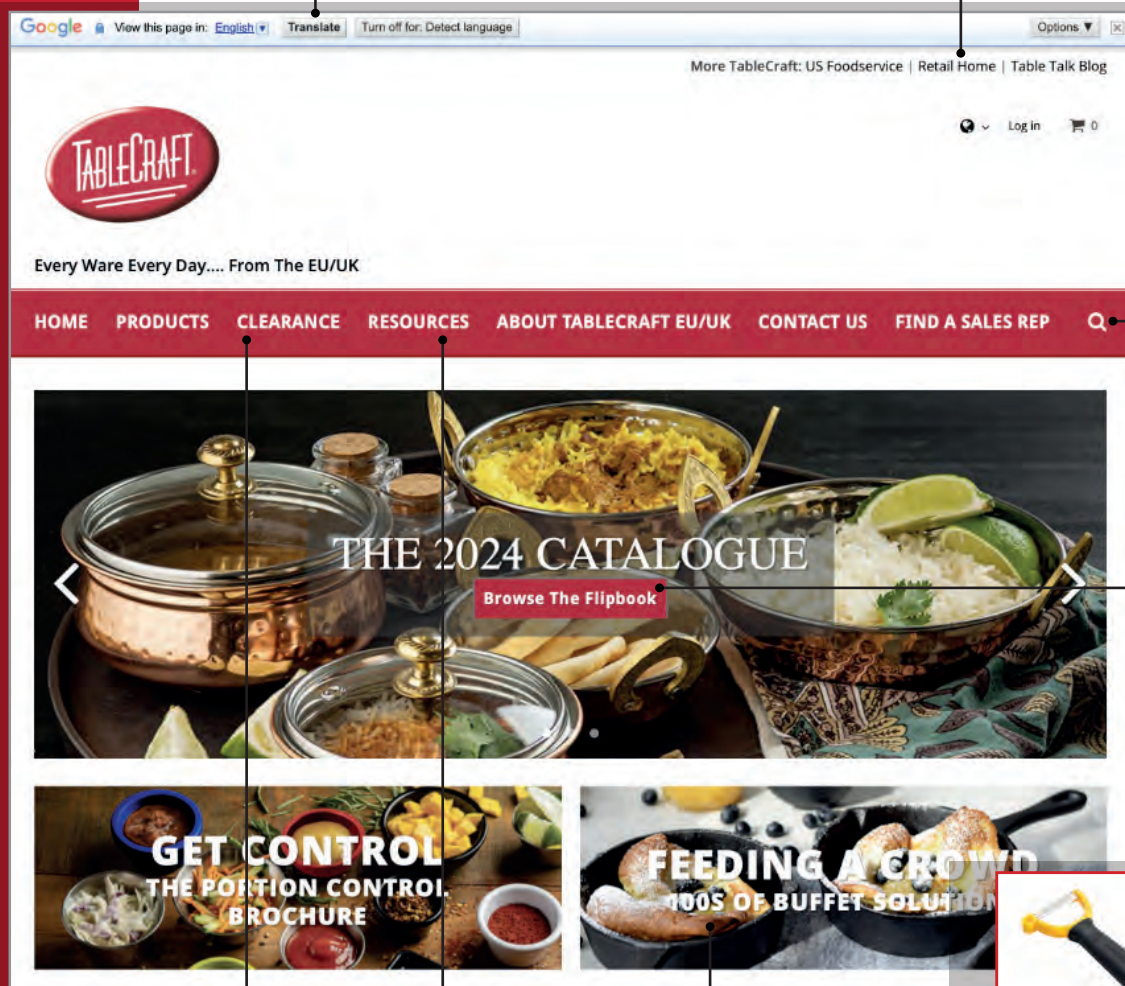

Easily search for products

View our new digital catalogue here

Find great deals in our new Clearance section

Review Brochures, Sell Sheets & Catalogues all in one place

Check out our featured products and collections

Product listings include a Real Time Inventory tracker



Providing Solutions for over 75 Years
Every Ware. Every Day.



Scan to explore
eu.tablecraft.com

European Headquarters
27 Causeway Road, Corby
Northants. NN17 4DU

Customer Service: 01536 400091
salesuk@tablecraft.com

eu.tablecraft.com



©2024 TPC, Inc.

