





L E B U F F E T E V E N T O

BUFFET

Du petit-déjeuner au dîner, des buffets sucrés aux buffets salés, la collection EVENTO répond à tous les scénarios de réception tout en assurant une hygiène parfaite pour satisfaire au mieux les nouvelles exigences de vos clients.

From breakfast to dinner, from sweet buffets to savoury spreads, the EVENTO collection works for all your reception needs while ensuring perfect hygiene to best meet the new requirements of your customers.



EVENTO

Buffet



Le buffet EVENTO au design homogène, harmonieux, fonctionnel et modulable, dispose de nombreux produits qui éviteront d'exposer leur contenu à l'air libre tout en conservant les aliments au frais comme au chaud et qui peuvent être utilisés pour la majorité en portion individuelle ou à usage unique. La richesse de ses combinaisons et la diversité de ses matériaux (acier, porcelaine, verre, grès, mélamine pierre et bois etc...) s'adaptent à votre style et à la dimension de votre établissement. La collection EVENTO valorise avec une touche de chic la mise en scène de vos buffets, selon le moment de la journée, de la saison...

The EVENTO buffet with a unified, harmonious, practical and modular design has many products that will avoid exposing their contents to the open air while keeping the food cool as well as warm and which can be used for the most part in individual portions or single use. With a host of combinations and a range of materials to choose from (steel, porcelain, glass, stoneware, melamine, stone and wood...), you can find what works for your style and the size of your space. The EVENTO collection adds a chic touch to your buffet presentations to reflect the time of day or the season.



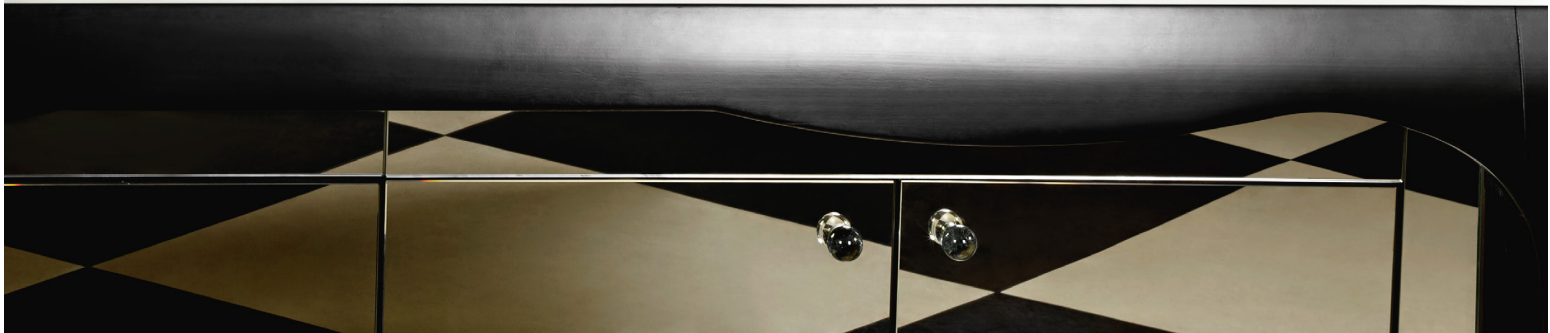









Termas Chillan, Chili,
Capacité 109 chambres
Capacity 109 rooms





CHAFING DISHES*

Couvercle en verre transparent pour percevoir le contenu et rendre le buffet plus gourmand

Clear glass cover allows contents to be viewed instantly and makes the buffet more enticing

Charnière avec vérin et amortisseur pour un réel confort d'utilisation et une fermeture en douceur

The hydraulic buffering hinge offers user comfort and convenience with its soft closure mechanism



Encoches pour les couverts de service

The notch for the serving cutlery

Compatible plaque induction, avec résistance électrique ou porte-brûleur avec gel combustible

Compatible with induction, electrical and/or «sterno» fuel heating system

Acier inoxydable, couvercle avec gouttière, verre trempé, système de récupération d'eau de condensation

Stainless steel, lid with groove, condensation water collection system in the porcelain insert

35,5 CM - 14 IN

41 CM - 16 IN^{1/8}



Ø 35,5 CM X P 41 CM X H 15 CM
Ø 14 IN X D 16 IN^{1/8} X H 5 IN^{7/8}

2 FINITIONS
FINISHES

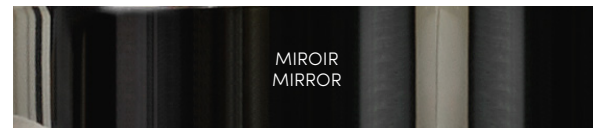

MIROIR
MIRROR



BROSSÉ
BRUSHED

*Certaines pièces sont disponibles en pièces détachées
Some items are available individually



Le Chafing dish, par son design contemporain alliant acier, porcelaine et verre offre à votre buffet une présentation soignée et raffinée.
The Chafing dish, with its contemporary design that combines steel, porcelain and glass, brings a smart and sophisticated touch to your buffet display.

CHAFING DISHES*

FINITION MIROIR
MIRROR FINISH



FINITION BROSSÉE
BRUSHED FINISH



CHAFING DISH 236195
SANS BAC Ø 35,5 CM - P 41 CM - H 15 CM
ACIER INOXYDABLE Ø 14 IN - D 16 IN^{1/8} - H 5 IN^{7/8}
+ COUVERCLE
AVEC GOUTTIÈRE
VERRE TREMPÉ
CHAFING DISH
WITHOUT INSERT
STAINLESS STEEL
+ LID WITH GROOVE,
TEMPERED GLASS

236194
Ø 35,5 CM - P 41 CM - H 15 CM
Ø 14 IN - D 16 IN^{1/8} - H 5 IN^{7/8}



SUPPORT CHAFING 203005
ACIER INOXYDABLE Ø 35 CM - P 40 CM - H 12,5 CM
POUR RÉSISTANCE ÉLECTRIQUE Ø 13 IN^{3/4} - D 15 IN^{3/4} - H 4 IN^{15/16}
OU PORTE-BRÛLEUR
AVEC GEL COMBUSTIBLE
CHAFING STAND STAINLESS STEEL,
FOR ELECTRICAL AND/OR
STERNO HEATING PURPOSES

202859
Ø 35 CM - P 40 CM - H 12,5 CM
Ø 13 IN^{3/4} - D 15 IN^{3/4} - H 4 IN^{15/16}

*Certaines pièces sont disponibles en pièces détachées
Some items are available individually

ACIER
STAINLESS STEEL

PORCELAINE
PORCELAIN



COUVERCLE 203470
AVEC GOUTTIÈRE ACIER, Ø 33 CM - 13 IN
VERRE TREMPÉ
LID WITH STAINLESS STEEL
GUTTER,
TEMPERED GLASS

BAC POUR 216142
CHAFING DISH Ø 35,6 X H 7 CM
CHAFING INSERT CONTENANCE 3L
Ø 14 X 2 IN^{3/4}
CAPACITY 100 OZ

215721
Ø 35,6 X H 7 CM
CONTENANCE 3L
Ø 14 X 2 IN^{3/4}
CAPACITY 100 OZ



RÉSISTANCE 202860
AVEC RÉGULATEUR 220 /240 V /200 W
DE TEMPÉRATURE 20 X 20 CM - 7 IN^{7/8} X 7 IN^{7/8}
HEATING ELEMENT -
HEAT ADJUSTABLE

203468
110 /120 V
20 X 20 CM - 7 IN^{7/8} X 7 IN^{7/8}

1/2 BAC PORCELAINE 202635*
POUR L 29 X L 15 X H 4,5 CM
CHAFING DISH CONTENANCE 1L
1/2 CHAFING 11 IN^{7/16} X 5 IN^{7/8} X 1 IN^{3/4}
PORCELAIN INSERT CAPACITY 33 OZ^{13/16}



PORTE-BRÛLEUR 202861
POUR GEL Ø 9 CM - H 6 CM
COMBUSTIBLE ACIER Ø 3 IN^{9/16} X 2 IN^{3/8}
BURNER HOLDER STEEL

1/2 BAC PORCELAINE 236684*
POUR CHAFING DISH L 29,3 CM X H 4,6 CM
AVEC SÉPARATEUR L 11 IN^{9/16} X H 1 IN^{13/16}
1/2 CHAFING
PORCELAIN INSERT

*À commander obligatoirement avec le bac pour chafing dish (216142 ou 215721)
Must be ordered with the chafing insert (216142 or 215721)

MODULES FROIDS* REFRIGERATED UNITS



3 FINITIONS
FINISHES

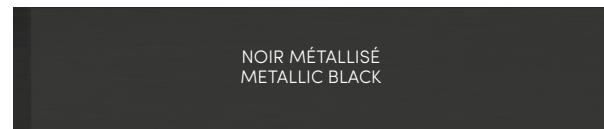
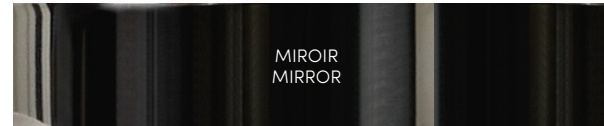

FINITION MIROIR
MIRROR FINISH



FINITION BROSSÉE
BRUSHED FINISH



FINITION NOIR MÉTALLISÉ
METALLIC BLACK FINISH



MODULE ACIER **202864**
+ BAC PLASTIQUE⁽¹⁾
REFRIGERATED SET
+ PLASTIC TRAY

GN1/1
L 56,5 CM - P 36 CM - H 9,5 CM
22 IN^{1/4} - D 14 IN^{3/16} X 3 IN^{3/4}

235356
GN1/2
29,5 X 35,6 CM
11 IN^{5/8} X 14 IN

202865
GN1/1
L 56,5 CM - P 36 CM - H 9,5 CM
22 IN^{1/4} - D 14 IN^{3/16} X 3 IN^{3/4}

235361
GN1/2
29,5 X 35,6 CM
11 IN^{5/8} X 14 IN

202869
GN1/1
L 56,5 CM - P 36 CM - H 9,5 CM
22 IN^{1/4} - D 14 IN^{3/16} X 3 IN^{3/4}

235362
GN1/2
29,5 X 35,6 CM
11 IN^{5/8} X 14 IN



COUVERCLE **202871**
MODULE RÉFRIGÉRÉ
POIGNÉE INOXYDABLE
LID FOR REFRIGERATED SET/
STAINLESS STEEL HANDLE

56 X 35 X 19 CM
22 IN^{1/16} X 13 IN^{3/4} X 7 IN^{1/2}

PLAQUE EUTECTIQUE **208357**
NOIRE POUR
MODULE FROID
BLACK COOLING
EUTECTIQUE BLOCK
FOR UNIT

GN1/1
48 X 28 X 3 CM
18 IN^{7/8} X 11 IN X 1 IN^{3/16}



239786
GN1/2
18 X 25 CM
7 IN^{18/16} X 9 IN^{13/16}

*Certaines pièces sont disponibles en pièces détachées
Some items are available individually

(1) Garantie lave-vaisselle
Dish washer safe



Le module réfrigéré reçoit une large gamme de contenants, plateaux et accessoires multi-matériaux au format GN en porcelaine, verre, acier, acrylique, mélamine pierre et mélamine bois. Ils permettent une infinité de combinaisons.
The refrigerated unit will hold a wide range of platters and multi-material accessories in Industry standard format in porcelain, glass, steel, acrylic stone and wood melamine allowing endless combinations.

PLATEAUX POUR MODULES FROIDS PLATTERS FOR REFRIGERATED UNITS

MÉLAMINE BOIS⁽¹⁾
WOOD MELAMINE TRAY



MÉLAMINE PIERRE⁽¹⁾
STONE MELAMINE TRAY



ACIER 18/10 NEWPORT
FINITION MIROIR
SERVING TRAY STAINLESS STEEL
18/10 MIRROR FINISHED



PLATEAUX
TRAYS

234546
GN1/1
53,5 X 32,5 CM
20 IN^{7/8} X 12 IN^{13/16}

234548
GN 2/3
35,4 X 32,5 CM
13 IN^{5/16} X 12 IN^{13/16}

234551
GN 1/2
26,4 X 32,5 CM
10 IN^{3/8} X 12 IN^{13/16}

234553
GN 1/3
17,5 X 32,5 CM
6 IN^{7/8} X 12 IN^{13/16}

234547
GN1/1
53,5 X 32,5 CM
20 IN^{7/8} X 12 IN^{13/16}

234549
GN 2/3
35,4 X 32,5 CM
13 IN^{5/16} X 12 IN^{13/16}

234552
GN 1/2
26,4 X 32,5 CM
10 IN^{3/8} X 12 IN^{13/16}

234554
GN 1/3
17,5 X 32,5 CM
6 IN^{7/8} X 12 IN^{13/16}

185021
GN1/1
53,5 X 32,5 CM
20 IN^{7/8} X 12 IN^{13/16}

185019
GN 1/2
26,4 X 32,5 CM
10 IN^{3/8} X 12 IN^{13/16}



PLATEAUX
3 TROUS
3 HOLES TRAYS

234557
GN 1/6
8,7 X 32,5 CM
3 IN^{7/16} X 12 IN^{13/16}



234558
GN 1/6
8,7 X 32,5 CM
3 IN^{7/16} X 12 IN^{13/16}

(1) Compatible lave-vaisselle, NON compatible micro-ondes
Dish washer safe, DONT USE with micro-wave

VERRE ÉPAISSEUR 0,6 CM
TEMPERED GLASS THICKNESS IN^{1/4}



230752
GN 1/1
53,5 X 32,5 CM
20 IN^{7/8} X 12 IN^{13/16}

230753
GN 2/3
35,4 X 32,5 CM
13 IN^{15/16} X 12 IN^{13/16}

ACRYLIQUE ÉPAISSEUR 1 CM
ACRYLIC THICKNESS IN^{3/8}

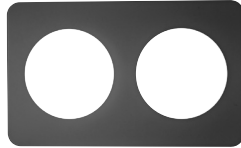

230756
GN 1/1 - 2 TROUS
2 HOLES
53,5 X 32,5 CM - 20 IN^{7/8} X 12 IN^{13/16}

230757
GN 1/3 - 2 TROUS - BOLS 14 CM
2 HOLES - BOWLS 5,5 IN
17,5 X 32,5 CM - 6 IN^{7/8} X 12 IN^{13/16}

GRÈS CARBONE (2)
GREY STONEWARE



234550
GN 2/3
35,4 X 32,5 CM
13 IN^{15/16} X 12 IN^{13/16}

234555
GN 1/3
17,5 X 32,5 CM
6 IN^{7/8} X 12 IN^{13/16}

PORCELAINE (2)
WHITE ENAMELLED PORCELAIN



202628
GN 2/3
35,4 X 32,5 CM
13 IN^{15/16} X 12 IN^{13/16}

202629
GN 1/2
26,4 X 32,5 CM
10 IN^{3/8} X 12 IN^{13/16}

202627
GN 1/3
17,5 X 32,5 CM
6 IN^{7/8} X 12 IN^{13/16}

PLATEAU
À REBORDS
EDGE TRAY

234556
GN 1/3
17,5 X 32,5 CM
6 IN^{7/8} X 12 IN^{13/16}



PLAT CREUX
PORCELAINE
PORCELAIN
DEEP DISH

202630
GN 1/3
17,5 X 32,5 CM
6 IN^{7/8} X 12 IN^{13/16}



URNES À JUS DE FRUITS* FRUIT JUICE URNS

Urne à jus de fruit dotée d'un tube central en acier pour glace pilée : parfait maintien de la fraîcheur
Fruit juice urn with central steel tube to hold crushed ice, for perfect freshness



FINITION MIROIR
MIRROR FINISH

FINITION BROSSÉE
BRUSHED FINISH

URNE À JUS DE FRUITS 4L **231303**
ACIER 18-10 L 20 CM X P 32 CM X H 45 CM
W 7 IN^{7/8} X D 12 IN^{5/8} X H 17 IN^{11/16}
JUICE DISPENSER 135 OZ
STAINLESS STEEL

231304
L 20 CM X P 32 CM X H 45 CM
W 7 IN^{7/8} X D 12 IN^{5/8} X H 17 IN^{11/16}

CRISTALLIN SOUFLÉ BOUCHE
HAND BLOWN CRYSTALLINE



CARAFE À JUS DE FRUIT - 1,2 L **202639**
JUICE/BEVERAGE Ø 10,5 CM - H 27,5 CM
CARAFE - 40 OZ^{9/16} Ø 4 IN^{1/8} X H 10 IN^{13/16}

PORCELAINE
PORCELAIN



CARAFE À LAIT - 1,2 L **202636**
MILK JUG Ø 10,5 CM - H 27,5 CM
- 40 OZ^{9/16} Ø 4 IN^{1/8} X H 10 IN^{13/16}

Bouchon verseur, pour une meilleure hygiène
Hygienic pouring stopper



BOUCHON DE CARAFE SILICONE **202855**
STOPPER FOR CARAFE SILICONE Ø 6,5 CM - H 4,2 CM
Ø 2 IN^{9/16} X H 1 IN^{5/8}

*Certaines pièces sont disponibles en pièces détachées
Some items are available individually

DISTRIBUTEURS À CÉRÉALES* CEREAL DISPENSERS

Distributeur à céréales 1 ou 3 tubes avec ailettes souples pour ne pas casser les céréales
Cereal dispenser 1 or 3 tubs with flexible spout so as not to break the cereals



X3

DISTRIBUTEUR À CÉRÉALES 231300
CEREAL DISPENSER L 50 CM X P 20 CM X H 55,5 CM
W 19 IN^{11/16} X D 7 IN^{7/8} X H 21 IN^{7/8}
CAPACITÉ : 3 X 3,5 L
CAPACITY : 3 X 1 GAL



X1

231299
L 19 CM X P 20 CM X H 55,5 CM
W 7 IN^{1/2} X D 7 IN^{7/8} X H 21 IN^{7/8}
CAPACITÉ : 3,5 L
CAPACITY : 1 GAL



RAFRAICHISSEUR 237501
DROIT Ø 13,9 X H 19,8 CM
DOUBLE PAROI Ø 5 IN^{7/8} X H 7 IN^{13/16}
CURVED
DOUBLE WALL
WINE COOLER



BOL 154245
PORCELAINE **MODULO BLANC**
PORCELAIN BOWL WHITE MODULO
14 CM - 5 IN^{1/2}

202626
EMPILABLE
STACKABLE



ETIQUETTE PORCELAINE 202632
AVEC AIMANT 10 X 5 CM
+ SUPPORT ACIER 3 IN^{15/16} X 1 IN^{15/16}
PORCELAIN STICK +
STAINLESS STEEL STAND
WITH MAGNET

SUPPORTS À FIL TRAYS



Panière reversible pour une présentation droite ou inclinée
Reversible basket for a level or tilted display



Des supports en acier noir mat de hauteurs différentes pour rythmer les présentations.
Black mat finish supports of differing heights can be used to create a varied presentation.

SUPPORTS À FIL RECTANGULAIRES RECTANGULAR TRAYS



1

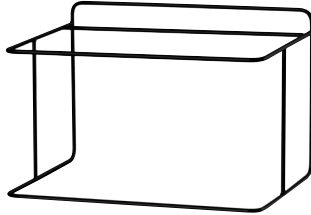

2

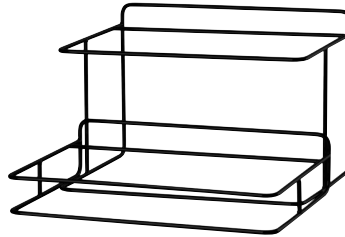

1 + 2



PANIÈRE 230749
RECTANGULAIRE GN 1/1
 RECTANGULAR 54 X 34 X H 7 CM
 BREAD BASKET 21 IN^{1/4} X 13 IN^{3/8} X 2 IN^{3/4}

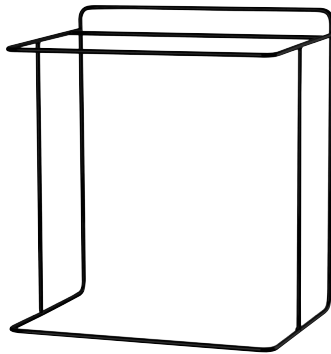

3

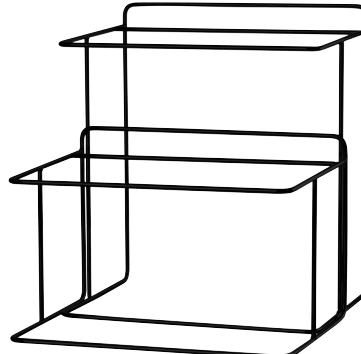

2 + 3

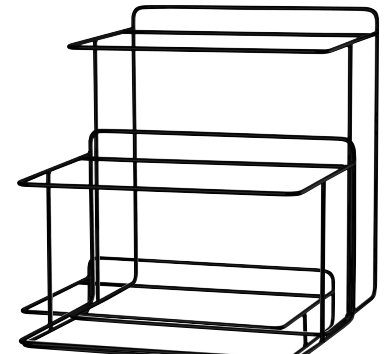

1 + 2 + 3

SUPPORT 230741
RECTANGULAIRE NIVEAU 1
 RECTANGULAR TRAY LEVEL 1
 L 44 X P 30,8 X H 10,8 CM
 W 17 IN^{5/16} X D 12 IN^{1/8} X H 4 IN^{1/4}

230742
NIVEAU 2
 LEVEL 2
 L 42 X P 30,8 X H 29,8 CM
 W 16 IN^{5/16} X D 12 IN^{1/8} X H 11 IN^{3/4}

230743
NIVEAU 3
 LEVEL 3
 L 40 X P 30,8 X H 48,8 CM
 W 15 IN^{3/4} X D 12 IN^{1/8} X H 19 IN^{3/16}

230741 + 230742
NIVEAU 1 + 2
 LEVEL 1+2
 L 44 X P 50 X H 29,8 CM
 W 17 IN^{5/16} X D 19 IN^{11/16} X H 11 IN^{3/4}

230742 + 230743
NIVEAU 2 + 3
 LEVEL 2+3
 L 42 X P 50 X H 48,8 CM
 W 16 IN^{5/16} X D 19 IN^{11/16} X H 19 IN^{3/16}

230741 + 230742 + 230743
NIVEAU 1 + 2 + 3
 LEVEL 1+2+3
 L 44 X P 68,2 X H 48,8 CM
 W 17 IN^{5/16} X D 26 IN^{7/8} X H 19 IN^{3/16}

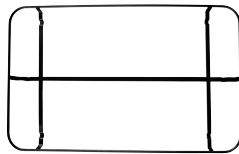

CADRE ACIER 230744
POUR SUPPORT L 55,5 X P 35 X H 4,5 CM
RECTANGULAIRE⁽²⁾ W 21 IN^{7/8} X D 13 IN^{3/4} X H 1 IN^{3/4}
STEEL FRAME FOR STAND

MÉLAMINE BOIS⁽²⁾
WOOD MELAMINE TRAY



PLATEAUX 234546
TRAYS
GN1/1
53,5 X 32,5 CM
20 IN^{7/8} X 12 IN^{13/16}

MÉLAMINE PIERRE⁽²⁾
STONE MELAMINE TRAY



234547
GN1/1
53,5 X 32,5 CM
20 IN^{7/8} X 12 IN^{13/16}

ACIER 18/10 NEWPORT
FINITION MIROIR
SERVING TRAY STAINLESS STEEL
18/10 MIRROR FINISHED



185021
GN1/1
53,5 X 32,5 CM
20 IN^{7/8} X 12 IN^{13/16}

VERRE ÉPAISSEUR 0,6 CM
TEMPERED GLASS THICKNESS IN^{1/4}



230752
GN1/1
53,5 X 32,5 CM
20 IN^{7/8} X 12 IN^{13/16}

SUPPORTS À FIL RONDS ROUND TRAYS

GRÈS CARBONÉ⁽¹⁾
GREY STONEWARE

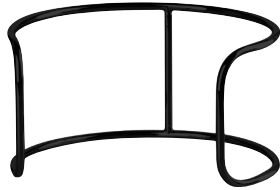

SUPPORT ROND BAS
ROUND STAND LOW LEVEL
Ø 25 CM X H 13 CM
Ø 9 IN^{13/16} X H 5 IN^{1/8}

230746 HAUT
HIGH LEVEL
Ø 25 CM X H 26 CM
Ø 9 IN^{13/16} X H 10 IN^{1/4}



SALADIER BAS
SALAD BOWL
Ø 25,4 X 7 CM - 2,4 L
Ø 10 IN X 2 IN^{3/4} - 80 OZ^{1/8}



PANIÈRES INDIVIDUELLE
BREAD BASKETS INDIVIDUAL
Ø 18 CM X 6 CM
Ø 7 IN^{1/16} X 2 IN^{3/8}

230748 RONDE
ROUND
Ø 32 CM X H 8 CM
Ø 12 IN^{5/8} X H 3 IN^{1/8}

MÉLAMINE BOIS⁽²⁾
WOOD MELAMINE TRAY



PLATEAUX ROUNDS
ROUND TRAYS
Ø 32 CM
12 IN^{5/8}

MÉLAMINE PIERRE⁽²⁾
STONE MELAMINE TRAY



234562
Ø 32 CM
12 IN^{5/8}

PORCELAINE MODULO
MODULO PORCELAIN
PIE/PIZZA PLATE, FLAT



136524
Ø 32 CM
12 IN^{5/8}

(1) Compatible lave-vaisselle, Compatible micro-ondes
Dish washer safe, Micro-wave safe

(2) Compatible lave-vaisselle, NON compatible micro-ondes
Dish washer safe, DONT USE with micro-wave safe



ACCESSOIRES ACCESSORIES

PIERRE DE LUNE
MOONSTONE
Porcelaine - Porcelain



SALADIER 239325
BOWL
28 CM - 11 IN
4L - 135 OZ^{1/4}

DUNE
BEIGE DUNE
Grès - Stoneware



235223
28 CM - 11 IN
4L - 135 OZ^{1/4}

BLEU DE ROCHE
BLUE STONE
Grès - Stoneware



235222
28 CM - 11 IN
4L - 135 OZ^{1/4}

ONYX
BLACK ONYX
Grès - Stoneware



240499
28 CM - 11 IN
4L - 135 OZ^{1/4}

ARGILE VERTE
GREEN CLAY
Grès - Stoneware



-NEW- PLANCHE 242054
RECTANGULAIRE 35 x 21 CM
RECTANGULAR BOARD
13 IN^{3/4} x 8 IN^{1/4}



242056
35 x 21 CM
13 IN^{3/4} x 8 IN^{1/4}



242052
35 x 21 CM
13 IN^{3/4} x 8 IN^{1/4}



237206
25 X 13,5 CM
9 IN^{13/16} X 5 IN^{5/16}



234949
25 X 13,5 CM
9 IN^{13/16} X 5 IN^{5/16}

234948
25 X 13,5 CM
9 IN^{13/16} X 5 IN^{5/16}

234950
25 X 13,5 CM
9 IN^{13/16} X 5 IN^{5/16}

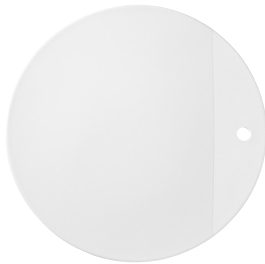

-NEW- PLANCHE 242055
RONDE 29 CM - 11 IN^{7/16}
ROUND BOARD



242057
29 CM - 11 IN^{7/16}

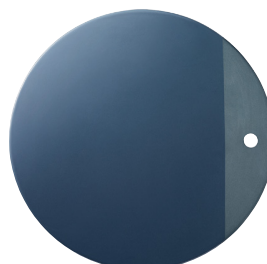

242053
29 CM - 11 IN^{7/16}



-NEW- PLAT 241835
GRAND MODÈLE 31,8 x 25 x 7,4 CM
LARGE DISH
12 IN^{1/2} x 9 IN^{13/16} x 2 IN^{15/16}



237595
31,8 x 25 x 7,4 CM
12 IN^{1/2} x 9 IN^{13/16} x 2 IN^{15/16}

PLAT 241834
MOYEN MODÈLE 22,8 x 16,2 x 5,4 CM
MEDIUM DISH
9 IN x 6 IN^{3/8} x 2 IN^{1/8}

237594
22,8 x 16,2 x 5,4 CM
9 IN x 6 IN^{3/8} x 2 IN^{1/8}

PLAT 241833
PETIT MODÈLE 15,5 x 10,7 x 4,4 CM
SMALL DISH
6 IN^{7/8} x 4 IN^{3/16} x 1 IN^{3/4}

237593
15,5 x 10,7 x 4,4 CM
6 IN^{7/8} x 4 IN^{3/16} x 1 IN^{3/4}



PLANCHE À PAIN 202854
BAMBOU AVEC GN 1/1
RÉCUPÉRATEUR DE MIETTES 53 X 32,5 CM
 BAMBOO BREAD BOARD 20 IN^{7/8} X 12 IN^{13/16}
 WITH CRUMB TRAY



COUTEAU À PAIN 229516
L'ECONOME BY STARCK® 24 CM - 9 IN^{7/16}
POSITIONNABLE
DANS LA PLANCHE
 L'ECONOME BY STARCK®
 BREAD KNIFE FITS IN A SLOT IN
 THE BREAD BOARD



COUTEAU À PAIN 217814
L'ECONOME ECO NATURE® 18 CM - 7 IN^{1/16}
POSITIONNABLE
DANS LA PLANCHE
 L'ECONOME ECO NATURE®
 BREAD KNIFE FITS IN A SLOT IN
 THE BREAD BOARD



PRÉSENTOIR 209381
À GÂTEAUX ROND Ø 25 CM - 9 IN^{13/16}
 ROUND APP/PIZZA/
 PRESENTATION STAND 209382
 Ø 32 CM - 12 IN^{5/6}



CLOCHE EVENTO VERRE 239769
 EVENTO DOME COVER Ø 16 CM - 6 IN^{5/16}

239770
 Ø 23 CM - 9 IN^{1/6}

239771
 Ø 28 CM - 11 IN

MÉLAMINE BOIS⁽²⁾
 WOOD MELAMINE TRAY



(1) PLANCHA 234559
AVEC MANCHE 17,5 X 45 CM
 BOARD 6 IN^{7/8} X 17 IN^{11/16}

MÉLAMINE PIERRE⁽²⁾
 STONE MELAMINE TRAY



234560
 17,5 X 45 CM
 6 IN^{7/8} X 17 IN^{11/16}



SALADIER 202625
PORCELAINE 23 CM - 9 IN^{1/16}
EVENTO BLANC H : 9,6 CM - 3 IN^{3/4}
 WHITE EVENTO CONTENANCE : 2 L
 SALAD BOWL CAPACITY : 67 OZ^{5/8}



SALADIER 142722
PORCELAINE 28 CM - 11 IN
MODULO H : 12 CM - 4 IN^{3/4}
 DEEP SALAD CONTENANCE : 2,5 L
 BOWL, LARGE CAPACITY : 84 OZ^{9/16}



SUPPORT COUVERTS 202633
DE SERVICE 21 X 10 X 5 CM
PORCELAINE 8 IN^{1/4} X 3 IN^{15/16} X 1 IN^{15/16}
 SERVING CUTLERY DISPLAY
 WHITE PORCELAIN



ETIQUETTE 202632
PORCELAINE 10 X 5 CM
AVEC AIMANT 3 IN^{15/16} X 1 IN^{15/16}
+ SUPPORT ACIER
 PORCELAIN STICK + STAINLESS STEEL STAND WITH MAGNET



LOUCHE 153193
ASTRÉE MIROIR
 SOUP LADLE 29,7 CM - 11 IN^{11/16}



CISEAUX 204496
À GÂTEAUX 101494
 PASTRY 20 CM - 7 IN^{7/8}
 SCISSORS/TONG



PINCE À SERVIR 204499
SERVING TONG 184355
 29,5 CM - 11 IN^{5/8}



PINCE À PAIN 204498
BREAD TONG 101492
 23 CM - 9 IN^{1/16}

(1) **Planche de présentation uniquement, ne pas faire de découpe**
 Presentation board, dont cut on it

(2) **Compatible lave-vaisselle, NON compatible micro-ondes**
 Dish washer safe, DONT USE with micro-wave

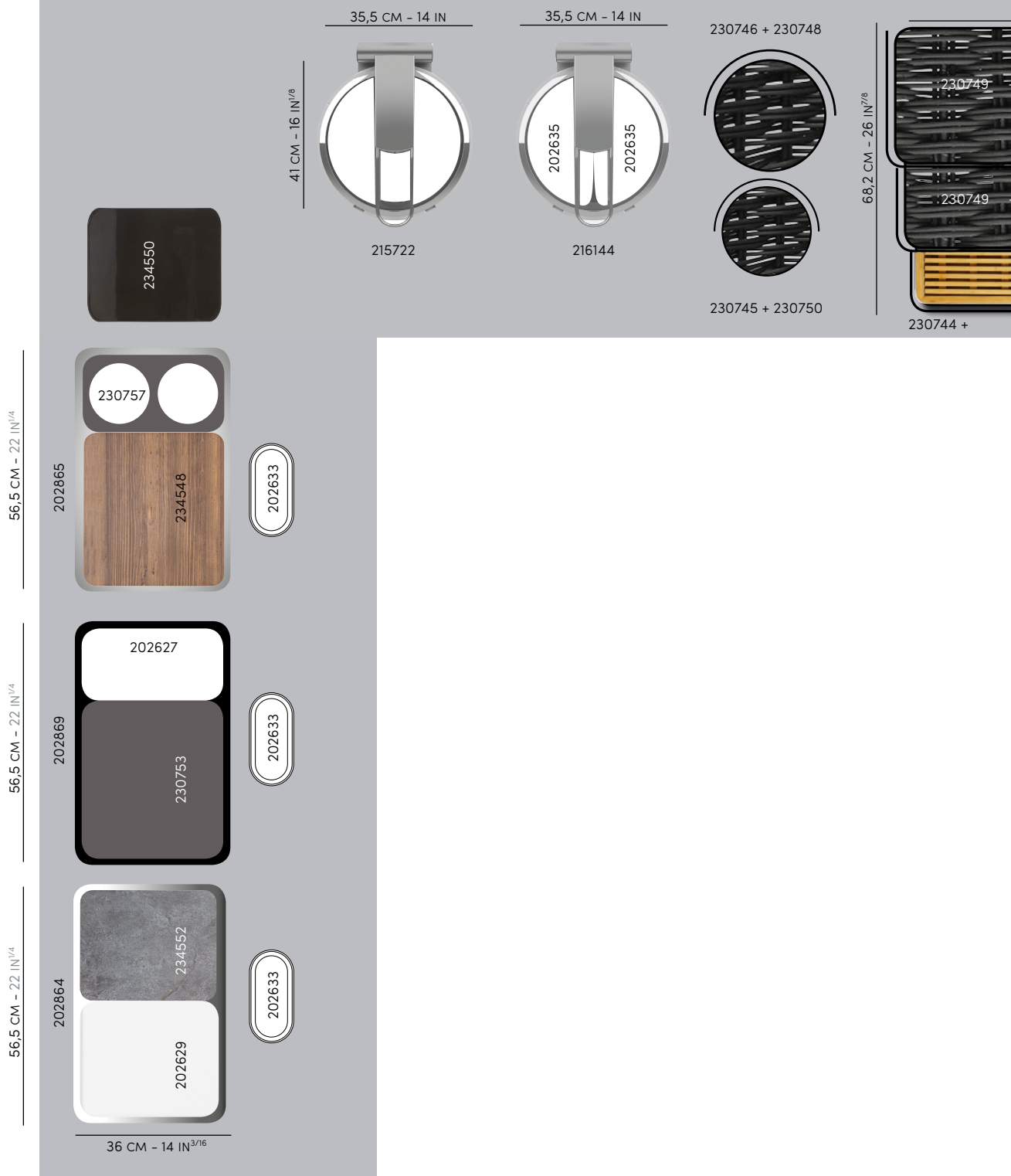



44 CM - 14 IN



230743

230742

202854 + 230741



242055

29 CM - 11 IN^{7/16}



239325

Ø 28 CM
Ø 11 IN



240499

234562
Ø 32 CM - 12 IN^{5/8}



239771
Ø 28 cm
Ø 11 in

Ø 32 cm
Ø 12 in^{5/8}

35,5 CM - 14 IN
209382

20 CM - 7 IN^{7/8}



237593

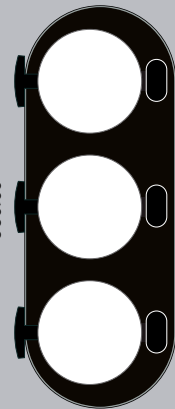

231300

50 CM - 19 IN^{11/16}

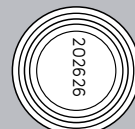

202626

32 CM - 12 IN^{5/8}

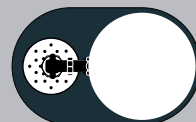

231303

20 CM
7 IN^{7/8}

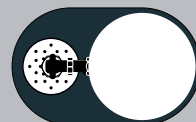

231303

20 CM
7 IN^{7/8}

CHAFING DISH

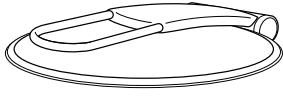

COUVERCLE AVEC GOUTTIÈRE 203470
ACIER ET VERRE TREMPÉ Ø 33 CM - Ø 13 IN
LID WITH STAINLESS STEEL
GUTTER,
TEMPERED GLASS

KIT SAV VÉRINS 217435
POUR CHAFING DISH
REPLACING KIT FOR
CHAFING DISH CYLINDER

JOINT POUR CHAFING DISH 230050
SEAL FOR CHAFING DISH

MODULE FROID
REFRIGERATED UNIT



BAC PLASTIQUE 202866
PLASTIC TRAY 56 X 35,5 X 8 CM
22 IN^{1/16} X 14 IN X 3 IN^{1/8}

235357
29,5 X 35,6 CM
11 IN^{5/8} X 14 IN

URNE À JUS DE FRUITS
FRUIT JUICE URN

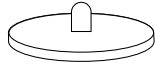

COUVERCLE URNE 202881
ACIER 18-10 **FINITION MIROIR**
LID FOR STAINLESS MIRROR FINISH
DISPENSER 18-10 Ø 17,9 CM
7 IN^{1/16}

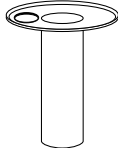

TUBE ACIER POUR 202884
GLACE Ø 9 CM - 3 IN^{9/16}
ICE TUBE
STAINLESS STEEL

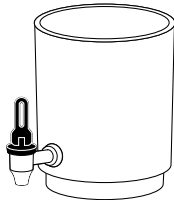

FÛT CYLINDRIQUE 202883
URNE 5 L - 169 OZ^{1/16}
CONTAINER FOR BRUSHED FINISH
DISPENSER Ø 17,7 CM X H 25,5 CM
Ø 6 IN^{15/16} X H 10 IN^{1/16}

ROBINET ACIER 214724
ABS NOIR
STAINLESS STEEL
FAUCET BLACK

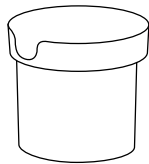

BASE ACIER 202890
18-10 URNE **FINITION MIROIR** **202889**
STAINLESS STEEL MIRROR FINISH BRUSHED FINISH
STAND FOR DISPENSER 18-10 Ø 17,6 CM - H 19 CM
Ø 17,6 CM - H 19 CM
6 IN^{15/16} X 7 IN^{1/2} 6 IN^{15/16} X 7 IN^{1/2}



GRILLE ACIER 045963
POUR GOUTTES - 18/10 Ø 9 CM
STAINLESS STEEL GRID Ø 3 IN^{9/16}
DROP COLLECTOR



SOCLE NOIR ACRYLIQUE URNE 230758
STAND FOR BLACK DISPENSER 20 X 32 CM
7 IN^{7/8} X 12 IN^{5/8}
ÉPAISSEUR : 2 CM
THICKNESS: 13/16 IN

DISTRIBUTEUR À CÉRÉALES
CEREAL DISPENSER



COUVERCLE 213078
DISTRIBUTEUR CEREALES Ø 12,5 CM
ACIER FINITION MIROIR - 18/10 Ø 4 IN^{15/16}
LID FOR CEREAL DISPENSER,
STAINLESS STEEL,
MIRROR FINISH

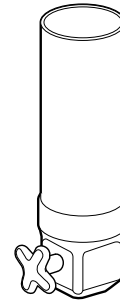

FUT CYLINDRIQUE 213076
AVEC AILETTE ET POIGNEE P 16,1 X H 42 CM
DISTRIBUTEUR CEREALES D 6 IN^{5/16} X H 16 IN^{9/16}
BARREL + HANDLE + ROLLING TAP
FOR CEREAL DISPENSER

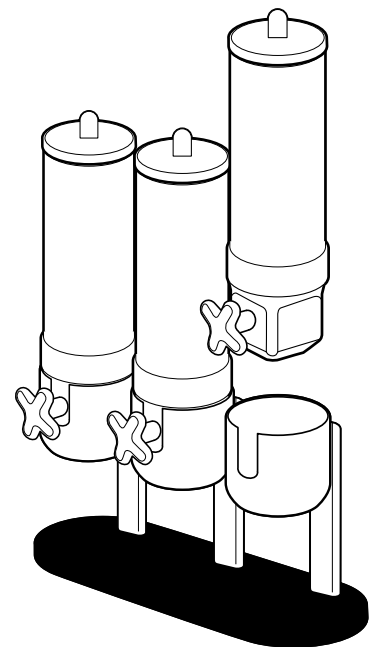

X3

X1

BASE + TUBE + SOCLE 231302
DISTRIBUTEUR À CEREALES L 50 X H 27,5 CM
STAINLESS STEEL STAND + TUB L 19 IN^{1/16} X H 29 IN^{3/4}
+ ACRYLIC STAND FOR CEREAL DISPENSER L 7 IN^{1/2} X H 29 IN^{3/4}