



“Emozionare oltre la funzione come solo l’atto creativo sa fare. Elevare il gusto e trasmettere la cultura del glassware e tableware professionale dando il massimo risalto al contenuto quanto al contenitore.”

Italesse dà vita ai propri prodotti, enfatizzando la forza del colore, il potere di linee e materiali innovativi, traducendo la funzionalità in dettagli di gusto. Cultura del design e know-how professionale ribadiscono la centralità di forma e funzione in prodotti contemporanei dall’appeal estetico e dal concept tecnico.

“To excite beyond function as only the creative act can. To elevate taste and convey the culture of professional glass and tableware, giving the same emphasis to the product’s contents as to the product itself.”

Italesse creates its products, emphasizing the strength of color, the power of innovative lines and materials, translating functionality into tasteful products. Design culture and professional know-how combine to reassert the centrality of form and function in contemporary products with aesthetic appeal and a highly technical concept.

Indice / Contents

06	Azienda / Company		
10	Portfolio		
16	Collezioni / Collections		
18	Wormwood Collection		
24	Etoilé Collection		
28	Etoilé Sparkle		
30	Etoilé Excellence® Collection		
32	Tiburón Collection		
36	Vertical Collection		
40	Bora Collection		
42	Easy Collection		
43	Dolcevita & Mastro		
44	Richard Juhlin Optimum		
46	Balloon Collection		
50	Riviera & Flute N°5		
52	Vertigo Tumbler		
56	Mares Collection		
60	Bolle Tumbler & Bolle Pitcher		
64	Dixie Tumbler		
66	Tonic Glass		
68	Sfera		
70	Go Go		
72	Premium Collection		
74	Beach Collection		
78	Air Beach Collection		
80	Bolle Beach Tumbler		
82	Fresnel Collection		
84	Tonic Beach		
85	Pachà Beach Light		
86	Vas & Organica		
88	Vinocchio		
90	Alavin		
		Collezioni / Collections	
		92	Plaza Bucket & Bowl
		94	Vela Bucket & Bowl
		98	Bolle Bucket & Bowl
		102	Solomon Bucket
		104	Pagoda Bucket & Gran Pagoda Bowl
		106	Tonic Ice Bucket & Bowl
		108	Easy Buckets & Bowls
		110	Bongo Bucket & Bowl
		112	Winston Bucket & Nevada Bowl
		114	Stripe
		116	Bolle Cake Stand
		118	Pebble
		121	Djambè Tapas
		122	Venti4
		124	Lollipop
		126	Ocean Stopper
		127	Fiesta Stopper & Fiesta Stopper Plus
		128	Designers & Opinion Leaders

Azienda / Company





Italesse, professionalità e design

Fondata nel 1979, Italesse individua da subito nel mercato del beverage una carenza di articoli professionali destinati a supportare le vendite di brand affermati che fossero nel contempo strumenti di comunicazione e di immagine. Da un'attenta ricerca tecnica nascono così le prime serie di calici, bicchieri, caraffe, decanter, glaccette, e con il tempo viene proposta una gamma completa ed esclusiva di accessori e bottiglie che impongono l'azienda all'attenzione dei più rinomati produttori di vini e champagne internazionali. Veuve Clicquot, Laurent Perrier, Mumm, Bacardi, Ferrari, Absolut, Heineken, per citarne alcuni, diventano i veri promotori di Italesse worldwide. In breve tempo il marchio vede crescere la propria diffusione grazie anche alla crescente richiesta da parte di hotel, resort e ristoranti che ne decretano il posizionamento nel mondo professionale. Obiettivi chiari, una strategia aziendale coraggiosa e in controtendenza con i tempi che, nella produzione di oggetti PREMIUM destinati ad una fascia di mercato medio/alta, radica un'identità aziendale forte, ulteriormente avvalorata da un concept produttivo fondante: fare del binomio forma/funzione la base di una costante ricerca tecnica e formale - materiali innovativi, applicazione del colore, tecnologie all'avanguardia. Dal 2007 l'azienda si rivolge anche al canale retail. Un'implementazione naturale seguita alla collaborazione con figure professionali specializzate ed a una brillante art direction. A completare il processo di espansione l'acquisizione nel 2012 della Velvet Glass International, azienda top level nella produzione di bottiglie di vetro extra white, che ha consentito ad Italesse di rafforzare l'offerta rivolta ai produttori di distillati, vini, olii ed aceti in cerca di packaging premium.

Italesse, Professionalism and Design

After its establishment in 1979, Italesse soon noticed a lack of products designed to support the image and sales of well-established brands in the complex beverage market. For this reason, after thorough research, the first series of stemware, glasses, carafes, decanters and glaccettes were produced, and after some time, a wide and exclusive range of other accessories and high-end bottles followed, which have placed Italesse in the highest ranks among international wine and champagne producers. Veuve Clicquot, Laurent Perrier, Mumm, Ferrari, Absolut, Heineken and many others have become the best promoters of the Italesse brand worldwide. In a short time, the brand grew thanks to its success in the hotel, resort and restaurant world thus entering the Horeca market in which Italesse immediately spotted great potential. A strong business identity based on clear objectives and a bold and countertrend business strategy for PREMIUM products, primarily destined for the medium to high-end market, is intertwined with a fundamental production concept - that of using form and function as the starting point for all research, be it into innovative materials, ergonomic shapes, the use of colors and ground-breaking technologies. Since 2007 Italesse is present in the retail sector, thanks to skilled professionals and an ingenious art direction. To complete its expansion process, the firm has acquired Velvet Glass International in 2012, a manufacturer of Luxury Design Glass Bottles. This acquisition has enabled Italesse to reinforce its offer, addressing the complex needs of producers of wines, liqueurs, oils and vinegars, that seek premium packaging for their products.

Portfolio

Una collezione di marchi che pongono la qualità al centro dei propri obiettivi e che hanno scelto Italesse per veicolare con forza la propria immagine e portare a termine con successo il proprio business.

A range of companies that, placing quality at the forefront of their business, have chosen Italesse as the vehicle for promoting a strong image and support the success of their activities.

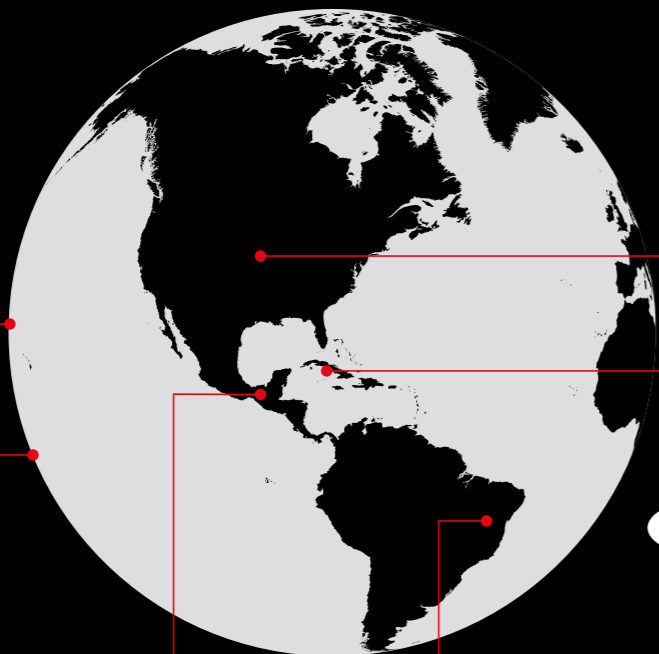

USA

Radisson HOTELS & RESORTS JACOB'S CREEK HYATT

ST. REGIS Hotels & Resorts Hilton HOTELS

JACK DANIEL'S OLD #7 MARIETTA MARRIOTT HOTELS • RESORTS • SUITES GREY GOOSE The World's Best Tasting Vodka

Coca-Cola Sheraton HOTELS & RESORTS

isetan

Japan

SHANGRI-LA HOTELS and RESORTS

Hong Kong

CERVEZA XX DOS EQUIS

Mexico

PISCELLI SUD

HOTEL DEVILLE PRIME Salvador

LUIZ ARGENTA VINHOS e ESPUMANTES

ASTOR

Brazil

Serapiá

REBATAIN

FAMÍLIA GEISSE Vinhedos de Terroir

VARANDA

VINHERIA PERCUSSI 30 ANOS

BACARDI ESTD CUBA 1862

Cuba

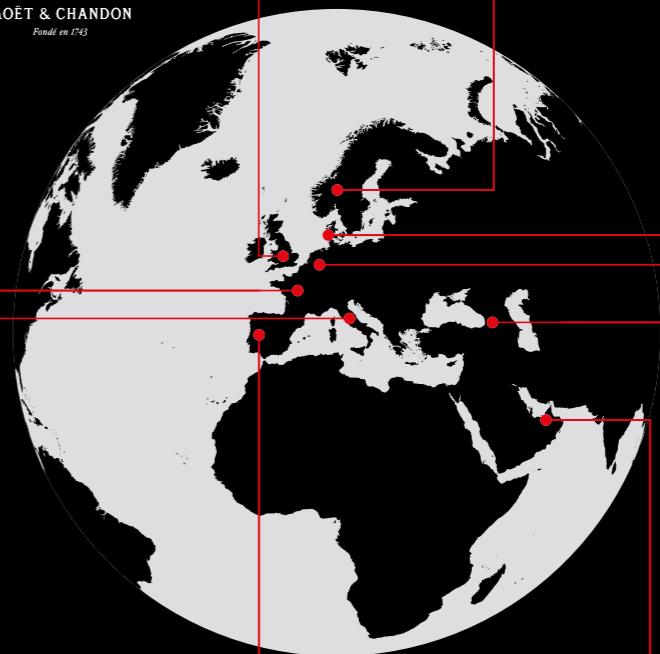

France

buddha-bar G.H. MUMM CHAMPAGNE TETÉDOIE

COINTREAU Hennessy COGNAC Paul Bocuse

Pernod Ricard Laurent-Perrier CHAMPAGNE ALAIN DUCASSE

PIPER-HEIDSIECK CHAMPAGNE PERRIER-JOUET MOËT & CHANDON Fondé en 1743

CHAMPAGNE Veuve Clicquot Ponsardin

Guida Berlucchi BERLUCCHI 1961-2011

APEROL CAMPARI

la Rinascente S.PELLEGRINO MIONETTO VALDOBBIADENE

NASTRO AZZURRO. roberto cavalli VODKA FERRARI METODO CLASSICO DAL 1902

MARTINI HOTEL MISSONI L'ALBERETA

Italy

United Kingdom

BOMBAY SAPPHIRE®

INTERCONTINENTAL HOTELS & RESORTS

BVLGARI HOTELS & RESORTS

Sweden

Nobis Hotel

ABSOLUT VODKA Country of Sweden

Denmark

Carlsberg

Holland

Heineken

Spain

BARBADILLO

San Miguel TORRES

Freixenet Mahou

Spain

BURJ AL ARAB

United Arab Emirates

ERISTOFF

Georgia

Personalizzazioni e decorazioni / Personalization & Decoration

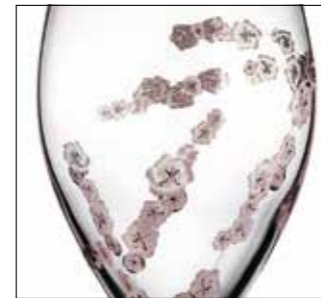

Collezioni / Collections

Wormwood Collection

Italesse presenta una collezione cocktail in grado di fondere un accattivante design in un prodotto tecnico e innovativo dedicato ai Bartender professionisti, ai Cocktail Bar premium e al mondo della Ospitalità | Italesse presents a cocktail collection that fuses an appealing design with a highly technical and innovative product concept dedicated to cocktail professionals, premium bars and the hospitality world

design by LUCA TRAZZI
concept by GIANCARLO MANCINO



Linea polifunzionale di calici e bicchieri: Wormwood si presta ad essere usata nei bar di tendenza e sulle tavole più caratteristiche | Wormwood, the polyfunctional line of stem glasses and tumblers, lends itself to service in trendy bars and the most characteristic tables



IT Con Wormwood Italesse propone ai professionisti una linea cocktail e una proposta tavola in sintonia con i trend attuali ed in particolare con il revival ispirato alla Belle Epoque. Partendo dal minimalismo del nuovo millennio, i bartender guardano oggi al futuro ricercando atmosfere art decò, evolvendo in chiave contemporanea il glamour d'inizio novecento. In linea con la mission di Italesse, la linea Wormwood è la sintesi tra un oggetto emozionale con un design forte e un prodotto tecnico. Wormwood è il risultato della collaborazione con uno dei più noti opinion leader del settore cocktail, Giancarlo Mancino e con il designer Luca Trazzi: due personalità forti, che hanno saputo unire un'estetica ricercata a un design in grado di valorizzare le creazioni cocktail. Italesse ha sintetizzato il lavoro in una collezione cocktail che anticipa i trend, proponendo ai professionisti prodotti tecnicamente evoluti capaci di attirare l'attenzione con il proprio fascino.

EN Italesse offers cocktail professionals a cocktail and dining collection in harmony with current trends that echo the revival of the roaring twenties. Leaving behind the minimalism that has characterized the beginning of the new millennium, today professionals in the cocktail field tend to favor warmer art deco settings, reinterpreting Belle Epoque elements with a markedly contemporary touch. In line with Italesse's mission, the Wormwood collection is the synthesis of a strong, emotional design and a fundamentally technical product. Wormwood is the result of the collaboration between one of the most distinguished opinion leaders of the cocktail world, Giancarlo Mancino and the renowned designer Luca Trazzi. These two strong personalities have ingeniously combined an intricate aesthetic with a design that elevates mixed drink creations. Italesse seamlessly marries the work of two key experts in a collection that anticipates trends and offers technically evolved products that catch the eye with their unique charm.



IT La collezione Wormwood si compone di sette calici e bicchieri pensati per il mondo dei grandi cocktail bar e la degustazione che garantisce un servizio originale ed elegante, dall'atmosfera retro pur con linee contemporanee. Completa la collezione il Gallone, un grande bicchiere a tulipano utilizzato dai barman per preparare interi cocktail miscelati, o più porzioni dello stesso cocktail contemporaneamente. Italesse ha scelto di arricchire tutti gli elementi della collezione Wormwood con un decoro inciso che richiama la pianta (artemisia) di assenzio. Volute di rami e foglie valorizzano le forme, creando un'ambientazione che sa essere contemporanea e di grande effetto, rendendo unica la presentazione dei cocktail.

EN The Wormwood collection is composed of seven glasses and stem glasses conceived for the world of grand cocktail bars and tasting that guarantees an innovative and elegant service that has retro feel yet is contemporary in its forms. The Gallone completes the classic cocktail collection, a large tulip-shaped mixing glass used by bartenders to mix cocktails or to make more than one serving of the same drink at a time. Italesse has embellished the collection with a decorative pattern, an ethereal engraving whose motif features the absinthe (wormwood) plant. Spiraling branches and leaves heighten the glassware's forms, contemporary and highly effective, rendering cocktail presentation truly original.



WORMWOOD GALLONE

art. 1404

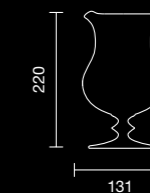
MATERIALE / MATERIAL
Vetro soffiato a bocca /
Mouth-blown glassCAPACITÀ / CAPACITY
1000 ccCOLORI / COLOURS
Clear Pattern

WORMWOOD ALTO-BALL

art. 3352

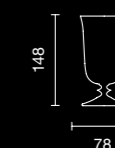
MATERIALE / MATERIAL
Vetro cristallino /
Crystalline glassCAPACITÀ / CAPACITY
310 ccCOLORI / COLOURS
Clear Pattern

WORMWOOD DOUBLE PRESIDENTE

art. 3372

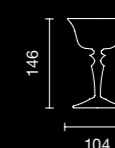
MATERIALE / MATERIAL
Vetro cristallino /
Crystalline glassCAPACITÀ / CAPACITY
220 ccCOLORI / COLOURS
Clear Pattern

WORMWOOD GALANTE

art. 3349

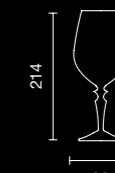
MATERIALE / MATERIAL
Vetro cristallino /
Crystalline glassCAPACITÀ / CAPACITY
490 ccCOLORI / COLOURS
Clear Pattern

WORMWOOD ASTORIA

art. 3371

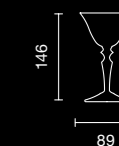
MATERIALE / MATERIAL
Vetro cristallino /
Crystalline glassCAPACITÀ / CAPACITY
130 ccCOLORI / COLOURS
Clear Pattern

WORMWOOD PRESIDENTE

art. 3370

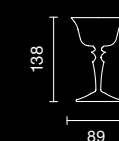
MATERIALE / MATERIAL
Vetro cristallino /
Crystalline glassCAPACITÀ / CAPACITY
135 ccCOLORI / COLOURS
Clear Pattern

WORMWOOD ROCK-GOBBLER

art. 3351

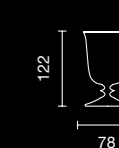
MATERIALE / MATERIAL
Vetro cristallino /
Crystalline glassCAPACITÀ / CAPACITY
230 ccCOLORI / COLOURS
Clear Pattern

WORMWOOD FIZZ

art. 3038

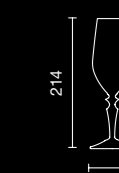
MATERIALE / MATERIAL
Vetro cristallino /
Crystalline glassCAPACITÀ / CAPACITY
260 ccCOLORI / COLOURS
Clear Pattern

Etoilé Collection

Calici ufficiali dell'associazione Maîtres Cuisiniers de France, stile e performance sotto una nuova luce. Elegante, sinuosa, di classe cristallina, esercizio di stile purissimo: è così che si presenta la collezione Etoilé sulle tavole dei ristoranti stellati e più raffinati | The official Maîtres Cuisiniers de France glassware range, style and performance under a new light. Elegant, sinuous and crystalline class, pure style: this is how the Etoilé collection appears on the tables of the finest and Michelin-starred restaurants

concept by MAÎTRES CUISINIERS DE FRANCE
design by ITALESSE and LUCA BINI



IT Coppe tecniche con forme e caratteristiche ideali per la degustazione, atte ad esaltare tutte le complesse proprietà organolettiche e olfattive del vino, e capaci di sposarsi con tutte le sue tipologie. I gambi realizzati in automatico dei calici Noir e Blanc, dalla caratteristica altezza, sono pura eleganza: sottili e resistenti, realizzati in un pezzo unico, lunghi e slanciati, emergono tra tutti, perfette anime gemelle delle coppe tecniche. Il calice Sparkle si presenta come una vera rivoluzione per il mondo della degustazione di spumanti e Champagne: coppa più ampia, corpo elegantemente alto, sette punti di perlage. I tumbler Etoilé Cristal ed Etoilé Cristal Small sono adatti a servire l'acqua in modo straordinario. Etoilé è una collezione realizzata in vetro Xtreme®, materiale di eccezionale sottigliezza e resistenza, che soddisfa al tempo stesso esigenze estetiche e di servizio tanto impegnative, con performance altissima. Presentando infatti coppa e gambo realizzati in un unico pezzo e un piattello attaccato prima della stiratura dello stelo, il calice è adatto anche alle situazioni "estreme" che necessitano di maggior resistenza.

EN Technical bowls with shapes and features ideal for wine tasting, designed to elevate all the complex organic and olfactory properties of all types of wine. The stems of the Noir and Blanc glasses possess a characteristic height. Pure elegance: fine and resistant, long and slender, perfectly matching technical bowls that stand out from the crowd. The Sparkle stem glass is a true revolution for the world of Champagne and sparkling wine tasting: a wide bowl, elegantly high body with seven perlage points. The Etoilé Cristal and Etoilé Cristal Small tumblers is suitable for serving water in an extraordinary way. The Etoilé collection is made with Xtreme® glass, an exclusive, exceptionally fine and resistant material, that satisfies at the same time the demanding aesthetic and service requirements, with very high performance. The bowl and stem are made in a single piece and the base is attached before pulling the stem, thus, the glass is well suited to "extreme" conditions that require greater resistance.



ETOILÉ NOIR

art. 3361

MATERIALE / MATERIAL
Vetro cristallino Xtreme® soffiato
in automatico in assenza di piombo /
Lead free automatically blown
crystalline Xtreme® glass

CAPACITÀ / CAPACITY
790 cc

COLORI / COLOURS
Clear

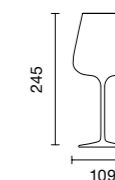

ETOILÉ BLANC

art. 3360

MATERIALE / MATERIAL
Vetro cristallino Xtreme® soffiato
in automatico in assenza di piombo /
Lead free automatically blown
crystalline Xtreme® glass

CAPACITÀ / CAPACITY
570 cc

COLORI / COLOURS
Clear

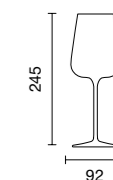

ETOILÉ SPARKLE

art. 3055

MATERIALE / MATERIAL
Vetro cristallino Xtreme® soffiato
in automatico in assenza di piombo /
Lead free automatically blown
crystalline Xtreme® glass

CAPACITÀ / CAPACITY
480 cc

COLORI / COLOURS
Clear

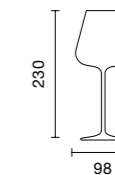

ETOILÉ CRISTAL

art. 3359

MATERIALE / MATERIAL
Vetro / Glass

CAPACITÀ / CAPACITY
400 cc

COLORI / COLOURS
Clear Black Transparent

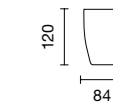

ETOILÉ CRISTAL SMALL

art. 3358

MATERIALE / MATERIAL
Vetro / Glass

CAPACITÀ / CAPACITY
350 cc

COLORI / COLOURS
Clear

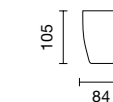

Etoilé Cristal - Colori / Colours

Etoilé Sparkle

Un calice che ha il sapore della sfida e il fascino dell'innovazione. Etoilé Sparkle è un prodotto unico, ideato da Luca Bini e dedicato alla degustazione degli spumanti ottenuti con metodo classico / A stem glass that carries with it the spirit of challenge and the wonder of innovation. Etoilé Sparkle is a unique piece, conceived by Luca Bini and destined for the tasting of sparkling wines made using the classic method

design by LUCA BINI



Chiusura della bocca stretta

Con una bocca stretta, il calice ricorda la silhouette di un tulipano chiuso e coniuga una completa esperienza di degustazione a un design armonico ed elegante. La particolare chiusura incanala l'aroma dei vini verso il naso e la bocca.

Narrow mouth diameter. The glass takes the form of a closed tulip, designed to bring harmony and elevate the tasting experience. This stem glass features a narrow mouth that channels the wine's aromas to the nose and mouth.

Fondo piano e larghezza della coppa

Evocando l'iconica coppa di Champagne, il fondo di Sparkle è volutamente ampio, al fine di permettere al perlage di salire in superficie e, così facendo, di raccogliere aromi e profumi nel centro della coppa. Sparkle infatti, è disegnato per esaltare tutte le caratteristiche organolettiche del vino senza perdere le qualità pregiate, evitando così il limite tecnico comunemente associato alla coppa.

Flat base and bowl width. Evoking the iconic Champagne coupe, the bowl of this unique sparkling wine glass is intentionally broad to allow the perlage to quickly rise to the surface and by doing so, release its fragrant qualities. In contrast with the open coupe, however, aromas collect in the middle of the glass by virtue of the bowl's tapering shape. Sparkle's features hence allow for the full expression of the wine's organoleptic attributes without dispersing them; a technical limitation of the coupe.

Punti perlage

Sei incisioni equidistanti tra loro lungo una circonferenza di raggio 20 millimetri e una centrale posizionata immediatamente sopra allo stelo del calice: Sparkle propone un innovativo sistema di perlage, in grado di accrescerlo, animando così il vino e intensificando l'esperienza della degustazione. L'effetto visivo prolunga il fascino della degustazione e risveglia i sensi.

Perlage points. Six equidistant micro-incisions etched in a 20mm circumference on the bowl's base and another placed centrally over the glass's stem are an important feature of Sparkle. These etchings serve to promote and heighten perlage, enlivening the wine and enhancing the wine tasting experience. The perlage opens up the wine's subtlest flavors and ensures a lasting visual effect.



Altezza della coppa, pareti affusolate

Sparkle si presenta con pareti affusolate e ripide che reinterpretano la forma della tradizionale flûte, il classico senza tempo per la degustazione di Champagne e spumanti. La coppa è ideata per dirigere il vino direttamente alla lingua, e per consentire così una valutazione immediata della qualità.

Bowl height and straight, tapering walls. Sparkle possesses straight walls that reinterpret those of the traditional flute, a timeless classic for tasting Champagnes and sparkling wines. This stemware, revives these elements in its own contemporary key to direct the flow of the wine directly onto the tongue, allowing for an immediate appreciation of the vintage's qualities.

Fascino e tecnica

La lunghezza e l'eleganza del gambo unisce fascino e tecnica al calice. Oltre a creare un effetto scenico, posizionando la mano alla giusta distanza dal calice, la dimensione dello stelo evita il trasferimento del calore, garantendo l'ottimale temperatura di degustazione.

Long, elegant stem. Aside from adding allure to the design, this long, elegant stem also carries a functional purpose. The length of the stem ensures the hand holds the glass at an ideal distance from the wine to avoid the transfer of heat and guarantee the glass's contents remain at an optimal temperature for tasting.

Etoilé Sparkle

art. 3055

MATERIALE / MATERIAL
Vetro cristallino Xtreme® soffiato in automatico in assenza di piombo / Lead free automatically blown crystalline Xtreme® glass

CAPACITÀ / CAPACITY
480 cc

COLORI / COLOURS
Clear



Etoilé Excellence® Collection

Dotata di rara bellezza, la linea Etoilé Excellence® porta in tavola l'eccellenza della forma e l'assoluta eleganza del vetro artigianale, che risiede nella sua cristallina trasparenza e leggerezza | Uncommonly beautiful, Etoilé Excellence® collection is born to express the very notion of hand-made glass excellence, grace, levity

design by ITALESSE



ETOILÉ NOIR EXCELLENCE

art. 3347

MATERIALE / MATERIAL
Vetro cristallino Excellence® soffiato a bocca e lavorato a mano / Excellence® mouth-blown hand-crafted crystalline glass

CAPACITÀ / CAPACITY
760 cc

COLORI / COLOURS
Clear



ETOILÉ BLANC EXCELLENCE

art. 3346

MATERIALE / MATERIAL
Vetro cristallino Excellence® soffiato a bocca e lavorato a mano / Excellence® mouth-blown hand-crafted crystalline glass

CAPACITÀ / CAPACITY
550 cc

COLORI / COLOURS
Clear



ETOILÉ D'OR EXCELLENCE

art. 3057

MATERIALE / MATERIAL
Vetro cristallino Excellence® soffiato a bocca e lavorato a mano / Excellence® mouth-blown hand-crafted crystalline glass

CAPACITÀ / CAPACITY
330 cc

COLORI / COLOURS
Clear



ETOILÉ CRISTAL EXCELLENCE

art. 3348

MATERIALE / MATERIAL
Vetro cristallino Excellence® soffiato a bocca e lavorato a mano / Excellence® mouth-blown hand-crafted crystalline glass

CAPACITÀ / CAPACITY
400 cc

COLORI / COLOURS
Clear

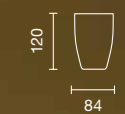

Tiburón Collection

*Una linea di calici e bicchieri creati per la degustazione professionale, caratterizzata da linee aggressive ed eleganti |
A line of wineglasses and tumblers for professional tasting, characterised by aggressive yet elegant forms*

design by ITALESSE



IT La linea Tiburón, collezione che deve l'ispirazione delle sue curve ardite ed aggressive alla forma di un potente squalo, è formata da pregiati calici e bicchieri. I calici della collezione presentano una piquère dalla linea profonda e tagliente concepita per percepire la reale colorazione del vino, mentre la coppa ne esalta la massa. La sciancratura della parte bassa della coppa permette, inoltre, che il vino si sviluppi nella parte superiore, favorendone l'ossigenazione. Realizzati con la tecnologia brevettata Xtreme® e grazie ai contorni angolati, questi calici risultano altamente resistenti. Le stesse caratteristiche di robustezza contraddistinguono anche i due flûte, pensati per servire pregiati spumanti e champagne che necessitano di particolare ossigenazione. Il flûte da 220 cc è ideale anche per servire vini da dessert, vini liquorosi o distillati. La collezione si completa con i Tiburón Bar e Tumbler per servire acqua, birre e cocktail.

EN The Tiburón line, a collection inspired by the bold and aggressive shapes of the potent shark, consists of fine glasses and tumblers. The stem glasses of the collection feature a deep piquère designed for the appreciation of the wine's true color, whilst the glass' wide bowl enhances its mass. The large width of the bowl serves, moreover, to develop the wine's fragrances in the top section thus favoring oxygenation. Made of Italesse's patented Xtreme® technology glass, the angled contours of the stemware serve to reinforce the resistance of the glass against breakage. Possessing the same Xtreme® technology, the two flutes of the collection are designed for serving fine sparkling wines and champagnes that require ample bowls for the release of their delicate fragrances. The 220 cc flute is also ideal for serving dessert wines, fortified wines or distillates. The Tiburón Bar and the Tiburón Tumbler complete the collection and are perfect for serving water, select beers or cocktails.



TIBURÓN LARGE

art. 3340

MATERIALE / MATERIAL
Vetro cristallino Xtreme® soffiato in automatico in assenza di piombo / Xtreme crystalline® automatic blown glass with no lead

CAPACITÀ / CAPACITY
620 cc

COLORI / COLOURS
Clear

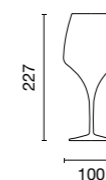

TIBURÓN MEDIUM

art. 3341

MATERIALE / MATERIAL
Vetro cristallino Xtreme® soffiato in automatico in assenza di piombo / Xtreme crystalline® automatic blown glass with no lead

CAPACITÀ / CAPACITY
500 cc

COLORI / COLOURS
Clear



TIBURÓN GRAN CRU

art. 3053

MATERIALE / MATERIAL
Vetro cristallino Xtreme® soffiato in automatico in assenza di piombo / Xtreme crystalline® automatic blown glass with no lead

CAPACITÀ / CAPACITY
380 cc

COLORI / COLOURS
Clear

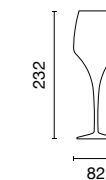

TIBURÓN FLÛTE

art. 3052

MATERIALE / MATERIAL
Vetro cristallino Xtreme® soffiato in automatico in assenza di piombo / Xtreme crystalline® automatic blown glass with no lead

CAPACITÀ / CAPACITY
220 cc

COLORI / COLOURS
Clear



TIBURÓN BAR

art. 0037

MATERIALE / MATERIAL
Vetro cristallino soffiato in automatico in assenza di piombo / Crystalline automatic blown glass with no lead

CAPACITÀ / CAPACITY
430 cc

COLORI / COLOURS
Clear

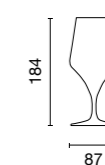

TIBURÓN TUMBLER

art. 3342

MATERIALE / MATERIAL
Vetro colorato soffiato a bocca e lavorato a mano / Mouth-blown, hand-crafted coloured glass

CAPACITÀ / CAPACITY
350 cc

COLORI / COLOURS
White Black Transp.

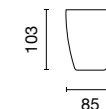

Vertical Collection

*Una linea di calici e tumbler tecnici e polifunzionali,
adatti a tutte le tavole | A technical and multifunctional
glassware range, suited to every table*

IT Vertical è la collezione di calici e tumbler in vetro cristallino Xtreme® dall'eleganza raffinata e dalle caratteristiche altamente tecniche. La linea è formata da calici vino e flûte pensati per la degustazione di grandi vini. I calici sono dotati di una profonda piqûre per favorire il perlage e grazie all'accurato design, risultano adatti a molteplici utilizzi. I calici Vertical sono realizzati con tecnologia Xtreme®, caratteristica che rende la collezione altamente resistente e quindi adatta ad ogni ambiente e situazione, anche le più "estreme", per aperitivi, cene e feste all'insegna dello stile e della sicurezza. Vertical si completa con un tumbler polifunzionale, perfetto per servire acqua, soft drink e colorati cocktail.

EN Vertical is a collection of refined and elegant crystalline Xtreme® glasses with highly technical features. The line consists of wine glasses and flutes for serving and tasting of fine wines. The wine glasses of the Vertical Collection feature a special piqûre that enhances perlage and their carefully studied design renders them suitable for multiple applications. Produced using Xtreme® technology glass, optimum performance and high resistance to breakage is guaranteed with this glassware range, making this collection particularly suitable for all environments and settings, including "extreme" situations: apéritifs, cocktail parties and dinners to be enjoyed in style and absolute safety. The Vertical Line is completed by a multifunctional tumbler perfect for serving water, soft-drinks and colorful cocktails.



VERTICAL LARGE

art. 3304

MATERIALE / MATERIAL
Vetro cristallino Xtreme® soffiato in automatico in assenza di piombo / Xtreme® Crystalline automatic blown glass with no lead

CAPACITÀ / CAPACITY
500 cc

COLORI / COLOURS
Clear



VERTICAL MEDIUM

art. 3308

MATERIALE / MATERIAL
Vetro cristallino Xtreme® soffiato in automatico in assenza di piombo / Xtreme® Crystalline automatic blown glass with no lead

CAPACITÀ / CAPACITY
390 cc

COLORI / COLOURS
Clear



PRIVÉ GRAN CRU

art. 3049

MATERIALE / MATERIAL
Vetro cristallino Xtreme® soffiato in automatico in assenza di piombo / Xtreme® Crystalline automatic blown glass with no lead

CAPACITÀ / CAPACITY
330 cc

COLORI / COLOURS
Clear



PRIVÉ FLÛTE

art. 3048

MATERIALE / MATERIAL
Vetro cristallino Xtreme® soffiato in automatico in assenza di piombo / Xtreme® Crystalline automatic blown glass with no lead

CAPACITÀ / CAPACITY
150 cc

COLORI / COLOURS
Clear



MASTER

art. 3309

MATERIALE / MATERIAL
Vetro / Glass

CAPACITÀ / CAPACITY
315 cc

COLORI / COLOURS
Clear

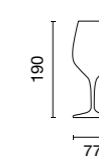

VERTICAL PARTY

art. 3310

MATERIALE / MATERIAL
Vetro cristallino soffiato in automatico in assenza di piombo / Crystalline automatic blown glass with no lead

CAPACITÀ / CAPACITY
420 cc

COLORI / COLOURS
Clear White

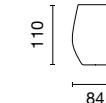

Bora Collection

La linea Bora è una collezione di calici polifunzionali dalle linee essenziali e performance avanzate | The Bora Line is a range of multifunctional stemglasses characterized by advanced performance and essential lines

design by ITALESSE



IT Una linea di tre calici, il Medium, il Large e il Flûte, che si contraddistingue per robustezza, grazie alla tecnologia pull-stem. Il bevante sottile di questi calici ottenuto dal taglio a laser, garantisce una nuova esperienza della degustazione, più piacevole e più raffinata, e che rende la linea Bora adatta per tutti i tipi di vini.

EN A line of stem glasses consisting of three elements, Bora Medium, Bora Large and Bora Flute, distinguished by robustness thanks to the pull-stem technology with which it is made. Bora's delicate, laser-cut rim heightens the tasting experience rendering it more enjoyable and sophisticated, making it suitable for serving all types of wine.

BORA LARGE

art. 3323

MATERIALE / MATERIAL
Vetro / Glass

CAPACITÀ / CAPACITY
500 cc

COLORI / COLOURS
Clear



BORA MEDIUM

art. 3324

MATERIALE / MATERIAL
Vetro / Glass

CAPACITÀ / CAPACITY
390 cc

COLORI / COLOURS
Clear

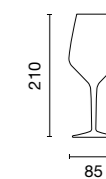

BORA FLÛTE

art. 3054

MATERIALE / MATERIAL
Vetro / Glass

CAPACITÀ / CAPACITY
280 cc

COLORI / COLOURS
Clear



Easy Collection

Calici da vino dalle linee semplici ed armoniose ma con valenze tecnicamente performanti, perfetti per la degustazione professionale / Wine stemware line with simple proportions and shapes that deliver high performance, ideal for professional tasting

design by ITALESSE

IT I calici della linea Easy sono convenienti e performanti e si declinano in diverse capacità. Un calice maxi, Easy Big, per grandi vini invecchiati che necessitano di particolare ossigenazione, un bicchiere per il vino di formato large, Easy Large, per degustazioni di qualsiasi tipo di vino o aperitivo ed un calice per il vino di formato medio, Easy Medium, dalle dimensioni più ridotte, per degustare vini più freschi e giovani.

EN The Easy line is composed of convenient and high-performance wine stem glasses. The larger format glass, Easy Big, for great aged wines that require special oxygenation; a large stem glass for tasting all types of wines or cocktails; a medium white wine stem glass, of a smaller size, for younger and fresh wines.



EASY BIG

art. 3322

MATERIALE / MATERIAL
Vetro / Glass

CAPACITÀ / CAPACITY
760 cc

COLORI / COLOURS
Clear



EASY LARGE

art. 3321

MATERIALE / MATERIAL
Vetro / Glass

CAPACITÀ / CAPACITY
500 cc

COLORI / COLOURS
Clear



EASY MEDIUM

art. 3320

MATERIALE / MATERIAL
Vetro / Glass

CAPACITÀ / CAPACITY
380 cc

COLORI / COLOURS
Clear



Dolcevita & Mastro

Due calici adatti al servizio professionale, ideali per le situazioni e gli ambienti del mondo del vino e della birra che richiedono particolare resistenza / Two stem glasses apt for professional service, ideal for serving wine and beer in all those situations and environments that require high resistance

design by ITALESSE

IT Il calice polifunzionale Dolcevita, presenta linee pulite e semplici ed è dotato di particolare robustezza per offrire ottime performance di servizio. È perfetto per degustare tutti i tipi di vino, ma anche per servire aperitivi in modo originale e con stile. Mastro è un calice universale in vetro per la degustazione della birra. Ideato per esaltare la schiuma, il gusto e consentire il pieno sviluppo degli aromi della birra. Resistente, è perfetto per l'utilizzo professionale.

EN Dolcevita multifunctional stem glass with clean and linear forms is particularly robust to offer excellent service performance. It is ideal for serving all type of wines as well as original aperitifs with style. Mastro is a universal stemware for beer tasting. Designed for enhancing the foam and the taste, it allows the correct development of beer's aromas. Resistant, it is perfect for the professional use.



DOLCEVITA

art. 3374

MATERIALE / MATERIAL
Vetro / Glass

CAPACITÀ / CAPACITY
470 cc

COLORI / COLOURS
Clear

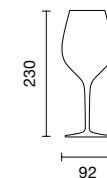

MASTRO

art. 3369

MATERIALE / MATERIAL
Vetro / Glass

CAPACITÀ / CAPACITY
420 cc

COLORI / COLOURS
Clear



Richard Juhlin Optimum

È il calice perfetto per la degustazione dello Champagne: da un'intuizione di Italesse, il calice Optimum prende forma grazie alla collaborazione di Richard Juhlin, uno dei massimi esperti internazionali di Champagne, con Claesson Koivisto Rune, uno dei più apprezzati atelier di design nel mondo | The perfect Champagne glass: based on the intuition of Italesse, the Richard Juhlin Optimum has taken shape thanks to the collaboration of Richard Juhlin, one of the top international Champagne experts, with Claesson Koivisto Rune, one of the most appreciated design firms in the world

concept by RICHARD JUHLIN
design by CLAESSON KOIVISTO RUNE

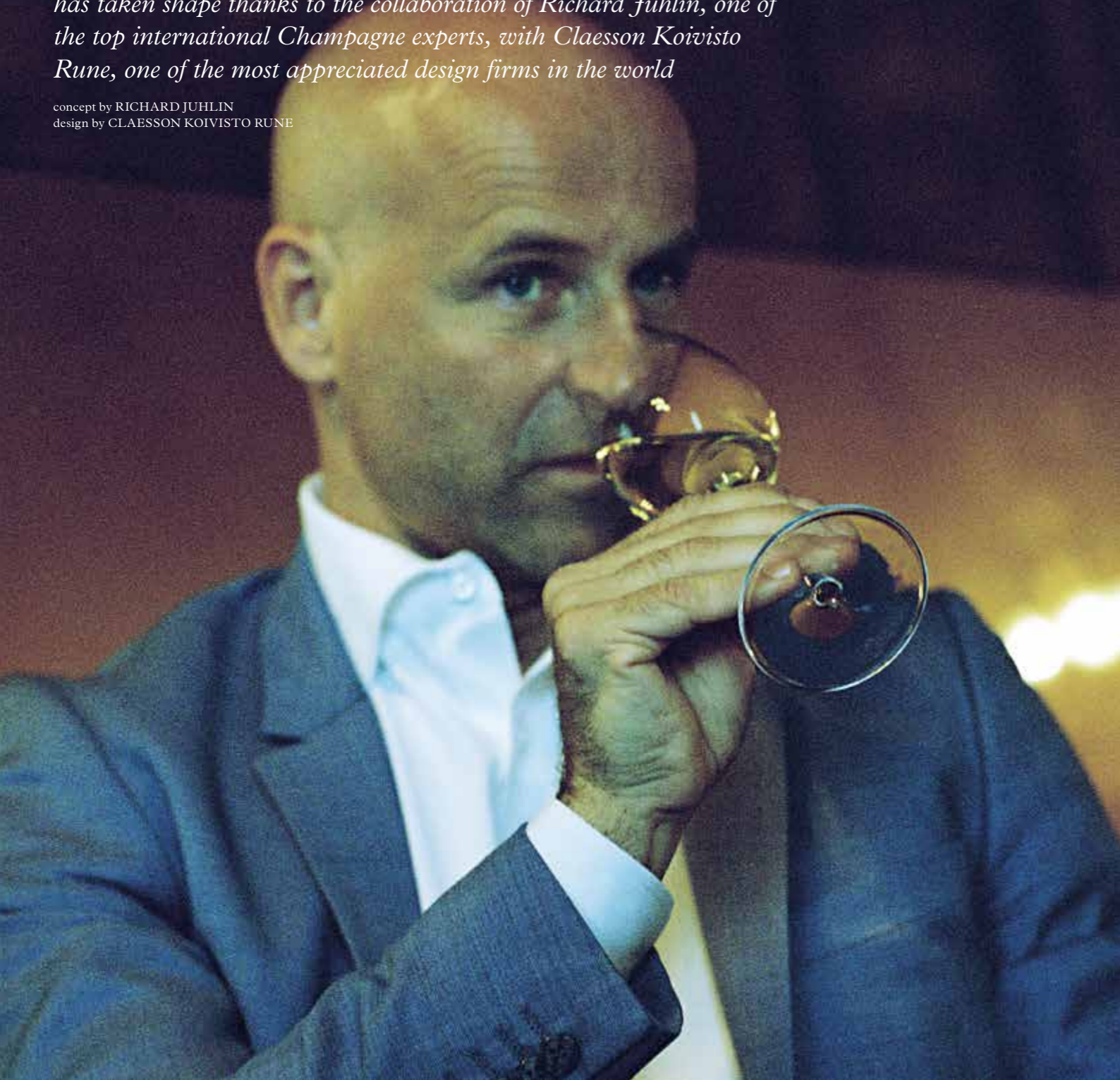

Diametro della bocca

Il bevande è proporzionato all'altezza e all'angolo della coppa. La bocca è chiusa tanto quanto basta per permettere allo Champagne di indirizzare al naso fragranze e aromi nel migliore modo possibile.

Mouth diameter. The rim is proportional to the height and angle of the bowl. It is closed just enough to allow the Champagne to direct the fragrances and aromas perfectly towards the taster's nose.

Ampiezza della coppa

Il diametro massimo della coppa corrisponde al livello ottimale di servizio: è quell'ottimale superficie di Champagne, che esposta all'aria sovrastante e contenuta nella coppa, rilascia gli aromi e le fragranze nel modo più efficace possibile. È a questo livello (9cl.) che è stata apposta (su una versione del calice da Champagne) una linea decorativa e funzionale.

Bowl width. The maximum diameter of the bowl corresponds to an optimal quantity and surface area exposure of Champagne to the air. This is the "Juhlin line", the ideal measurement for releasing Champagne aromas and fragrances in the best possible manner.

Punto Perlage e piqûre

Il fondo della coppa del calice ospita una profonda piqûre, dove si formano le bollicine (propagate al centro della coppa) e dove il punto laser perlage moltiplica l'effetto, generando una maggiore quantità di bollicine.

Perlage Point and Piqûre. The bowl depth is conceived to favour perlage in the centre of the glass, for perfect tasting. Inside the piqûre, on the bottom, there is a circular ring comprised of numerous small micro-etchings on the glass surface: this is the perlage point. When the Champagne is poured into the glass long bubble chains are produced (known as perlage) and the effect is long-lasting.

Altezza della coppa

La dimensione totale della coppa è studiata tecnicamente ed è perfettamente bilanciata. Sia nella profondità della picure nella parte bassa, che nell'altezza e nell'angolazione di chiusura della coppa nella parte superiore – detta cheminée – per concentrare e canalizzare gli aromi e i profumi verso il naso e la bocca.

Bowl Height. Perfectly balanced dimensions along the entire height of the glass, both at the bottom, in terms of the depth of the piqûre, and in the angle of the cheminée, i.e. the angle at which the bowl gradually closes. A technically impeccable shape: the generosity of the "Juhlin line" enhances the virtues of champagne, while the significantly taller cheminée ensures the right distance for tasting, concentrating the aromas and fragrances of the champagne to the perfect intensity and channelling them harmoniously towards nose and mouth.

Curva rientrante

La base della coppa ha una curva rientrante, che oltre a definirne la forma tecnica, esalta l'identità del calice e le dona quel tocco di contemporaneità imprescindibile.

Inward Curve. The extreme delicacy of the glass that sinuously coils towards the stem designs a light, gentle curve and gives the RJ Optimum a unique iconic identity.



RICHARD JUHLIN OPTIMUM

art. 3056

MATERIALE / MATERIAL
Vetro cristallino /
Crystalline glass

CAPACITÀ / CAPACITY
290 cc

COLORI / COLOURS
Clear

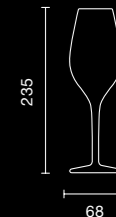

Balloon Collection

Flûte che rievocano le forme dei calici da vino tradizionali balloon, realizzati per una proposta di servizio innovativo in linea con le nuove tendenze di degustazione e di consumo del mondo dello Champagne - scenico ed elegante | Flutes that evoke the silhouette of traditional wine tasting balloon glasses and deliver an innovative proposal for service that follows the latest tasting and consumption trends in Champagne - dramatic, sophisticated

IT La serie Balloon si compone di tre calici: Balloon Flûte, Grand Balloon Flûte e Balloon Magnum Flûte, tutti caratterizzati da ampie coppe disegnate per sviluppare gli aromi di Champagne e vini spumanti e da bocca chiusa per indirizzarli ai sensi nella degustazione. Una profonda piquère, con un punto perlage inciso al laser, esalta la qualità, la finezza e la persistenza delle catenelle di bollicine. Il Balloon Magnum Flûte si distingue per la sua realizzazione con un vetro soffiato a bocca e lavorato a mano Excellence®. Balloon Flûte e Grand Balloon Flûte sono realizzati con vetri Xtreme® resistenti agli urti, alla torsione e alle rotture nel punto critico di saldatura tra gambo e piattello. Balloon Magnum Flûte si differenzia per la produzione in vetro soffiato a bocca e lavorato a mano: la sua coppa ampia è ideale per la degustazione dei più pregiati Champagnes che necessitano di particolare ossigenazione.

EN The Balloon Flute series is composed of three elements: the Balloon Flute, the Grand Balloon Flute and the Balloon Magnum Flute, all featuring the same forms characterized by ample bowls designed to develop the delicate aromas of Champagne and sparkling wines, channeled towards the senses when tasting by virtue of its tapering mouth. A deep piquère at the base of the flute's bowl that possesses a laser-etched perlage point enhances the quality, finesse and persistence of wine's effervescence. The Balloon Flute and the Grand Balloon Flute are produced using Xtreme® patented glass, resistant to shocks and torsion as well as breakage at the critical fusion point between the stem and the base plate. The Balloon Magnum Flute, distinguishing itself by its prized mouth-blown hand-made Excellence® quality glass, possesses a particularly large bowl that makes it perfect for tasting of the most prized Champagnes that require optimum oxygenation.



BALLOON MAGNUM FLÛTE

art. 3037

MATERIALE / MATERIAL
Vetro cristallino Excellence® soffiato a bocca e lavorato a mano / Excellence® mouth-blown hand-crafted crystalline glass

CAPACITÀ / CAPACITY
450 cc

COLORI / COLOURS
Clear



GRAND BALLOON FLÛTE

art. 3036

MATERIALE / MATERIAL
Vetro Xtreme® soffiato in automatico in assenza di piombo / Automatically blown, lead free Xtreme® glass

CAPACITÀ / CAPACITY
380 cc

COLORI / COLOURS
Clear



BALLOON FLÛTE

art. 3035

MATERIALE / MATERIAL
Vetro Xtreme® soffiato in automatico in assenza di piombo / Automatically blown, lead free Xtreme® glass

CAPACITÀ / CAPACITY
210 cc

COLORI / COLOURS
Clear



Riviera & Flûte N°5

Riviera & Flûte N°5 entrano a far parte della collezione flûte Italesse, ambendo a diventare nuove icone per piccoli e grandi produttori di spumanti e Champagne, che fin da subito ne apprezzeranno la forma raffinata e l'elevata prestazione tecnica | Riviera & Flûte N°5 join Italesse's flute collection with the objective of becoming flutes of reference for small and large producers of sparkling wines and Champagne that will appreciate their sophisticated forms and their technical performance

design by ITALESSE



IT Riviera è una flûte da degustazione per Champagne e vini frizzanti, moderna, resistente e dalla forte personalità. Gambo slanciato e punto perlage inciso a laser in una profonda piquère, la rendono una flûte distintiva. Ideale in una degustazione professionale, è declinato in tre capacità, risultando il calice ideale per ogni esigenza di servizio. Il modello da 14 cl, in particolare, ben si presta a servire vini dolci, grappe, distillati d'uva e liquori. Capacità superiori per Flûte N°5, flûte professionale da degustazione dal design pulito e minimale con coppa stretta e gambo sottile ma molto resistente, da 28 cc.

EN Riviera is a tasting flute for Champagnes and sparkling wines, modern, resistant and with strong personality. A slender stem and a laser-made perlage point in its deep piqueure make this a distinctive flute. Ideal for professional tasting, it is available in three different volumes, that makes it the ideal flute for all service needs. The 14 cl model is also well-adapted for the service of sweet wines, digestifs and liqueurs. Flûte N°5 with a capacity of 28 cc, is a flûte for professional tasting with a clean and minimal design a narrow bowl and a thin, yet very strong stem.



FLÛTE N°5

art. 3059

MATERIALE / MATERIAL
Vetro cristallino Xtreme® soffiato in automatico in assenza di piombo / Xtreme® Crystalline automatic blown glass with no lead

CAPACITÀ / CAPACITY
280 cc

COLORI / COLOURS
Clear



RIVIERA 17

art. 3070

MATERIALE / MATERIAL
Vetro / Glass

CAPACITÀ / CAPACITY
170 cc

COLORI / COLOURS
Clear



RIVIERA 16

art. 3069

MATERIALE / MATERIAL
Vetro / Glass

CAPACITÀ / CAPACITY
160 cc

COLORI / COLOURS
Clear

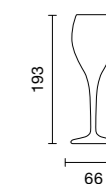

RIVIERA 14

art. 3068

MATERIALE / MATERIAL
Vetro / Glass

CAPACITÀ / CAPACITY
140 cc

COLORI / COLOURS
Clear

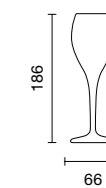

Vertigo Tumbler

Classe ed eleganza nella lavorazione artistica del vetro soffiato colorato / Elegance and class in the artistic craftsmanship of mouth-blown colored glass

design by ITALESSE



IT Bicchieri unici e di grande raffinatezza, realizzati in vetro soffiato a bocca e lavorati a mano da esperti mastri vetrai. Un'innovativa spirale caratterizza Vertigo Tumbler con delle scanalature sia interne che esterne, impreziosendolo ulteriormente in termini di dinamicità e colorazione. Vertigo Tumbler è disponibile in più colori, con capacità 380 cc. Un bicchiere ideale per la tavola e perfetto per servire acqua e altre bevande con straordinaria eleganza.

EN Unique and refined drinking glasses made of mouth-blown, hand crafted glass by expert master craftsmen. An innovative spiral design characterizes the Vertigo Tumbler creating internal and external ridges that enliven the glass further with dynamism and color. Vertigo tumbler is available in various hues and has a capacity of 380 cc. This collection is ideal for sophisticated table settings and serving other beverages with extraordinary elegance.

VERTIGO TUMBLER

art. 3353

MATERIALE / MATERIAL
Vetro colorato soffiato a bocca e lavorato a mano / Mouth-blown, hand-crafted coloured glass

CAPACITÀ / CAPACITY
380 cc

COLORI / COLOURS

Clear & White



Blue & White



Green & White



Black & White



Amber & White



Red & White

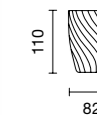

Mares Collection

Nata per stupire e realizzata a mano da mastri vetrai orientali, la linea Mares è composta da coloratissimi bicchieri creati con una tecnica produttiva che ha radici antiche | Made by hand by oriental glassware craftsmen to astonish and surprise, the Mares Tumblers are extremely colourful glasses produced using manual manufacturing techniques with ancient roots

design by ITALESSE



IT La collezione Mares è nata per stupire. Realizzati a mano da mastri vetrai orientali, i tumbler Mares sono coloratissimi bicchieri creati con una tecnica produttiva che ha radici antiche. La collezione si compone di tumbler preziosi, soffiati a bocca utilizzando melange di paste di vetro colorate: in un giorno ne vengono realizzati solo sessanta, e sono pezzi unici. Uno diverso dall'altro, decorano la tavola e la rendono singolare ed indimenticabile. La collezione Mares propone colori scelti pensando al mondo subacqueo delle barriere coralline, dove l'esplosione di nuances di piante e pesci tropicali ammalia e sorprende. La particolarità di questi bicchieri risiede proprio nella capacità di attrarre l'attenzione: da tumbler sanno trasformarsi in oggetti decorativi perfetti in tavola anche come ornamenti artistici.

EN The Mares collection is made to surprise. Made by hand by oriental glassware craftsmen, the Mares Tumblers are extremely colourful glasses produced using manual manufacturing techniques with ancient roots. The collection includes a series of tumblers made of mouth-blown coloured glass paste melanges using a technique that allows for up to a maximum of only sixty pieces a day. Completely different from one another, these tumblers decorate the table rendering it truly singular and unforgettable. The Mares collection proposes a series of hues that are inspired by the underwater world of coral reefs where the explosion of the nuances of coloured plants and tropical fish amaze and surprise. The uniqueness of these glasses lies in their capacity to draw attention of the onlooker, from tumbler they transform themselves in decorative elements that are perfect on the table given their truly ornamental quality.

MARES TUMBLER

art. 3355

MATERIALE / MATERIAL
Pasta di vetro colorato soffiato a bocca e lavorato a mano / Hand-crafted mouth-blown colored glass paste

CAPACITÀ / CAPACITY
310 cc

COLORI / COLOURS

Angel Fish	Tiger Fish
------------	------------

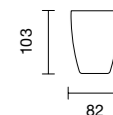

Bolle Tumbler & Bolle Pitcher

*Prodotti in pasta di vetro colorata, Bolle Tumbler e Bolle Pitcher sono caratterizzati da un design sinuoso e da vivaci giochi di luce |
Made of coloured glass paste, Bolle Tumbler and Bolle Pitcher are characterized by a sinuous design that creates lively plays of light*

design by LUCA TRAZZI



IT Innovativi, dal design sinuoso e proposti in sei nuances, i Bolle Tumbler si prestano ad interpretare le tavole più diverse: rigorose, colorate, ricche o minimali. Versatilità e maneggevolezza fanno di questi bicchieri la scelta ideale per servire qualsiasi bevanda, dall'acqua a freschi succhi di frutta, da long drink a cocktail colorati. La Bolle Pitcher è un caraffa originale, ideale per servire soft drink, succhi di frutta, cocktail e aperitivi.

EN Innovative, sinuous in its design and available in six hues, the Bolle Tumbler is apt for interpreting the most diverse tables: elegant, colorful, richly decorated as well as minimalist. Versatility and easy handling make these tumblers the ideal choice for serving everything from water, fresh fruit juices to long drinks and colorful cocktails. The Bolle Pitcher is an original carafe ideal for serving soft drinks, juices, cocktails and fresh drinks.

BOLLE TUMBLER

art. 3350

MATERIALE / MATERIAL
Vetro colorato lavorato a mano /
Colored hand-crafted glass

CAPACITÀ / CAPACITY
340 cc

COLORI / COLOURS
Clear White



Black Transp.

Red



Blue

Orange



105



90

BOLLE PITCHER

art. 1410

MATERIALE / MATERIAL
Vetro lavorato a mano /
Hand-crafted glass

CAPACITÀ / CAPACITY
1200 cc

COLORI / COLOURS
Clear



217



170



Dixie Tumbler

Forme dinamiche e performance di servizio ottimali per la serie Dixie Tumbler in vetro pressato | Dynamic forms for strong performance in service, the Dixie Tumbler series in pressed glass

design by ITALESSE



IT Dixie Tumbler, un bicchiere in vetro pressato trasparente impreziosito da un motivo decorativo in grado di conferire grande luminosità. Disponibile in due formati, dal più capiente Dixie Tumbler di 360 cc al Dixie Tumbler Small con capacità 310 cc. Una straordinaria robustezza assieme all'impilabilità caratterizzano le alte performance nel servizio della collezione. Dixie Tumbler è una scelta ottimale per servire i più svariati tipi di bevande, dai succhi di frutta ai cocktail.

EN Dixie Tumbler, a tumbler in transparent pressed glass is embellished by a decorative motif that gives it intense luminosity. It is available in two different formats, the larger Dixie Tumbler with a capacity of 360 cc and the Dixie Tumbler Small that is 310 cc. An extraordinary robustness together with stackability, assures the strong performance of the collection. Dixie Tumbler is an ideal choice for a wide range of drinks, from juice to cocktails.

DIXIE TUMBLER

art. 0038

MATERIALE / MATERIAL
Vetro / Glass

CAPACITÀ / CAPACITY
360 cc

COLORI / COLOURS
Clear

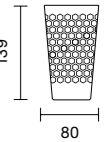

DIXIE TUMBLER SMALL

art. 0039

MATERIALE / MATERIAL
Vetro / Glass

CAPACITÀ / CAPACITY
310 cc

COLORI / COLOURS
Clear

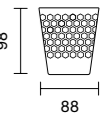

Tonic Glass

Bicchieri impilabili di vetro dalla linea conica, delicata quanto marcatamente definita, adatti in qualsiasi situazione / Conical Tonic Glass tumbler with a delicate and clearly defined design, an ideal choice in all situations

design by CLAESSION KOIVISTO RUNE



IT L'eleganza e la semplicità rendono i bicchieri impilabili Tonic Glass adatti a qualsiasi situazione: una tavola raffinata, un aperitivo informale o proposto più semplicemente da solo. I Tonic Glass sono bicchieri impilabili multifunzionali, adatti a servire tutti i tipi di bevande, dall'acqua ai soft e long drink, dalla birra ai più elaborati cocktail. Tonic Glass Small è la versione piccola di Tonic Glass. Pensato per servire l'acqua in un bicchiere dalle dimensioni contenute, si distingue per fondi stonati e bevante sottile: bicchiere minimal ma di grande carattere. I dettagli tecnici ne fanno il bicchiere ideale per servire anche liquori e distillati e suggeriscono un nuovo modo di gustare il vino, decisamente più contemporaneo.

EN The elegance and simplicity of conical Tonic Glass make it the ideal choice for all situations: a refined table, an informal aperitif or presented alone in all its deliberate simplicity. Stackable and multifunctional, Tonic Glass is ideal for serving all types of drinks, ranging from water to soft and long drinks, beer and elaborate cocktails. Tonic Glass Small is the small version of Tonic Glass. Designed to serve water in a glass of a smaller size, it is characterized by a rounded base and a delicate rim making it minimal yet full of character. The technical details make it the ideal glass for serving liqueurs and spirits, as well as a contemporary and suggestive way to enjoy wine.

TONIC GLASS

art. 3318

MATERIALE / MATERIAL
Vetro / Glass

CAPACITÀ / CAPACITY
400 cc

COLORI / COLOURS
Clear



TONIC GLASS SMALL

art. 3317

MATERIALE / MATERIAL
Vetro / Glass

CAPACITÀ / CAPACITY
290 cc

COLORI / COLOURS
Clear

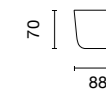

Sfera

Bicchieri multiuso in vetro con base in gomma colorata utile alla gestione dell'inclinazione per un servizio fantasioso / Multi-purpose glass with a colored rubber base on which to tilt the glass for a creative service

design by MINEDIVINE



IT Bicchiere multifunzionale di forma sferica e imboccatura ampia per distillati e liquori che permette un comodo utilizzo anche per finger food, dolci al cucchiaio e piccole prelibatezze cucinate direttamente nel forno. Sfera è dotato di una base piatta che consente di appoggiarlo con sicurezza sul piano. L'anello in gomma soffice, permette di posizionarlo secondo l'inclinazione preferita.

EN A multifunctional glass with a spherical shape and a wide mouth for distillates and liqueurs, perfect also for innovative finger food presentation, desserts and small delicacies cooked directly in the oven. Sfera has a flat base so it can be placed safely on flat surfaces. Its silicone base, allows for placing of the glass at an angle as preferred.

SFERA

art. 3330

MATERIALE / MATERIAL
Vetro borosilicato soffiato a bocca, lavorato a mano e gomma soffice colorata base / Mouth-blown hand-crafted borosilicate glass and soft-coloured rubber base

CAPACITÀ / CAPACITY
580 cc

COLORI / COLOURS
Clear



BASE: White

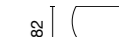

82



114



80



Go Go

Bicchieri da liquore e distillati caratterizzati da coppe ampie che amplificano le potenzialità degustative, disponibili in due varianti | Liqueur and spirits glasses characterized by wide bowls that heighten the tasting experience, available in two variants

design by ITALESSE

IT La sinuosità delle linee di Go-Go, tumbler dalle proporzioni e dalla capacità generosa, ritrova gli stessi equilibri anche nella versione small. Capaci di esaltare i profumi del distillato e di far percepire profondamente gli aromi grazie all'ampia coppa che ne amplifica e sprigiona le potenzialità degustative. Nati per degustare anche liquori dolci, limoncelli e amari, entrambi i calici presentano una capacità di 4 cl nella base.

EN The sinuosity of Go-Go, a large-sized tumbler, is also balanced in its small version. Capable to enhance the flavor of distillates and to help aromas be fully perceived thanks to its large cup, which amplifies and enhances tastes. The capacity of the base of both glasses, which have been designed to also taste sweet liquors, limoncello and bitters, is 4 cl.

GO-GO

art. 3319

MATERIALE / MATERIAL
Vetro cristallino soffiato in automatico
in assenza di piombo / Crystalline
automatic blown glass with no lead

CAPACITÀ / CAPACITY
580 cc

COLORI / COLOURS
Clear

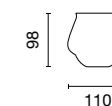

GO-GO SMALL

art. 3328

MATERIALE / MATERIAL
Vetro cristallino soffiato in automatico
in assenza di piombo / Crystalline
automatic blown glass with no lead

CAPACITÀ / CAPACITY
320 cc

COLORI / COLOURS
Clear

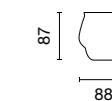

Premium Collection

Bicchieri polifunzionali in vetro cristallino perfetti per il mondo mixology | Multifunctional glasses made of crystalline glass, perfect for the world of mixology

design by ITALESSE

IT La linea premium di Italesse è specificamente studiata per soddisfare tutte le esigenze di servizio legate al mondo mixology: long e soft drinks, cocktails, whisky, martini etc. e diventano l'assortimento perfetto per i contesti bar e ristorante. Profili morbidi e trasparenza di luce grazie al materiale vetro cristallino per una linea sobria e raffinata formata da due tumbler bassi, due tumbler allungati, una coppa martini e un mini tumbler shot. Questi prodotti sono attentamente studiati nelle capacità e altamente polifunzionali. Dotati di un fondo spesso che garantisce la massima resistenza ed eleganza.

EN Italesse premium line is specifically designed to meet all service requirements linked to the mixology world: long and soft drinks, cocktails, whiskeys, martinis. They are the perfect range for bars / restaurants. Soft shapes and brilliance thanks to the crystal clear glass for a sober and refined line consisting of two low tumblers, two tall tumblers, a martini glass and a mini tumbler shot. The capacity of these items is carefully studied and multifunctional. They come with a thick base, which guarantees top resistance and elegance.



PREMIUM MARTINI

art. 0034

MATERIALE / MATERIAL
Vetro cristallino soffiato in automatico
in assenza di piombo / Crystalline
automatic blown glass with no lead

CAPACITÀ / CAPACITY
240 cc

COLORI / COLOURS
Clear

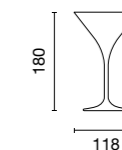

PREMIUM TUMBLER LARGE

art. 0030

MATERIALE / MATERIAL
Vetro cristallino soffiato in automatico
in assenza di piombo / Crystalline
automatic blown glass with no lead

CAPACITÀ / CAPACITY
465 cc

COLORI / COLOURS
Clear

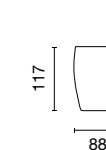

PREMIUM TUMBLER

art. 0025

MATERIALE / MATERIAL
Vetro cristallino soffiato in automatico
in assenza di piombo / Crystalline
automatic blown glass with no lead

CAPACITÀ / CAPACITY
345 cc

COLORI / COLOURS
Clear

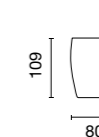

PREMIUM HI-BALL LARGE

art. 0033

MATERIALE / MATERIAL
Vetro cristallino soffiato in automatico
in assenza di piombo / Crystalline
automatic blown glass with no lead

CAPACITÀ / CAPACITY
435 cc

COLORI / COLOURS
Clear

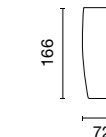

PREMIUM HI-BALL

art. 0032

MATERIALE / MATERIAL
Vetro cristallino soffiato in automatico
in assenza di piombo / Crystalline
automatic blown glass with no lead

CAPACITÀ / CAPACITY
310 cc

COLORI / COLOURS
Clear

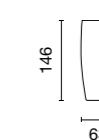

PREMIUM SHOT

art. 0031

MATERIALE / MATERIAL
Vetro cristallino soffiato in automatico
in assenza di piombo / Crystalline
automatic blown glass with no lead

CAPACITÀ / CAPACITY
72 cc

COLORI / COLOURS
Clear

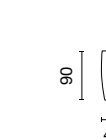

Beach Collection

Una proposta di calici e bicchieri perfetti in ambienti outdoor per un servizio glamour in piena sicurezza | A collection of stemware and tumblers perfect for outdoor environments, for glamorous service in complete safety

design by ITALESSE



IT Funzionale, infrangibile, divertente, la linea Beach ripropone i calici, i flûte, i tumbler Italesse in versione outdoor, pratici e sicuri perché assolutamente indistruttibili. Perfetti per il mondo outdoor (piscine, spiagge, club), la linea è realizzata in policarbonato, materiale plastico nobile declinato in un'ampia gamma di prodotti, dal tumbler per acqua e soft drink, al calice per vini bianchi e rossi, dal flûte da champagne alla più glamour coppa martini.

EN Functional, unbreakable, fun, the Beach line proposes Italesse stem glasses, flutes, tumblers in their practical and safe thanks to their unbreakable qualities. Perfect for outdoor settings (pools, spas, beaches, clubs), the line is made of polycarbonate, a premium quality plastic material for a wide range of products, from the tumbler for water and soft-drinks, the stem glass for red and white wines to the champagne flute and the glamorous Martini glass.



MARTINI BEACH

art. 3945

MATERIALE / MATERIAL
Policrystal®CAPACITÀ / CAPACITY
270 ccCOLORI / COLOURS
Clear

VERTICAL BEACH

art. 3930

MATERIALE / MATERIAL
Policrystal®CAPACITÀ / CAPACITY
330 ccCOLORI / COLOURS
Clear

PRIVÉ BEACH

art. 3920

MATERIALE / MATERIAL
Policrystal®CAPACITÀ / CAPACITY
130 ccCOLORI / COLOURS
Clear White

PRIVÉ GRAND CRU BEACH

art. 3921

MATERIALE / MATERIAL
Policrystal®CAPACITÀ / CAPACITY
195 ccCOLORI / COLOURS
Clear White

BREW BEACH 40

art. 3917

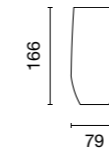
MATERIALE / MATERIAL
Policrystal®CAPACITÀ / CAPACITY
540 ccCOLORI / COLOURS
Clear

BREW BEACH 33

art. 3916

MATERIALE / MATERIAL
Policrystal®CAPACITÀ / CAPACITY
450 ccCOLORI / COLOURS
Clear

VERTICAL PARTY BEACH

art. 3935

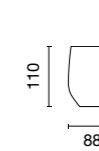
MATERIALE / MATERIAL
Policrystal®CAPACITÀ / CAPACITY
420 ccCOLORI / COLOURS
Clear White**Red****Blue**

MOONLIGHT BEACH

art. 3931

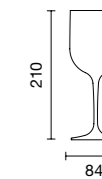
MATERIALE / MATERIAL
Policrystal®CAPACITÀ / CAPACITY
410 ccCOLORI / COLOURS
Clear White

SUNLIGHT BEACH

art. 3922

MATERIALE / MATERIAL
Policrystal®CAPACITÀ / CAPACITY
330 ccCOLORI / COLOURS
Clear White

Air Beach Collection

Calici realizzati in materiale plastico Tritan™, ideali per servire vini e aperitivi in ambienti outdoor | Plastic glasses made in Tritan™ ideal for tasting wine and aperitifs in an outdoor context

design by ITALESSE

IT Dalle forme pure e classiche, questa linea di calici in materiale plastico Tritan™ è composta dai modelli Air Beach G&T, Air Beach Wine, Air Beach Flute 20; è estremamente versatile e indicata per il servizio professionale. La tecnica di soffiatura permette una fedele emulazione delle forme tradizionali dei calici da vino in vetro. Gli spessori sono meno importanti, il che li rende leggerissimi e maneggevoli al tatto. Gli Air Beach sono ideali per una degustazione o grande manifestazione outdoor, per i locali sulle spiagge e con spazi all'aperto, gli hotel con servizio bar in piscina o in spiaggia. Tutti momenti e luoghi dove l'impiego del vetro può risultare poco sicuro.

EN Classical, pure forms that carry the essence of traditional glasses this Tritan™ plastic stemware is highly versatile. Composed of the models Air Beach G&T, Air Beach Wine and Air Beach Flute 20; this collection lends itself perfectly to professional service. Made using machine blown techniques this stemware is extraordinarily light rendering it incredibly elegant and easy-to-handle and with optimum transparency. The Air Beach is a perfect addition to any outdoor tasting or exhibition, beach and pool service and for al fresco dining, all situations in which the use of glass would be unsafe.



AIR BEACH G&T

art. 0048

MATERIALE / MATERIAL
Tritan™ soffiato in automatico /
Automatic blown Tritan™

CAPACITÀ / CAPACITY
700 cc

COLORI / COLOURS
Clear

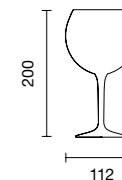

AIR BEACH WINE

art. 0050

MATERIALE / MATERIAL
Tritan™ soffiato in automatico /
Automatic blown Tritan™

CAPACITÀ / CAPACITY
475 cc

COLORI / COLOURS
Clear

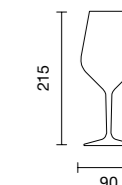

AIR BEACH FLÛTE 20

art. 0063

MATERIALE / MATERIAL
Tritan™ soffiato in automatico /
Automatic blown Tritan™

CAPACITÀ / CAPACITY
200 cc

COLORI / COLOURS
Clear

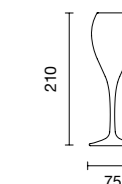

Bolle Beach Tumbler

Un bicchiere in policarbonato con una superficie ricca di bolle in rilievo, Bolle Beach Tumbler dona un tocco vivace e divertente alla collezione | A polycarbonate glass with a surface with embossed bubbles Bolle Beach Tumbler gives the collection a fun and lively touch

design by LUCA TRAZZI



IT Un design emozionale ed originale caratterizza questo bicchiere. Adatto a servire acqua, freschi succhi di frutta o aperitivi alcolici, Bolle Beach Tumbler è ideale per essere utilizzato in ambienti professionali in quanto funzionale, impilabile e resistente nel servizio e si inserisce perfettamente anche in moderni ambienti casa sia indoor che outdoor.

EN An original and emotional design characterizes this tumbler. Suitable for serving water, fresh fruit juices or alcohol based drinks, Bolle Beach Tumbler is ideal in professional environments for its functionality, stackability and durability yet lends itself perfectly to use in the modern home, both indoors and outdoors.



BOLLE BEACH TUMBLER

art. 3941

MATERIALE / MATERIAL
Policrystal®

CAPACITÀ / CAPACITY
350 cc

COLORI / COLOURS
Clear

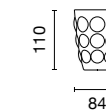

Fresnel Collection

Prende il nome dall'omonima lente la linea di calici Fresnel Beach, ispirata alle tradizionali coppe muranesi / Fresnel Beach, the line of glasses that draws inspiration for traditional Murano glasses

design by LUCA NICHETTO



IT Realizzata in materiale plastico resistente quanto duttile, Fresnel presenta una decorazione tridimensionale della superficie che garantisce la resistenza ai graffi e ne amplifica i riflessi. Accattivante sul piano estetico, leggera, antigraffio e colorata, la nuova linea composta da un calice vino, un flûte da champagne e un tumbler, per i ristoranti e club più glamour, proponendo un nuovo stile per serate all'insegna di meravigliosi giochi di luce.

EN Made of resistant and supple plastic, Fresnel features a three-dimensional surface decoration for enhanced reflections and guarantees scratch-proof properties. The Fresnel line is charming, lightweight, non-scratch as well as colorful and consists of a wine glass, a champagne flûte and a tumbler. The line gives a new edge to glamorous restaurants and clubs proposing a new style for nights with wonderful plays of light.



FRESNEL WINE

art. 3946

MATERIALE / MATERIAL
Policrystal®

CAPACITÀ / CAPACITY
330 cc

COLORI / COLOURS
Clear



FRESNEL FLÛTE

art. 3947

MATERIALE / MATERIAL
Policrystal®

CAPACITÀ / CAPACITY
200 cc

COLORI / COLOURS
Clear



FRESNEL PARTY

art. 3948

MATERIALE / MATERIAL
Policrystal®

CAPACITÀ / CAPACITY
360 cc

COLORI / COLOURS
Clear

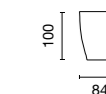

Tonic Beach

Bicchieri in policarbonato impilabili, disponibili in due capacità e perfetti per servire qualsiasi tipo di bibita | Stackable polycarbonate glasses, available in two different capacities that are ideal for serving all kinds of drinks

design by CLAESSION KOIVISTO RUNE

IT Tonic beach, realizzato in Policrystal® infrangibile e lavabile in lavastoviglie, è stato pensato per servire long e soft drinks, come ogni tipo di bibita, dalla birra all'acqua. La forma conica lo rende perfettamente impilabile e dunque funzionale per l'ottimizzazione degli spazi in ambienti bar/club. Disponibile in due dimensioni (350 cc e 500 cc).

EN Tonic beach, made of unbreakable, dishwasher-safe, Policrystal® material, has been designed to serve long and soft drinks, and all types of drinks, from beer to water. Thanks to its conical shape, it is perfectly stackable, therefore functional for space optimization in bars/clubs. It comes in two sizes (350 cc and 500 cc).



TONIC BEACH LARGE

art. 3903

MATERIALE / MATERIAL
Policrystal®

CAPACITÀ / CAPACITY
500 cc

COLORI / COLOURS
White Frost

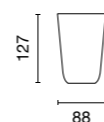

TONIC BEACH MEDIUM

art. 3902

MATERIALE / MATERIAL
Policrystal®

CAPACITÀ / CAPACITY
350 cc

COLORI / COLOURS
White Frost

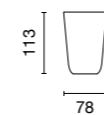

78



Pachà Beach Light

Bicchieri in polipropilene opalescente dalle caratteristiche ottimali per la preparazione di pestati e cocktail | Tumblers in opalescent polypropylene with optimum characteristics for the preparation of drinks made with crushed ice and cocktails

design by ITALESSE

IT Tumbler in polipropilene opalescente infrangibile disponibile nelle due varianti Large e Medium. Fondo spesso e diametro della bocca studiato per interagire con lo shaker rendono questo bicchiere ideale per la preparazione di pestati e cocktail di ogni genere. Bestseller nei club di tutto il mondo per estetica e praticità.

EN Unbreakable, opalescent polypropylene tumbler available in two variants, Large and Medium. The thick bottom and the mouth diameter designed to fit the shaker make this glass the ideal solution to prepare all kinds of mashed cocktails and cocktails. Because of its look and convenience, it is a bestseller item in clubs all over the world.



PACHÀ BEACH LIGHT LARGE

art. 3901

MATERIALE / MATERIAL
Polipropilene / Polypropylene

CAPACITÀ / CAPACITY
500 cc

COLORI / COLOURS
White Frost

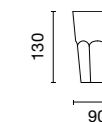

90

PACHÀ BEACH LIGHT MEDIUM

art. 3900

MATERIALE / MATERIAL
Polipropilene / Polypropylene

CAPACITÀ / CAPACITY
400 cc

COLORI / COLOURS
White Frost

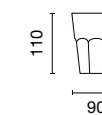

90

Vas & Organica

*Caraffe ergonomiche in vetro soffiato a bocca, dalla forte personalità |
Ergonomic carafes in mouth-blown glass, with strong personality*

design by TODD BRACHER and MINEDIVINE



IT Caraffe in vetro soffiato a bocca e lavorato a mano dalle linee sinuose ed eleganti. Vas e Organica sono caraffe ideali per mantenere e servire acqua, succhi di frutta, soft drink e vini alla spina.

EN Mouth-blown, hand-crafted glass carafes with elegant and sinuous lines. The Vas and Organica carafes are ideal for serving water, fruit juice, soft drinks and draught wines.



VAS

art. 1425

MATERIALE / MATERIAL
Vetro soffiato a bocca e lavorato a mano, materiale plastico *tappo* / Mouth-blown and hand-crafted glass, plastic *stopper*

CAPACITÀ / CAPACITY
1000 cc

COLORI / COLOURS
Clear

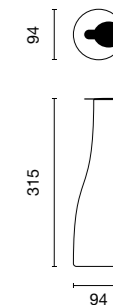

ORGANICA 1000

art. 1400

MATERIALE / MATERIAL
Vetro soffiato a bocca e lavorato a mano in assenza di piombo / Mouth-blown and hand-crafted glass with no lead

CAPACITÀ / CAPACITY
1000 cc

COLORI / COLOURS
Clear

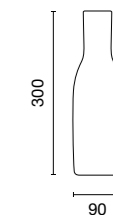

ORGANICA 500

art. 1399

MATERIALE / MATERIAL
Vetro soffiato a bocca e lavorato a mano in assenza di piombo / Mouth-blown and hand-crafted glass with no lead

CAPACITÀ / CAPACITY
500 cc

COLORI / COLOURS
Clear

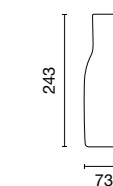

ORGANICA 250

art. 1398

MATERIALE / MATERIAL
Vetro soffiato a bocca e lavorato a mano in assenza di piombo / Mouth-blown and hand-crafted glass with no lead

CAPACITÀ / CAPACITY
250 cc

COLORI / COLOURS
Clear

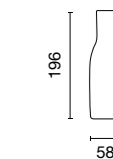

Vinocchio

Decanter in vetro soffiato dalle caratteristiche altamente professionali e dallo stile contemporaneo | Mouth-blown glass decanter with highly professional features and a contemporary style

design by FEDERICO VENIER

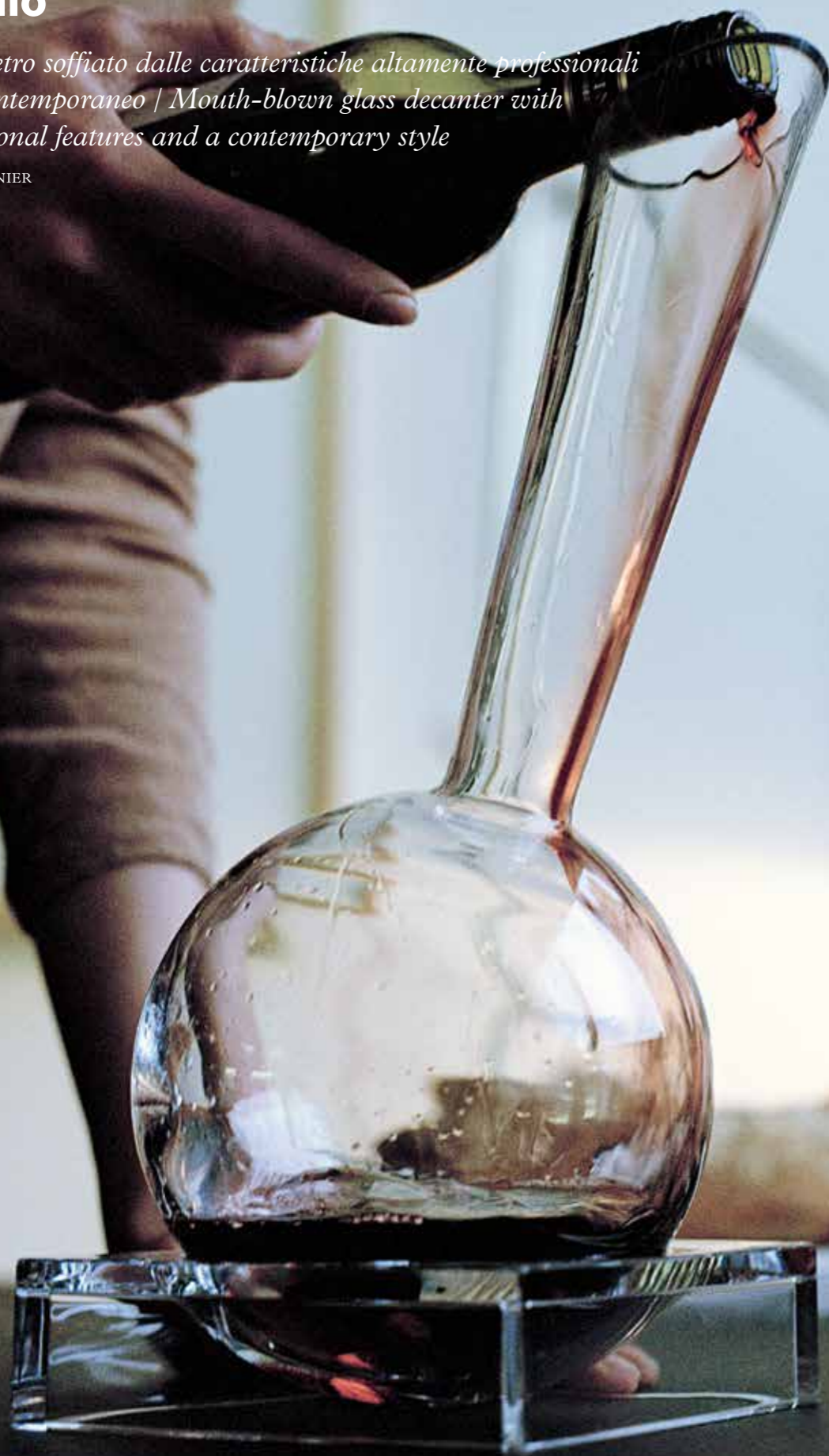

IT Vinocchio deve ironicamente il suo nome e le sue linee al naso e al volto di Pinocchio. Concepito per ossigenare i vini rossi, questo decanter in vetro soffiato è caratterizzato da uno stile vivace e innovativo in tutti i dettagli: imboccatura con taglio obliquo, impugnatura ergonomica, bilanciamento ottimale, piquère profonda, base in materiale acrilico. Vinocchio viene completato da Drop-Down, un pratico ed elegante sostegno per l'asciugatura del decanter.

EN Vinocchio is a play on the name and shape of Pinocchio's nose and face. Designed to oxygenate red wines, this blown glass decanter is characterized by a brilliant and innovative style in all details: slanted mouth, ergonomic handling, excellent balance, deep piquère and acrylic base. Vinocchio is completed by Drop-Down, a practical and refined support for perfect drying of the decanter.

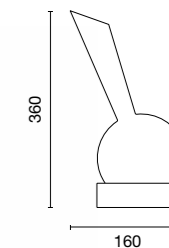

VINOCCHIO

art. 1335

MATERIALE / MATERIAL
Vetro soffiato a bocca, lavorato a mano / decanter e acrilico base /
Mouth-blown hand-crafted glass / decanter and acrylic base

CAPACITÀ / CAPACITY
1500 cc

COLORI / COLOURS

Clear Black



Orange



Black



Silver



VINOCCHIO DROPDOWN

art. 6043

MATERIALE / MATERIAL
Acciaio inossidabile supporto e **gomma soffice** vaschetta /
Stainless steel holder and **soft rubber** tray

COLORI / COLOURS

Clear

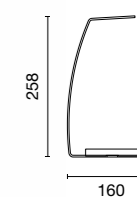
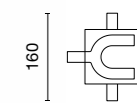

Alavin

Decanter caratterizzato da base basculante che lo rende capace di ruotare sulla tavola per ossigenare il vino oppure può essere appoggiato sulla base portaghiaccio per mantenere la temperatura ottimale del contenuto / Characterized by a swivelling base, Alavin rotates on tabletops for the decanting of fine wines or alternatively can be placed on the ice container to keep their contents chilled

design by FEDERICO VENIER



IT Caratterizzato da una base basculante, Alavin è un decanter 'refrigeratore' che può essere lasciato libero di ruotare sulla tavola per decantare vini rossi invecchiati o essere appoggiato sulla base porta ghiaccio per mantenere il vino alla corretta temperatura. Molte volte, infatti, i vini rossi vengono serviti ad una temperatura troppo elevata rendendo inadatta la degustazione. Alavin è perfetto per servire anche freschi succhi di frutta o acqua nelle breakfast room degli hotel. Dotato di un tappo in acrilico trasparente che permette il servizio anche in banchetti all'aperto e di un comodo accessorio che consente di capovolgere la caraffa per una corretta asciugatura: Alavin drop-down.



EN Characterized by a balancing base, Alavin is a "refrigerator" decanter, which can be let free to spin on the table to decant aged red wines or rest on the ice holding base to maintain wine at the right temperature. Many times, in fact, red wines are served at too high a temperature, which spoils their taste. Alavin is perfect to also serve fruit juices or water in hotel breakfast rooms. It comes with a clear acrylic stopper, which makes it suitable also for service in outdoor banquets, and a convenient accessory that helps the jug to be turned upside down for proper drying: Alavin drop-down.



SET ALAVIN

art. 1345

MATERIALE / MATERIAL
Vetro soffiato a bocca,
lavorato a mano decanter
e acrilico-silicone base /
Mouth-blown hand-crafted
glass decanter
and acrylic-silicone base

CAPACITÀ / CAPACITY
1700 cc

COLORI / COLOURS
Clear **Black**



Violet

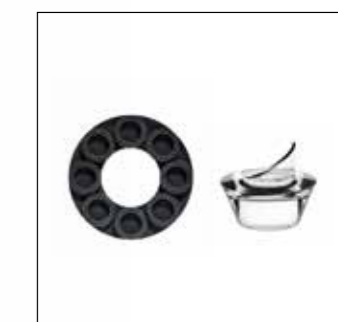
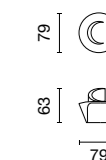
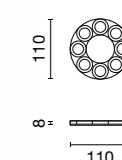
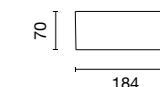
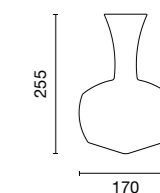

Plaza Bucket & Bowl

Un design all'avanguardia con una superficie sfaccettata che richiama il classico taglio del cristallo, il secchiello e la spumantiera Plaza catturano l'attenzione con un brillante gioco di luci | A pioneering design with a textured surface that evokes traditional cut crystal, the Plaza Bucket and Bowl draw your attention with its brilliant plays of light

design by LUCA TRAZZI



IT Il secchiello e la spumantiera Plaza sono estremamente luminosi grazie alla loro realizzazione in materiali acrilici di qualità cristallina. L'effetto scintillante è accentuato dall'aggiunta di una base LED ricaricabile opzionale che illumina il ghiaccio e le bottiglie contenute. Plaza è perfettamente impilabile.

EN The Plaza Bucket and Bowl are extremely luminous and are made with crystalline quality acrylic materials. The scintillating effect is heightened with the addition of an optional, rechargeable LED base which illuminates the ice and the bottles it contains. Plaza is fully stackable.



Disponibile con base LED /
Available with LED base

PLAZA BUCKET

art. 1584

MATERIALE / MATERIAL
Acrilico / Acrylic

COLORI / COLOURS
Clear

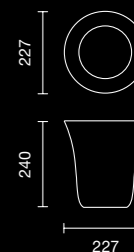

PLAZA BOWL

art. 1616

MATERIALE / MATERIAL
Acrilico / Acrylic

COLORI / COLOURS
Clear

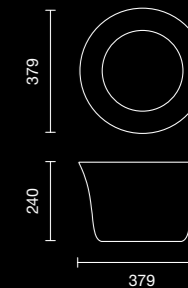

Vela Bucket & Bowl

Un secchiello ed una spumantiera dalla forma armonica e innovativa, esaltata ancor di più dalla base luminosa che mette in risalto la lucentezza dell'acrilico e le bottiglie in esso contenute / A bucket and a bowl with harmonious and innovative shapes. The led bases enhance the beauty of these items further and highlight the brilliance of the acrylic and the bottles they contain

design by ITALESSE



IT Il secchiello e la spumantiera Vela posseggono un design curvo che richiama l'eleganza di una vela ed un bordo a taglio diamantato che valorizza la luminosità e gli spessori. Realizzati in materiale ad alta trasparenza, i Vela di Italesse possono essere illuminati grazie a due base LED ricaricabili ed utilizzati come supporto espositivo. La forma innovativa, con la schiena a ventaglio, attira l'attenzione ed esalta il valore delle bottiglie in essi contenute, l'ergonomia li rende semplici da utilizzare.

EN Designed with elegant curves the Vela Bucket and Bowl echo the forms of a wind-filled sail, a diamond-cut edge heightens the luminosity of these containers. Manufactured in highly transparent material, Vela objects can furthermore be illuminated with a rechargeable LED base and used as bottle-glorifiers. Their unique shape with their fan-shaped back capture the onlooker's attention and serve to highlight the value of the bottles contained as well as giving them a highly ergonomic design.



Disponibile con base LED /
Available with LED base



VELA BUCKET

art. 1583

MATERIALE / MATERIAL
Acrilico / AcrylicCOLORI / COLOURS
Clear

White

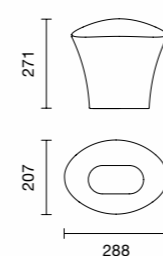

VELA BOWL

art. 1615

MATERIALE / MATERIAL
Acrilico / AcrylicCOLORI / COLOURS
Clear

White



Silver

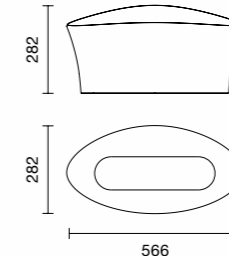

VELA BUCKET ROUND

art. 1589

MATERIALE / MATERIAL
Acrilico / AcrylicCOLORI / COLOURS
Clear

White



Black

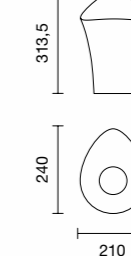

VELA BOWL ROUND

art. 1617

MATERIALE / MATERIAL
Acrilico / AcrylicCOLORI / COLOURS
Clear

White



Black

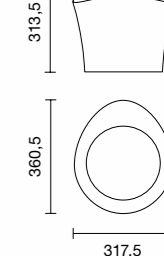

Bolle Bucket & Bowl

Vere icone della collezione Italesse, il secchiello e la spumantiera Bolle sono interamente ricoperte da sfere di materiale acrilico trasparente, che le rendono luminose ed eleganti | Icons in Italesse's collection, Bolle Bucket and Bowl are completely covered with clear acrylic spheres, which make them extremely bright and elegant

design by LUCA TRAZZI



IT Esaltata dai tanti e continui giochi di luce, la collezione Bolle si caratterizza per la leggerezza della luminosità, il suo stile e la sua raffinatezza. Adatta ad ambienti indoor e outdoor e a ogni tipo di tavola.

EN Enhanced by uninterrupted plays of light, the Bolle collection is characterized by its style, luminosity and elegance, which makes it suitable for indoor and outdoor environments and all types of tables.



BOLLE BOWL

art. 1586
art. 1587 - Bolle Bucket Pro*

MATERIALE / MATERIAL
Acrilico / Acrylic

COLORI / COLOURS
Clear

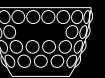
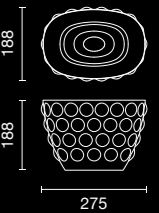

*Bolle Bucket Pro
personalizzabile /
customizable

BOLLE BUCKET

art. 1612
art. 1613 - Bolle Bowl Pro*

MATERIALE / MATERIAL
Acrilico / Acrylic

COLORI / COLOURS
Clear

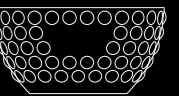
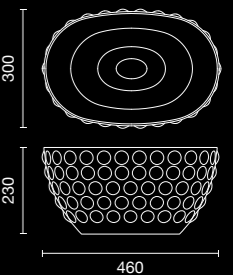

*Bolle Bowl Pro
personalizzabile /
customizable

Solomon Bucket

Con Solomon Italesse rinnova l'immagine del secchiello e porta in tavola un prodotto ispirato alla sinuosità del Guggenheim di New York. Il secchiello infatti può essere arricchito con una base luminosa LED che rifrange la luce attraverso il materiale plastico | Italesse renews the image of the traditional ice-bucket with Solomon presenting an iconic item that takes its inspiration from the sinuous Guggenheim Museum of New York. The LED lighting of the optional base refracts and illuminates the plastic material

design by CARLOS TÍSCAR



IT Solomon, un singolare secchiello portagiaccio pensato con una chiara idea dell'utilizzo finale ed un'estetica accattivante. Realizzato da Tiscar riesce, con il suo design, a donare movimento all'oggetto e grazie alla sua superficie permette una presa sicura ed un alto grado di maneggevolezza. Solomon, grazie alle sue proporzioni generose e alla sua immagine altamente iconica e riconoscibile, è ideale per rendere davvero unici ambienti bar o club. Il secchiello infatti può essere arricchito con una base luminosa LED che rifrange la luce attraverso il materiale plastico, illuminando aperitivi intimi e grandi serate glamour.

EN Solomon, a singular ice-bucket conceived with a clear underlying functional concept and a captivating aesthetic. Made in the form of a spiral that turns on itself Tiscar's design awards the piece movement and moreover creates a ridged surface that promotes grip and easy handling. Thanks to its large, practical size, Solomon is the perfect ally to make bars or clubs truly unique with its highly iconic and recognizable image. The LED lighting of the optional base refracts through the plastic material and illuminates the most secluded corners of any venue for intimate aperitifs, adding a touch of glamour in exclusive clubs.



Disponibile con base LED /
Available with LED base

SOLOMON BUCKET

art. 1585

MATERIALE / MATERIAL
Acrilico / Acrylic

COLORI / COLOURS
Clear White

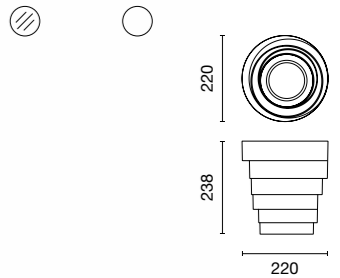

Pagoda Bucket & Gran Pagoda Bowl

Un secchiello ed una spumantiera in materiale acrilico dalle forme squadrate, decise e perfettamente impilabili | An acrylic Bucket and Bowl with bold, square shapes that are perfectly stackable

design by FEDERICO VENIER

IT La spumantiera Gran Pagoda è in grado di contenere e rinfrescare fino a 6 bottiglie di vino o spumante. Perfettamente impilabile e con maniglia incassata che evita la fuoriuscita di ghiaccio e acqua, è ideale sui banconi dei bar, nei party e in occasione di feste anche a casa. Pagoda Bucket è studiato per rinfrescare e trasportare comodamente una bottiglia, anche usando una sola mano.

EN The Gran Pagoda Bowl is suitable for up to 6 wine or champagne bottles. Fully stackable, its indented handle prevents the spillage of ice and water. A multi-purpose container that is a must-have for parties or bar counters. The Pagoda Bucket is designed to cool and comfortably carry a bottle even with just one hand.

PAGODA BUCKET

art. 1545

MATERIALE / MATERIAL
Acrilico / Acrylic

COLORI / COLOURS
Clear Black

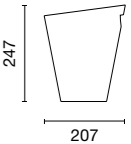

PAGODA BUCKET MIRROR

art. 1700

MATERIALE / MATERIAL
Inox

COLORI / COLOURS
Inox

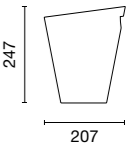

GRAN PAGODA BOWL

art. 1610

MATERIALE / MATERIAL
Acrilico / Acrylic

COLORI / COLOURS
Clear Black

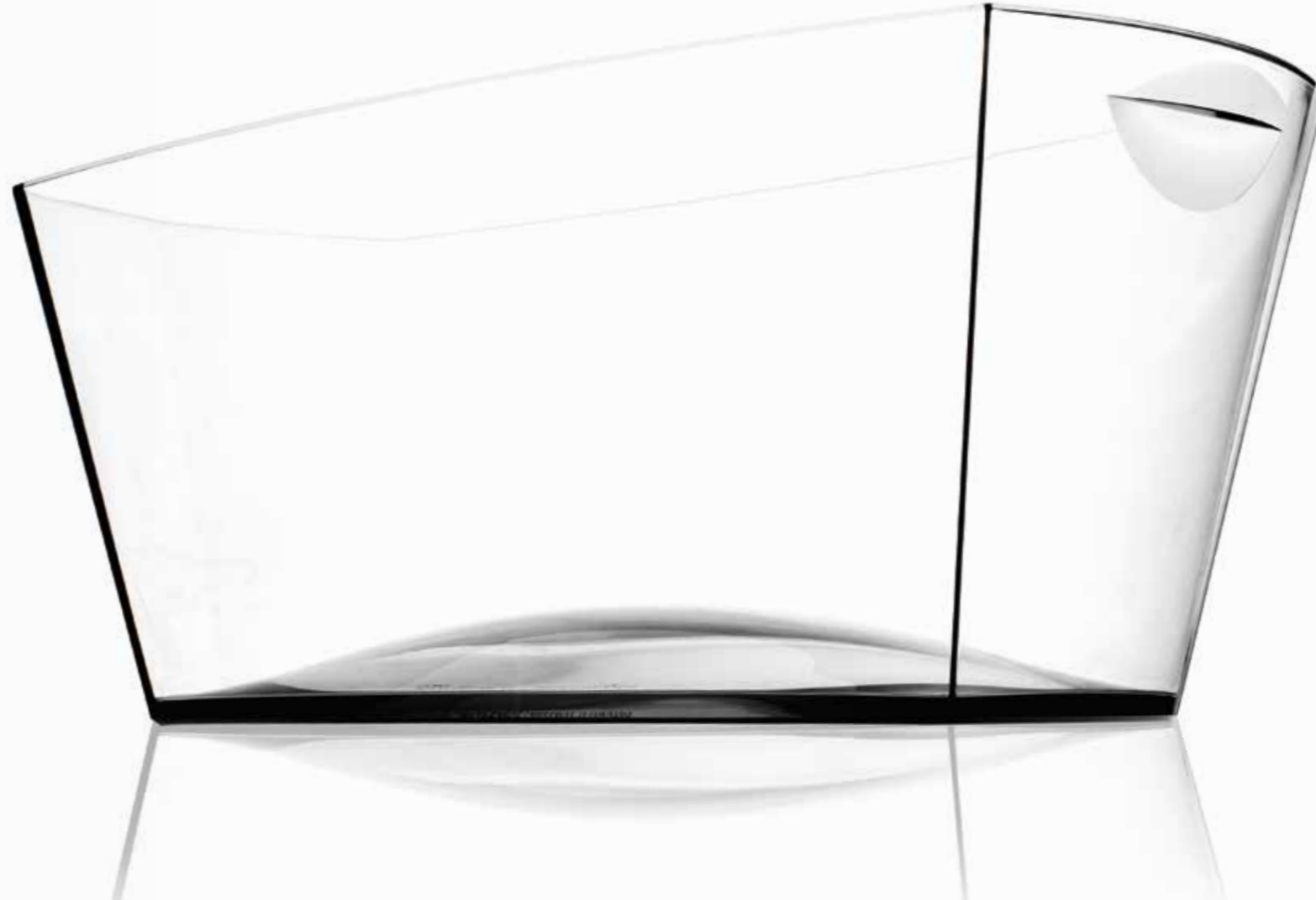
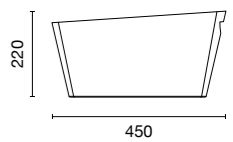
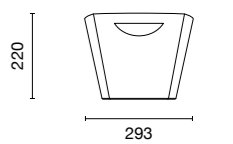

Tonic Ice Bucket & Bowl

Tonic Ice Bucket e Tonic Ice Bowl riprendono le linee coniche del bicchiere Tonic della collezione Italesse e reinventano lo stile di uno strumento ideale per il mondo della notte | Tonic Ice Bucket and Tonic Ice Bowl take the cone shaped lines of the Tonic glass of the Italesse collection and reinvent the style for an ideal tool for the night world

design by CLAESSION KOIVISTO RUNE



IT Un secchiello ed una spumantiera dalle linee semplici ma distintive. Dotati di una base luminosa interna, Tonic Ice Bucket & Bowl permettono di illuminare le bottiglie in essi contenute grazie all'estrema trasparenza del materiale acrilico di cui si compongono.

EN An ice bucket and Champagne bowl with simple, yet distinctive lines. An optional LED base illuminates the bottles they contain by virtue of the extreme transparency of the acrylic material of which the Bucket and Bowl are made.



Disponibile con base LED / Available with LED base

TONIC ICE BUCKET

art. 1588

MATERIALE / MATERIAL
Acrilico / Acrylic

COLORI / COLOURS
Clear

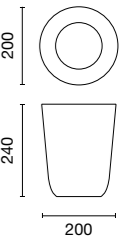

TONIC ICE BOWL

art. 1614

MATERIALE / MATERIAL
Acrilico / Acrylic

COLORI / COLOURS
Clear

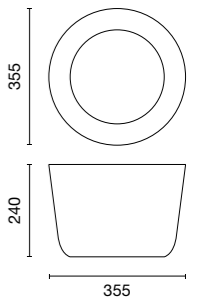

Easy Buckets & Bowls

Easy è la linea di secchielli e spumantiere dall'eleganza raffinata e formale | Easy is the refined, elegant and formal line of ice Buckets and Champagne Bowls

design by FEDERICO VENIER

IT I secchielli e le spumantiere Easy sono caratterizzati da linee inclinate ed opposte del bordo superiore e del fondo. Questo particolare valorizza la bottiglia come se fosse posata su un supporto espositivo. Il loro bordo esterno a “taglio diamantato” ne valorizza la luminosità e gli spessori utilizzati. La spumantiere di questi modelli è studiata per cinque bottiglie di vino, quattro da Champagne, mentre il secchiello è ideale per una sola bottiglia per i modelli Square e Round e per due bottiglie per il modello Oval.

EN The collection of Easy Buckets and Bowls are characterized by slanted and opposed lines of the top edge and the base: this detail enhances the visibility of the bottle as if it were laid on a display support. Their top “diamond-shaped cut” edge enhances their brightness and thickness. The Champagne Bowls of these models are designed to contain up to five wine bottles or four champagne bottles, while the Bucket is ideal for a single bottle in the Square and Round models and up to two bottles in the Oval model.

EASY BUCKET OVAL

art. 1580

MATERIALE / MATERIAL
Acrilico / Acrylic

COLORI / COLOURS
Clear



White

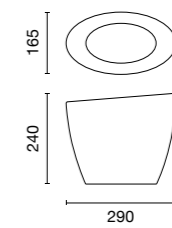

EASY BOWL OVAL

art. 1609

MATERIALE / MATERIAL
Acrilico / Acrylic

COLORI / COLOURS
Clear



White

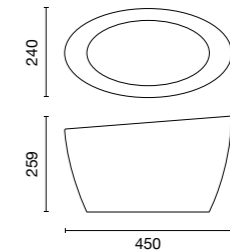

EASY BUCKET SQUARE

art. 1578

MATERIALE / MATERIAL
Acrilico / Acrylic

COLORI / COLOURS
Clear



Black

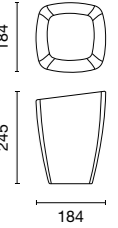

EASY BOWL SQUARE

art. 1607

MATERIALE / MATERIAL
Acrilico / Acrylic

COLORI / COLOURS
Clear



Black

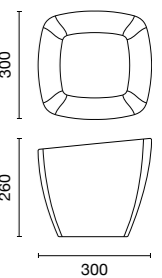

EASY BUCKET ROUND

art. 1574

MATERIALE / MATERIAL
Acrilico / Acrylic

COLORI / COLOURS
Clear



Black

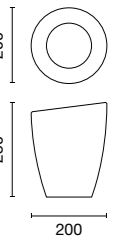

EASY BOWL ROUND

art. 1605

MATERIALE / MATERIAL
Acrilico / Acrylic

COLORI / COLOURS
Clear



Black

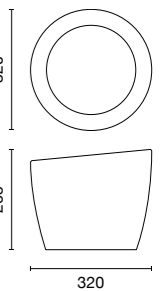

Bongo Bucket & Bowl

Caratterizzati da linee morbide e con una forma ellittica, il secchiello e la spumantiera Bongo sono oggetti dotati di una presenza forte e dal richiamo irresistibile al tavolo dei drink. Bongo Bucket e Bongo Bowl garantiscono una scorta di drink perfettamente ghiacciati per ogni occasione | With their soft lines and elliptical design the Bongo Bucket and Bongo Bowl, represent a captivating item for the drinks table. Bongo Bucket and Bowl provide perfectly cooled drinks for every occasion

design by MINEDIVINE



IT Bongo Bowl può contenere nel ghiaccio fino a 5 bottiglie di vino e champagne o diverse bottiglie di piccolo formato. Bongo Bucket può ospitare una bottiglia anche inclinata. Ergonomico, di facile manutenzione e molto resistente, Bongo è realizzato in pregiato materiale acrilico altamente trasparente ed è ideale per bar, ristoranti e club.

EN Bongo Bowl can hold up to 5 champagne and wine bottles or several small bottles on ice. Bongo Bucket can also hold a tilted bottle. Ergonomic, easy to maintain and very strong, Bongo is made of premium, clear acrylic material and is an ideal solution for bars, restaurants and clubs.

BONGO BUCKET

art. 1562

MATERIALE / MATERIAL
Acrilico / Acrylic

COLORI / COLOURS
Clear

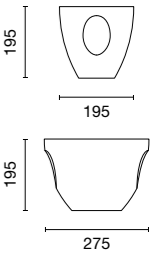

BONGO BOWL

art. 1630

MATERIALE / MATERIAL
Acrilico / Acrylic

COLORI / COLOURS
Clear

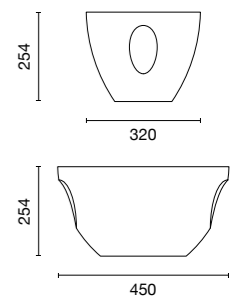

Winston Bucket & Nevada Bowl

Una linea in acciaio inossidabile di secchielli e spumantiera, perfetta per rinfrescare nel ghiaccio le bottiglie di ogni formato elevandone la presentazione al bar ed a tavola | A stainless steel range of buckets and bowl, perfect to refresh bottles of each size elevating their presentation at bar or on the table

design by ITALESSE

IT Winston Bucket è un secchiello da Champagne in acciaio inox inossidabile. Elegante, resistente ed impilabile, Winston Bucket è ideale per rinfrescare la bottiglia in esso contenuta ed accompagnare il servizio professionale con stile. Nella versione large, Winston Bucket Large è dotato di pomelli laterali e può contenere anche 2 bottiglie di vino. Nevada Bowl è perfetta per esporre e mantenere fresche nel ghiaccio fino a 5 bottiglie di Champagne.

EN Winston Bucket is a stainless steel Champagne bucket. Elegant, resistant and stackable, Winston Bucket is perfect for chilling the bottle it contains and it gives style to professional serving. In its larger version, Winston Bucket Large with knobs can contain up to 2 bottles of wine. Nevada Bowl is excellent for presenting and keeping up to 5 bottles of Champagne chilled on ice.

WINSTON BUCKET

art. 1707

MATERIALE / MATERIAL
Stainless steel

COLORI / COLOURS
Inox

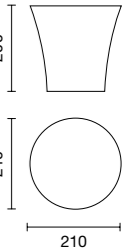

WINSTON BUCKET LARGE

art. 1708

MATERIALE / MATERIAL
Stainless steel

COLORI / COLOURS
Inox

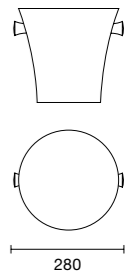

NEVADA BOWL

art. 1709

MATERIALE / MATERIAL
Stainless steel

COLORI / COLOURS
Inox

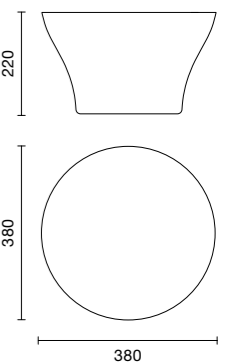

Stripe

Con un profilo sinuoso e futuristico, Stripe è un vassoio dal forte impatto estetico | With its sinuous and futuristic shape, Stripe is a highly decorative tray

design by LUCA NICHETTO



IT Vassoio in materiale ABS, composto da una fascia esterna nera che avvolge un piano rivestito in materiale soft-touch, con funzione anti-scivolo. Le pareti interne rialzate garantiscono grande sicurezza e comodità nel trasporto di piatti e bicchieri e garantiscono una sicurezza ottimale nel servizio anche in condizioni "estreme".

EN A sturdy ABS tray, consisting of a black external band that encircles a surface covered with a soft-touch finish that gives extra hold to the tray contents making it anti-slip. The raised internal walls guarantee safety and comfort when carrying plates and glasses, and guarantee excellent security during busy service and extreme conditions.



STRIPE

art. 6035

MATERIALE / MATERIAL
ABS

COLORI / COLOURS
Black

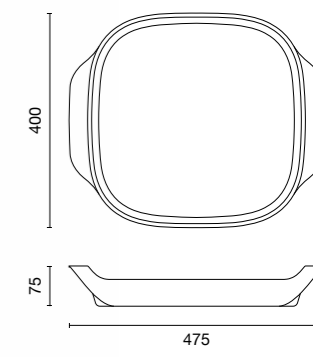

Bolle Cake Stand

L'alzatina Bolle Cake Stand di Italesse cattura l'occhio in qualsiasi contesto e diventa elemento centrale su qualsiasi tavola per l'originale gioco di bolle ad incastro | A unique and polyvalent cake stand that catches the eye in every context and becomes central feature of every table for its original play on light

design by LUCA TRAZZI



IT Caratterizzata da ricche sfere che ricoprono la parte inferiore dell'alzata e da una sinuosa cupola che la ricopre, Bolle Cake Stand diventa, grazie al design vivace e stravagante, un elemento centrale su qualsiasi tavola. Accessorio indispensabile per presentare e servire crostate e torte, nonché selezioni di formaggi o gustosi aperitivi take-away, Bolle Cake Stand è ideale nei bar, per i servizi catering o semplicemente perfetta a casa per presentazioni dal carattere distintivo che vogliono valorizzare il rito della tavola sia in situazioni intime che in affollati momenti conviviali.

EN An indispensable accessory for serving and presenting tarts and cakes as well as varied cheese selections with elegance and originality. Ideal for bars, catering services and just perfect for the home. The Bolle Cake Stand's underside is covered with rich bubbles that refract light and make it the central feature of any table. Complete with its own lightweight cover, Italesse's Bolle Cake Stand makes for a distinctive presentation that serves to shed light on the serving ritual in intimate as well as busy, convivial contexts.

BOLLE CAKE STAND AND DOME

art. 5080
art. 5090

MATERIALE / MATERIAL
Vetro lavorato a mano /
Hand-crafted glass cake stand
SAN dome

COLORI / COLOURS
Clear

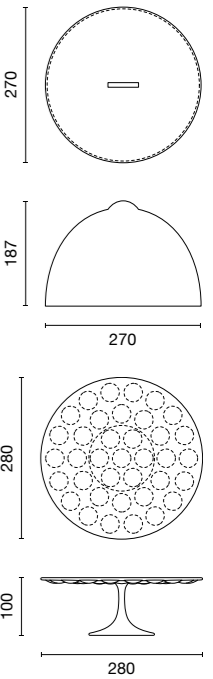

Pebble

Ciotole dalla particolare silhouette che rimanda ai sassolini dei fiumi, con gli angoli smussati che richiamano l'azione dell'acqua corrente / Bowls with the silhouette of a river pebble, with edges smoothed and rounded by the rushing current

design by NENDO



IT Impilabili, minimali ma dotate di grande forza estetica, le ciotole in melamina Pebble possono essere utilizzate per servire snack, olive, finger food ma anche fresche insalate, macedonie, gelati e dolci al cucchiaio.

EN Stackable, minimal, yet featuring great aesthetic impact, the melamine bowls Pebble are suitable for serving snacks, olives, finger food and fresh salads, fruit salads, ice creams and desserts.



PEBBLE SET

art. 5070

MATERIALE / MATERIAL
Melamina / MelamineCOLORI / COLOURS
Mixed Colors

Black - art. 5072

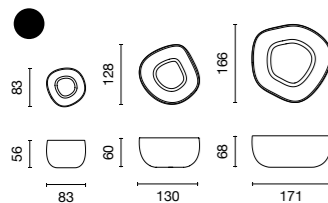

PEBBLE MEDIUM

art. 5061

MATERIALE / MATERIAL
Melamina / MelamineCOLORI / COLOURS
White Black

Orange

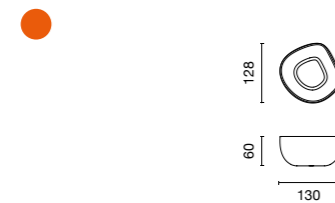

PEBBLE LARGE

art. 5062

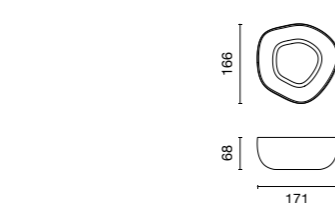
MATERIALE / MATERIAL
Melamina / MelamineCOLORI / COLOURS
Black

PEBBLE SMALL

art. 5060

MATERIALE / MATERIAL
Melamina / MelamineCOLORI / COLOURS
White Black

Djambè Tapas

*Pratiche ciotole in policarbonato
infrangibile caratterizzate da una spiccata
multifunzionalità | Practical unbreakable
polycarbonate bowls characterised
by multipurpose features*

design by LOOKOUT

IT Ideate per accogliere olive, snack, insalate, gelati, appetizer, finger food, le ciotole in policarbonato Djambè Tapas sono pratiche ciotole infrangibili, lavabili in lavastoviglie ed impilabili.

EN Designed for serving olives, snacks, fresh salads, ice creams, appetizers and finger food, Djambè Tapas are unbreakable polycarbonate bowls that are dishwasher safe and stackable.



DJAMBÈ TAPAS LARGE

art. 6020

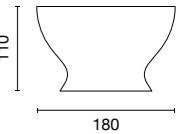
MATERIALE / MATERIAL
Polycrystal®COLORI / COLOURS
Clear

DJAMBÈ TAPAS MEDIUM

art. 6021

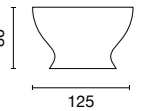
MATERIALE / MATERIAL
Polycrystal®COLORI / COLOURS
Clear

Venti4

Set di piatti e ciotole componibili in bianca melamina satinata per apertivi e stuzzichini | Combinable set of plates and bowls in white melamine with satin finish for appetizers and snacks

design by LUCA NICHETTO



IT La Venti4 Family è un'articolata collezione di piatti e ciotole in melamina satinata, lavabile in lavastoviglie e studiata per offrire un servizio completo, dallo snack veloce, all'aperitivo fino al piatto di servizio – tutti pensati con un design davvero innovativo e originale. Una collezione di piatti piani e a croce, ciotole di varie dimensioni sovrapponibili e assemblabili a piacimento, ideali per servire snack, sushi, salse e guarnizioni – si completa con Venti4 Soup e Dinner Plate, un piatto fondo e uno liscio ideati per ridefinire in maniera innovativa il più classico dei posti tavola, i bar più trendy o i club più straordinari.

EN The Venti4 Family is an articulated collection of satin-finished melamine plates and bowls. Entirely dishwasher-safe, it is designed as a solution for a complete service, from quick snacks, to aperitifs or a plate for table service, all with a truly innovative and original design. A collection of flat, square and cross-shaped plates and cups, stackable and freely assembled bowls of several sizes that are ideal to serve snacks, sushi, sauces and garnishes, the family is complemented by Venti4 Soup and Dinner Plate, a soup plate and a dinner plate created to redefine in an innovative fashion the most classical table, the trendiest bars, or the most luxurious clubs.

VENTI4 BUFFET PLATE

art. 5050

MATERIALE / MATERIAL
Melamina / Melamine

COLORI / COLOURS
White

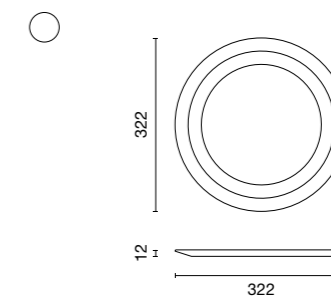

VENTI4 SQUARE CROSS

art. 5054

MATERIALE / MATERIAL
Melamina / Melamine

COLORI / COLOURS
White

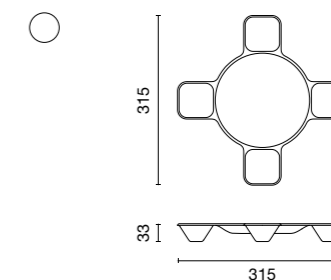

VENTI4 OVAL CROSS

art. 5053

MATERIALE / MATERIAL
Melamina / Melamine

COLORI / COLOURS
White

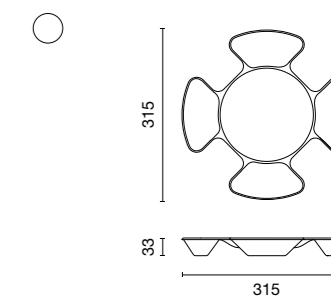

VENTI4 SMALL CUP

art. 5052

MATERIALE / MATERIAL
Melamina / Melamine

COLORI / COLOURS
White

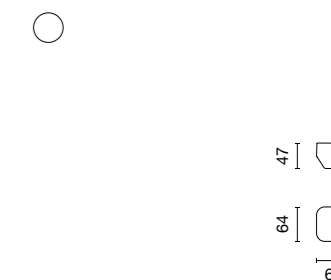

VENTI4 DINNER PLATE

art. 5055

MATERIALE / MATERIAL
Melamina / Melamine

COLORI / COLOURS
White

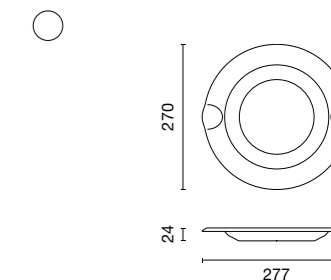

VENTI4 SOUP PLATE

art. 5056

MATERIALE / MATERIAL
Melamina / Melamine

COLORI / COLOURS
White

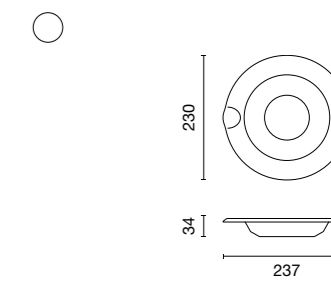

Lollipop

Pratico, colorato, divertente, queste le caratteristiche dello stopper Lollipop | Practical, brightly coloured, fun, these are the characteristics of the Italesse wine-stopper Lollipop

design by MARCO ZANATTA



IT Realizzato in silicone in tre brillanti tonalità di colore, il tappo per bottiglie si presenta a forma di occhio circolare. Originale ed essenziale, può essere appeso al collo della bottiglia nella fase di riposo, trasformando un dettaglio estetico in dettaglio funzionale.

EN Manufactured in silicone in three bright colors, this wine stopper takes the form of a round loop or ring. Original and minimalist in style, it can be hung from the bottle's neck when at rest, transforming an aesthetic detail into a functional feature.

LOLLIPOP

art. 1042

MATERIALE / MATERIAL
Silicone / Silicone

COLORI / COLOURS
White Black



Red

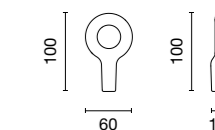

Ocean Stopper

Tappo funzionale, pratico e dall'appeal elegante in grado di conservare perfettamente spumanti e Champagne nel migliore dei modi | Functional, practical stopper with an elegant aesthetic that preserves the quality of Champagne and sparkling wines

design by MINEDIVINE

OCEAN STOPPER

art. 1040

MATERIALE / MATERIAL
 Acrilico, silicone e acciaio inox /
 Acrylic, silicone and stainless steel

COLORI / COLOURS

Clear

White



Black

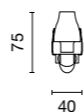

IT Questo stopper è il frutto della ricerca effettuata insieme ai migliori produttori di champagne del mercato; Italesse ha contribuito dando il suo tocco in termini di design. I materiali usati sono l'acrilico, la gomma alimentare per la tettarella e l'acciaio inox per il gancio. La particolarità della tettarella è data dal fatto che con la pressione dello champagne essa si allarga e aderisce alle pareti del collo della bottiglia, garantendo la massima tenuta.

EN This stopper is the result of the research made together with the best champagne producers on the market; Italesse has contributed from the design point of view. Materials used are acrylic, food-grade rubber for the teat and stainless steel for the clasp. The unique feature of the teat is that it expands under the champagne pressure and adheres to the internal walls of the bottle's mouth to guarantee an airlocked seal and thus the wine retains its sparkling properties.

Fiesta Stopper & Fiesta Stopper Plus

Fiesta, divertimento ed eleganza: uno stopper completamente personalizzabile, che preserva perfettamente spumanti e Champagne | Fiesta, fun and elegance: a fully customizable stopper that perfectly preserves sparkling wines and Champagne

design by ITALESSE

FIESTA STOPPER & FIESTA STOPPER PLUS

art. 1043 - Fiesta Stopper
 art. 1044 - Fiesta Stopper Plus

MATERIALE / MATERIAL
 Acrilico, silicone e acciaio inox /
 Acrylic, silicone and stainless steel

COLORI / COLOURS

Clear

White



Black

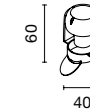

IT Fiesta Stopper conserva le proprietà delicate e gli aromi di tutte le varietà degli spumanti, grazie al suo collaudato meccanismo del gancio e alla tettarella espandibile in silicone. La sua forma richiama il tradizionale tappo da Champagne in sughero, mentre la reinterpretazione in materiale plastico gli dona un taglio decisamente contemporaneo. Nella versione Plus un'innovazione: una capocchia opzionale da inserire sulla testa dello stopper per una personalizzazione alternativa.

EN Fiesta Stopper preserves the delicate properties and aromas of all varieties of sparkling wine, thanks to its tried and tested hook and expandable silicone teat mechanism. Its button top evokes the traditional Champagne cork and Fiesta's interpretation in plastic material gives the accessory a contemporary edge. In the Fiesta Stopper Plus model there is an innovative extra feature: an optional personalizable cap that can be inserted on its head offering an alternative solution for customization.

Designers & Opinion Leaders

**Todd Bracher**

👤 Designer - Industrial and Product Design.
 📍 New York, USA.
 🗑️ Italesse Projects: Vas Carafe.

**Claesson Koivisto Rune**

👤 Design Studio - Industrial Design, Architecture & Interior Design, Product Design.
 📍 Stockholm, Sweden.
 🗑️ Italesse Projects: Richard Juhlin Optimum Champagne Glass, Tonic Glassware and Ice-Buckets.

**Minedivine**

👤 Design Studio - Industrial, Product and Graphic Design.
 📍 Treviso, Italy.
 🗑️ Italesse Projects: Bongo Ice-Buckets, Organica Carafe, Ocean Stopper, Sfera Glassware.

**Luca Nichetto**

👤 Designer - Industrial Design, Architecture, Product Design.
 📍 Stockholm, Sweden.
 🗑️ Italesse Projects: Stripe Tray, Venti4 and Fresnel Collections.

**Marco Zanatta**

👤 Designer - Product Design.
 📍 Varese, Italy.
 🗑️ Italesse Projects: Lollipop Stopper.

**Giancarlo Mancino**

👤 Opinion Leader - Bartender / Bar Consultant.
 📍 Hong Kong.
 🗑️ Italesse Projects: Wormwood Glassware.

**Richard Juhlin**

👤 Opinion Leader - Champagne Expert.
 📍 Stockholm, Sweden.
 🗑️ Italesse Projects: Richard Juhlin Optimum Champagne Glass.

**Maîtres Cuisiniers de France**

👤 Opinion Leader - Largest Worldwide French Chef association.
 📍 Paris, France.
 🗑️ Italesse Projects: Etoilé Glassware.

**Nendo**

👤 Designer - Industrial Design, Architecture, Product Design.
 📍 Tokyo, Japan.
 🗑️ Italesse Projects: Pebble Bowls.

**Carlos Tíscar**

👤 Designer - Industrial and Product Design.
 📍 Valencia, Spain.
 🗑️ Italesse Projects: Solomon Ice-Buckets.

**Luca Trazzi**

👤 Designer - Industrial and Product Design, Architecture.
 📍 Milano, Italy.
 🗑️ Italesse Projects: Bolle Glassware, Ice-Buckets and Accessories, Wormwood Glassware, Plaza Ice-Buckets.

**Federico Venier**

👤 Designer - Industrial Design, Architecture & Interior Design, Product Design.
 📍 London, UK.
 🗑️ Italesse Projects: Vinocchio and Alavin Decanters, Easy Ice-Buckets, Pagoda and Grand Pagoda Ice-Buckets.

**Luca Bini**

👤 Opinion Leader - AIS Sommelier and Hospitality Professional.
 📍 Treviso, Italy.
 🗑️ Italesse Projects: Etoilé Sparkle Flute.

Photography:
Thomas Zanon Larcher
Roberto Maffioli / Italesse
Escapista
Azimut Photo / Massimo Gardone

Graphic Design:
Fabrizio Gabrielli

Print:
Grafica Goriziana

Italesse s.r.l.

Via Dei Templari 6
loc. Noghere - 34015 Muggia
Trieste - Italy

T +39 040 9235555
F +39 040 9235251

italesse@italesse.it
www.italesse.com

© 2018