



zafferano
LAMPES-À-PORTER

zafferano
LAMPES-À-PORTER

Indice delle collezioni

Collections overview

04	10	12	14	16	18
Amelie	Tavolo Table lamp	Terra Floor lamp	Picchetto Lamp with peg	Sospensione Suspension lamp	Parete Wall lamp
20	22	24	26	28	30
Super O	Tavolo Table lamp	Terra Floor lamp	Terra sospesa Ceiling-suspended floor lamp	Sospensione Suspension lamp	Parete Wall lamp
34	40	42	46	48	50
Circe	Tavolo Table lamp	Poldina	Stopper	Lido	Bottiglia Bottle

52	58	60	62	64	
Sister Light Wi-Fi	Tavolo Table lamp	Mini tavolo Mini table lamp	Picchetto Lamp with peg	Parete Wall lamp	
66	68	70	72	74	76
Ofelia	Micro tavolo Micro table lamp	Olivia	Micro tavolo Micro table lamp	Swap	Tavolo Table lamp
78	82	84	85	90	91
Poldina	Parete Wall lamp	Sospensione Suspension lamp	Picchetto Lamp with peg	Tavolo Table lamp	Micro tavolo Micro table lamp
92	94	96	98	100	105
Pina	Tavolo Table lamp	Home Solar	Terra Floor lamp	Liolà	Tavolo Table
106	106	107	111		
Accessori e ricambi Accessories and spares	Accessori Accessories	Basi di ricarica e caricatori Charging bases and chargers	Batterie Battery packs		

Amelie

Design Sara Moroni



Amelie è una collezione di lampade a batteria, portatili e ricaricabili, che comprende le tipologie da tavolo, terra, parete, a sospensione e con picchetto. Le lampade da tavolo, terra, parete e con picchetto vengono fornite con un tappo in silicone e un gancio, che permettono di trasformarli in una sospensione. Un controllo “touch” presente nella parte superiore della testa permette l'accensione, la regolazione dell'intensità luminosa e la selezione della temperatura di colore della luce tra 2200 K, 2700 K e 3000 K. Grazie a un alto indice di protezione, le lampade della collezione sono utilizzabili anche all'esterno. Sono dotate di base di ricarica a contatto. Caricabatterie non incluso.

Amelie is a collection of portable, rechargeable battery-operated lamps that includes the following models: table, floor, wall and suspension lamps, and lamp with peg. The table, floor and wall lamps and lamp with peg are supplied with a silicone cap and a hook, so that they can be transformed into a suspension lamp. On the head, a touch sensor allows you to switch it on, adjust the luminous intensity and select the color temperature of the light to 2200 K, 2700 K or 3000 K. With the high IP rating, the lamps can also be used outdoors. The lamps come with a contact charging base; battery charger not included.



Amelie table lamp
leaf green → LD1090V3



Amelie suspension lamp
leaf green → **LD1091V3**



Amelie wall lamp
white → **LD1092B3**



Amelie lamp with peg
terracotta → **LD1094T3**



Amelie floor lamp
white → **LD1096B3**

Dati tecnici

Technical data

LED TOUCH DIMMER

2200-2700-3000 K | CRI>80
253-300-308 lm | 3 W | IP65
5 Vdc max 1A



Corpo in pressofusione di alluminio verniciato
Painted die-cast aluminum body

Schermo diffusore in policarbonato opale
Opal polycarbonate diffuser

Adatta all'uso esterno (lampada IP65) e interno
(lampada su base di ricarica IP20)
Suitable for outdoor (lamp IP65) and indoor use
(lamp on charging base IP20)

Durata di circa 10 h alla massima potenza
Battery lasts about 10 h at full power

Tempo di ricarica a 1A: 6 h
Charging time at 1A: 6 h

Pacco batteria al litio ricaricabile e sostituibile
Rechargeable and replaceable lithium battery pack

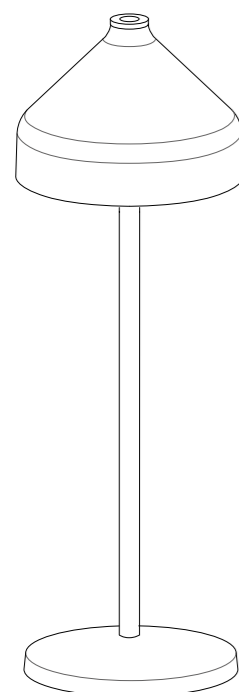

Ø 12 x 34 cm
Ø 4,7 x 13,3 in

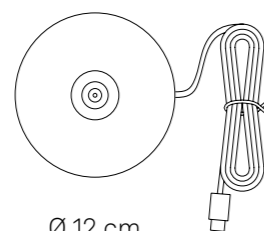

Ø 12 cm
Ø 4,7 in

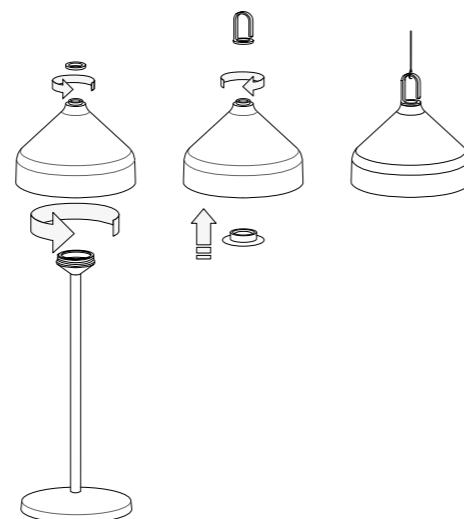
**Componenti inclusi**

Components included

Base di ricarica a contatto
Contact charging base

Accessorio per utilizzo a sospensione
(tappo in silicone e gancio)

Accessories to use as a suspension lamp
(silicon cap and hook)

Accessori non inclusi

Accessories not included

Caricatore / Charger
100-240 V | USB Type A
LD0490UA

Finiture

Finishes



LD1090B3
Bianco / White
RAL 9016



LD1090D3
Nero / Black
RAL 9011



LD1090V3
Verde foglia / Leaf green
RAL 150 60 10



LD1090T3
Terracotta
Pantone 49-12 C



Amelie table lamp
terracotta → **LD1090T3**

Dati tecnici

Technical data

LED TOUCH DIMMER

2200-2700-3000 K | CRI>80

253-300-308 lm | 3 W | IP65

5 Vdc max 1A



Corpo in pressofusione di alluminio verniciato

Painted die-cast aluminum body

Schermo diffusore in policarbonato opale

Opal polycarbonate diffuser

Adatta all'uso esterno (lampada IP65) e interno (lampada su base di ricarica IP20)

Suitable for outdoor (lamp IP65) and indoor use (lamp on charging base IP20)

Durata di circa 10 h alla massima potenza

Battery lasts about 10 h at full power

Tempo di ricarica a 1A: 6 h

Charging time at 1A: 6 h

Pacco batteria al litio ricaricabile e sostituibile

Rechargeable and replaceable lithium battery pack

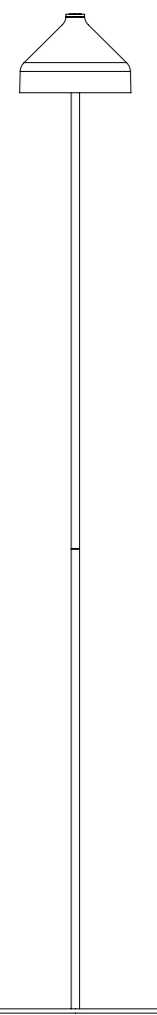

Ø 20 x 120 cm
Ø 7,8 x 47 in

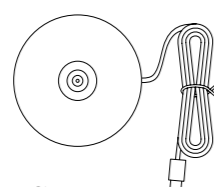

Ø 12 cm
Ø 4,7 in

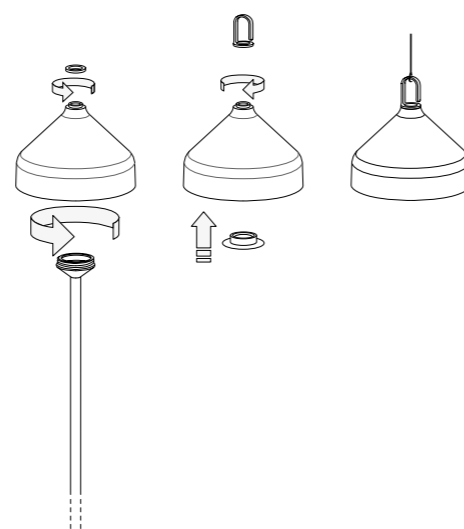
**Componenti inclusi**

Components included

Base di ricarica a contatto

Contact charging base

Accessorio per utilizzo a sospensione (tappo in silicone e gancio)

Accessories to use as a suspension lamp (silicon cap and hook)

Accessori non inclusi

Accessories not included

Caricatore / Charger

100-240 V | USB Type A

LD0490UA

Finiture

Finishes



LD1096B3
Bianco / White
RAL 9016

LD1096D3
Nero / Black
RAL 9011

LD1096V3
Verde foglia / Leaf green
RAL 150 60 10

LD1096T3
Terracotta
Pantone 49-12 C

Dati tecnici

Technical data

LED TOUCH DIMMER

2200-2700-3000 K | CRI>80

253-300-308 lm | 3 W | IP65

5 Vdc max 1A

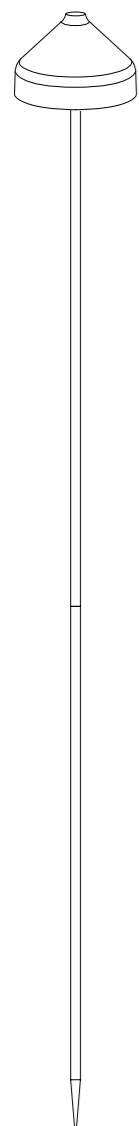

Ø 12 x 120 cm
Ø 4,7 x 47 in

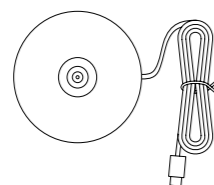

Ø 12 cm
Ø 4,7 in

Corpo in pressofusione di alluminio verniciato

Painted die-cast aluminum body

Schermo diffusore in policarbonato opale

Opal polycarbonate diffuser

Adatta all'uso esterno (lampada IP65) e interno (lampada su base di ricarica IP20)

Suitable for outdoor (lamp IP65) and indoor use (lamp on charging base IP20)

Durata di circa 10 h alla massima potenza

Battery lasts about 10 h at full power

Tempo di ricarica a 1A: 6 h

Charging time at 1A: 6 h

Pacco batteria al litio ricaricabile e sostituibile

Rechargeable and replaceable lithium battery pack

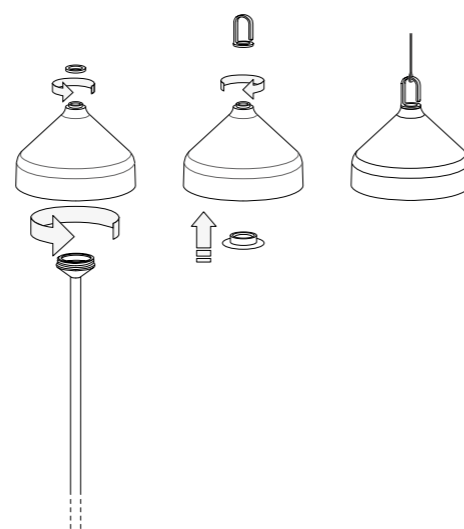
**Componenti inclusi**

Components included

Base di ricarica a contatto

Contact charging base

Accessorio per utilizzo a sospensione (tappo in silicone e gancio)

Accessories to use as a suspension lamp (silicon cap and hook)

Accessori non inclusi

Accessories not included

Caricatore / Charger

100-240 V | USB Type A

LD0490UA

Finiture

Finishes



LD1094B3
Bianco / White
RAL 9016



LD1094D3
Nero / Black
RAL 9011



LD1094V3
Verde foglia / Leaf green
RAL 150 60 10



LD1094T3
Terracotta
Pantone 49-12 C

Dati tecnici

Technical data

LED TOUCH DIMMER

2200-2700-3000 K | CRI>80
253-300-308 lm | 3 W | IP65
5 Vdc max 1A



Corpo in pressofusione di alluminio verniciato
Painted die-cast aluminum body

Schermo diffusore in policarbonato opale
Opal polycarbonate diffuser

Adatta all'uso esterno (lampada IP65) e interno
(lampada su base di ricarica IP20)
Suitable for outdoor (lamp IP65) and indoor use
(lamp on charging base IP20)

Durata di circa 10 h alla massima potenza
Battery lasts about 10 h at full power

Tempo di ricarica a 1A: 6 h
Charging time at 1A: 6 h

Pacco batteria al litio ricaricabile e sostituibile
Rechargeable and replaceable lithium battery pack

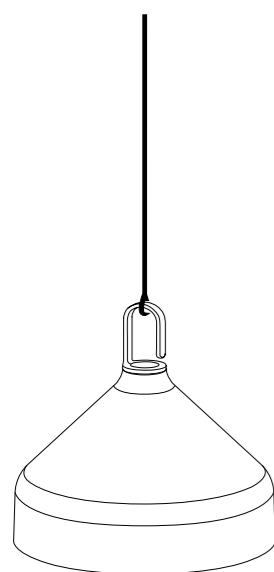

Ø 12 x 12 cm
Ø 4,7 x 4,7 in

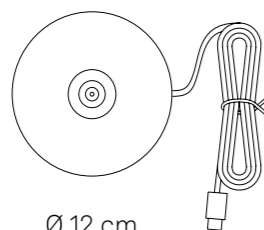

Ø 12 cm
Ø 4,7 in

Componenti inclusi

Components included

Base di ricarica a contatto
Contact charging base

Tappo in silicone e gancio
Silicon cap and hook

Accessori non inclusi

Accessories not included

Caricatore / Charger
100-240 V | USB Type A
LD0490UA

Finiture

Finishes

**LD1091B3**

Bianco / White
RAL 9016

LD1091D3

Nero / Black
RAL 9011

LD1091V3

Verde foglia / Leaf green
RAL 150 60 10

LD1091T3

Terracotta
Pantone 49-12 C



Dati tecnici

Technical data

LED TOUCH DIMMER

2200-2700-3000 K | CRI>80
253-300-308 lm | 3 W | IP65
5 Vdc max 1A



Corpo in pressofusione di alluminio verniciato
Painted die-cast aluminum body

Schermo diffusore in policarbonato opale
Opal polycarbonate diffuser

Adatta all'uso esterno (lampada IP65) e interno
(lampada su base di ricarica IP20)
Suitable for outdoor (lamp IP65) and indoor use
(lamp on charging base IP20)

Durata di circa 10 h alla massima potenza
Battery lasts about 10 h at full power

Tempo di ricarica a 1A: 6 h
Charging time at 1A: 6 h

Pacco batteria al litio ricaricabile e sostituibile
Rechargeable and replaceable lithium battery pack

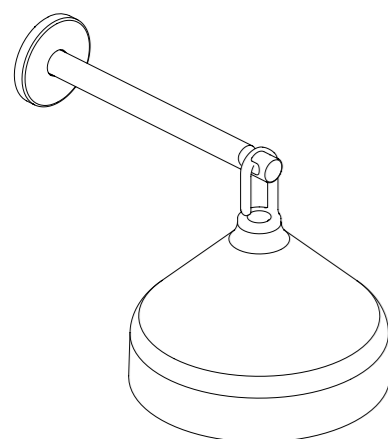

20 x 12 x 14 cm
7,8 x 4,7 x 5,5 in

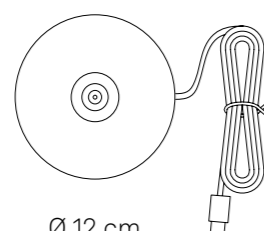

Ø 12 cm
Ø 4,7 in

Componenti inclusi

Components included

Base di ricarica a contatto
Contact charging base

Tappo in silicone e gancio
Silicon cap and hook

Accessori non inclusi

Accessories not included

Caricatore / Charger
100-240 V | USB Type A
LD0490UA

Finiture

Finishes

**LD1092B3**

Bianco / White
RAL 9016

LD1092D3

Nero / Black
RAL 9011

LD1092V3

Verde foglia / Leaf green
RAL 150 60 10

LD1092T3

Terracotta
Pantone 49-12 C



Super O

Design Studio Kairos



Super O è una collezione di lampade a batteria, portatili e ricaricabili che comprende le tipologie da tavolo, terra (in tre modelli), terra sospesa (in tre modelli), parete (in due modelli) e a sospensione. Il modulo luminoso si fissa alla montatura di ciascun modello tramite un magnete, e - ruotando a 360° - permette di orientare la luce. Un controllo "touch" presente nella parte superiore del modulo permette l'accensione, la regolazione dell'intensità luminosa (dimmerazione a 4 step) e la selezione della temperatura di colore della luce tra 2700 K, 3150 K e 4000 K. Grazie a un alto indice di protezione, le lampade della collezione sono utilizzabili anche all'esterno. Possiedono un sistema di controllo elettronico che monitora l'autonomia residua e garantisce un flusso luminoso costante fino all'esaurimento della batteria, permettendo di ottimizzare le ricariche ed effettuarle sempre in maniera corretta. Il modulo si rimuove in modo pratico e si ricarica comodamente connettendolo all'apposito disco di ricarica a contatto. Caricabatterie non incluso.

Super O is a collection of portable, rechargeable battery-operated lamps that includes the following: table, floor (three models), ceiling-suspended floor (three models) and wall (two models) lamps, and a suspension lamp. The lighting module is attached to the frame of the lamps with a magnet. It can rotate 360°, allowing to direct the flow of light. On the head, a touch sensor allows you to switch it on, adjust the luminous intensity (4-step: 100%, 60%, 30%, 6%) and select the color temperature of the light to 2700 K, 3150 K or 4000 K. With the high IP rating, the lamps can also be used outdoors. They feature an electronic control system that monitors the remaining autonomy and ensures a constant luminous flux until the battery runs out; recharging is therefore optimized and always properly done. The module can be easily removed from the frame and conveniently recharged by connecting it to the contact charging base; battery charger not included.



Dati tecnici

Technical data

LED TOUCH DIMMER

2700-3150-4000 K | CRI>90
287-331-336 lm | 3,5 W | IP65
5 Vdc max 2A



Corpo in pressofusione di alluminio verniciato
Painted die-cast aluminum body

Schermo diffusore in policarbonato prismatico
Prismatic polycarbonate diffuser

Adatta all'uso esterno (lampada IP65) e interno
Suitable for outdoor (lamp IP65) and indoor use

Durata di 10 - 160 h, in base alla regolazione
del flusso luminoso
Battery lasts 10 - 160 h, depending on the
luminous flux setting

Tempo di ricarica a 2A: 5 h
Charging time at 2A: 5 h

Pacco batteria al litio ricaricabile e sostituibile
Rechargeable and replaceable lithium battery pack

Finiture

Finishes



LD1152B3
Bianco / White
RAL 9003



LD1152N3
Nero / Black
RAL 9005

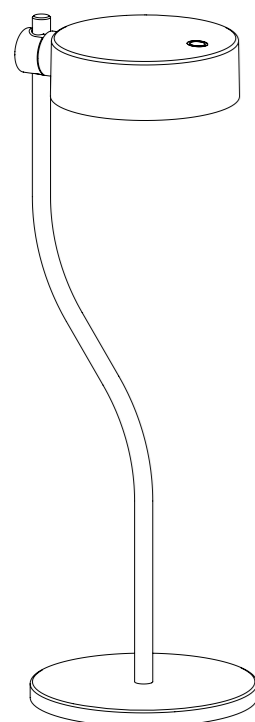

16,6 x 15 x 46 cm
6,5 x 5,9 x 18,1 in

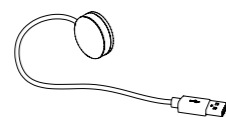

Ø 3 x 1 cm
Ø 1,2 x 0,4 in

Componenti inclusi

Components included

Disco per ricarica a contatto
Contact charging puck

Accessori non inclusi

Accessories not included

Caricatore / Charger
100-240 V | USB Type A (LD0300UC)



Super O table lamp
white → **LD1152B3**

Dati tecnici

Technical data

LED TOUCH DIMMER

2700-3150-4000 K | CRI>90
287-331-336 lm | 3,5 W | IP65
5 Vdc max 2A



Corpo in pressofusione di alluminio verniciato
Painted die-cast aluminum body

Schermo diffusore in policarbonato prismatico
Prismatic polycarbonate diffuser

Adatta all'uso esterno (lampada IP65) e interno
Suitable for outdoor (lamp IP65) and indoor use

Durata di 10 - 160 h, in base alla regolazione
del flusso luminoso
Battery lasts 10 - 160 h, depending on the
luminous flux setting

Tempo di ricarica a 2A: 5 h
Charging time at 2A: 5 h

Pacco batteria al litio ricaricabile e sostituibile
Rechargeable and replaceable lithium battery pack

Finiture

Finishes



Bianco / White
RAL 9003

1 Modulo luce
1 Lighting module
LD1154B3

2 Moduli luce
2 Lighting modules
LD1155B3

3 Moduli luce
3 Lighting modules
LD1156B3



Nero / Black
RAL 9005

1 Modulo luce
1 Lighting module
LD1154N3

2 Moduli luce
2 Lighting modules
LD1155N3

3 Moduli luce
3 Lighting modules
LD1156N3

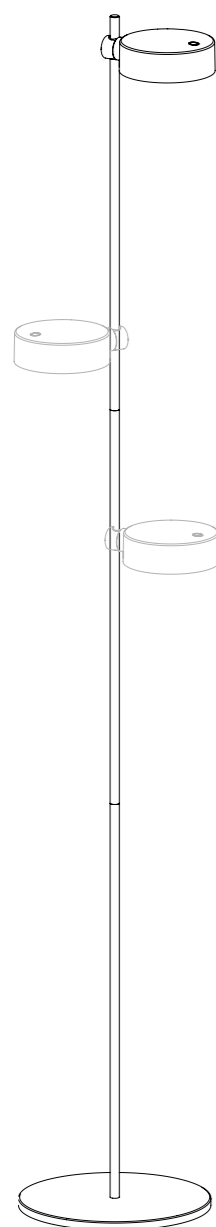

Ø 25 x 160 cm
Ø 9,8 x 63 in

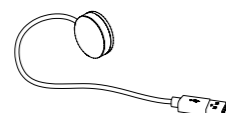

Ø 3 x 1 cm
Ø 1,2 x 0,4 in

Componenti inclusi

Components included

Disco per ricarica a contatto
Contact charging puck

Accessori non inclusi

Accessories not included

Caricatore / Charger
100-240 V | USB Type A (LD0300UC)

Super O floor lamp
(2 Lighting modules) black → **LD1155N3**



Dati tecnici

Technical data

LED TOUCH DIMMER

2700-3150-4000 K | CRI>90
287-331-336 lm | 3,5 W | IP65
5 Vdc max 2A

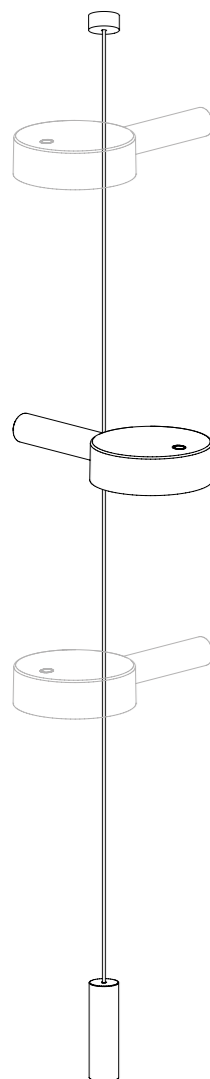

12,5 x 24,7 x 500 cm
4,9 x 9,7 x 196,9 in

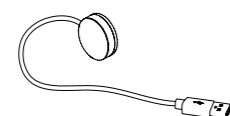

Ø 3 x 1 cm
Ø 1,2 x 0,4 in

Corpo in pressofusione di alluminio verniciato
Painted die-cast aluminum body

Schermo diffusore in policarbonato prismatico
Prismatic polycarbonate diffuser

Adatta all'uso esterno (lampada IP65) e interno
Suitable for outdoor (lamp IP65) and indoor use

Durata di 10 - 160 h, in base alla regolazione
del flusso luminoso
Battery lasts 10 - 160 h, depending on the
luminous flux setting

Tempo di ricarica a 2A: 5 h
Charging time at 2A: 5 h

Pacco batteria al litio ricaricabile e sostituibile
Rechargeable and replaceable lithium battery pack

Finiture

Finishes



Bianco / White
RAL 9003

1 Modulo luce
1 Lighting module
LD1157B3

2 Moduli luce
2 Lighting modules
LD1158B3

3 Moduli luce
3 Lighting modules
LD1159B3



Nero / Black
RAL 9005

1 Modulo luce
1 Lighting module
LD1157N3

2 Moduli luce
2 Lighting modules
LD1158N3

3 Moduli luce
3 Lighting modules
LD1159N3

Componenti inclusi

Components included

Disco per ricarica a contatto / Contact charging puck

Cavo di colore grigio scuro / Dark gray cable

Cavo di colore rosso / Red cable

Contrappeso da terra / Floor counterweight

Contrappeso modulo luce

Counterweight for lighting module

Accessori non inclusi

Accessories not included

Caricatore / Charger

100-240 V | USB Type A (LD0300UC)



Super O ceiling-suspended
floor lamp (1 Lighting module)
black → **LD1157N3**

Dati tecnici

Technical data

LED TOUCH DIMMER

2700-3150-4000 K | CRI>90
 287-331-336 lm | 3,5 W | IP65
 5 Vdc max 2A



Corpo in pressofusione di alluminio verniciato
 Painted die-cast aluminum body

Schermo diffusore in policarbonato prismatico
 Prismatic polycarbonate diffuser

Adatta all'uso esterno (lampada IP65) e interno
 Suitable for outdoor (lamp IP65) and indoor use

Durata di 10 - 160 h, in base alla regolazione
 del flusso luminoso
 Battery lasts 10 - 160 h, depending on the
 luminous flux setting

Tempo di ricarica a 2A: 5 h
 Charging time at 2A: 5 h

Pacco batteria al litio ricaricabile e sostituibile
 Rechargeable and replaceable lithium battery pack

Finiture

Finishes



LD1153B3
 Bianco / White
 RAL 9003



LD1153N3
 Nero / Black
 RAL 9005

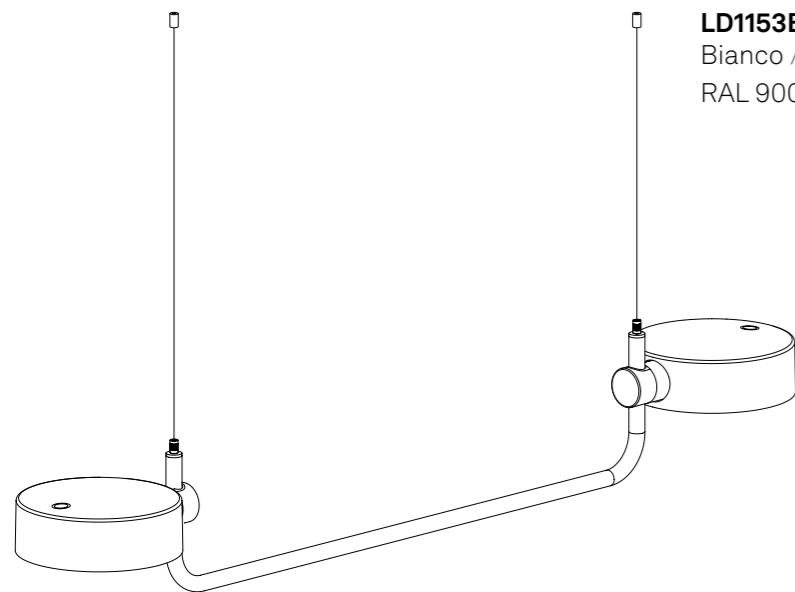

77 x 12,5 x 300 cm
 30,3 x 4,9 x 118,1 in

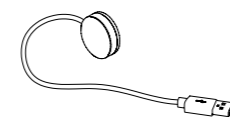

Ø 3 x 1 cm
 Ø 1,2 x 0,4 in

Componenti inclusi

Components included

Disco per ricarica a contatto
 Contact charging puck

Accessori non inclusi

Accessories not included

Caricatore / Charger
 100-240 V | USB Type A (LD0300UC)



Super O suspension lamp
 white → **LD1153B3**

Dati tecnici**Technical data****LED TOUCH DIMMER**

2700-3150-4000 K | CRI>90
287-331-336 lm | 3,5 W | IP65
5 Vdc max 2A



Corpo in pressofusione di alluminio verniciato
Painted die-cast aluminum body

Schermo diffusore in policarbonato prismatico
Prismatic polycarbonate diffuser

Adatta all'uso esterno (lampada IP65) e interno
Suitable for outdoor (lamp IP65) and indoor use

Durata di 10 - 160 h, in base alla regolazione
del flusso luminoso

Battery lasts 10 - 160 h, depending on the
luminous flux setting

Tempo di ricarica a 2A: 5 h

Charging time at 2A: 5 h

Pacco batteria al litio ricaricabile e sostituibile

Rechargeable and replaceable lithium battery pack

Finiture**Finishes**

LD1151B3
Bianco / White
RAL 9003



LD1151N3
Nero / Black
RAL 9005

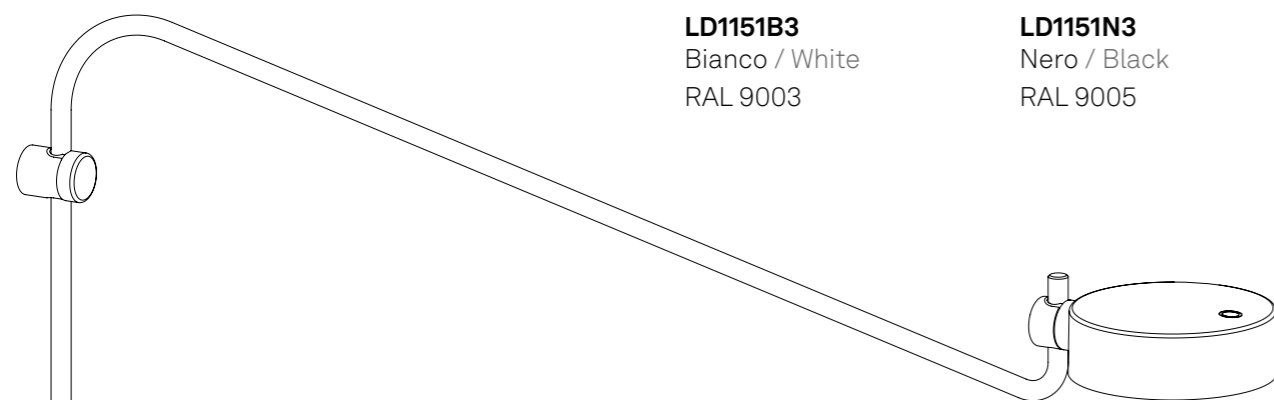

12,5 x 40,5 x 85,3 cm
4,9 x 15,9 x 33,6 in

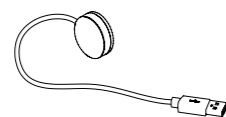

Ø 3 x 1 cm
Ø 1,2 x 0,4 in

Componenti inclusi

Components included

Disco per ricarica a contatto
Contact charging puck

Accessori non inclusi

Accessories not included

Caricatore / Charger
100-240 V | USB Type A (LD0300UC)

Super O wall lamp
white → **LD1151B3**



Dati tecnici

Technical data

LED TOUCH DIMMER

2700-3150-4000 K | CRI>90
287-331-336 lm | 3,5 W | IP65
5 Vdc max 2A



Corpo in pressofusione di alluminio verniciato
Painted die-cast aluminum body

Schermo diffusore in policarbonato prismatico
Prismatic polycarbonate diffuser

Adatta all'uso esterno (lampada IP65) e interno
Suitable for outdoor (lamp IP65) and indoor use

Durata di 10 - 160 h, in base alla regolazione
del flusso luminoso

Battery lasts 10 - 160 h, depending on the
luminous flux setting

Tempo di ricarica a 2A: 5 h

Charging time at 2A: 5 h

Pacco batteria al litio ricaricabile e sostituibile

Rechargeable and replaceable lithium battery pack

Finiture

Finishes

**LD1150B3**

Bianco / White
RAL 9003

**LD1150N3**

Nero / Black
RAL 9005

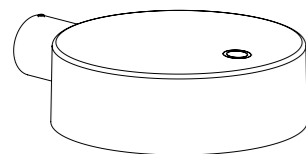

12,5 x 4,3 x 16,2 cm
4,9 x 1,7 x 6,4 in

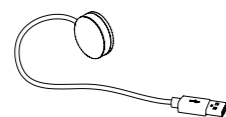

Ø 3 x 1 cm
Ø 1,2 x 0,4 in

Componenti inclusi

Components included

Disco per ricarica a contatto
Contact charging puck

Accessori non inclusi

Accessories not included

Caricatore / Charger
100-240 V | USB Type A (LD0300UC)



Super O wall lamp
black → **LD1150N3**

Circe

Tavolo pro

Table lamp pro



Circe è una lampada da tavolo a batteria, portatile e ricaricabile. Nella parte superiore della testa è presente un pulsante che permette l'accensione, la regolazione dell'intensità luminosa e la selezione della temperatura di colore della luce tra 2200 K e 3000 K (bianco dinamico). Grazie ad un alto indice di protezione, la lampada è utilizzabile anche all'esterno (ad eccezione dei modelli con finitura galvanica, dei quali è sconsigliato l'uso continuativo in esterni). È dotata di base di ricarica a contatto. Caricabatterie non incluso.

Circe is a rechargeable battery-powered cordless table lamp. The knob on the top of the lampshade allows switching on/off, dimming, and tuning the color temperature of the light between 2200 K and 3000 K (Dynamic Tunable White). It is suitable for both indoor and outdoor use (except gold and rose gold finishes). Circe comes with a contact charging base; the battery charger is not included.



Circe table lamp
white → LD1005B3



Circe table lamp
corten → **LD1005R3**

Circe table lamp
white → **LD1005B3**





Circe table lamp
black → **LD1005N3**

Circe table lamp glossy
rose gold → **LD1005E3**



Dati tecnici

Technical data

LED DIMMER

2200-3000 K | CRI>80
214-224 lm | 2,2 W | IP65
5 Vdc max 1A



Corpo in pressofusione di alluminio verniciato
Painted die-cast aluminum body

Schermo diffusore in policarbonato prismatico
Prismatic polycarbonate diffuser

Adatta all'uso esterno (lampada IP65) e interno
(lampada su base di ricarica IP20)
Suitable for outdoor (lamp IP65) and indoor use
(lamp on charging base IP20)

Durata di circa 9 h alla massima potenza
Battery lasts about 9 h at full power

Tempo di ricarica a 1A: 6 h
Charging time at 1A: 6 h

Pacco batteria al litio ricaricabile e sostituibile
Rechargeable and replaceable lithium battery pack

Avvertenze

Remarks

Le lampade con finitura galvanica lucida oro e oro rosa non sono adatte per uso esterno.
The lamps with gold and rose gold glossy galvanic finish are not suitable for outdoor use.

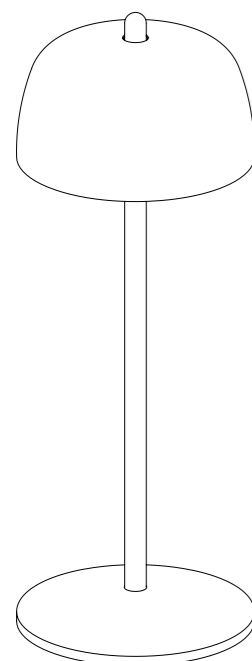

Ø 11 x 30 cm
Ø 4,3 x 11,8 in

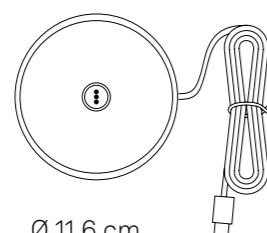

Ø 11,6 cm
Ø 4,5 in

Accessori inclusi

Accessories included

Base di ricarica a contatto
Contact charging base

Accessori non inclusi

Accessories not included

Caricatore / Charger
100-240 V | USB Type A
LD0490UA

Finiture

Finishes

**LD1005B3**

Bianco / White
RAL 9002

**LD1005R3**

Corten

**LD1005N3**

Nero / Black
RAL 9005

**LD1005O3**

Oro lucido / Glossy gold
Galvanic finish

**LD1005E3**

Oro rosa lucido / Glossy rose gold
Galvanic finish

Le lampade con finitura galvanica lucida oro e oro rosa non sono adatte per uso esterno.
The lamps with gold and rose gold glossy galvanic finish are not suitable for outdoor use.

Poldina

Stopper



Poldina è una lampada a batteria, portatile e ricaricabile, con tappo in silicone, che si può inserire su una bottiglia, trasformandola in un oggetto luminoso. Nella parte superiore della testa è presente un controllo "touch", che permette l'accensione, la regolazione dell'intensità luminosa e la selezione della temperatura di colore della luce tra 2200K, 2700K e 3000K. Grazie a un alto indice di protezione, la lampada è utilizzabile anche all'esterno. Possiede un sistema di controllo elettronico che monitora e segnala l'autonomia residua della batteria, permettendo di ottimizzare le ricariche ed effettuarle sempre in maniera corretta. Il tappo in silicone (adatto al contatto alimentare) si adatta a diversi colli di bottiglia e si rimuove in modo pratico, permettendo di ricaricare comodamente la lampada sulla propria base di ricarica a contatto; caricabatterie non incluso. Poldina Stopper è utilizzabile anche con le bottiglie in ceramica "Lido", acquistabili separatamente (pag. 48).

Poldina is a rechargeable battery-operated, cordless lamp. Thanks to a silicone stopper cork, the lamp can be placed on a bottle, turning it into a luminous object. A "touch" control on the head allows switching on/off, dimming, and selecting the color temperature of the light (2200K, 2700K, or 3000K). It is suitable for both indoor and outdoor use. An electronic control system monitors the remaining autonomy and ensures a constant luminous flux until the battery runs out. Recharging is therefore optimized and always properly done. The silicone cap (suitable for food contact) fits different bottle necks and can be easily removed, allowing the lamp to be conveniently recharged on its contact charging base; battery charger not included. Poldina Stopper can also be used with "Lido" ceramic bottles, which can be purchased separately (page 48).



Poldina Stopper black → **LD0349D3**
Lido ceramic bottle black → **FAS1508**



Poldina Stopper black → **LD0349D3**
Lido ceramic bottle black → **FAS1508**

Poldina Stopper sand → **LD0349S3**
Lido ceramic bottle sand → **FAS1507 + PUN1507**



Dati tecnici

Technical data

LED TOUCH DIMMER

2200-2700-3000 K | CRI>80
234-251-256 lm | 2,2 W | IP54
5 Vdc max 1A



Ø 2,5 x 3,8 cm
Ø 1 x 1,5 in

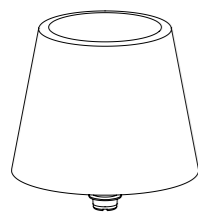

Ø 11,1 x 11,1 cm
Ø 4,4 x 4,4 in

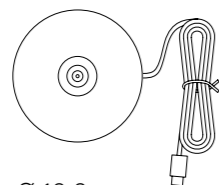

Ø 10,2 cm
Ø 4 in

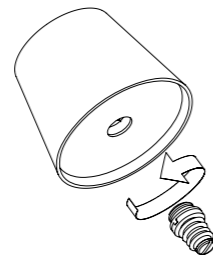

Corpo in pressofusione di alluminio verniciato
Painted die-cast aluminum body

Schermo diffusore in policarbonato
Polycarbonate diffuser

Tappo in silicone
Silicon cover

Adatta all'uso esterno (lampada IP54) e interno
Suitable for outdoor (lamp IP54) and indoor use

Durata di circa 12 h alla massima potenza
Battery lasts about 12 h at full power

Tempo di ricarica a 1A: 6/7 h
Charging time at 1A: 6/7 h

Pacco batteria al litio ricaricabile e sostituibile
Rechargeable and replaceable lithium battery pack

Finiture

Finishes



LD0349B3
Bianco / White
RAL 9003



LD0349A3
Blu avio / Avio blue
Pantone 7468 U



LD0349F3
Rosso / Red
RAL 3000



LD0349G3
Salvia / Sage green
Pantone 5635 U



LD0349S3
Sabbia / Sand



LD0349D3
Nero / Black
RAL 9004

Componenti inclusi

Components included

Base di ricarica a contatto
Contact charging base

Tappo in silicone per Poldina / Poldina silicon cover

Accessori non inclusi

Accessories not included

Caricatore / Charger
100-240 V | USB Type A
LD0490UA



Poldina Stopper Avio blue → **LD0349A3**
Lido ceramic bottle light blue → **RIG1508**

Lido

Design Federico de Majo

Bottiglia in ceramica Ceramic bottle



Bottiglia in ceramica, nella cui imboccatura si può alloggiare la lampada Poldina Stopper.

È prodotta in tre modelli, diversi tra loro per forma e motivo decorativo; ciascun modello è disponibile in cinque colori, con tappo sferico in tinta.

La stretta collaborazione con un'antica fabbrica di Civita Castellana – borgo viterbese dove l'arte della ceramica è attestata fin dal X secolo a.C. – consente a Zafferano di avvalersi di una produzione esclusiva di manufatti "Made in Italy", decorati a mano su disegno proprio.

Ceramic bottle in whose mouth the Poldina Stopper lamp can be placed.

It is produced in three models, different in shape and decorative motif; each model is available in five colors, with matching spherical cap.

The close collaboration with an ancient factory in Civita Castellana, a village in the Viterbo area where the art of ceramics has been attested since the 10th century B.C., allows Zafferano to take advantage of an exclusive production of "Made in Italy" artifacts, hand-decorated according to its own design.



Lido ceramic bottle green → FAS1505

Dati tecnici

Technical data

Ceramica decorata a mano
Hand-painted ceramic

Tappo ermetico, in materiale plastico,
adatto al contatto alimentare
Airtight plastic stopper, suitable for
food contact

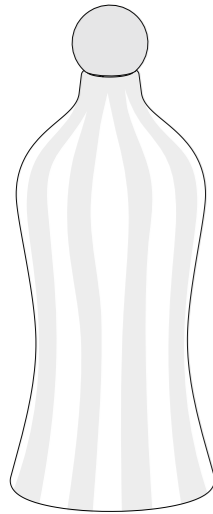

Ø 11 x 26,5 cm
Ø 4,3 x 10,4 in
90 cl

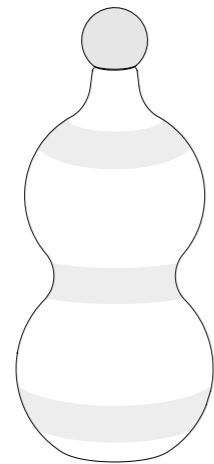

Ø 10,4 x 24,5 cm
Ø 4,1 x 9,6 in
82 cl

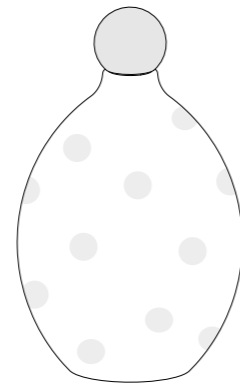

Ø 13 x 20,5 cm
Ø 5,1 x 8,1 in
114 cl



Finiture

Finishes



RIG1501
Righe azzurre
Light blue stripes



RIG1502
Righe rosse
Red stripes



RIG1505
Righe verdi
Green stripes



RIG1507
Righe sabbia
Sand stripes



RIG1508
Righe nere
Black stripes



FAS1501
Fasce azzurre
Light blue bands



FAS1502
Fasce rosse
Red bands



FAS1505
Fasce verdi
Green bands



FAS1507
Fasce sabbia
Sand bands



FAS1508
Fasce nere
Black bands



PUN1501
Pois azzurri
Light blue dots



PUN1502
Pois rossi
Red dots



PUN1505
Pois verdi
Green dots



PUN1507
Pois sabbia
Sand dots



PUN1508
Pois neri
Black dots

Sister Light

WI-FI

Design Federico de Majo



Video Sister
Light Wi-Fi ↗



Sister Light Wi-Fi è una nuova collezione di lampade a batteria, portatili e ricaricabili, controllabili anche da remoto mediante l'utilizzo dell'applicazione Zafferano Lighting. La collezione comprende le tipologie da tavolo (in due altezze), parete e con picchetto. Un controllo "touch" presente nella parte superiore della testa permette accensione, dimmerazione a 4 step e selezione della temperatura di colore della luce (2200 K, 2700 K, 3000 K e 4000 K). L'app permette molti controlli aggiuntivi (*). Grazie all'indice di protezione IP65, sono utilizzabili anche all'esterno; sono inoltre resistenti alla nebbia salina (1500 h). Possiedono un sistema di controllo elettronico che monitora l'autonomia residua e garantisce un flusso luminoso costante fino all'esaurimento della batteria, permettendo di ottimizzare le ricariche ed effettuarle sempre in maniera corretta. Tutti i modelli si ricaricano svitando la testa e ponendola sulla base di ricarica a contatto, inclusa; i modelli da tavolo si ricaricano anche appoggiando la lampada sulla base di ricarica a contatto. Caricabatterie non incluso.

Sister Light Wi-Fi is a new collection of portable, rechargeable battery-operated lamps that can be remote controlled using the Zafferano Lighting app. The collection includes the following models: table lamp (two heights), wall lamp and lamp with peg. On the head, a touch control allows you to turn it on/off, dim (4-step: 100%, 60%, 30%, 6%) and select the color temperature of the light among 2200 K, 2700 K, 3000 K and 4000 K. Many additional controls are available in app (*). With their IP65 rating, the lamps can also be used outdoors; they are salt spray resistant (1500 h). All models feature an electronic control system that monitors the remaining autonomy and ensures a constant luminous flux until the battery runs out. Recharging is therefore optimized and always properly done. All models can be recharged by unscrewing the top and positioning it on the contact charging base, included. The table versions can be recharged also by positioning the whole lamp on the contact charging base. Battery charger not included.

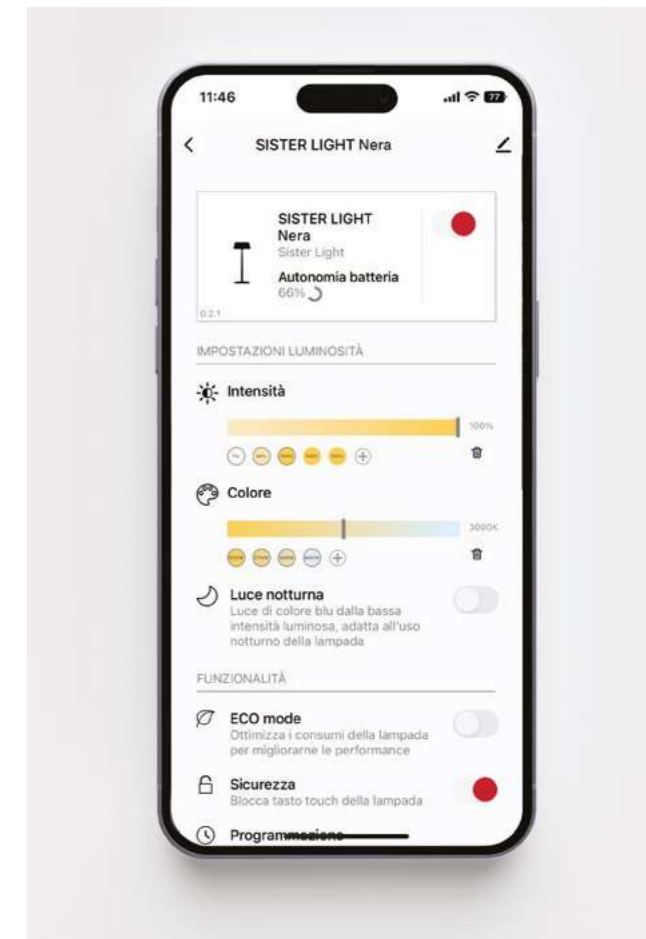

(* Zafferano Lighting App

- Creare e controllare gruppi di lampade
- Dimmer 1-100 con possibilità di creare step personalizzati
- Bianco dinamico (2200K-4000K) con possibilità di creare step personalizzati
- Disabilitazione del "touch" di controllo
- Controllo del livello di carica della batteria
- Timer spegnimento lampada
- Luce notturna
- Eco-Mode
- Disabilitazione del LED di stato
- Definizione tempo di connessione al Wi-Fi
- Modalità emergenza
- Grouping lamps for all-at-once control
- Dimming 1-100 and preset custom dim levels
- Tunable Dynamic White (2200K-4000K) and preset custom color temperature levels
- Disabling touch control
- Monitoring battery charge level
- Time programming (lamp off)
- Activating night light
- Activating Eco Mode
- Disabling status LED
- Wi-Fi connection time-setting
- Activating Emergency Mode



Download Zafferano Lighting App



Sister Light Wi-Fi
table lamp ivory → LD108013



Sister Light Wi-Fi
wall lamp copper → LD1082R3



Sister Light Wi-Fi
table lamp mini gold → **LD108103**



Sister Light Wi-Fi lamp with peg
pearly white → **LD1083B3**

Dati tecnici

Technical data

LED TOUCH DIMMER

2200-2700-3000-4000 K | CRI>90
250-275-296-338 lm | 3,2 W | IP65
5 Vdc max 2A



Corpo in alluminio anodizzato spazzolato
(oro, rame, verde) oppure verniciato
(bianco perlato, nero perlato, avorio)
Brushed anodized (gold, copper, green) or painted
aluminum body (pearly white, pearly black, ivory)

Diffusore in policarbonato prismatico
Prismatic polycarbonate diffuser

Adatta all'uso esterno (lampada IP65) e interno
(lampada su base di ricarica IP20)
Suitable for outdoor (lamp IP65) and indoor use
(lamp on charging base IP20)

Resistenza agli urti (IK07) e alla nebbia salina (1500h)
Impact resistance (IK07) and salt spray resistance
(1500h)

Durata 8 - 58 h, in base alla regolazione del flusso
luminoso e alle impostazioni del Wi-Fi
Battery lasts 8 - 58 h, depending on the luminous
flux and Wi-Fi setting

Tempo di ricarica a 2A: 5 h
Charging time at 2A: 5 h

Pacco batteria al litio ricaricabile e sostituibile
Rechargeable and replaceable lithium battery pack

AVVERTENZE / REMARKS

Per poter funzionare, la lampada deve essere
collegata a una rete Wi-Fi con frequenza 2,4 GHz.
In order to work, the lamp must be connected
to a 2.4 GHz frequency Wi-Fi network.

Firmware del dispositivo aggiornabile da remoto.
Remotely upgradable device firmware.

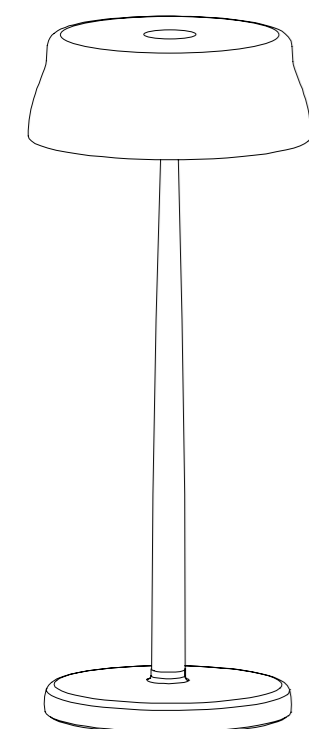

Ø 13,2 x 33 cm
Ø 5,2 x 13 in

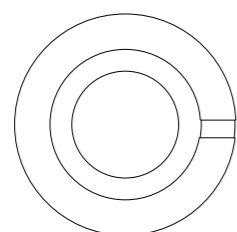

Ø 11,3 cm
Ø 4,4 in

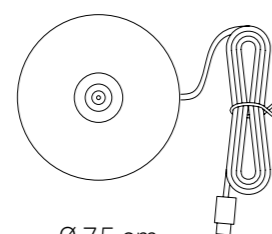

Ø 7,5 cm
Ø 3 in

Componenti inclusi

Components included

Base di ricarica a contatto
Contact charging base

Adattatore per base di ricarica a contatto
Contact charging base adapter

Accessori non inclusi

Accessories not included

Caricatore / Charger
100-240 V | USB Type A
LD0300UC

Finiture

Finishes



LD108003
Oro / Gold



LD1080R3
Rame / Copper



LD1080V3
Verde / Green



LD1080B3
Bianco perlato / Pearly white
RAL 9010



LD1080D3
Nero perlato / Pearly black
RAL 9011



LD1080I3
Avorio / Ivory
RAL 1015

Dati tecnici

Technical data

LED TOUCH DIMMER

2200-2700-3000-4000 K | CRI>90
250-275-296-338 lm | 3,2 W | IP65
5 Vdc max 2A



Corpo in alluminio anodizzato spazzolato
(oro, rame, verde) oppure verniciato
(bianco perlato, nero perlato, avorio)
Brushed anodized (gold, copper, green) or painted
aluminum body (pearly white, pearly black, ivory)

Diffusore in policarbonato prismatico
Prismatic polycarbonate diffuser

Adatta all'uso esterno (lampada IP65) e interno
(lampada su base di ricarica IP20)
Suitable for outdoor (lamp IP65) and indoor use
(lamp on charging base IP20)

Resistenza agli urti (IK07) e alla nebbia salina (1500h)
Impact resistance (IK07) and salt spray resistance
(1500h)

Durata 8 - 58 h, in base alla regolazione del flusso
luminoso e alle impostazioni del Wi-Fi
Battery lasts 8 - 58 h, depending on the luminous
flux and Wi-Fi setting

Tempo di ricarica a 2A: 5 h
Charging time at 2A: 5 h

Pacco batteria al litio ricaricabile e sostituibile
Rechargeable and replaceable lithium battery pack

AVVERTENZE / REMARKS

Per poter funzionare, la lampada deve essere
collegata a una rete Wi-Fi con frequenza 2,4 GHz.
In order to work, the lamp must be connected
to a 2.4 GHz frequency Wi-Fi network.

Firmware del dispositivo aggiornabile da remoto.
Remotely upgradable device firmware.

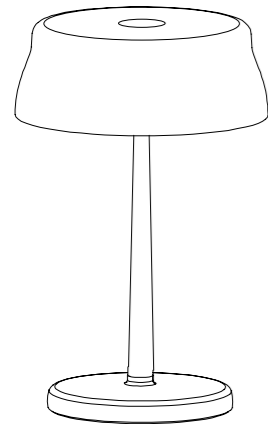

Ø 13,2 x 17 cm
Ø 5,2 x 6,7 in

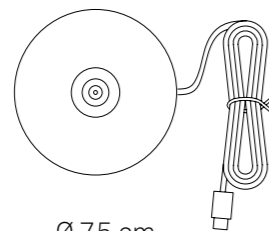

Ø 7,5 cm
Ø 3 in

Componenti inclusi

Components included

Base di ricarica a contatto
Contact charging base

Accessori non inclusi

Accessories not included

Caricatore / Charger
100-240 V | USB Type A
LD0300UC

Finiture

Finishes

**LD108103**

Oro / Gold

**LD1081R3**

Rame / Copper

**LD1081V3**

Verde / Green

**LD1081B3**Bianco perlato / Pearly white
RAL 9010**LD1081D3**Nero perlato / Pearly black
RAL 9011**LD1081I3**Avorio / Ivory
RAL 1015

Dati tecnici

Technical data

LED TOUCH DIMMER

2200-2700-3000-4000 K | CRI>90
250-275-296-338 lm | 3,2 W | IP65
5 Vdc max 2A



Corpo in alluminio anodizzato spazzolato
(oro, rame, verde) oppure verniciato
(bianco perlato, nero perlato, avorio)
Brushed anodized (gold, copper, green) or painted
aluminum body (pearly white, pearly black, ivory)

Diffusore in policarbonato prismatico
Prismatic polycarbonate diffuser

Adatta all'uso esterno (lampada IP65) e interno
(lampada su base di ricarica IP20)
Suitable for outdoor (lamp IP65) and indoor use
(lamp on charging base IP20)

Resistenza agli urti (IK07) e alla nebbia salina (1500h)
Impact resistance (IK07) and salt spray resistance
(1500h)

Durata 8 - 58 h, in base alla regolazione del flusso
luminoso e alle impostazioni del Wi-Fi
Battery lasts 8 - 58 h, depending on the luminous
flux and Wi-Fi setting

Tempo di ricarica a 2A: 5 h
Charging time at 2A: 5 h

Pacco batteria al litio ricaricabile e sostituibile
Rechargeable and replaceable lithium battery pack

AVVERTENZE / REMARKS

Per poter funzionare, la lampada deve essere
collegata a una rete Wi-Fi con frequenza 2,4 GHz.
In order to work, the lamp must be connected
to a 2.4 GHz frequency Wi-Fi network.

Firmware del dispositivo aggiornabile da remoto.
Remotely upgradable device firmware.

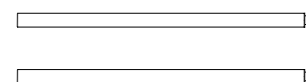
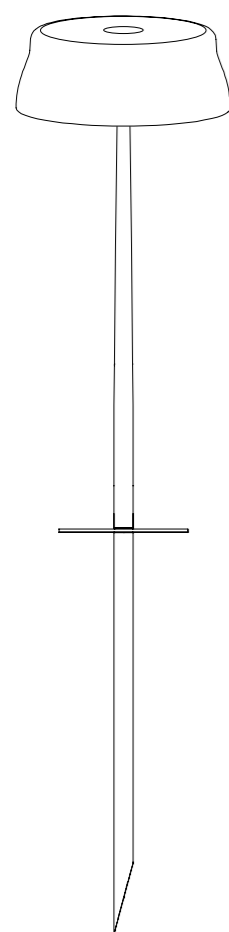

25 cm
9,8 in

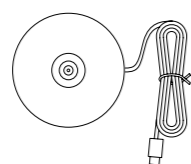

Ø 7,5 cm
Ø 3 in

Ø 13,2 x 58-83-106 cm
Ø 5,2 x 22,8-32,6-41,7 in

Componenti inclusi

Components included

Base di ricarica a contatto
Contact charging base
Stelo (2 pz.) / Stem (2 pcs.)

Accessori non inclusi

Accessories not included

Caricatore / Charger
100-240 V | USB Type A
LD0300UC

Finiture

Finishes



LD1083O3
Oro / Gold



LD1083R3
Rame / Copper



LD1083V3
Verde / Green



LD1083B3
Bianco perlato / Pearly white
RAL 9010



LD1083D3
Nero perlato / Pearly black
RAL 9011



LD1083I3
Avorio / Ivory
RAL 1015

Dati tecnici

Technical data

LED TOUCH DIMMER

2200-2700-3000-4000 K | CRI>90

250-275-296-338 lm | 3,2 W | IP65

5 Vdc max 2A



Corpo in alluminio anodizzato spazzolato (oro, rame, verde) oppure verniciato (bianco perlato, nero perlato, avorio)
Brushed anodized (gold, copper, green) or painted aluminum body (pearly white, pearly black, ivory)

Diffusore in policarbonato prismatico
Prismatic polycarbonate diffuser

Adatta all'uso esterno (lampada IP65) e interno (lampada su base di ricarica IP20)

Suitable for outdoor (lamp IP65) and indoor use (lamp on charging base IP20)

Resistenza agli urti (IK07) e alla nebbia salina (1500h)
Impact resistance (IK07) and salt spray resistance (1500h)

Durata 8 - 58 h, in base alla regolazione del flusso luminoso e alle impostazioni del Wi-Fi
Battery lasts 8 - 58 h, depending on the luminous flux and Wi-Fi setting

Tempo di ricarica a 2A: 5 h
Charging time at 2A: 5 h

Pacco batteria al litio ricaricabile e sostituibile
Rechargeable and replaceable lithium battery pack

AVVERTENZE / REMARKS

Per poter funzionare, la lampada deve essere collegata a una rete Wi-Fi con frequenza 2,4 GHz.
In order to work, the lamp must be connected to a 2.4 GHz frequency Wi-Fi network.

Firmware del dispositivo aggiornabile da remoto.
Remotely upgradable device firmware.

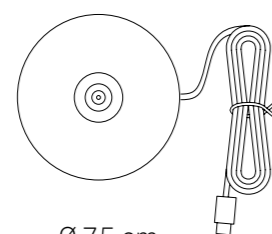
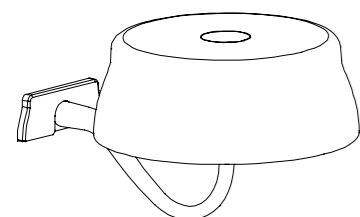

9,8 x 13,2 x 18 cm
3,5 x 5,1 x 7,1 in

Ø 7,5 cm
Ø 3 in

Componenti inclusi

Components included

Base di ricarica a contatto
Contact charging base

Accessori non inclusi

Accessories not included

Caricatore / Charger
100-240 V | USB Type A
LD0300UC

Finiture

Finishes



LD108203
Oro / Gold



LD1082R3
Rame / Copper



LD1082V3
Verde / Green



LD1082B3
Bianco perlato / Pearly white
RAL 9010



LD1082D3
Nero perlato / Pearly black
RAL 9011



LD1082I3
Avorio / Ivory
RAL 1015

Ofelia micro

Tavolo pro

Table lamp pro



Ofelia micro è una lampada da tavolo a batteria, portatile e ricaricabile. Nella parte superiore della testa è presente un controllo "touch", che permette l'accensione, la regolazione dell'intensità luminosa e la selezione della temperatura di colore della luce tra 2200 K, 2700 K e 3000 K. Ofelia micro possiede inoltre la funzione di memoria dell'impostazione di dimmerazione, che memorizza gli step di dimmerazione. Grazie a un alto indice di protezione, la lampada è utilizzabile anche all'esterno. È dotata di base di ricarica a contatto; caricabatterie incluso.

Ofelia micro is a rechargeable battery-powered cordless table lamp. A "touch" control on the head allows switching on/off, dimming, and selecting the color temperature of the light (2200 K, 2700 K or 3000 K). Ofelia micro is equipped with the dimmer memory function, which adjusts the light intensity and memorizes the dimmer steps. It is suitable for both indoor and outdoor use. The lamp comes with a contact charging base; battery charger included.



Ofelia micro table lamp corten → **LD1880R3**
Ofelia micro table lamp sand → **LD1880S3**

Dati tecnici

Technical data

LED TOUCH DIMMER

2200-2700-3000 K | CRI>80
183-195-216 lm | 2,2 W | IP65
5 Vdc max 1A



Corpo in pressofusione di alluminio verniciato
Painted die-cast aluminum body

Schermo diffusore in policarbonato
Polycarbonate diffuser

Adatta all'uso esterno (lampada IP65) e interno
(lampada su base di ricarica IP20)
Suitable for outdoor (lamp IP65) and indoor use
(lamp on charging base IP20)

Durata di circa 9 h alla massima potenza
Battery lasts about 9 h at full power

Tempo di ricarica a 1A: 4,5 h
Charging time at 1A: 4,5 h

Pacco batteria al litio ricaricabile e sostituibile
Rechargeable and replaceable lithium battery pack

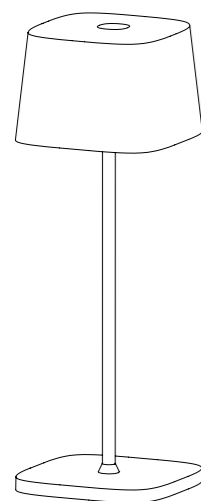

6,7 x 6,7 x 20 cm
2,6 x 2,6 x 7,9 in

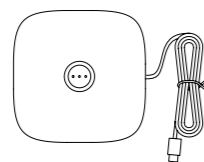

7,1 x 7,1 cm
2,8 x 2,8 in

Componenti inclusi

Components included

Base di ricarica a contatto
Contact charging base

Accessori non inclusi

Accessories not included

Caricatore / Charger
100-240 V | USB Type A
LD0490UA

Finiture

Finishes



LD1880B3
Bianco / White
RAL 9016



LD1880R3
Corten



LD1880N3
Grigio scuro
/ Dark gray
RAL 7024



LD1880S3
Sabbia / Sand
RAL 1014



LD1880G3
Salvia / Sage green
Pantone 5635 U



Olivia micro

Tavolo pro

Table lamp pro



Olivia micro è una lampada da tavolo a batteria, portatile e ricaricabile. Nella parte superiore della testa è presente un controllo "touch", che permette l'accensione, la regolazione dell'intensità luminosa e la selezione della temperatura di colore della luce tra 2200 K, 2700 K e 3000 K. Olivia micro possiede inoltre la funzione di memoria dell'impostazione di dimmerazione, che memorizza gli step di dimmerazione. Grazie a un alto indice di protezione, la lampada è utilizzabile anche all'esterno. È dotata di base di ricarica a contatto; caricabatterie incluso.

Olivia micro is a rechargeable battery-powered cordless table lamp. A "touch" control on the head allows switching on/off, dimming, and selecting the color temperature of the light (2200 K, 2700 K or 3000 K). Olivia micro is equipped with the dimmer memory function, which adjusts the light intensity and memorizes the dimmer steps; consequently, every time it is switched on, the light intensity will correspond to that previously set. It is suitable for both indoor and outdoor use. The lamp comes with a contact charging base; battery charger included.



Olivia micro table lamp
white → LD1840B3

Dati tecnici

Technical data

LED TOUCH DIMMER

2200-2700-3000 K | CRI>80
183-187-225 lm | 2,2 W | IP65
5 Vdc max 1A



Corpo in pressofusione di alluminio verniciato
Painted die-cast aluminum body

Schermo diffusore in policarbonato
Polycarbonate diffuser

Adatta all'uso esterno (lampada IP65) e interno
(lampada su base di ricarica IP20)
Suitable for outdoor (lamp IP65) and indoor use
(lamp on charging base IP20)

Durata di circa 9 h alla massima potenza
Battery lasts about 9 h at full power

Tempo di ricarica a 1A: 4,5 h
Charging time at 1A: 4,5 h

Pacco batteria al litio ricaricabile e sostituibile
Rechargeable and replaceable lithium battery pack

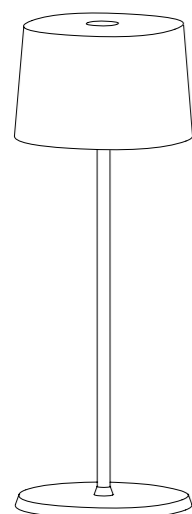

Ø 7,5 x 20 cm
Ø 2,9 x 7,9 in

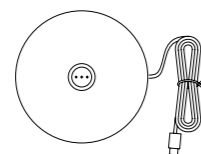

Ø 7,9 cm
Ø 3,1 in

Componenti inclusi

Components included

Base di ricarica a contatto
Contact charging base

Accessori non inclusi

Accessories not included

Caricatore / Charger
100-240 V | USB Type A
LD0490UA

Finiture

Finishes



LD1840B3
Bianco / White
RAL 9016



LD1840R3
Corten



LD1840N3
Grigio scuro / Dark gray
RAL 7012



LD1840S3
Sabbia / Sand
RAL 1014



Olivia table lamp dark gray → **LD0850N3**
Olivia mini table lamp dark gray → **LD0860N3**
Olivia micro table lamp dark gray → **LD1840N3**

Swap

Tavolo pro

Table lamp pro



Rispetto alla precedente, la nuova versione di Swap permette anche la regolazione dell'intensità luminosa (dimmerazione a 4 step) e la selezione della temperatura di colore della luce tra 2200 K, 2700 K e 3000 K. La nuova Swap inoltre ha altezza ridotta (29 cm). Swap è una lampada da tavolo a batteria, portatile e ricaricabile. Grazie a un alto indice di protezione, la lampada è utilizzabile anche all'esterno. Possiede un sistema di controllo elettronico che monitora e segnala l'autonomia residua della batteria, permettendo di ottimizzare le ricariche ed effettuarle sempre in maniera corretta. Swap è personalizzabile con paralumi in vetro, ceramica o tessuto, acquistabili separatamente. È dotata di base di ricarica a contatto; caricabatterie non incluso.

Compared to the previous one, the new version of Swap allows also dimming (4-step: 100%, 60%, 30%, 6%) and selecting the color temperature of the light to 2200 K, 2700 K or 3000 K. The new Swap is also smaller (29 cm / 11,4 in). Swap is a rechargeable battery-powered cordless table lamp. It is suitable for both indoor and outdoor use. An electronic control system monitors the remaining autonomy and ensures a constant luminous flux until the battery runs out. Recharging is therefore optimized and always properly done. Swap can be customized with glass, ceramic, or fabric lampshades, to be purchased separately. The lamp comes with a contact charging base; battery charger not included.



Swap table lamp black + fabric lampshade black
→ LD1030N3 + LD102005

Dati tecnici

Technical data

LED TOUCH DIMMER

2200-2700-3000 K | CRI>90

141-168-192 lm | 2 W | IP65

5 Vdc max 2A



Corpo in pressofusione di alluminio verniciato

Painted die-cast aluminum body

Schermo diffusore in policarbonato satinato

Satin polycarbonate diffuser

Adatta all'uso esterno (lampada IP65) e interno

(lampada su base di ricarica IP20)

Suitable for outdoor (lamp IP65) and indoor use

(lamp on charging base IP20)

Durata di circa 13 h alla massima potenza

Battery lasts about 13 h at full power

Tempo di ricarica a 2A: 3 h

Charging time at 2A: 3 h

Pacco batteria al litio ricaricabile e sostituibile

Rechargeable and replaceable lithium battery pack

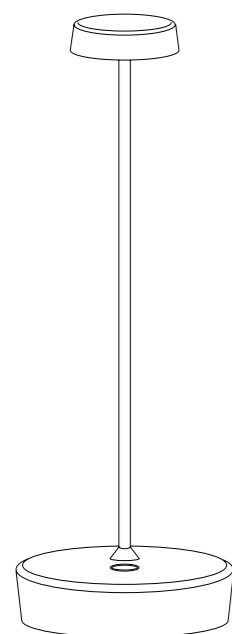

Ø 10 x 29 cm
Ø 3,9 x 11,4 in

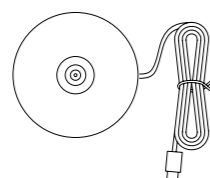

Ø 7,5 cm
Ø 2,9 in

Finiture

Finishes

**LD1030B3**

Bianco / White

RAL 9002

**LD1030R3**

Corten

**LD1030N3**

Nero / Black

RAL 9005

Componenti inclusi

Components included

Base di ricarica a contatto

Contact charging base

Accessori non inclusi

Accessories not included

Caricatore / Charger

100-240 V | USB Type A

LD0300UC

Swap table lamp black → **LD1030N3**

Resort IKOS Andalusia

Marbella-Estepona, Spain

Photo Ikos Resorts

Poldina

Parete pro

Wall lamp pro

Sospensione pro

Suspension lamp pro

Picchetto pro

Lamp with peg pro



Nuove versioni di Poldina picchetto, parete e sospensione dotate di testa magnetica che si rimuove in modo pratico e si ricarica comodamente sulla propria base di ricarica a contatto; caricabatterie incluso. Poldina è una lampada a batteria, portatile e ricaricabile con picchetto. Nella parte superiore della testa è presente un controllo "touch", che permette l'accensione, la regolazione dell'intensità luminosa e la selezione della temperatura di colore della luce tra 2200 K, 2700 K e 3000 K. Grazie a un alto indice di protezione, la lampada è utilizzabile anche all'esterno. Possiede un sistema di controllo elettronico che monitora e segnala l'autonomia residua della batteria, permettendo di ottimizzare le ricariche ed effettuarle sempre in maniera corretta.

New versions of Poldina with peg, wall, and suspension lamp with magnetic head, which can be removed easily and recharged conveniently on their own contact charging base; the battery charger is included.

Poldina is a rechargeable battery-powered cordless lamp with peg. A "touch" control on the head allows switching on/off, dimming, and selecting the color temperature of the light (2200 K, 2700 K or 3000 K). It is suitable for both indoor and outdoor use. An electronic control system monitors the remaining autonomy and ensures a constant luminous flux until the battery runs out. Recharging is therefore optimized and always properly done.

Poldina suspension lamp
white → LD0686B3





Poldina wall lamp
dark gray → **LD0688N3**



Poldina lamp with peg
white → **LD0682B3**

Dati tecnici

Technical data

LED TOUCH DIMMER

2200-2700-3000 K | CRI>80
234-251-256 lm | 2,2 W | IP54
5 Vdc max 1A



Corpo in pressofusione di alluminio verniciato
Painted die-cast aluminum body

Schermo diffusore in policarbonato
Polycarbonate diffuser

Adatta all'uso esterno (lampada IP54) e interno
(lampada su base di ricarica IP20)
Suitable for outdoor (lamp IP54) and indoor use
(lamp on charging base IP20)

Durata di circa 9 h alla massima potenza
Battery lasts about 9 h at full power

Tempo di ricarica a 1A: 6 h
Charging time at 1A: 6 h

Pacco batteria al litio ricaricabile e sostituibile
Rechargeable and replaceable lithium battery pack

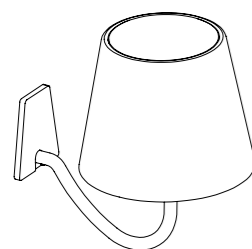

15,8 x 14 cm
6,2 x 5,5 in

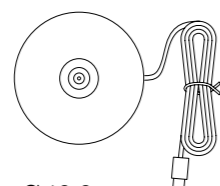

Ø 10,2 cm
Ø 4 in

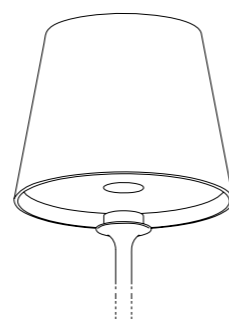
**Finiture**

Finishes



LD0688B3
Bianco / White
RAL 9003



LD0688R3
Corten



LD0688N3
Grigio scuro
/ Dark gray

Componenti inclusi

Components included

Base di ricarica a contatto
Contact charging base

Accessori non inclusi

Accessories not included

Caricatore / Charger
100-240 V | USB Type A
LD0490UA

Dati tecnici

Technical data

LED TOUCH DIMMER

2200-2700-3000 K | CRI>80
234-251-256 lm | 2,2 W | IP54
5 Vdc max 1A



Corpo in pressofusione di alluminio verniciato
Painted die-cast aluminum body

Schermo diffusore in policarbonato
Polycarbonate diffuser

Adatta all'uso esterno (lampada IP54) e interno
(lampada su base di ricarica IP20)
Suitable for outdoor (lamp IP54) and indoor use
(lamp on charging base IP20)

Durata di circa 9 h alla massima potenza
Battery lasts about 9 h at full power

Tempo di ricarica a 1A: 6 h
Charging time at 1A: 6 h

Pacco batteria al litio ricaricabile e sostituibile
Rechargeable and replaceable lithium battery pack

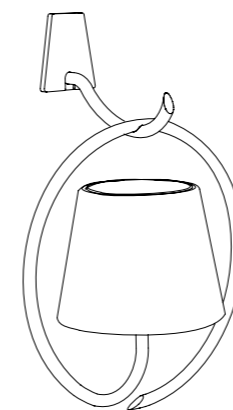

12,5 x 14 cm
4,8 x 10,4 in

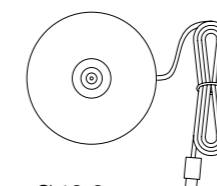

Ø 10,2 cm
Ø 4 in

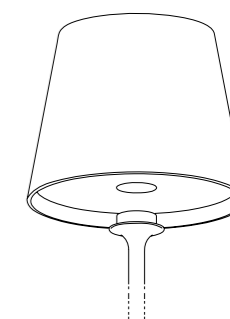
**Finiture**

Finishes



LD0689B3
Bianco / White
RAL 9003



LD0689R3
Corten



LD0689N3
Grigio scuro
/ Dark gray

Componenti inclusi

Components included

Base di ricarica a contatto
Contact charging base

Accessori non inclusi

Accessories not included

Caricatore / Charger
100-240 V | USB Type A
LD0490UA

Dati tecnici

Technical data

LED TOUCH DIMMER

2200-2700-3000 K | CRI>80
234-251-256 lm | 2,2 W | IP54
5 Vdc max 1A



Corpo in pressofusione di alluminio verniciato
Painted die-cast aluminum body

Schermo diffusore in policarbonato
Polycarbonate diffuser

Adatta all'uso esterno (lampada IP54) e interno
(lampada su base di ricarica IP20)
Suitable for outdoor (lamp IP54) and indoor use
(lamp on charging base IP20)

Durata di circa 9 h alla massima potenza
Battery lasts about 9 h at full power

Tempo di ricarica a 1A: 6 h
Charging time at 1A: 6 h

Pacco batteria al litio ricaricabile e sostituibile
Rechargeable and replaceable lithium battery pack

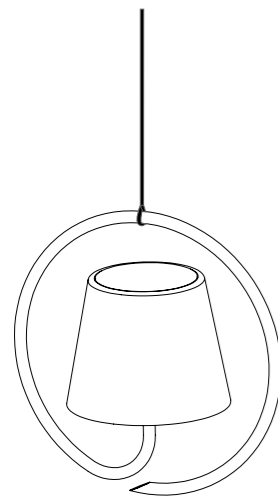

19,8 x 19,8 x 11 cm
7,8 x 7,8 x 4,3 in

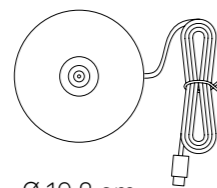

Ø 10,2 cm
Ø 4 in

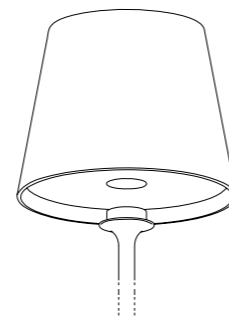
**Finiture**

Finishes



LD0686B3
Bianco / White
RAL 9003



LD0686R3
Corten



LD0686N3
Grigio scuro
/ Dark gray

Componenti inclusi

Components included

Base di ricarica a contatto
Contact charging base

Accessori non inclusi

Accessories not included

Caricatore / Charger
100-240 V | USB Type A
LD0490UA

Dati tecnici

Technical data

LED TOUCH DIMMER

2200-2700-3000 K | CRI>80
234-251-256 lm | 2,2 W | IP54
5 Vdc max 1A



Corpo in pressofusione di alluminio verniciato
Painted die-cast aluminum body

Schermo diffusore in policarbonato
Polycarbonate diffuser

Adatta all'uso esterno (lampada IP54) e interno
(lampada su base di ricarica IP20)
Suitable for outdoor (lamp IP54) and indoor use
(lamp on charging base IP20)

Durata di circa 9 h alla massima potenza
Battery lasts about 9 h at full power

Tempo di ricarica a 1A: 6 h
Charging time at 1A: 6 h

Pacco batteria al litio ricaricabile e sostituibile
Rechargeable and replaceable lithium battery pack

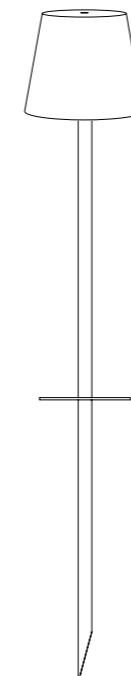

Ø 11 x 60 cm
Ø 4,3 x 23,6 in

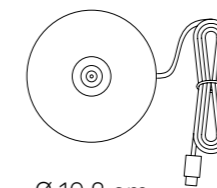

Ø 10,2 cm
Ø 4 in

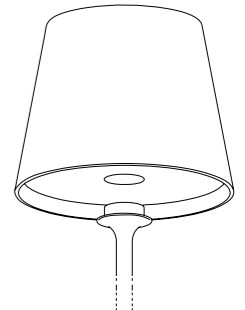
**Avvertenze / Remarks**

La stabilità della lampada è garantita
con l'uso di massimo tre prolunghe
The stability of the lamp is guaranteed
when using three extensions maximum

Finiture

Finishes



LD0682B3
Bianco / White
RAL 9003



LD0682R3
Corten



LD0682N3
Grigio scuro
/ Dark gray

Componenti inclusi

Components included

Base di ricarica a contatto
Contact charging base

Accessori non inclusi

Accessories not included

Caricatore / Charger
100-240 V | USB Type A
LD0490UA

Poldina

Poldina micro

Tavolo pro
Table lamp pro



Video Poldina ↗



La finitura craquelé è realizzata tramite l'applicazione manuale di una foglia metallica color oro: questa lavorazione imita un disegno di screpolature superficiali, che rivelano il colore di fondo creando un gradevole contrasto cromatico e di texture.

Come le altre lampade portatili e ricaricabili già a catalogo, queste nuove versioni sono in alluminio pressofuso; si accendono, spengono e regolano con un tocco; si ricaricano con l'apposita base a contatto; permettono di scegliere la temperatura di colore della luce a LED tra 2200 K, 2700 K e 3000 K.

Adatte esclusivamente a uso interno.

The craquelé finish is created through the manual application of a gold-colored metal leaf: this process imitates a superficial pattern of cracks, which reveal the background color, creating a pleasing contrast in color and texture.

Just like the other portable and rechargeable lamps in the Zafferano catalog, these new versions are made of die-cast aluminum; they are turned on/off, and dimmed with a touch; they are recharged with a contact base; and they allow the user to choose the color temperature of the LED light between 2200 K, 2700 K, and 3000 K. The lamps are not suitable for outdoor use.



Poldina table lamp
red - gold color leaf → **LD034OFFO**



Poldina table lamp micro
 Capri blue - gold color leaf → **LD0490KFO**
 Poldina table lamp
 Avio blue - gold color leaf → **LD0340AFO**



Poldina table lamp micro
 black - gold color leaf → **LD0490DFO**

Dati tecnici

Technical data

LED TOUCH DIMMER

2200-2700-3000 K | CRI>80
234-251-256 lm | 2,2 W | IP65
50-60 Hz | 5 Vdc max 1A



Corpo in pressofusione di alluminio verniciato
Painted die-cast aluminum body

Schermo diffusore in policarbonato
Polycarbonate diffuser

Durata di circa 12 h alla massima potenza
Battery lasts about 12 h at full power

Tempo di ricarica a 1A: 6/7 h
Charging time at 1A: 6/7 h

Pacco batteria al litio ricaricabile e sostituibile
Rechargeable and replaceable lithium battery pack

Avvertenze

Remarks

Le lampade con finitura craquelé non sono adatte per uso esterno.
The lamps with craquelé finish are not suitable for outdoor use.

Per effetto della natura manuale della tecnica adottata nella lavorazione con foglia metallica, l'aspetto finale della finitura delle lampade può risultare differente. Eventuali difformità attestano il pregio e l'unicità di ciascuna lampada e non vanno considerate come imperfezioni.

Due to the manual nature of the technique adopted in the application of the metal foil, the final appearance of the lamps' finishing can be different. Any apparent imperfections attest to the quality and exclusivity of each lamp and should not be considered as imperfections.

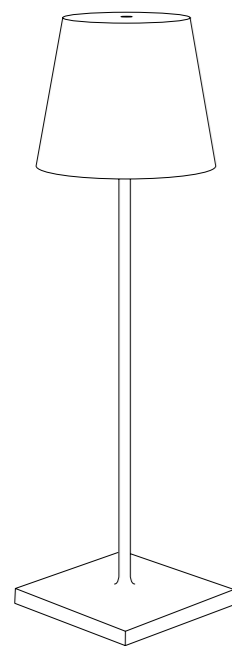

Ø 11 x 38 cm
Ø 4,3 x 15 in

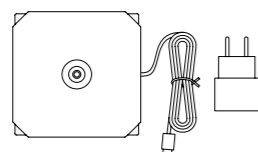

9,4 x 9,4 cm
3,7 x 3,7 in

Finiture

Finishes



LD0340DFO

Nero - Foglia color oro craquelé / Black - Gold color leaf
RAL 9004



LD0340AFO

Blu avio - Foglia color oro craquelé / Avio blue - Gold color leaf craquelé
Pantone 7468 U



LD0340FFO

Rosso - Foglia color oro craquelé / Red - Gold color leaf craquelé
RAL 3000

Componenti inclusi

Components included

Base di ricarica a contatto e caricatore
Contact charging base and charger

Dati tecnici

Technical data

LED TOUCH DIMMER

2200-2700-3000 K | CRI>80
174-177-195 lm | 1,8 W | IP65
5 Vdc max 1A



Corpo in pressofusione di alluminio verniciato
Painted die-cast aluminum body

Schermo diffusore in policarbonato
Polycarbonate diffuser

Durata di circa 7/8 h alla massima potenza
Battery lasts about 7/8 h at full power

Tempo di ricarica a 1A: 3 h
Charging time at 1A: 3 h

Pacco batteria al litio ricaricabile e sostituibile
Rechargeable and replaceable lithium battery pack

Avvertenze

Remarks

Le lampade con finitura craquelé non sono adatte per uso esterno.
The lamps with craquelé finish are not suitable for outdoor use.

Per effetto della natura manuale della tecnica adottata nella lavorazione con foglia metallica, l'aspetto finale della finitura delle lampade può risultare differente. Eventuali difformità attestano il pregio e l'unicità di ciascuna lampada e non vanno considerate come imperfezioni.

Due to the manual nature of the technique adopted in the application of the metal foil, the final appearance of the lamps' finishing can be different. Any apparent imperfections attest to the quality and exclusivity of each lamp and should not be considered as imperfections.

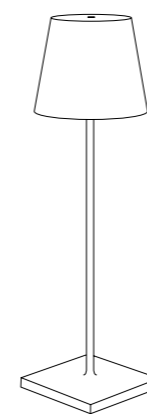

Ø 7 x 27,5 cm
Ø 2,8 x 10,8 in

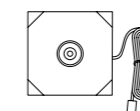

6,7 x 6,7 cm
2,6 x 2,6 in

Finiture

Finishes



LD0490DFO

Nero - Foglia color oro craquelé / Black - Gold color leaf
RAL 9004



LD0490KFO

Blu Capri - Foglia color oro craquelé / Capri blue - Gold color leaf craquelé
RAL 5019



LD0490FFO

Rosso - Foglia color oro craquelé / Red - Gold color leaf craquelé
RAL 3000

Componenti inclusi

Components included

Base di ricarica a contatto
Contact charging base

Accessori non inclusi

Accessories not included

Caricatore / Charger
100-240 V | USB Type A
LD0490UA

Pina

Tavolo pro

Table lamp pro



Pina è una lampada da tavolo a batteria, portatile e ricaricabile. Sulla base è presente un controllo "touch", che permette l'accensione, la regolazione dell'intensità luminosa e la selezione della temperatura di colore della luce tra 2200 K, 2700 K e 3000 K. Possiede un sistema di controllo elettronico che monitora e segnala l'autonomia residua della batteria, permettendo di ottimizzare le ricariche ed effettuarle sempre in maniera corretta. È dotata di base di ricarica a contatto; caricabatterie incluso.

Pina is a rechargeable battery-powered cordless table lamp. A "touch" control on the base allows switching on/off, dimming, and selecting the color temperature of the light (2200 K, 2700 K or 3000 K). An electronic control system monitors the remaining autonomy and ensures a constant luminous flux until the battery runs out. Recharging is therefore optimized and always properly done. The lamp comes with a contact charging base; battery charger included.



Pina table lamp
black - gold color leaf → LD1650DFO

Dati tecnici

Technical data

LED TOUCH DIMMER

2200-2700-3000 K | CRI>80
 178-204-206 lm | 2,2 W | IP54
 50-60 Hz | 5 Vdc max 1A



Corpo in pressofusione di alluminio verniciato

Painted die-cast aluminum body

Schermo diffusore in policarbonato

Polycarbonate diffuser

Durata di circa 12 h alla massima potenza

Battery lasts about 12 h at full power

Tempo di ricarica a 1A: 6/7 h

Charging time at 1A: 6/7 h

Pacco batteria al litio ricaricabile e sostituibile

Rechargeable and replaceable lithium battery pack

Avvertenze

Remarks

Le lampade con finitura craquelé non sono adatte per uso esterno.

The lamps with craquelé finish are not suitable for outdoor use.

Per effetto della natura manuale della tecnica adottata nella lavorazione con foglia metallica, l'aspetto finale della finitura delle lampade può risultare differente. Eventuali difformità attestano il pregio e l'unicità di ciascuna lampada e non vanno considerate come imperfezioni.

Due to the manual nature of the technique adopted in the application of the metal foil, the final appearance of the lamps' finishing can be different. Any apparent imperfections attest to the quality and exclusivity of each lamp and should not be considered as imperfections.

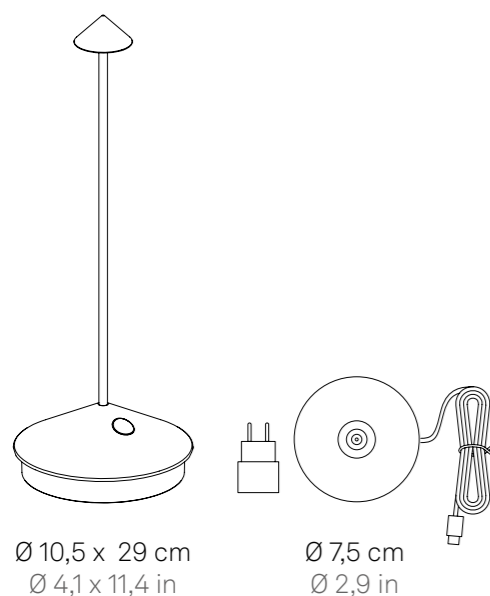
**Finiture**

Finishes

**LD1650DFO**

Nero - Foglia color oro craquelé
 / Black - Gold color leaf

RAL 9004

Componenti inclusi

Components included

Base di ricarica a contatto e caricatore
 Contact charging base and charger

Pina table lamp
 black - gold color leaf → **LD1650DFO**



Home Solar

Paletto Bollard



Paletto adatto all'uso esterno, disponibile in due modelli: basso, alto. Ha struttura in pressofusione di alluminio verniciato grigio scuro o corten e diffusore in polycarbonato trasparente. Home Solar è privo di collegamento alla rete elettrica e dotato di pannello solare, sensore crepuscolare, sensore di movimento e picchetto per installazione diretta su terreno. I sensori della lampada sono comandati da due interruttori: quando il sensore crepuscolare è attivo (☾) e rileva una luminosità ambientale minore di 150 Lux, la lampada si accende al 50% della sua intensità; quando anche il sensore di movimento è attivo (👤) e rileva un movimento, la lampada si accende al massimo della sua potenza per poi abbassarla al 10%.

Bollard lamp for outdoor use, available in two models: low and high. It has a dark grey or corten painted die-cast aluminum frame and a transparent polycarbonate diffuser. Home Solar is mains-independent and fitted with a solar panel, dusk sensor, motion sensor and peg for inserting it directly into the ground. The lamp sensors are controlled by two switches: when the dusk sensor is active (☾) and detects an ambient brightness of less than 150 Lux, the lamp switches on at 50% of its intensity. When the motion sensor is active (👤), too, and detects movement, the lamp switches on at full power, and then lower its intensity to 10%.



Home Solar bollard
dark gray → LD0257G3

Dati tecnici

Technical data

LED
3000 K | 3,7 V | CRI>84
415 lm | 2,2 W | IP54



Corpo in pressofusione di alluminio verniciato
Die-cast painted aluminum body
Schermo diffusore in policarbonato
Polycarbonate diffuser
Lampada dotata di sensore crepuscolare
e di movimento
Lamp fitted with dusk and motion sensors
Ricarica: 6-8 h (luce solare)
Charge: 6-8 h (sunshine)
Durata batteria: luce piena 10-11h; micro 20 - 25h
Work time: Full power 10-11h; energy saving 20 - 25h

Componenti inclusi

Components included

Viti per cemento e picchetto in metallo
Screws and metal peg

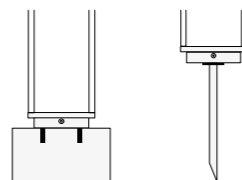

Accessori non inclusi

Accessories not included

Base zavorrata / Stabilizing base
Accessorio per stabilizzare la lampada
senza ancorarla al terreno.
Accessory to stabilise the lamp without
anchoring it to the ground.



16 x 16 x 0,8 cm
6,3 x 6,3 x 0,3 in



LD0255R3
Corten



LD0255G3
Grigio scuro
Dark gray

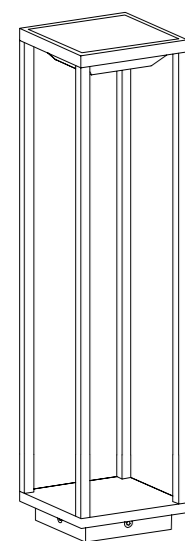

14 x 14 x 50 cm
5,5 x 5,5 x 19,7 in

Finiture

Finishes



LD0256R3
Corten



LD0256G3
Grigio scuro
/ Dark gray

Dati tecnici

Technical data

LED
3000 K | 3,7 V | CRI>84
415 lm | 2,2 W | IP54



Corpo in pressofusione di alluminio verniciato
Die-cast painted aluminum body
Schermo diffusore in policarbonato
Polycarbonate diffuser
Lampada dotata di sensore crepuscolare
e di movimento
Lamp fitted with dusk and motion sensors
Ricarica: 6-8 h (luce solare)
Charge: 6-8 h (sunshine)
Durata batteria: luce piena 10-11h; micro 20 - 25h
Work time: Full power 10-11h; energy saving 20 - 25h

Componenti inclusi

Components included

Viti per cemento e picchetto in metallo
Screws and metal peg

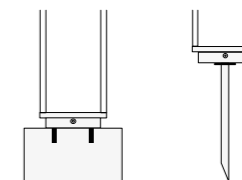

Accessori non inclusi

Accessories not included

Base zavorrata / Stabilizing base
Accessorio per stabilizzare la lampada
senza ancorarla al terreno.
Accessory to stabilise the lamp without
anchoring it to the ground.

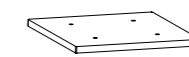

16 x 16 x 0,8 cm
6,3 x 6,3 x 0,3 in



LD0255R3
Corten



LD0255G3
Grigio scuro
Dark gray

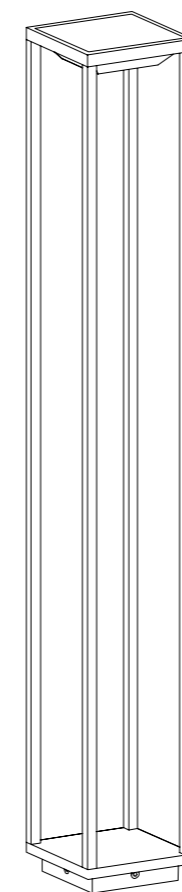

14 x 14 x 100 cm
5,5 x 5,5 x 39,4 in

Finiture

Finishes



LD0257R3
Corten



LD0257G3
Grigio scuro
/ Dark gray

Liolà

Tavolo Table



Tavolini composti da un piano rotondo in termoplastico e tre gambe in legno di frassino, disponibili in otto varianti: alto oppure basso, con piano bianco oppure nero, con gambe in colore naturale oppure verniciate nere. Realizzati con materiali di qualità, in collaborazione con artigiani e laboratori selezionati, i tavolini Liolà sono progettati per un uso professionale nel settore ristorazione, ma sono adatti anche all'uso domestico, anche come svuotatasche o per appendere una borsa.

Tables composed of a round thermoplastic top and three ash wood legs, available in eight variations: tall or low, with a white or black top, with legs in natural color or painted black. Liolà tables are made in collaboration with selected artisans and workshops, using high quality materials, and are designed for professional use in restaurants, but are also suitable for home use, for example as a tray or to hang a bag.



Liolà high table
black - natural wood → **ZLS0104**



Liolà table
black - black wood → **ZLS0005**



Liolà high table
white - natural wood → **ZLS0101**



Liola table white - natural wood → **ZLS0001**
 Liola high table white - natural wood → **ZLS0101**

Dati tecnici Technical data

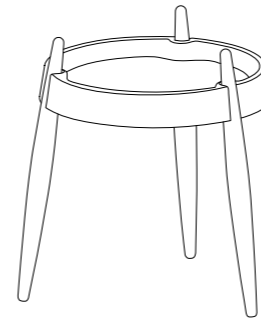

Ø 40 x 47 cm
 Ø 15,7 x 18,5 in

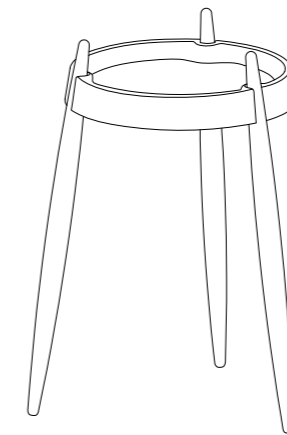

Ø 40 x 67 cm
 Ø 15,7 x 26,4 in

Piano in termoplastico
 Thermoplastic top
 Gambe in legno di frassino
 Wood legs



Finiture Finishes



ZLS0001
 Bianco - Frassino naturale
 White - Natural wood



ZLS0002
 Bianco - Frassino nero
 White - Black wood



ZLS0004
 Nero - Frassino naturale
 Black - Natural wood



ZLS0005
 Nero - Frassino nero
 Black - Black wood



ZLS0101
 Bianco - Frassino naturale
 White - Natural wood



ZLS0102
 Bianco - Frassino nero
 White - Black wood



ZLS0104
 Nero - Frassino naturale
 Black - Natural wood



ZLS0105
 Nero - Frassino nero
 Black - Black wood

Accessori

Accessories



Super O
Modulo luce aggiuntivo
Additional lighting module
Bianco / White
LD1060B3



Super O
Modulo luce aggiuntivo
Additional lighting module
Nero / Black
LD1060N3

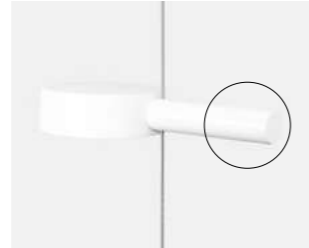

Super O
Contrappeso per modulo luce
Counterweight for additional
light module
Bianco / White
LD1063B3



Super O
Contrappeso per modulo luce
Counterweight for additional
light module
Nero / Black
LD1063N3



Poldina
Copper
LD0349A3 Blu Avio / Avio blue
LD0349B3 Bianco / White
LD0349D3 Nero / Black
LD0349F3 Rosso / Red
LD0349G3 Salvia / Sage green
LD0349S3 Sabbia / Sand



Poldina
Tappo per testa in silicone
Silicone head plug
LD0349TP



Caricabatterie con entrata USB
USB port power charger
LD0490UA

INPUT: AC 100-240V | 50-60Hz
OUTPUT: 5Vdc - max 1 A



Caricabatterie con doppia entrata USB
e spina intercambiabile (EU/USA/UK)
Dual USB port power charger and an
interchangeable plug suitable for EU/
USA/UK
LD0300UC

INPUT: AC 100-240V | 50-60Hz
OUTPUT: 5Vdc - max 2,1 A



Caricatore multiplo 8 prese USB
8 x USB ports multi charger

40W
INPUT: AC 100-240V | 50-60Hz
OUTPUT: 5Vdc - max 8A (8 pcs.)
LD0340RA



Poldina table lamp
Base di ricarica a contatto
multipla 6 posti
Multi-contact charging base
6 slots
LD0350RP



Poldina micro
Base di ricarica a contatto
multipla 12 posti
Multi-contact charging base
12 slots
LD0490RP



Amelie, Circe, Ofelia micro,
Olivia micro
Base di ricarica a contatto
multipla 6 posti
Multi-contact charging base
6 slots
LD0870RP

Accessori e ricambi

Accessories and spare parts



Amelie collection
Base di ricarica a contatto
Contact charging base
LD1090RB



Super O collection
Disco per ricarica a contatto
Contact charging puck
LD1060RB



Circe table lamp
Base di ricarica a contatto
Contact charging base
LD1005RB



Ofelia micro
Base di ricarica a contatto
Contact charging base
LD1880RB



Olivia micro
Base di ricarica a contatto
Contact charging base
LD1840RB



Sister Light collection
Base di ricarica a contatto
Contact charging base
LD1080RB



Sister Light table lamp
Adattatore per base di ricarica
Charging base adapter
LD1080BS



Pina
Base di ricarica a contatto
Contact charging base
LD0650RB



Poldina table lamp
Base di ricarica a contatto
Contact charging base
LD0350RB



Poldina micro
Base di ricarica a contatto
Contact charging base
LD0490RB



Poldina suspension lamp,
Poldina wall lamp,
Poldina lamp with peg
Base di ricarica a contatto
Contact charging base
LD0688RB

Base di ricarica a contatto multipla (max 6 posti)

Multi-contact charging base (max 6 slots)

→ Poldina (table lamp), Pina



→ LD0350RP

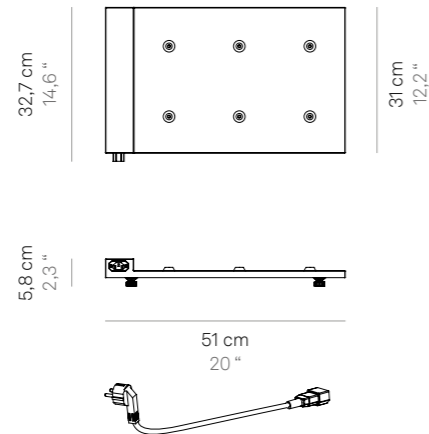

35W
INPUT: AC 100-240V | 50-60Hz
OUTPUT: 5Vdc max 6A

Base di ricarica a contatto multipla (max 6 posti) e modulare: più basi possono essere collegate in sequenza per caricare contemporaneamente più lampade. Particolarmente adatto all'uso professionale. Modular multi-contact (max 6 slots) charging base: they can be connected in sequence to simultaneously charge multiple set of lamps. Particularly suitable for professional use.

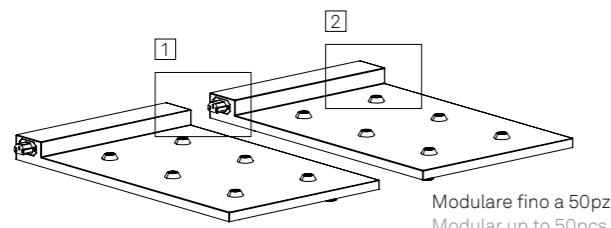
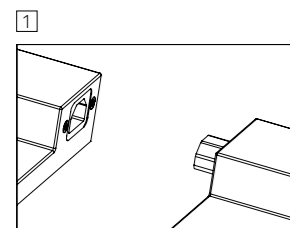

Modulare fino a 50pz
Modular up to 50pcs

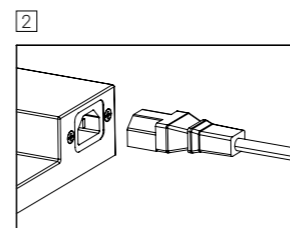
**Base di ricarica a contatto multipla (max 12 posti)**

Multi-contact charging base (max 12 slots)

→ Poldina micro



→ LD0490RP

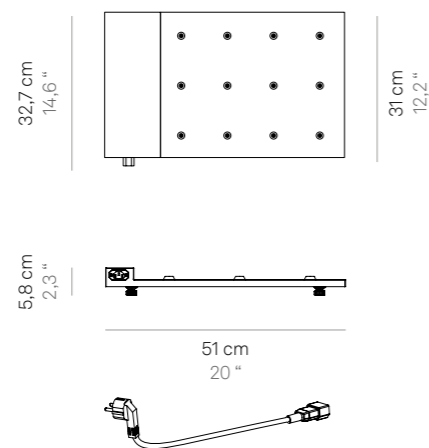

35W
INPUT: AC 100-240V | 50-60Hz
OUTPUT: 5Vdc max 12A

Base di ricarica a contatto multipla (max 12 posti) e modulare: più basi possono essere collegate in sequenza per caricare contemporaneamente più lampade. Particolarmente adatto all'uso professionale. Modular multi-contact (max 12 slots) charging base: they can be connected in sequence to simultaneously charge multiple set of lamps. Particularly suitable for professional use.

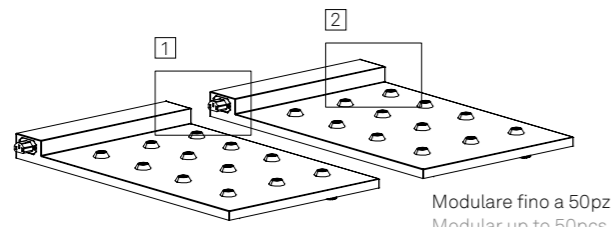
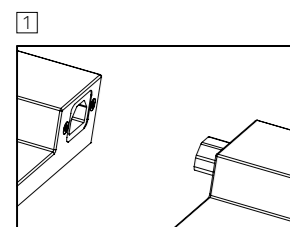

Modulare fino a 50pz
Modular up to 50pcs

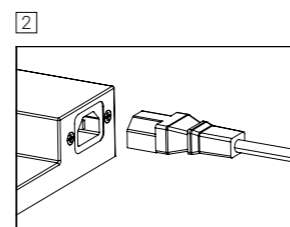
**Base di ricarica a contatto multipla (max 6 posti)**

Multi-contact charging base (max 6 slots)

→ Amelie, Circe, Olivia micro, Ofelia micro



→ LD0870RP

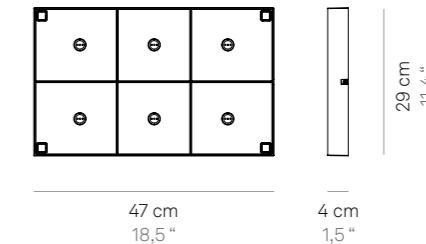

45W
INPUT: AC 100-240V | 50-60Hz
OUTPUT: 9Vdc max 5A

Base di ricarica a contatto multipla (max 6 posti) e modulare: più basi possono essere impilate (fino a max 3 livelli) per caricare contemporaneamente più lampade. Particolarmente adatto all'uso professionale. Modular multi-contact (max 6 slots) charging base: they can be stacked (up to max 3 levels) to simultaneously charge multiple set of lamps. Particularly suitable for professional use.

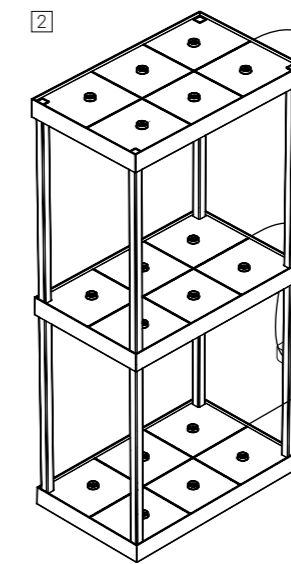
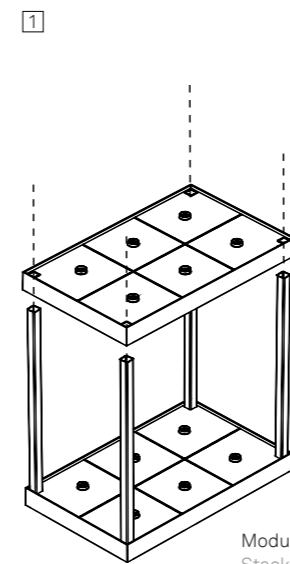

Modulare fino a 3 livelli.
Stackable up to 3 levels.

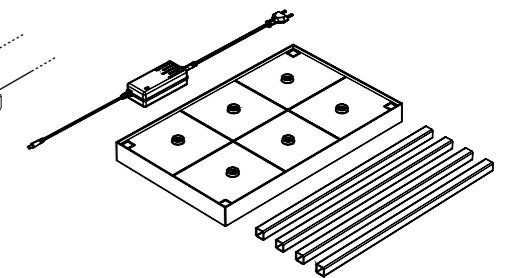
**Caricatore multiplo 8 prese USB**

8 x USB ports multi charger



→ LD0340RA

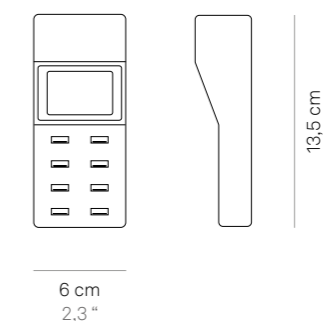

40W
INPUT: AC 100-240V | 50-60Hz
OUTPUT: 5Vdc - max 8A (8 pcs.)

Caricatore multipresa USB (8 x USB-A). Permette la carica di max 8 dispositivi contemporaneamente. Un display mostra graficamente il livello delle batterie in ricarica. Particolarmente adatto all'uso professionale. USB multi-socket charger (8 x USB-A). Can charge of up to 8 devices simultaneously. A graphic display shows the level of the batteries being charged. Particularly suitable for professional use.

Batterie ricaricabili

Rechargeable batteries

Le batterie ricaricabili sono soggette ad usura. La vita delle batterie, il cui standard è di circa 450 ricariche, può essere ridotta da alcuni fattori come: ① la modalità non corretta di ricarica (la lampada va ricaricata quando è scarica: circa il 10% della sua autonomia residua); ② lunghi periodi di stazionamento senza utilizzo; ③ lunghi periodi di stazionamento su base di ricarica in tensione anche se la lampada risulta carica; ④ l'utilizzo di accessori non originali per la ricarica; ⑤ l'esposizione del prodotto a temperature molto alte o molto fredde. Quando le lampade non si ricaricano più o l'autonomia risulta molto ridotta, le batterie devono essere sostituite. I ricambi delle lampade ricaricabili Zafferano sono disponibili a catalogo e identificati con apposito codice. La garanzia sulle batterie è valida solo per difetti di fabbricazione, che si manifestano al primo utilizzo.

All rechargeable batteries are subject to wear when used. The life of batteries, which can generally be recharged 450 times, may be reduced by certain factors: ① incorrect recharging mode (the lamp must be recharged when it is flat: about 10% of its remaining autonomy); ② when left unused for a long time; ③ when left for a long time on a live recharging base even if the lamp is recharged; ④ when non-original accessories are used for recharging; ⑤ when the product is exposed to very high or very low temperatures. When the lamps no longer recharge or their autonomy after recharging is very short, the batteries must be replaced. Spare parts for Zafferano rechargeable lamps can be found in the catalogue and identified by a special code. The warranty for batteries is only valid for manufacturing defects, if occurred at first use.

BAT04701906701900
Pacco batteria sostitutiva singola (necessari 2 pz. per **Pina, Home Solar**)
Single replacement battery pack (x2 pcs. needed for **Pina table lamp, Home Solar**)

3,7V | 1x2200mA/H



BAT04704004001000
Pacco batteria sostitutiva singola (necessario 1 pz. per **Poldina micro**)
Single replacement battery pack (1 pc. needed for **Poldina micro table lamp**)

3,7V | 1x1900mA/H



BAT04709003005000
Pacco batteria sostitutiva doppia (necessario 1 pz. per **Ofelia micro, Olivia micro**)
Double replacement battery pack (1 pc. needed for **Ofelia micro table lamp, Olivia micro table lamp**)

3,7V | 2x1500mA/H



Video tutorial / Tutorial video
sostituzione batterie
battery replacement

BAT04703706701900
Pacco batteria sostitutiva doppia (necessario 1 pz. per **Amelie, Circe, Poldina tavolo, Poldina picchetto, Poldina sospensione, Poldina parete**)
Double replacement battery pack (1 pc. needed for **Amelie, Circe, Poldina table lamp, Poldina lamp with peg, Poldina suspension lamp, Poldina wall lamp**)

3,7V | 2x2200mA/H



BAT04703706701901
Pacco batteria sostitutiva doppia (necessario 2 pz. per **Super O**)
Double replacement battery pack (2 pcs. needed for **Super O**)

3,7V | 2x2500mA/H



BAT04705506701900
Pacco batteria sostitutiva tripla (necessario 1 pz. per **Sister Light tavolo, Sister Light mini tavolo, Sister Light picchetto, Sister Light parete**)
Triple replacement battery pack (x1 pc. needed for **Sister Light table lamp, Sister Light mini table lamp, Sister Light lamp with peg, Sister Light wall lamp**)

3,7V | 7500mA/H





CE
 Dichiaro che il prodotto soddisfa gli standard dell'UE per la salute, la sicurezza e la protezione ambientale.
 Declares that the product meets EU standards for health, safety, and environmental protection.



CLASS II
 Apparecchio dotato di doppio isolamento e/o isolamento rinforzato in ogni parte e senza dispositivo di messa a terra.
 Light fitting equipped with double isolation and/or isolation reinforced in every part and without earthing device.



CLASS III
 Apparecchio basato su un'alimentazione a bassissima tensione di sicurezza, in cui non si producono tensioni superiori alla stessa.
 Light fitting based on a very low safety voltage power supply, in which no tensions higher than the same are produced.



IP PROTECTION DEGREE
 IP20: apparecchio protetto dalla penetrazione di corpi solidi di dimensioni maggiori a 12mm e non protetto dai liquidi.
 IP54: apparecchio protetto da polveri e da spruzzi d'acqua.
 IP65: apparecchio fortemente protetto da polveri e da getti d'acqua.
 IP20: protected from the penetration of solid objects greater than 12 mm and non protected from liquids.
 IP54: protected from dust and splashing water.
 IP65: highly protected from dust and water jets.



DIMMABLE
 Indica che è possibile regolare l'intensità luminosa della lampada.
 Indicates that the light intensity of the lamp can be adjusted.

Headquarters
Zafferano SRL
 Viale dell'industria 26
 31055 Quinto di Treviso (TV), Italy
 T +39 0422 470507
 F +39 0422 470400
 vendite@zafferanoitalia.com

Subsidiary
Zafferano America LLC
 301 Penhorn Avenue
 Suite 5,
 Secaucus, NJ 07094
 T +1 888 744 5277
 info@zafferanoamerica.com

Stores
Zafferano Store Treviso
 Viale dell'Industria, 26
 Quinto di Treviso (Italy)

Zafferano Store Milano
 Via Fatebenefratelli, 23
 Milan (Italy)

Zafferano Store New York
 121 Varick Street
 New York, NY 10013 (USA)

Art Direction, Graphic Design
 Zafferano Design
 © Copyright Zafferano SRL

Printing
 L'Artegrafica
 December 2023

NEWLAP24-01

L'azienda si riserva di apportare modifiche e/o migliorie di carattere tecnico ed estetico ai propri modelli e prodotti in qualsiasi momento e senza preavviso.
 The company reserves the right to make modifications and improvements of a technical or aesthetic nature to the products at any time without notice.

Il prodotto è protetto da garanzia, a norma di legge.
 The product is covered by a warranty, according to the law.