

Nouvelle

# Collection

Edition 2024



SONO LYS



# Découpe et gravure

Laser cutting and engraving.

*Laser*



# Impression

*Transfert*

Dye sublimation print

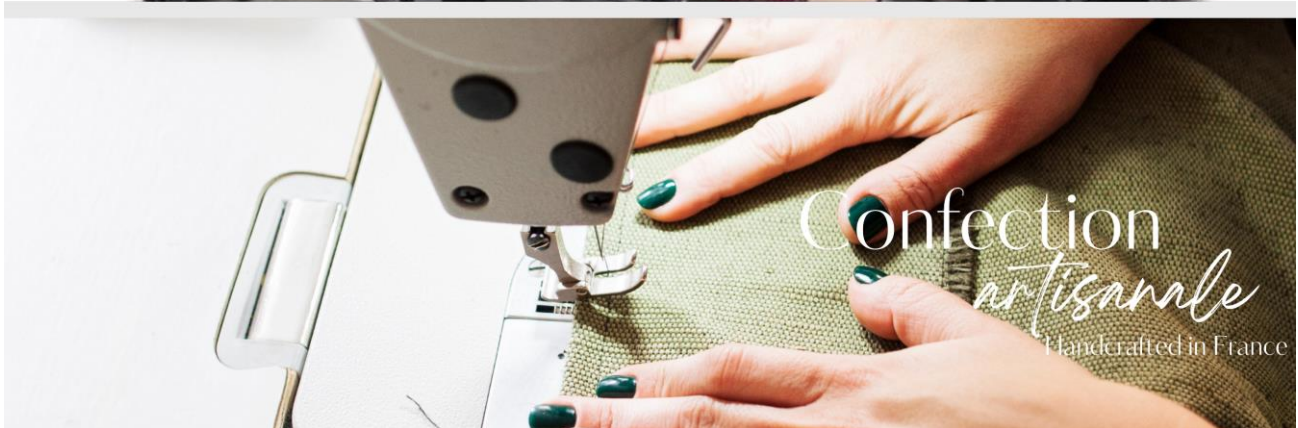

# Confection

*artisanale*

Handcrafted in France

04

Gammes PVC

Sonoclean, Sonoskaï, Sonotan, Pampa

---

11

Sets - Duos - Tapis de table - Sets Enfants

Placemats - Duos - Table mats - Kids placemats

---

21

Panières - Panières Buffet - Fonds de panières

Baskets - Buffet baskets - Basket bottom

---

35

Accessoires de table

Table accessories

---

45

Personnalisation

Customisation

---

47

Nappage - Protège-table - Juponnage

Tablecloths - Table protector - Skirting

---

65

Serviettes - Liteaux - Maniques - Bavoirs

Napkins - Bottle napkins - Potholder - Bibs

---

75

Ameublement Textile

Textile furnishing

---

86

Housses & galettes de chaise

Chair cover

---

89

Tabliers

Aprons

---

SOMMAIRE

# Les matières PVC Pour sets, panières, accessoires de table / For placemats, baskets, table accessories



Tiss Terracotta (TITR)



Tiss Beige (TIBG)



Tiss Azur (TIAZ)



Transat (TRAN)



Tiss Taupe (TITP)



Tiss Chocolat (TICC)



Tiss Saugé (TISG)



Tiss Moutarde (TIMT)



Rayé (RAYU)



Tiss Blanc (TIBC)



Tiss Gris (TIGR)



Tiss Acier (TIAC)

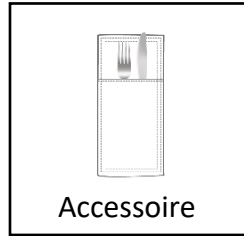
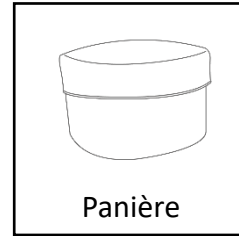
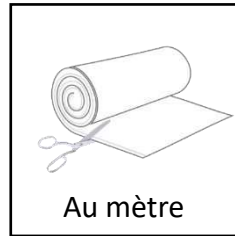
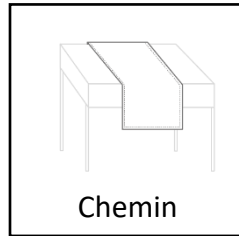
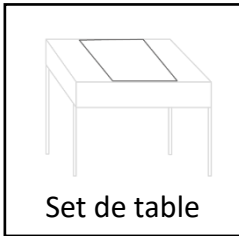
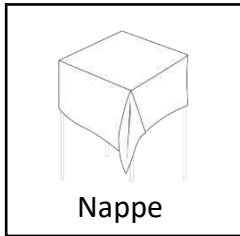

Carreaux Noir (CANR)



Interior Gris (INGR)



Carreaux Rouge (CARG)



Interior Rouge (INRG)



Osier Acier-Blanc (OS-ACBC)



Osier Camel-Vanille (OS-CMVN)



Tiss Noir (TINR)

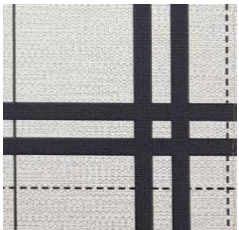

Torchon Noir (TCNR)



Tiss Rouge (TIRG)



Torchon Rouge (TCRG)



Osier Acier (OSAC)



Osier Camel (OSCM)

# Gamme SONOCLEAN

- 100% PVC effet tissu ou cuir
- Lavable à l'éponge
- Largeur 140 cm - 550gr/m2
- Lavable en machine à laver 30°C
- Imperméable
- Sans repassage

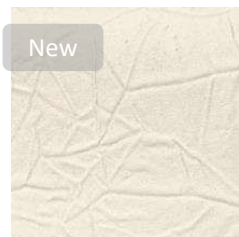

Kraft Blanc (KRBC)



Vintage Grège (VIGG)



Vintage Camel (VICM)



Vintage Cacao (VICC)



Vintage Ardoise (VIAR)



Cottage Beige (COBG)



Kraft Naturel (KRNT)



Paillette Or (PLOR)



Paillette Argent (PLAG)



Paillette Bronze (PLBZ)



Western Vanille (WEVN)

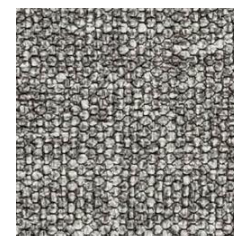

Cottage Gris (COGR)



Rotin (ROTI)



Jean Beige (JEBG)

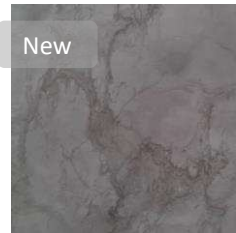

Stone Gris (STGR)

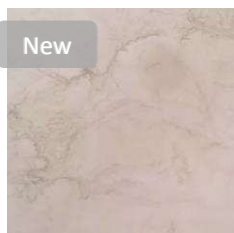

Stone Beige (STBG)



Vache (VACH)

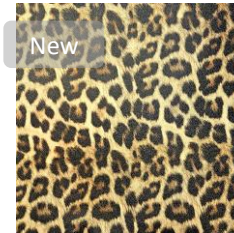

Leopard (LEOP)

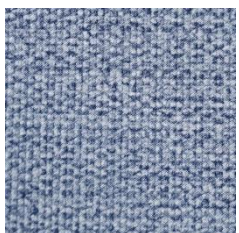

Jean Bleu (JEBL)

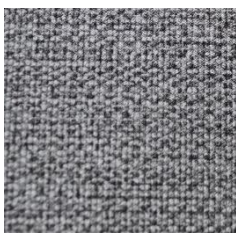

Jean Gris (JEGR)



Liège Bouchon (LGBC)



Crin Noir (CRNR)



Jean Blanc (JEBC)



Interior Bleu (INBL)

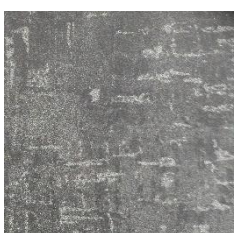

Liège Carbone (LGCB)



Crin Taupe (CRTP)



## ON ADORE:

- ✓ Réutilisable
- ✓ Vrai effet tissu ou cuir
- ✓ Utilisation intérieur/extérieur (terrasse ombragée)

# Les matières PVC

Pour sets, panières, accessoires de table / For placemats, baskets, table accessories

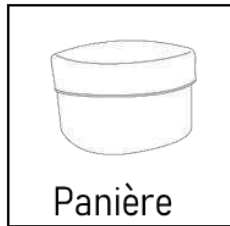
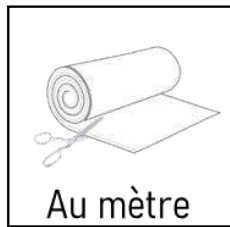
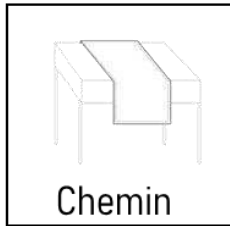
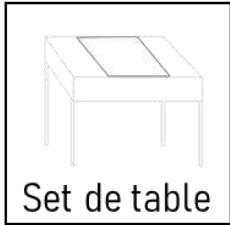
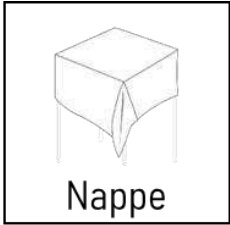

# Gamme SONOSKAÏ

- 100% PVC effet cuir grainé
- Largeur 140 cm - 400gr/m<sup>2</sup>
- Lavable à l'éponge
- Lavable en machine à laver 30°C (1 à 2 fois par mois)
- Imperméable
- Sans repassage



Noir (SINR)



Souris (SISR)

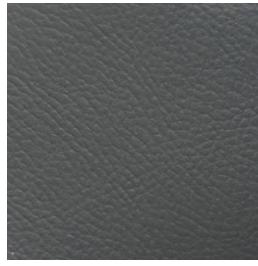

Ardoise (SIAR)



Daim (SIDM)



Rouge (SIRG)

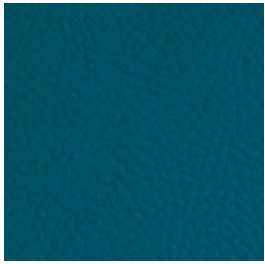

Paon (SIPN)



Bordeaux (SIBX)



Kaki (SIKK)



Curcuma (SICR)



Gold (SIGD)



New

Brume (SIBM)



New

Brique (SIBQ)



Taupe (SITP)



New

Mastic (SIMA)

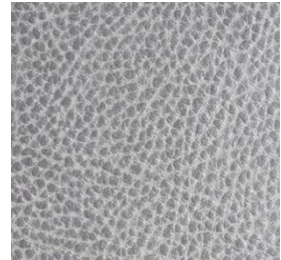

Argent (SIAG)



## ON ADORE:

- ✓ VEGAN et réutilisable
- ✓ Effet cuir grainé
- ✓ Désinfection facile et rapide
- ✓ Utilisation intérieur et extérieur (terrasse ombragée)

*VEGAN and reusable  
Grained leather effect  
Quick and easy to disinfect  
Indoor and outdoor use (shaded terrace)*



New

Copper (SICO)

# Gamme SONOTAN

- Cuir synthétique / *Synthetic leather*: 86% PVC - 12% Polyester - 2% Polyurethane
- Largeur / *Width*: 140 cm - Poids / *Weight*: 950gr/m<sup>2</sup>
- Pour sets, panières, accessoires de table / *For placemats, baskets, table accessories*



Camel (TACM)



Marine / Navy (TAMN)



Rouge / Red (TARG)



Argent / Silver (TAAG)

## ON ADORE:

- |                                 |                                       |
|---------------------------------|---------------------------------------|
| ✓ <b>VEGAN et réutilisable</b>  | ✓ <i>VEGAN and reusable</i>           |
| ✓ <b>Effet vrai cuir épais</b>  | ✓ <i>Thick genuine leather effect</i> |
| ✓ <b>Imperméable</b>            | ✓ <i>Waterproof</i>                   |
| ✓ <b>Antidérapant</b>           | ✓ <i>Non-slip</i>                     |
| ✓ <b>Lavable à l'éponge</b>     | ✓ <i>Sponge-washable</i>              |
| ✓ <b>Machine à laver à 30°C</b> | ✓ <i>Machine washable at 30°C</i>     |



Noir / Black (TANR)

**Découpe laser sur-mesure**  
**Finition de haute qualité**  
**Surpiqûre au fil épais**

*Custom laser-cutting*  
*High-quality finishing*  
*Thick thread topstitching*

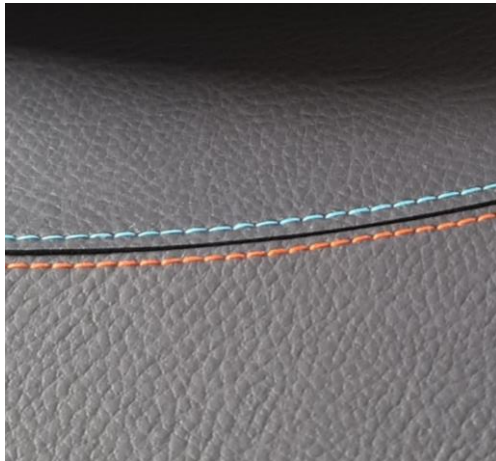

Surpiqûre de couleur possible.  
*Colored stitching available.*



Matière idéale pour la gravure laser  
*Ideal material for laser engraving*



Option poinçon (en supplément)  
*Punch option (extra charge)*



# Gamme *Pampa*

## COLORIS



Ecreu



Paille



Chocolat



Gris

Idéal pour paniers et sets de table  
*Ideal for baskets and placemats*

- 100% Polypropylène effet paille tressée  
*Polypropylene braided straw effect.*
- Lavable à 40°C, Essorage 800T/mn  
Retrait +/- 4% après 1er lavage

*Washable at 40°C, Spin 800 rpm  
Shrink +/- 4% after 1st wash*

- Résistant & réutilisable  
*Strong & reusable*



# Sets, Duos, Tapis *1 face ou 2 faces*

Placemats, Duos, Table mats



# Les sets

## Placemats

Les formes  
*The shapes*

p. 12

Collection Insolites  
*Unusual placemats*

p. 14

Collection Enfant  
*Kids' placemats*

p. 15

Sets double-utilisation  
*Double-use placemats*

p. 16

Collection Pochoirs

p. 19



# Les formes de SET DE TABLE (toutes tailles et toutes formes, découpes spéciales sur devis)



## Placemats shapes

1 face ou 2 faces, coloris au choix: gammes Sonoclean, Sonoskaï, Sonotan

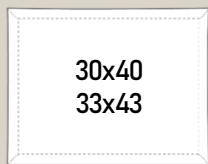

Rectangle



Rond

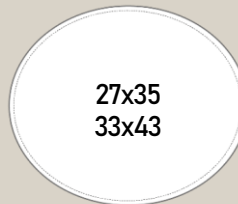

Ovale

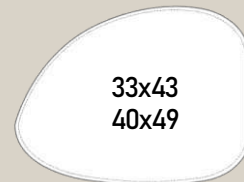

Ovoïde

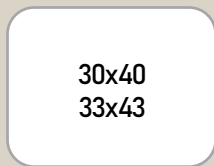

Coins arrondis



Carré

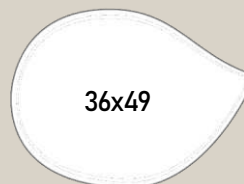

Goutte



Galet



Tâche

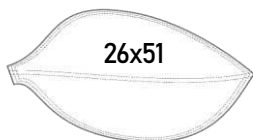

Feuille



Tanneur



Coeur

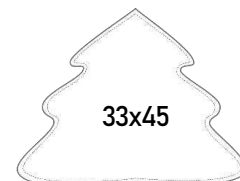

Sapin

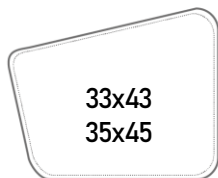

Asymmetric

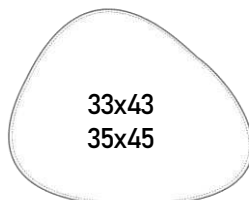

Triangle

New

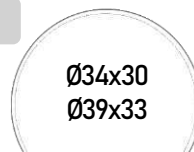

Sphere

New

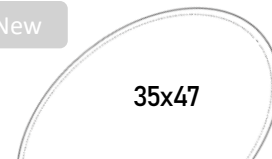

Oblong

New



Trapèze



Diamant

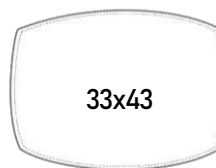

Ecran

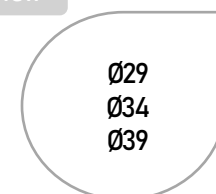

Quart



# Sets Placemats

PERSONNALISABLES  
CUSTOMIZABLE

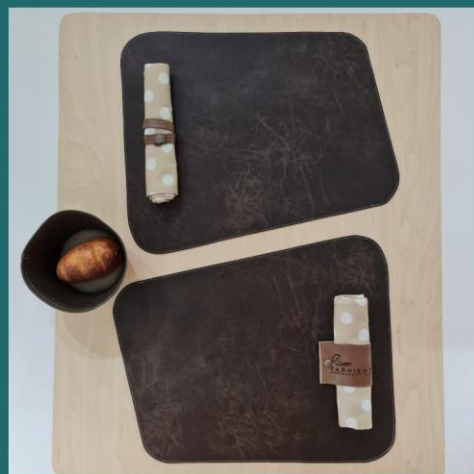

# Collection Insolite

## Sets de table



**Cerf** - l:46 x H:33cm



**Vache**- 38x38cm



**Buffle** - l:45 x H:33cm



**Poule** - l:48 x H:33cm

PVC imperméable / Waterproof  
Lavable à l'éponge et machine 40°C  
Sponge-wash and washing machine

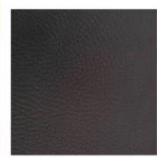

Sonotan Noir



Sonotan Camel



Sonotan Rouge



Sonotan Marine



Sonotan Argent



**Bulle** - l:45 x H:33cm



**Némo** - l:50 x H:25cm



# Set de table *Enfant*



Kids placemats

Coloris/Colors: SONOCLEAN, SONOSKAI, SONOTAN

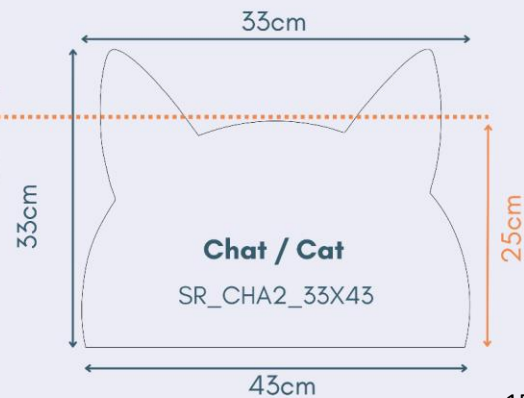
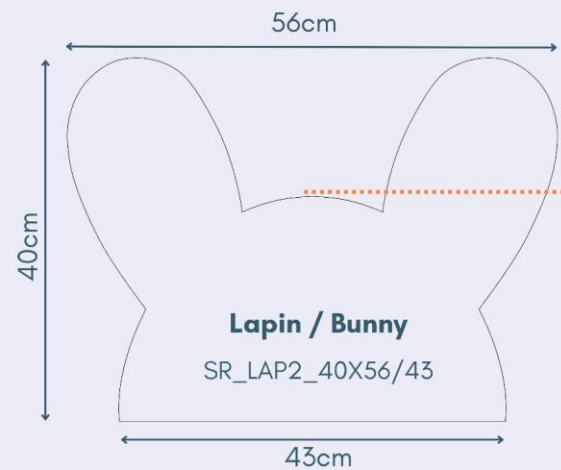

# Combinaisons Matières/Finitions

Material/Finish combinations

Set / Placemat Finition / Finish	1 face Tarif A	1 face Tarif B	2 faces réversible Tarif C	2 faces réversible Tarif D
Coupe Laser <i>Laser cut</i>		SONOTAN	SONOCLEAN/SONOCLEAN SONOCLEAN/SONOSKAÏ SONOSKAÏ/SONOSKAÏ	SONOTAN / SONOTAN
Surpiqûre <i>Topstitching</i>		SONOTAN	SONOCLEAN/SONOCLEAN SONOCLEAN/SONOSKAÏ SONOSKAÏ/SONOSKAÏ	SONOTAN/SONOTAN SONOTAN/SONOSKAÏ SONOTAN/SONOCLEAN
Ourlet ou bourdon <i>Hem or bourdon stitch</i>	MATIERE TEXTILE JUTE SONOCLEAN SONOSKAÏ	SONOSUN PAMPA		SONOTAN / JUTE SONOTAN / MATIERE TEXTILE SONOTAN / PAMPA

## Sets double utilisation

1 face ou 2 faces, coloris au choix: gammes Sonoclean , Sonoskaï, Sonotan

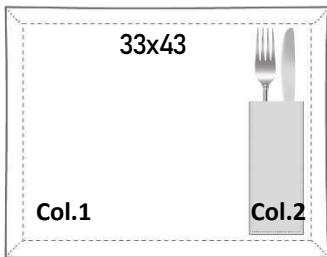

À poche

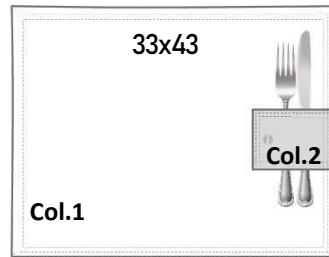

À languette

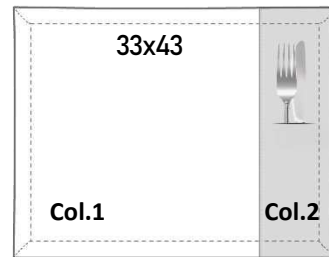

Etui

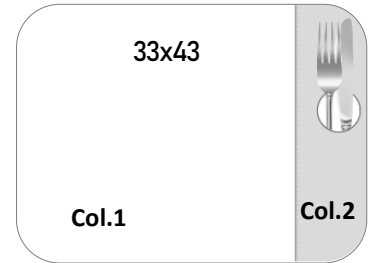

Hublot

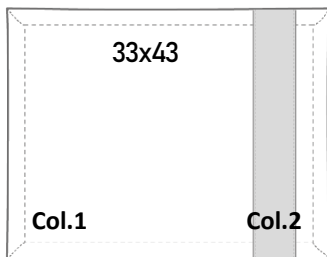

Bandeau

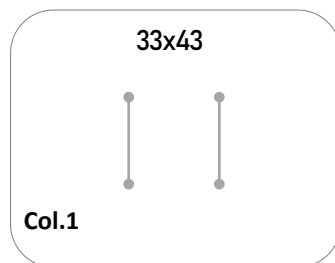

Accueil

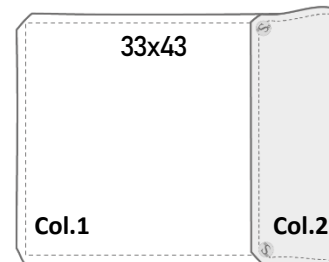

À soufflet

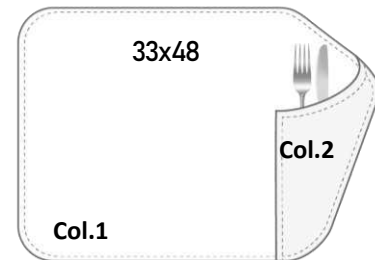

Cornet





Sets double  
utilisation  
Double use  
placemats

PERSONNALISABLES  
CUSTOMIZABLE



# Set de table *Accueil*

Fentes ou bandeau à réaliser  
sur toute forme de set.  
*Slots or headband to be made  
on any shape of placemat.*



Personnalisation gravure laser  
*Laser engraving customization*

# Collection Pochoirs

*Paniers, sets, porte-couverts*



Panière Pot Carré  
10x10x11cm



Cœur Rouge



Sapin Rouge



Etoile Rouge



Cœur Camel



Sapin Camel



Etoile Camel

- Découpe de formes à la machine laser
- Coloris au choix: voir gammes Sonoclean, Sonoskaï, Sonotan



Porte-couverts  
10x24cm

# Mix & Match *au gré de vos envies*



# Les panières

## Baskets

Les formes  
*The shapes*

p. 22-25

Panière Brot

p. 26

Collection Jute

p. 27

Panière Buffet-Pampa

p. 28

Collection Jersey

p. 29

Collection Peluche

p. 30

Collection Crin

p. 31

Panière Montagnarde

p. 32

Les fonds de panières  
*Basket bottoms*

p. 33



# Les formes de Panières

## Basket shapes

à réaliser dans les matières PVC: Sonoclean, Sonoskaï, Sonotan, Sonosun, Pampa  
Et les gammes TEXTILE: Sonojean, Jute, etc.

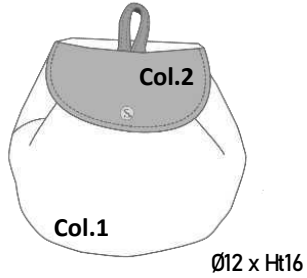

Borsalino

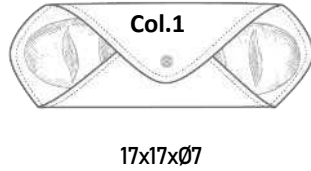

Baguettine

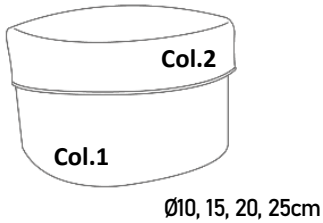

Ronde

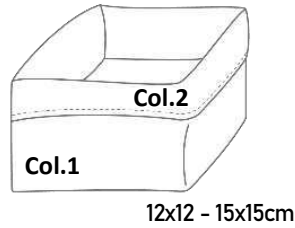

Carrée

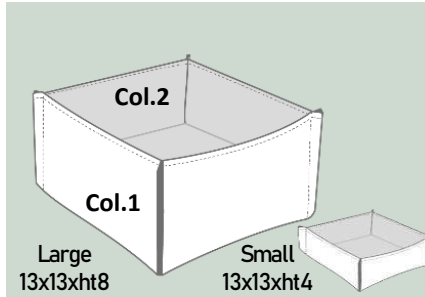

Barket

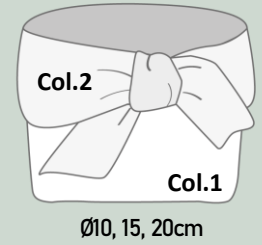

Nœud

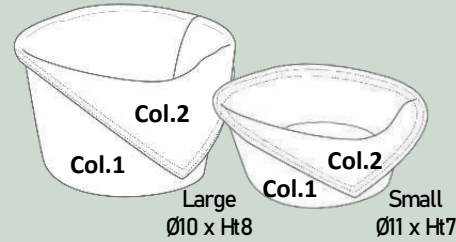

Bandana

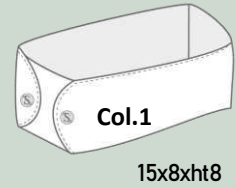

Oslo

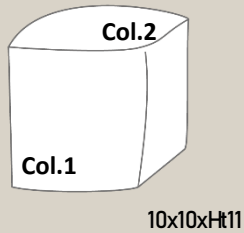

Pot carré

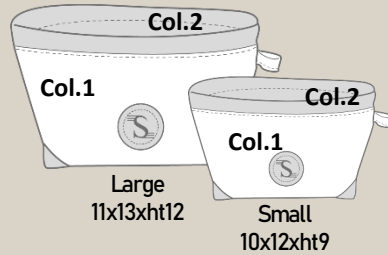

Ecrin

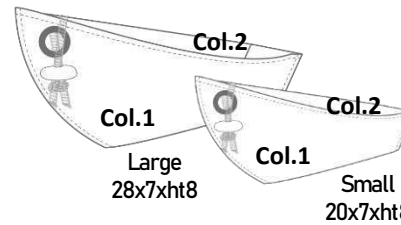

Bateau

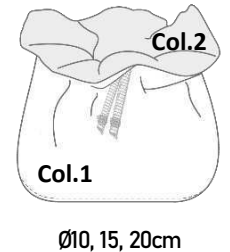

Bonbon

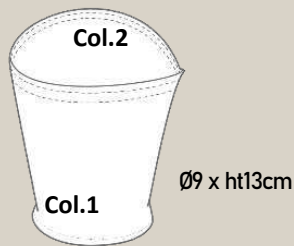

Cornet

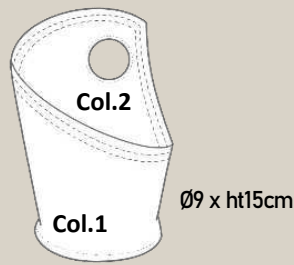

Hublot

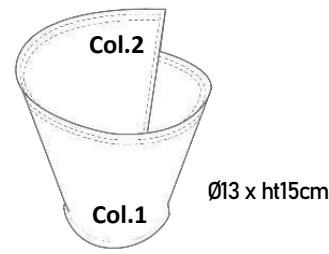

Biseau

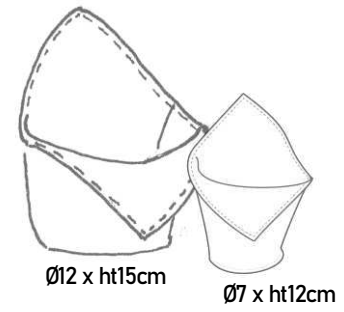

Bicorne Domette

# Les Pannières



Borsalino



Baguettine



Barket (Grand, Petit)



Nœud



Ronde (Ø10, 15, 20, 25cm)



Carrée (12x12, 15x15cm)



Bandana (Grand, Petit)



Oslo



Pot carré



Ecrin



Bateau (Grand, Petit)



Bonbon



Cornet



Hublot



Biseau



Bicorne Dosette

# Les formes de Panières

à réaliser dans les matières PVC: Sonoclean, Sonoskaï, Sonotan, Sonosun, Pampa  
Et les gammes TEXTILE: Sonojean, Jute, etc.

## Basket shapes

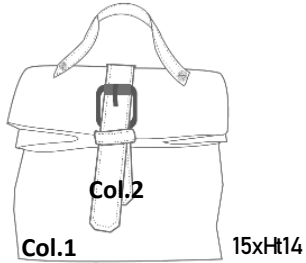

Sacoche

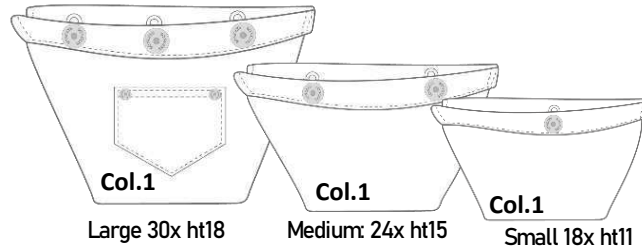

Trousse (Grand, Moyen, Petit)

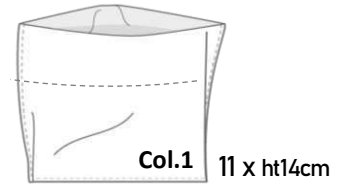

Faro

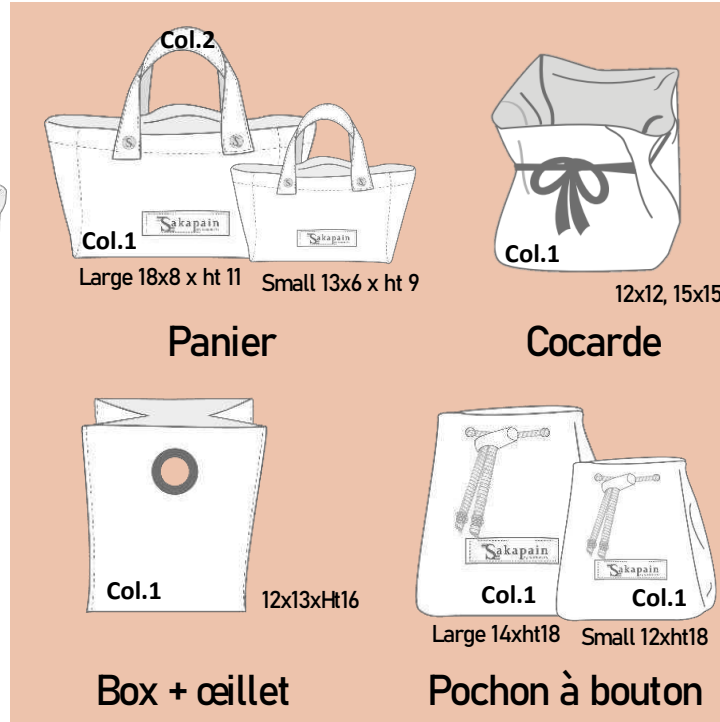
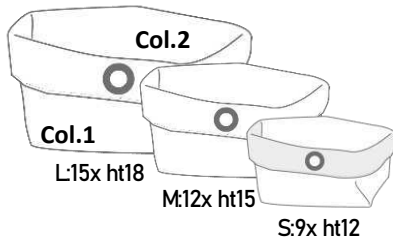

Panier

Cocarde

Sakado

À œillet 1 ou 2 couleurs

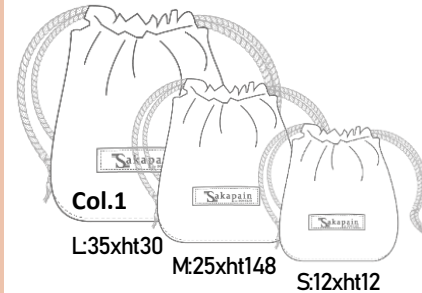
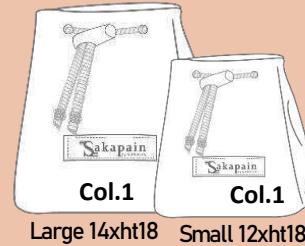
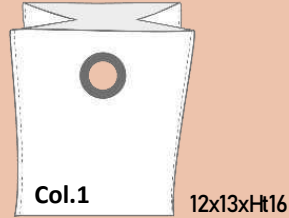
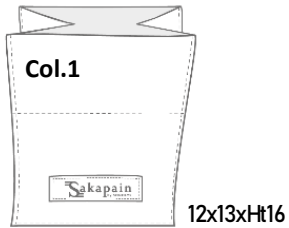

Box + étiquette

Box + œillet

Pochon à bouton

Pochon à lacets

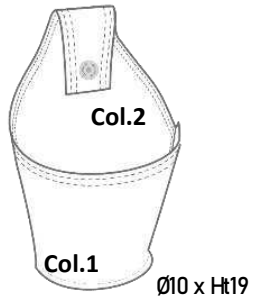

Seau

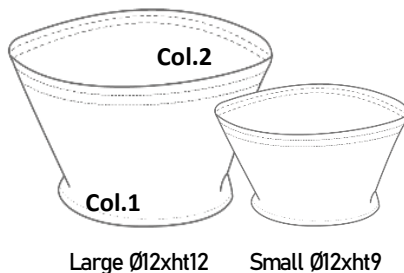

Coupelle

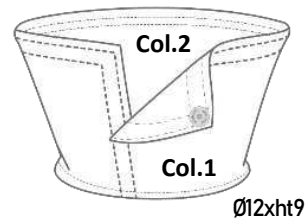

Soucoupe

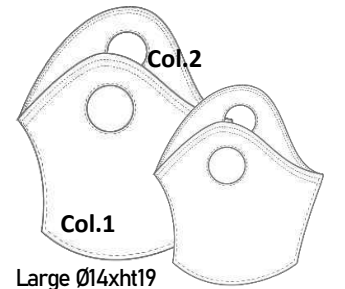

Bag



# Les Pannières



Sacoche



Trousse (Grand, Moyen, Petit)



Faro



À œillet (Grand, Moyen, Petit)



Panier (Grand, Petit)



Cocarde



Sakado



Box + étiquette



Box + œillet



Pochon à bouton



Pochon à lacets



Seau



Coupelle (Grand, Petit)



Soucoupe



Bag

# Panière *Brot*



JUTE / SONOSKAÏ

# Collection Jute



**Panière Pochon Lacet Jute**

- Petit : 12x18cm
- Moyen: 25x18cm

Jute / Torchon MIF



Jute / Bistro

**Panière Pochon Lacet + Doublure**

- Petit : 12x18cm
- Moyen: 25x18cm



**Panière Pochon à bouton**

- Petit : 12x13cm
- Moyen : 14x15cm



**Panière Box+Etiquette**

Taille unique: 12x Ht 13cm



**Grande Trousse Jute**

Grand : 30x18cm



**Panière Trousse Jute ou Jute blanc**

- Petit : 18x11cm
- Moyen: 24x15cm



**Panier souple Jute**

- Petit: 13x6x Ht 9cm
- Grand: 18x8x Ht 11cm



**Panière Sakado**

TU: Ø13x Ht 15cm



**Panière Faro**

TU: 11x Ht 14cm



**Panier rigide Jute/Sonotan**

- Petit: 13x6x Ht 9cm
- Grand: 18x8x Ht 11cm



**Panière Cornet**

TU: Ø9 x Ht 13cm



**Panière Bicorne**

Petit: Ø12 x Ht 15cm



**Panière Jute / Sodenim Moutarde**

- Ø 10 / 15 / 20 / 25cm



**Panière Jute / Sodenim Taupe**

- Ø 10 / 15 / 20 / 25cm



**Panière Jute / Sodenim Kaki**

- Ø 10 / 15 / 20 / 25cm



**Jute / Sodenim Noir**

- Ø 10 / 15 / 20 / 25cm

## Spécial Buffet / Gamme Pampa



**Panière Faro 11x14cm**  
 Coloris: Pampa Ecu  
 Réf.: FAROP PAEC



**Panière 11x14cm**  
 Coloris: Pampa Paille  
 Réf.: FAROP PAPL



**Panière 11x14cm**  
 Coloris: Pampa Chocolat  
 Réf.: FAROP PACC



**Panière Faro 11x14cm**  
 Coloris: Pampa Gris  
 Réf.: FAROP PAGR



**Panière Ronde Ø30cm**  
 Coloris: Pampa Gris  
 Réf.: PSR D30 PAGR



**Panière Ronde Ø25cm**  
 Coloris: Pampa Chocolat  
 Réf.: PSR D25 PACC



**Panière Ronde Ø20cm**  
 Coloris: Pampa Paille  
 Réf.: PSR D20 PAPL



**Panière Ronde Ø15cm**  
 Coloris: Pampa Ecu  
 Réf.: PSR D15 PAEC



**Panière Bicorne Ø30cm**  
 Coloris: Pampa Ecu  
 Réf.: PSBI D30 PAEC



**Panière Bicorne Ø10cm**  
 Coloris: Pampa Paille  
 Réf.: PSBI D10 PAPL



**Grand Panier 8x18x11cm**  
 Coloris: Pampa Paille  
 Réf.: PNPA GRA PAPL



**Petit Panier 6x13x9cm**  
 Coloris: Pampa Paille  
 Réf.: PNPA PET PAPL



**Buffet Baguette 24x24x35cm**  
 Coloris: Pampa écu  
 Réf.: PSBFBG 24X24X35 PAEC



**Buffet Rectangle 25x35x15cm**  
 Coloris: Pampa Paille  
 Réf.: PSBF 25X35X15 PAPL



**Buffet Rectangle 15x25x15cm**  
 Coloris: Pampa écu  
 Réf.: PSBF 15X25X15 PAEC



**Buffet Carré 20x20x15cm**  
 Coloris: Pampa Paille  
 PSBF 20X20X15 PAPL

# Collection Jersey

## Paniers et porte-couverts



Cornet Jersey Gris /  
Sonotan Camel



Cornet Jersey Kaki /  
Sonotan Camel



Cornet Jersey Noir /  
Sonotan Camel



Cornet Jersey Beige /  
Sonotan Camel



Cornet Jersey Moutarde /  
Sonotan Camel



Coupelle Jersey Gris /  
Sonotan Camel



Coupelle Jersey Kaki /  
Sonotan Camel



Coupelle Jersey Noir /  
Sonotan Camel



Coupelle Jersey Beige /  
Sonotan Camel



Kaki



Gris



Moutarde

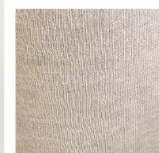

Beige



Noir

Etiquette personnalisable



Paniers



Panière rectangulaire



Porte-couverts

# Collection Peluche

## Paniers et porte-couverts



Poil Brun



Poil Blanc



Mouton  
Crème

**Extérieur** = Fourrure synthétique

**Intérieur** = PVC effet cuir, imperméable

Panière lavable à l'éponge.

*Exterior = synthetic fur*

*Inside = PVC fabric effect, waterproof*

*Sponge-washable basket*



Cornet Mouton Crème /  
Sonotan Camel



Panier Mouton Crème /  
Sonotan Camel



Coupelle Poil Brun /  
Sonotan Camel



Panier Poil Brun /  
Sonotan Camel



Porte-couverts  
Poil Brun



Porte-couverts  
Poil Blanc



Coupelle Poil Blanc /  
Sonotan Camel



Cornet Poil Blanc /  
Sonotan Camel



Panier Poil Blanc /  
Sonotan Camel

# Collection Crin

*Sets, paniers, accessoires*



Crin Noir



Crin Taupe



Pampa Choco



Pampa Gris



Panière Ø15cm  
Pampa Gris / Crin Noir



Panière Ø15cm  
Pampa Choco / Crin Taupe

Produits imperméables (Sonoclean/Pampa)  
Lavable à l'éponge

Waterproof products (Sonoclean /Pampa)  
*Sponge-washable*

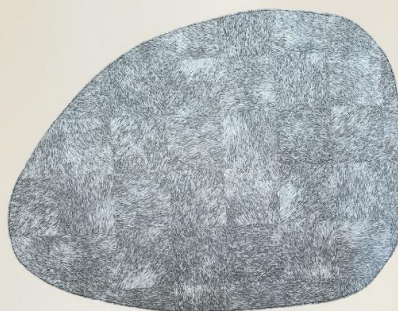

Set Ovoïde 2 faces 33x43  
Crin Noir



Set Ovoïde 2 faces 33x43  
Crin Taupe



Porte-couverts  
Pampa Gris / Crin Noir



Porte-couverts  
Pampa Choco / Crin Beige



Sous-verre



Etui à couverts



# Panière Montagnarde

*Croutons et pommes de terre*



Jute / Tiss Saugé (Sage)



Jute / Tiss Beige



Jute / Tiss Terracotta



Jute / Tiss Chocolat



Jute / Tiss Azur



Jute / Tiss Noir (Black)



Jute / Vache (Cow)



Jute / Tiss Blanc (White)



Jute / Tiss Taupe

Idéale pour les plats montagnards:  
à remplir avec des croutons  
de pains ou pommes de terre

Ø 15cm = 2 personnes  
Ø 20cm = 4 personnes  
Ø 25cm = 6 personnes

**Extérieur** = Jute naturelle  
**Intérieur** = PVC effet tissu, imperméable  
**Noeud décoratif** = polycoton  
Autres coloris: Sonoclean ou Sonoskaï.

Panière lavable à l'éponge.

*Exterior = natural jute  
Inside = PVC fabric effect, waterproof  
Decorative bow = polycotton  
Other colors: Sonoclean or Sonoskaï.*

*Sponge-washable basket*





100% Polyester:  
LINELYS ou MAGILYS

Anti-miettes  
*Holds bread crumbs*

Lavable à 30°C, 800T/mn  
Sans repassage

40x40cm

35x35cm

# Fonds *de paniers*



Carreau Rouge Carreau Noir Mosaïque Jaune



Damier Vert Damier Jaune Damier Gris Damier Rouge



Rayures Marine Romane Etoile



Linélys Vanille Fleurette Coco Beige



Palmier gris Uni Thym Exotic



Liberty Girafon Aubépine



Bambou Linélys Beige Palmier Beige



Pâquerette Uni Brique Big Night

# Accessoires de table

à réaliser dans les matières PVC: Sonoclean, Sonoskaï, Sonotan, Sonosun, Pampa  
Et les gammes TEXTILE: Sonojean, Jute, etc.

## Sous-verre

1 face

Ou 2 faces (réversible)



Rond



Carré



Tâche



Triangle

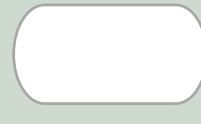

Duo



Ovoïde



Goutte

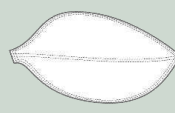

Feuille



Galet

## Porte-menu



A pression



A élastique

Roll



## N° de table

Chevalet



Porte-clé



N° de table

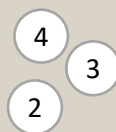

Mousqueton



## Porte-couverts



Cornet

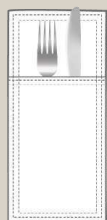

Classique



Etui



Roll

## Porte-addition



Pochette



Roll

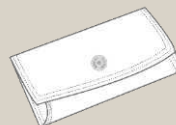

Portefeuille

## Rond de serviette



Bague



Manchette



Losange



Feuille



Pince



Ceinture



Spiral



Croisé

# Les accessoires

## Table accessories

Sous-verre  
*Coaster*

p. 36

Rond de serviette  
*Napkin ring*

p. 37

Porte-addition  
*Bill holder*

p. 38

Porte-couverts  
*Cutlery holder*

p. 39

Porte-lame  
*Knife holder*

p. 40

Porte-menu  
*Menu holder*

p. 41

N° de table & porte-clé  
*Table number & key ring*

p. 43





# Sous-verre *sous-boc*

Au choix / *Your choice:*  
1 face ou 2 faces

Coloris / *Colors:*

- Sonoclean
- Sonoskai
- Sonotan
- Jute

Lavable à l'éponge  
*Sponge washable*



Ø11  
Rond  
*Round*



11x11  
Carré  
*Square*



10x10  
Coins arrondis  
*Rounded corner*



20x11  
Oblong



20x11  
Duo

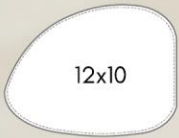

12x10  
Ovoïde



12x10  
Triangle

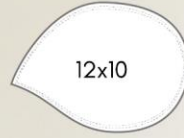

12x10  
Goutte  
*Drop*

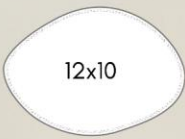

12x10  
Galet  
*Pebble*

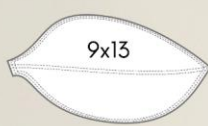

9x13  
Feuille  
*Leaf*



Ø12  
Tâche  
*Stain*

Ajoutez votre logo  
*Add your logo*





# Ronds *de serviettes*

Coloris / Colors:

- Sonoclean
- Sonoskaï
- Sonotan
- Jute
- Sonostyle
- Sonojean

Lavable à l'éponge  
*Sponge washable*



Bague



Feuille



Losange



Croisé

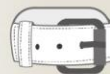

Ceinture



Spiral

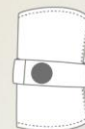

Manchette

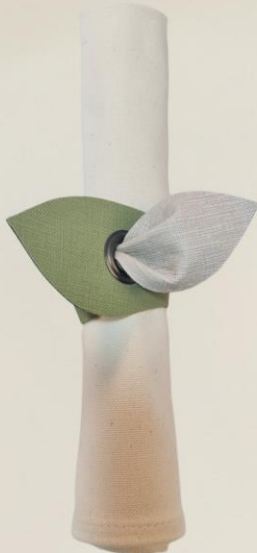



Au choix / Your choice:  
Unicolore ou bicolore

- Coloris / Colors:
- Sonoclean
  - Sonoskaï
  - Sonotan
  - Jute

Lavable à l'éponge  
Sponge washable

Tous nos produits sont personnalisables



**Ronde**  
Ø8 x Ht 6cm



**Assiette**  
Ø12 x Ht 3cm



**Corneto**  
Ø11 x Ht 10/6cm



**Pot**  
Ø10 x Ht 8cm



**Pointes**  
Ø7 x Ht 12cm



**Dosette**  
Ø7 x Ht 12cm



**Livret**  
15 x 8cm (fermé)  
15 x 16cm (ouvert)



**Roll**  
Ø6 x ht 18cm (fermé)  
18 x 25cm (ouvert)



**Portefeuille**  
1.8 x L. 15cm (fermé)  
1.15 x L. 25cm (ouvert)



**Pochette**  
1.10 x L. 15cm

# Porte-couverts *Etui, pochette*



Au choix / *Your choice:*  
Unicolore ou bicolore

Coloris / *Colors:*

- Sonoclean
- Sonoskai
- Sonotan
- Jute

Lavable à l'éponge  
*Sponge washable*



Classique



Cornet



Enveloppe à  
pression



Set à couverts



Pochette à  
baguettes



Roll à couverts



Etui à couverts





Au choix / Your choice:  
Unicolore ou bicolore

- Coloris / Colors:
- Sonoclean
  - Sonoskaï
  - Sonotan

100% PVC, similicuir  
Synthetic leather

Lavable à l'éponge  
Sponge washable

# Porte-lame *de couteaux*



Sonotan Noir



Sonotan Rouge



Sonotan Marine



Sonotan Camel



Sonotan Argent

Taille 1  
Size



Confection sur-mesure  
Made-to-measure

Taille 2  
Size





Au choix / Your choice:  
Unicolore ou bicolore

Coloris / Colors:

- Sonoclean
- Sonoskaï
- Sonotan

100% PVC, similicuir  
Synthetic leather

Lavable à l'éponge  
Sponge washable

# Porte- menu

BRASSERIE  
**DUFOUR**  
Cuisine française

A4

A5



Option:  
Languette

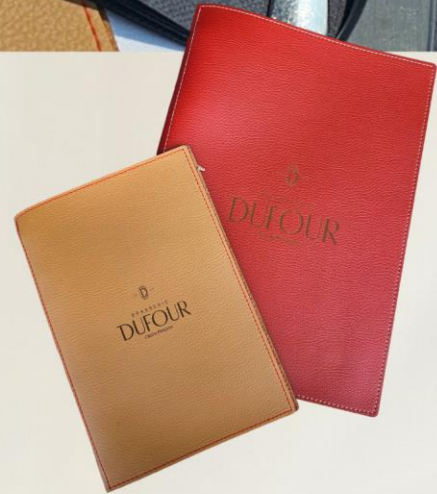

## Modèle Pressions



Option logo:  
gravure laser ou  
sérigraphie couleur

## Modèle Elastiqué

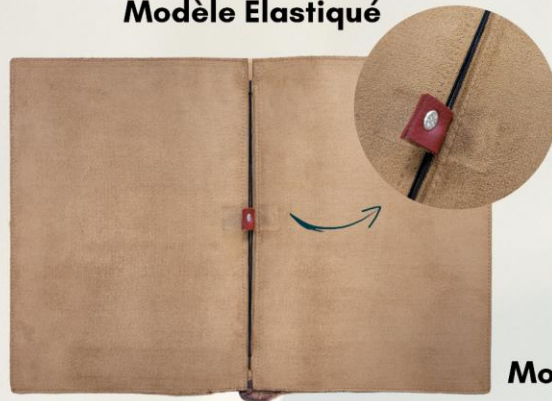

Pochettes  
plastifiées à insérer  
(non fournies)



## Modèle Patte à vis



N° de table  
*personnalisable*



N° de table  
Ø6cm  
Découpe laser



# N° de table et porte-clés

Coloris / Colors:

- Sonoclean
- Sonoskai
- Sonotan
- Jute
- Sonojean
- Sodenim



Porte-clés:



Cœur



Poisson



Pochon



Label



Pyramide



Sac



Coussin  
Gamme Linélys



Chevalet

Option:  
Anneau brisé ou mousqueton:



Porte-clés  
Rond Ø7cm

# Exemples de personnalisation *Examples of customization*

Réalisation de « Bon à tirer » à valider avant mise en production (logo vectorisé à fournir par le client)  
*Creation of printproof to be validated before going into production (vectorized logo to be supplied by customer)*

**B.A.T. MURTOLI**  
- 10/03/23 -

DOMAINE DE MURTOLI



Panier en Jute

Sangles SONOTAN CAMEL  
Sans surpiqûre

Étiquette ronde SONOTAN CAMEL Ø5cm  
Surpiqûre beige  
Logo gravure laser au centre

Étiquette Ø5cm

**B.A.T. L'ANVIE**  
- 06/03/23 -

55 x set Triangle surpiqûre inversée

- Gravure laser
- Logo largeur 8cm
- En bas à gauche suivant la courbe, côté STONE ARDOISE

Page 1/2

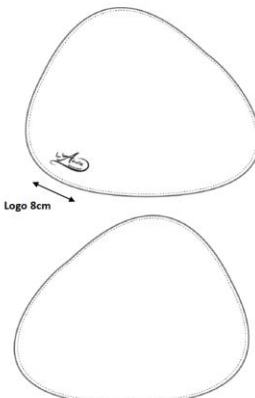

RECTO: STONE ARDOISE / Logo gravé  
Surpiqûre Terracotta

VERSO: TISS TERRACOTTA / Pas de logo  
Surpiqûre Ardoise

Logo 8cm

**BEEFØR**  
BUTCHERS & CHEFS

15 x Tablier GED



Haut + poche latérale + sangles  
Sonomixt Noir

Bas sonoskaï bordeaux

Logo sérigraphie 1 couleur

- Centré à gauche dessus la poche
- Couleur NOIR
- 8cm de large

**B.A.T. L'ANVIE**  
- 06/03/23 -

30 x porte-couverters Cornet

- Gravure laser
- Logo largeur 8cm
- En haut suivant la courbe, côté STONE ARDOISE

Page 2/2

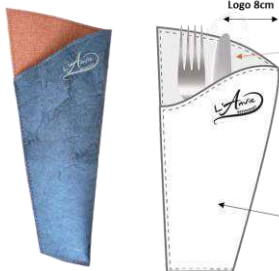

Intérieur: TISS TERRACOTTA / Pas de logo  
Surpiqûre Ardoise

Extérieur: STONE ARDOISE / Logo gravé  
Surpiqûre Terracotta

Logo 8cm



La Perso  
Customization

BRODERIE, LASER,  
SÉRIGRAPHIE



# Tapis de table *1 face ou 2 faces*



# Les nappes

## Tablecloths

Quel tissu choisir ?  
*Which fabric to choose?*

p. 48

Les finitions  
*Tablecloth finishings*

p. 49

Tissus Imperméables - PVC  
*Waterproof fabrics*

p. 50

Tissus imprimables - polyester  
*Printable fabrics*

p. 52

Tissus Atypiques - polyester  
*Atypical fabrics*

p. 56

Tissus Basiques - polycoton  
*Basic fabrics*

p. 58

Tissus Naturels - coton ou lin  
*Natural fabrics*

p. 60

Protège-table & Juponnage  
*Table protectors & table skirts*

p. 62-63



# LAVABLE À L'ÉPONGE

SPONGE WASHABLE



Les Imperméables

Waterproof fabrics

# LAVABLE EN MACHINE

MACHINE WASHABLE



Sans  
repassage

No ironing



Les Imprimables

Les Atypiques

Printables / Atypical

Avec  
repassage

Ironing

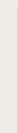

Les Basiques

Les Naturels

Basics / Natural

Comment choisir  
mes nappes ?

How do I choose my tablecloths?





# 8

# Finitions

Finishings



Coupe laser  
Laser cut



Surpiqûre  
Topstitching

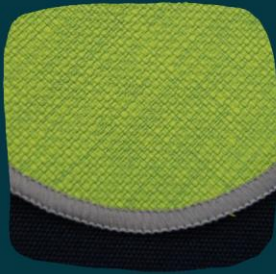

Bourdon  
Bourdon stitch



Ourlet  
Hem



Biais  
Binding



Revers de  
5, 10, 15 ou 20cm  
Border



Coins Cravatte  
Tie corner



Elastiqué  
Elasticated

# Les tissus imperméable (100% PVC effet tissu ou effet cuir)

## Sonoclean



### On adore:

- Imperméable
- Lavable à l'éponge
- Lavable machine 40°C



### Caractéristiques:

100% PVC aspect tissu ou cuir  
Largeur: 140cm  
Poids: 550gr/m2

SANS REPASSAGE

### Idéal pour:

Restaurants  
Traiteur  
Collectivités

48 coloris  
(voir pages 3-4)

## Sonoskaï



### On adore:

- Imperméable
- Lavable à l'éponge
- Les coloris tendance
- Lavable machine 30°C



### Caractéristiques:

100% PVC aspect cuir grainé  
Largeur: 140cm  
Poids: 400gr/m2

SANS REPASSAGE

### Idéal pour:

Restaurants  
Traiteur  
Collectivités

16 coloris  
(voir pages 5-6)

## Sonotan



### On adore:

- Imperméable
- Lavable à l'éponge
- Lavable machine 30°C
- Effet vrai cuir épais



### Caractéristiques:

100% PVC aspect cuir épais  
Largeur: 140cm  
Poids: 950gr/m2

SANS REPASSAGE

### Idéal pour:

Gastronomie  
Set et tapis de table  
(à la dimension du plateau de table)

5 coloris  
(voir pages 7-8)

## Sonosun

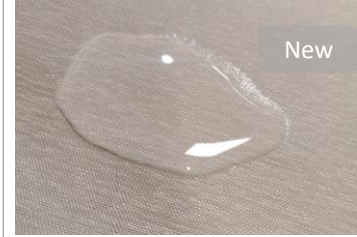

### On adore:

- Imperméable
- Résiste aux UV et au sel
- Antibactérien
- Lavable à l'éponge
- Lavable machine 30°C



### Caractéristiques:

80% PVC aspect tissu  
20% Polyester  
2% Polyuréthane  
Largeur: 140cm  
Poids: 620gr/m2

SANS REPASSAGE

### Idéal pour:

Bord de plage / piscine  
Terrasse





Ecrú



Taupe

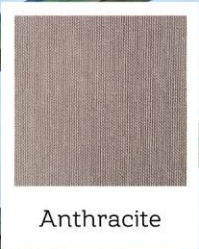

Anthracite



Gris

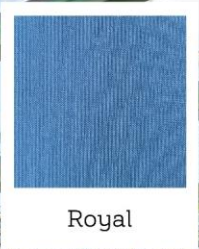

Roya

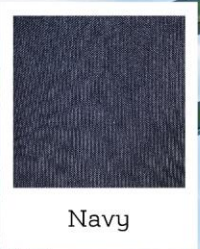

Navy



Jade

# Gamme Zonosun

Résistant UV, pluie, huile, sel  
**Antibactérien**, sans phtalate

UV, rain, oil, salt resistant  
**Antibacterial**, phthalate free

98%% PVC 2% Polyuréthane

Largeur, width: 150cm  
Poids, weight: 620gr/m<sup>2</sup>

Lavable à l'éponge  
Sponge washable  
Lavable à 30°C / 800T/mn  
Washable at 30°C / 800 rpm

Spécial outdoor, résistant aux UV  
Special outdoor, UV resistant, waterproof



# Les tissus imprimables (100% polyester, sans repassage)

## Linélys



### On adore:

- Déperlant
- Effet lin naturel



### Caractéristiques:

100% polyester **effet lin**  
 Largeur: 145cm ou 300cm  
 Poids: 220gr/m2  
 SANS REPASSAGE

Blanc

Vanille

Beige

### Idéal pour:

Restaurants  
 Gastronomie  
 Collectivités

(Coloris à imprimer sur fond blanc, vanille ou beige)

## Tamilys



### On adore:

- Effet coton
- Idéal pour serviettes



### Caractéristiques:

100% polyester **effet coton**  
 Largeur: 150cm  
 Poids: 220gr/m2  
 NON-FEU / SANS REPASSAGE

### Idéal pour:

Restaurants  
 Collectivités

## Magilys

### Déperlys Antiglys

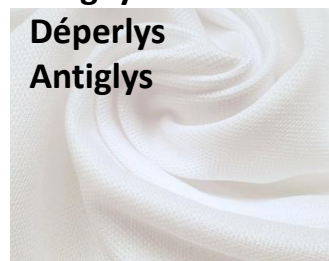

### On adore:

- Léger, fluide
- Sèche en 10mn



### Caractéristiques:

100% polyester **effet maille**  
 Largeur: 150 et 175cm  
 Poids: 220gr/m2  
 SANS REPASSAGE

### Idéal pour:

Bistrots  
 Collectivités  
 Traiteur  
 Evènementiel  
 Terrasse

## Idéalys



### On adore:

- Imperméable
- Lavable à l'éponge



### Caractéristiques:

100% polyester **enduit**  
 Largeur: 145cm  
 Poids: 240gr/m2  
 NON-FEU / SANS REPASSAGE

### Idéal pour:

Bistrots  
 Collectivités  
 Terrasse

+ de dessins dans notre catalogue

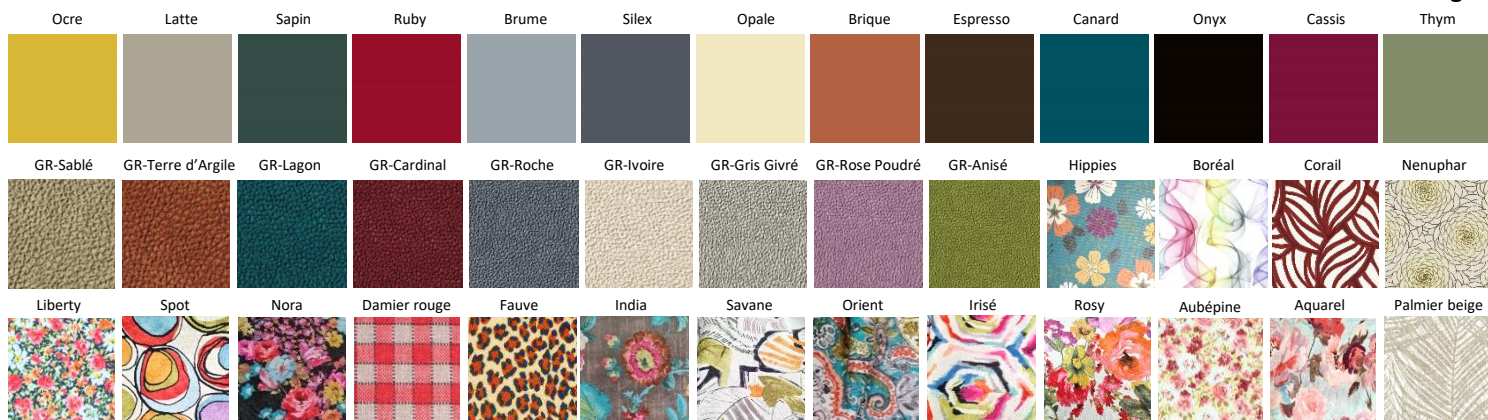



Pissenlit



Aquarelle



Lotus Jaune

Lotus  
Bleu



Madras



Corail



Portail



Balnéo Rouge



Irisé



Nénuphar



Savane



Palmier Beige

Palmier  
Gris



Aérobic



Dentelle



Onde



Arc-en-ciel



India



Nora



Quadro



Marin



Boréal



Iris



Exotic



Spot



Rosy



Orient



Hippies



Aubépine



Kenzo Rose



Liberty



Eole Pierre



Sérénade



Saison

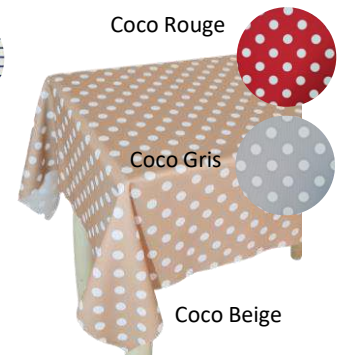
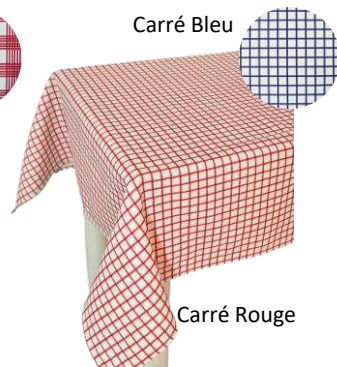
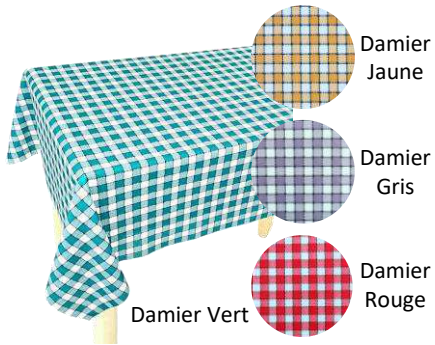

# Les tissus Atypiques (100% polyester, sans repassage)

## Velys



### On adore:

- Style vintage, convivial
- Linge de table & tabliers



### Caractéristiques:

100% polyester **velours côtelé**  
 Largeur: 140cm  
 Poids: 330gr/m2  
 SANS REPASSAGE

### Idéal pour:

Restaurants  
 Gastronomie

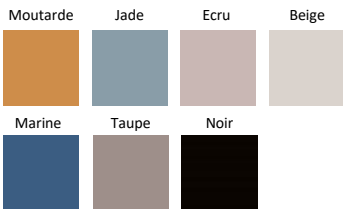

## Sonostyle



### On adore:

- Effet laine, style cosy
- Traitement déperlant



### Caractéristiques:

100% polyester **effet laine**  
 Largeur: 138cm  
 Poids: 420gr/m2  
 SANS REPASSAGE  
 Traitement TEFLON

### Idéal pour:

Restaurants  
 Gastronomie



## Cuirlys



### On adore:

- Effet peau tannée, vieillie
- Doux au toucher



### Caractéristiques:

100% polyester **aspect peau**  
 Largeur: 140cm  
 Poids: 235gr/m2  
 SANS REPASSAGE

### Idéal pour:

Bistros  
 Restaurants



## Facilys (outdoor)



### On adore:

- Effet satiné, sobre, lumineux
- Résiste aux UV



### Caractéristiques:

100% polyester **grande largeur**  
 Largeur: 320cm  
 Poids: 200gr/m2  
 REPASSAGE FACILE  
 Traitement TEFLON

### Idéal pour:

Restaurants  
 Gastronomie  
 Terrasse  
 Bord de mer / Piscine







Grand Carreau  
Rouge



Grand Carreau  
Beige



Petit Carreau  
Beige



Petit Carreau  
Rouge



Chevron Beige



Chevron Rouge



Chevron Gris



Chevron Taupe

# Gamme *Sonostyle*

100% polyester effet laine  
*Wool effect polyester*



Sans repassage, Teflon®  
*No ironing, Teflon treatment*

Largeur, *width*: 138cm  
Poids, *weight*: 420gr/m<sup>2</sup>

Lavable à 30°C / 800T/mn  
*Washable at 30°C / 800 rpm*

# Les tissus Basiques (Polycoton)

## Sonochic



### On adore:

- Traitement déperlant
- Tissu jacquard réversible



### Caractéristiques:

75% polyester 25% coton  
 Largeur: 280cm  
 Poids: 230gr/m2  
 SANS REPASSAGE  
 Traitement TEFLON

### Idéal pour:

Restaurants  
 Gastronomie  
 Collectivités

Trèfle Perle    Mirage perle    Canisse perle



Trèfle Ecu    Mirage Ecu    Canisse Ecu



## Demilys



### On adore:

- Doux au toucher
- Passe en calandre



### Caractéristiques:

50% polyester 50% coton  
**Sobre et raffiné**  
 Largeur: 280cm  
 Poids: 240gr/m2

### Idéal pour:

Restaurants, Traiteur  
 Gastronomie  
 Serviettes de table



## Sonomixt



### On adore:

- Repassage superflux
- Grande largeur 280cm



### Caractéristiques:

50% polyester 50% coton  
**Effet nid d'abeille**  
 Largeur: 280cm  
 Poids: 225gr/m2

### Idéal pour:

Bistrots, Restaurants  
 Collectivités  
 Serviettes de table



## Sodenim



### On adore:

- Style industriel / Casual
- Coton épais, délavé

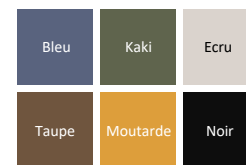

### Caractéristiques:

80% coton 20% polyester  
 Largeur: 150cm  
 Poids: 470gr/m2

### Idéal pour:

Restaurants / Gastronomie  
 Panières / Tabliers

## Sonojean



55% coton 45% coton

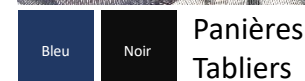

Panières  
 Tabliers

# Gamme *Sonojean*



55% Coton  
45% Polyester

Largeur/Width: 300cm  
Poids/Weight: 280gr/m<sup>2</sup>

Sobre et raffiné  
Sober and elegant

Lavable à 40°C - 800T/mn  
Washable at 40°C - 800 rpm

Faible repassage  
Light ironing



Bleu Foncé

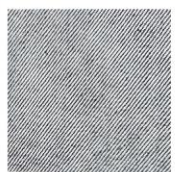

Bleu Clair

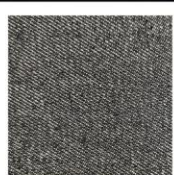

Noir

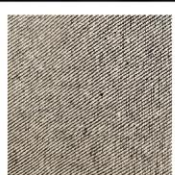

Gris

Bicolore réversible  
*Reversible 2 tones*

# Les tissus Naturels / Natural fabrics

## Sonobio



### On adore / We love:

- Issu d'agriculture bio  
*Organic product*
- Naturellement moucheté  
*Naturally speckled*



### Caractéristiques:

100% Coton biologique  
*Organic cotton*  
Largeur/Width: 230cm  
Poids/Weight: 285gr/m<sup>2</sup>

### Idéal pour:

Restaurants  
Gastronomie/*Gastronomy*

Coton naturel non traité

## Purelys



### On adore / We love:

- Sobre et raffiné  
*Sober and refined*
- Grande largeur  
*Large width*



### Caractéristiques:

100% coton / *Cotton*  
Largeur/Width : 280cm  
Poids/Weight : 230gr/m<sup>2</sup>

### Idéal pour:

Bistrot  
Restaurants  
Traiteur



## Solin



### On adore / We love:

- Lin froissé naturel  
*Natural creased linen*
- Souple et doux  
*Flexible and soft*



### Caractéristiques:

100% lin / *Linen*  
Largeur/Width : 280cm  
Poids/Weight : 220gr/m<sup>2</sup>

### Idéal pour:

Restaurants  
Gastronomie



## Nidelys

New



### On adore / We love:

- Coton Nid d'abeille  
*"Honeycomb" cotton*
- Repassage superflu  
*Light or no-ironing required*



### Caractéristiques:

100% coton  
Largeur/Width : 150cm  
Poids/Weight : 230gr/m<sup>2</sup>

### Idéal pour:

Restaurants

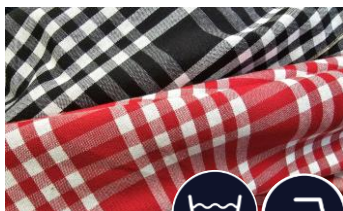

## Bistrot

New

### On adore / We love :

- Son style à la française
- Son côté convivial
- Repassage superflu



### Caractéristiques:

100% coton  
Largeur/Width : 180cm  
Poids/Weight : 210gr/m<sup>2</sup>

### Idéal pour:

Restaurants  
Bistrot  
Serviettes de table  
Panières, Tabliers



Noir



Rouge

# Gamme *Bistrot*

100% Coton

Largeur, width: 180cm

Poids, weight: 210 gr/m<sup>2</sup>

Lavage 40°C - 800T/mn

Retrait de 6%

Repassage non obligatoire  
pour un effet gaufré naturel.



Rouge



Noir

# Les protèges-table

## Effet Bulgom



- Imperméable, Anti-bruit
- Antidérapant



### Caractéristiques:

100% caoutchouc  
Largeur: 138 cm  
Poids: 650gr /m2

Lavable à l'éponge et machine  
à 40°C (1 à 2 fois par an seulement).

## Molleton envers PVC

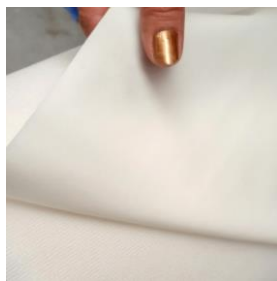

- Imperméable
- Anti-bruit



### Caractéristiques:

100% Polyester envers PVC  
Largeur: 200cm  
Poids: 430gr/m2

Lavable à l'éponge et en machine à 40°C  
Repassage possible sur le polyester.

## Cristalys

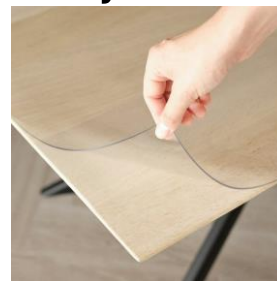

- Imperméable
- Transparent



### Caractéristiques:

100% PVC  
Largeur: 135cm  
Poids: 235gr/m2  
Epaisseur: 0,2mm ou 0,8mm

Lavage à l'éponge uniquement.

## Au choix:

Rouleau



Coupe sur-mesure

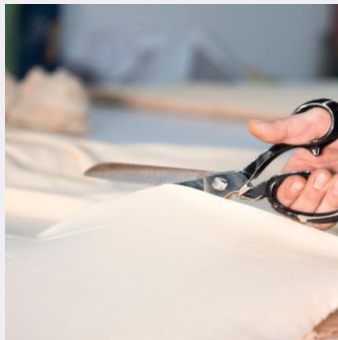

Housse élastiquée



# Juponnage et housse de table

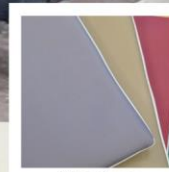

Magilys  
Infroissable

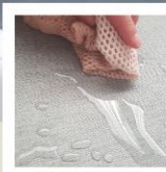

Sonoclean  
Imperméable

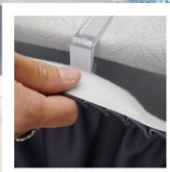

Accroche Clip  
ou Velcro

Fronces

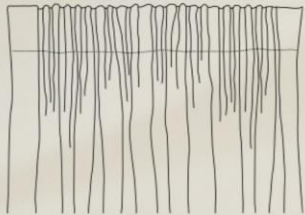

Pli simple

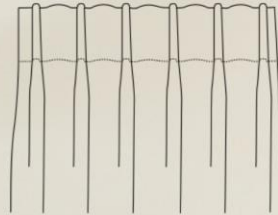

Pli inversé

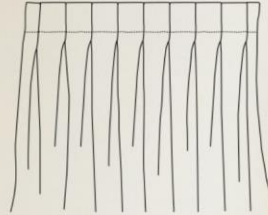

Sur-mesure ou par module de 4 mètres.

Couvercle



Conférence



Housse rectangle



Housse ronde



# LAVAGE PAR PRESTATAIRE EXTÉRIEUR

EXTERNAL CLEANING SERVICE

DEMILYS P.67  
SONOMIXT P.67  
PURELYS P.68  
SONOTEX P.68

# LAVAGE PAR MES SOINS

WASHING BY MYSELF

Sans repassage No ironing		Avec repassage Ironing	
LINELYS	P.66	DEMILYS	P.67
TAMILYS	P.66	SONOTEX	P.68
SONOMIXT	P.67	PURELYS	P.68
BOHEME	P.69	SONOBIO	P.69
NIDELYS	P.69	SOLIN	P.60
BISTROT	P.60		

Comment choisir  
mes serviettes ?

How do I choose my napkins?



# Les serviettes

## Napkins

*Comment choisir mes serviettes ?* p. 64  
*How do I choose my napkins ?*

Serviettes polyester p. 66  
*Polyester napkins*

Serviettes polycoton p. 67  
*Polycotton napkins*

Serviettes coton p. 68-69  
*Cotton napkins*

Serviettes à couverts p. 70  
*Cutlery napkins*

Liteaux & Maniques p. 71  
*Bottle napkins & Potholder*

Serviettes Invités & Bavoires p. 72-73  
*Guest Towel & Bibs*



# Serviettes Polyester



50x50cm

45x45cm

40x40cm

Option bicolore

**LINÉLYS** Polyester aspect lin  
*Linen effect polyester*

**TAMILYS** Polyester aspect coton  
*Cotton effect polyester*

Coloris de base



Blanc

Blanc Cassé

Vanille

Beige

Coloris de base



Blanc

Coloris à imprimer (unicolore ou bicolore)



Ocre

Latte

Sapin

Ruby

Brume

Silex

Opale

Brique

Espresso

Canard

Onyx

Cassis

Thym

Serviettes  
fantaisies:  
voir nos motifs

100% Polyester

Largeur/Width: 150cm  
Poids/Weight: 220gr/m<sup>2</sup>

Lavable à 40°C - 800T/mn  
Washable at 40°C - 800 rpm

Sans repassage  
No ironing

Sèche-linge interdit  
Calandre interdit  
Dryer prohibited



# Serviettes *polycoton*



50% Coton  
50% Polyester

Largeur/Width: 280cm  
Poids/Weight: 240-225gr/m<sup>2</sup>

Lavage industriel autorisé  
Industrial washing allowed

Lavable à 40°C - 800T/mn  
Washable at 40°C - 800 rpm

Faible repassage  
Light ironing

50x50cm

45x45cm

40x40cm

40x60cm

## DEMILYS



Blanc



Ecrû



Beige



Taupe



Chocolat



Charbon



Anis

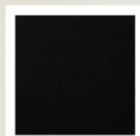

Noir



Jaune

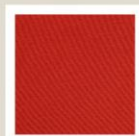

Rouge

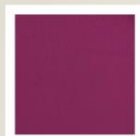

Framboise

## SONOMIXT



Blanc crème



Noir



Gris



Beige



Chocolat



Taupe



Mauve



Bleu



Jaune



Orange



Kaki



Rouge



# Serviettes Coton

## PURELYS

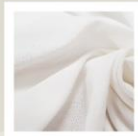

Blanc

100% Coton 230gr/m<sup>2</sup>

### Dimensions:

- 50x50cm / par 4 pcs
- 45x45cm / par 5 pcs
- 40x40cm / par 5 pcs

**Finition:** 4 ourlets / 4 hems

Lavage industriel autorisé  
Industrial washing allowed

Lavable à 40°C - 800T/mn  
Washable at 40°C - 800 rpm

Repassage / Calandrage  
Ironing / Calendering

50x50cm

45x45cm

40x40cm

## SONOTEX



Blanc Jacquard



Blanc Lisse



Bande Satin

100% Coton 220gr/m<sup>2</sup>

### Dimensions :

- 50x50cm / par 1 pcs

**Finition:** 2 lisières / 2 ourlets  
2 selvedges / 2 hems

Lavage industriel autorisé  
Industrial washing allowed

Lavable à 40°C - 800T/mn  
Washable at 40°C - 800 rpm

Repassage / Calandrage  
Ironing / Calendering

50x50cm

## SONOBIO



Naturellement  
moucheté

100% Coton 285gr/m<sup>2</sup>  
issu d'agriculture bio non traité  
*Not treated organic cotton*

### Dimensions:

- 50x50cm / par 4 pcs
- 45x45cm / par 5 pcs
- 40x40cm / par 5 pcs

**Finition:** 4 ourlets / 4 hems

Lavable à 40°C - 800T/mn  
Washable at 40°C - 800 rpm

Repassage / Calandrage  
Ironing / Calendering

50x50cm

45x45cm

40x40cm

# Serviettes 100% Coton



Lavable à 40°C - 800T/mn  
Washable at 40°C - 800 rpm

Repassage superflu  
Light or no-ironing required

45x45cm

40x40cm

30x30

Ideal serviettes invités  
Perfect for guest towels

## BOHÈME

Gaze de coton gaufrée - 130gr m<sup>2</sup>  
Cotton gauze



Châtaigne (BHCT)



Raisin (BHRA)



Ciel (BHCL)



Ocre (BHOC)



Rouille (BHRL)



Kaki (BHKK)



Lilas (BHLL)



Beige (BHBG)



Blanc (BHBC)

## NIDELYS

Coton "nid d'abeille" - 230gr m<sup>2</sup>  
"Honeycomb" cotton



Châtaigne (NDCT)



Raisin (NDRA)



Ciel (NDCL)



Ocre (NDOC)



Rouille (NDRL)



Kaki (NDKK)



Lilas (NDLL)



Beige (NDBG)



Blanc (NDBC)

# Serviette à couverts

Option logo:  
gravure laser ou  
sérigraphie couleur

50x50cm

45x45cm

40x40cm



Tissu au choix  
(voir pages 64-69)

*Fabric of your choice  
(see pages 64-69)*

## Modèle Losange

## Modèle à Pression



## Modèle 1 Rabat



# Liteau à enfiler

Personnalisable  
Customizable



# Manique doublée



Dimensions: 20x20cm  
Epaisseur / Thickness: 5mm

50x50cm

45x45cm

40x40cm

40x60cm

Disponible en version classique sans œillet  
Available in classic version without eyelet

## DEMILYS

Polycoton sobre et raffiné  
Sober, refined polycotton



Blanc



Ecriu



Beige



Taupe



Chocolat



Charbon



Anis



Noir



Jaune



Rouge



Framboise

## SONOMIXT

Polycoton effet nid d'abeille  
Polycotton honeycomb effect



Blanc crème

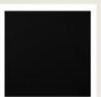

Noir



Gris



Beige



Chocolat



Taupe



Mauve



Bleu



Jaune



Orange



Kaki



Rouge

## SONOJEAN

Polycoton style jean  
Denim-effect polycotton



Bleu Foncé



Bleu Clair



Noir



Gris

# Bavoirs Enfant

# Serviette Invité

Elastique  
à enfiler



2ème âge: 38x30cm

100% Coton éponge bouclette

Largeur/Width: 148cm  
Poids/Weight: 400gr/m<sup>2</sup>

Certification Oeko Tex  
Standard 100 Classe 1

Lavable à 40°C - 800T/mn  
Washable at 40°C - 800 rpm

Laver 3 fois séparément au début  
Sèche-linge programme délicat  
Non javellisable

*Wash 3 times separately first  
Delicate program dryer  
Non bleachable*

30x30cm - 30x50cm

Confectionné  
en France

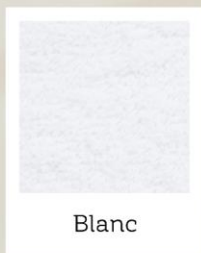



# Bavoirs Adulte



Tissus & coloris  
au choix:

Dimensions: 40x60cm  
Idéal restaurants / collectivités

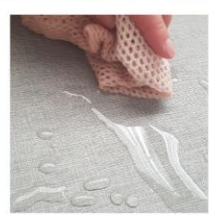

Sonoclean  
Lavable éponge

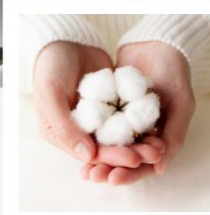

Demilys  
Polycoton



Eponge  
Coton

A nouer



A pression



A oeillet



à personnaliser



# Rideaux, coussins *chemin de lit*

Curtains, cushions, bed runners



# L'Ameublement

## Furnishings

Gamme SOVELVET  
*Velvet range*

p. 77

Gamme BLACKLYS - occultant  
*Blackout range*

p. 79

Tissus à motifs  
*Patterned fabrics*

p. 80

Les confections  
*Types of garments*

p. 81

Les embrasses  
*Tiebacks*

p. 82

Les voilages  
*Veiling*

p. 83

Coussins décoratifs  
*Decorative cushions*

p. 84

Plaids - Gamme DOULYS  
*Plaids*

p. 85





Gamme  
*Sovelvet*

100% Velours polyester  
*Velvet polyester*

Traitement non-feu  
*Flame retardant treatment*

Lavable à 40°C  
*Washable at 40°C*



NAPPE  
TABLECLOTH

RIDEAUX  
CURTAIN

COUSSINS  
CUSHION

# OUILLETS



Flore Ciel

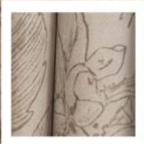

Flore Choco



Flore Rose

# COLORIS



Rose



Olive



Chocolat



Ciel



Flore Olive

# Gamme *Blacklys*

70% Polyester  
30% Polyester recyclé

Largeur/Width: 280cm  
Poids/Weight: 290gr/m<sup>2</sup>

Traitement non-feu  
*Flame retardant treatment*

Lavable à 40°C - 800T/mn  
*Washable at 40°C - 800 rpm*

Sans repassage  
*No need to iron*

Occultant réversible: aspect lin & satin  
*Reversible blackout: linen & satin look*

RIDEAUX  
CURTAIN

CHEMIN LIT  
BED RUNNER

COUSSIN  
CUSHION

# COLORIS



Taupe



Olive



Acier



Soleil



Ecru



Lagon



# Les tissus imprimables (100% polyester, sans repassage)

## Linélys



### On adore:

- Traitement non-feu M1
- Effet lin naturel



### Caractéristiques:

100% polyester **aspect lin**  
 Largeur: 145cm ou 300cm  
 Poids: 220gr/m2  
 SANS REPASSAGE

### Idéal pour:

Restaurants  
 Hôtellerie  
 Collectivités

(Coloris à imprimer sur fond blanc, vanille ou beige)



## Tamilys



### On adore:

- Traitement non-feu M1
- Effet coton



### Caractéristiques:

100% polyester **aspect coton**  
 Largeur: 150cm  
 Poids: 220gr/m2  
 SANS REPASSAGE

### Idéal pour:

Hôtellerie  
 Collectivités

## Firelys



### On adore:

- Traitement non-feu M1
- Léger, fluide



### Caractéristiques:

100% polyester **aspect maille**  
 Largeur: 150 et 175cm  
 Poids: 220gr/m2  
 SANS REPASSAGE

### Idéal pour:

Collectivités  
 Evènementiel

## Occultant PVC ou Tissu



### On adore:

- Traitement non-feu M1
- Obscurcissant



### Caractéristiques:

100% polyester  
 Largeur: 145cm  
 Poids: 240gr/m2  
 SANS REPASSAGE

### Idéal pour:

Hôtellerie  
 Collectivités

+ de motifs dans Nappes > Les Imprimables





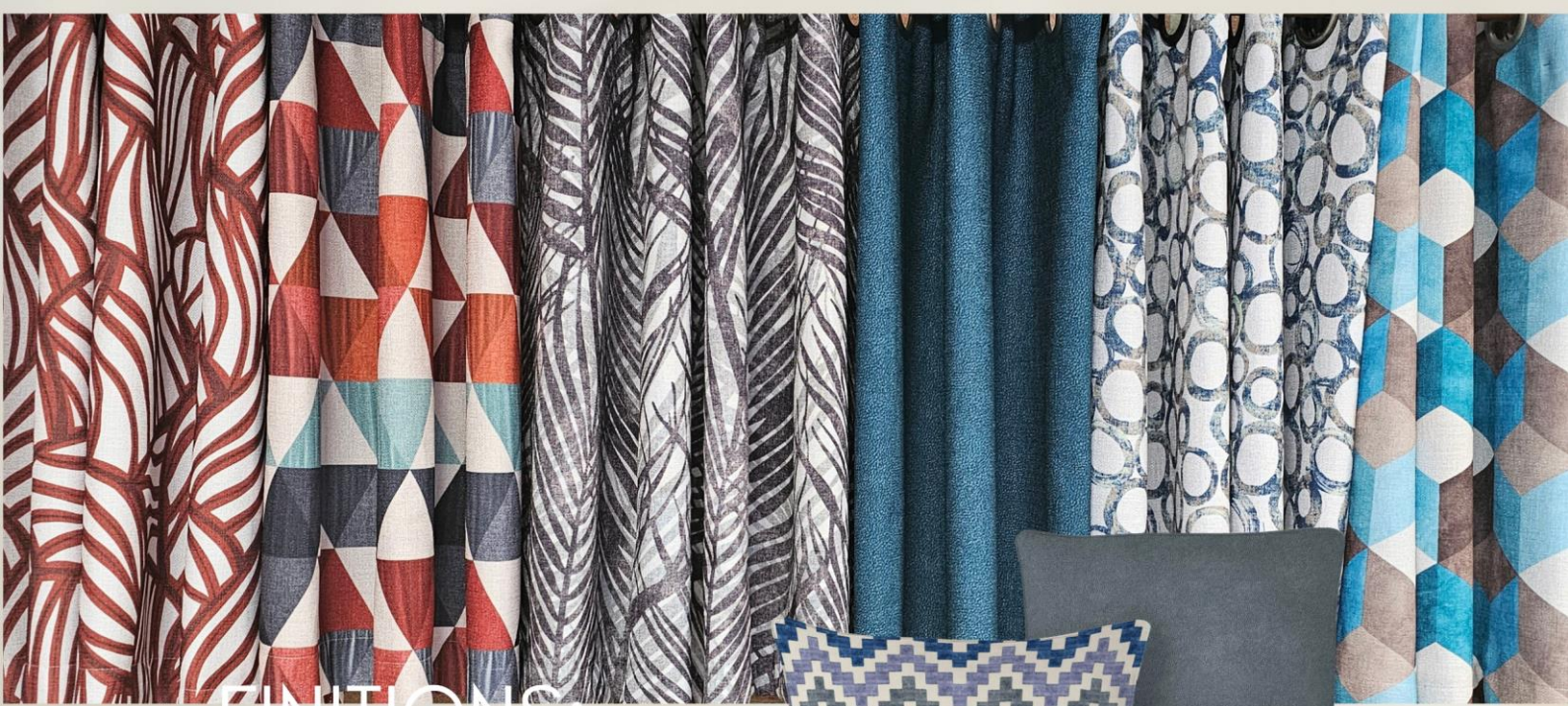

# FINITIONS:



Ruflette à plis



Oeillet

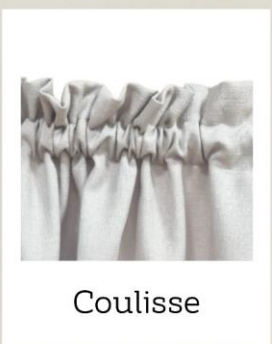

Coulisse



Patte invisible



Tetris

Boréal

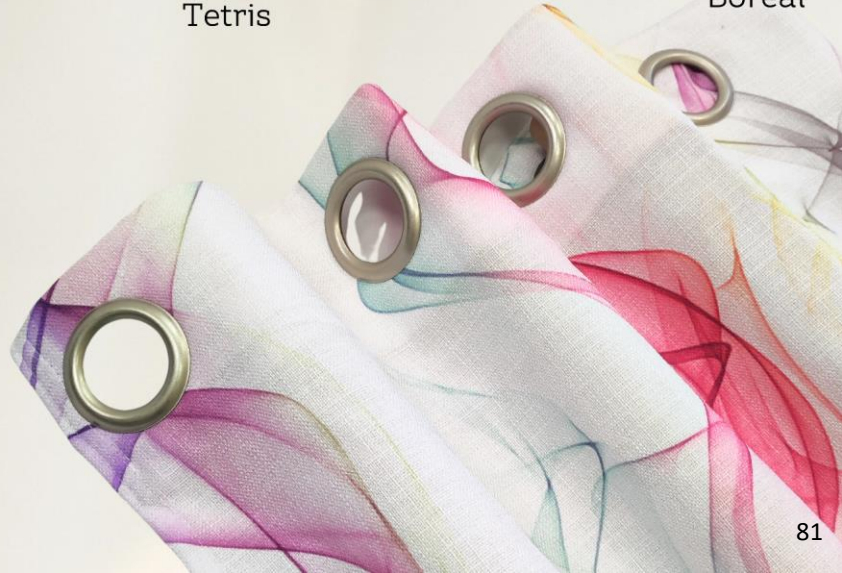

# Embrasses *à rideaux*

## Embrasse en tissu - Gammes Les Imprimables & Atypiques



Bandeau



Romance



Nœud



Papillon

## Embrasse PVC effet cuir - Gamme SONOTAN



Trio



Ceinture



Croisé



Feuille



100% Polyester

Hauteur/Height: 280cm

NON FEU M1  
*Flame-retardant*

Lavage industriel autorisé  
Industrial washing allowed

Lavable à 30°C - 800T/mn  
*Washable at 30°C - 800 rpm*

Infroissable  
*Wrinkle-resistant*

# Voilage *polyester*



Blanc

Ecrû

## 1. Choix du tissu:



Voile



Etamine



Tergal Lin



Option:  
Plombé

## 2. Choix de la confection:



Pli Ruflette



Pli Relief

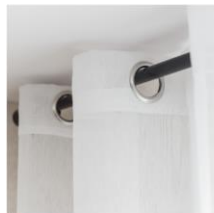

Œillet



Coulisse

# Coussins déhoussable



Enveloppe



Volant droit



Pressions latérales



Passe-poil



Volant plissé



84 Pressions centrales



Confectionné  
en France

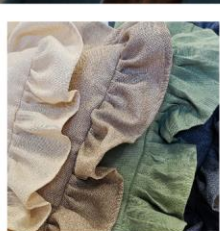

Nos tissus  
au choix

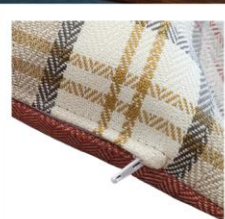

Option zip



Qualité pro

30x30cm

45x45cm

50x50cm

30x50cm

25x40cm

Confectionnés sur-mesure dans notre atelier

# Gamme *Doulyss*

Polaire pour couverture et plaid  
*Fleece for blanket and plaid*

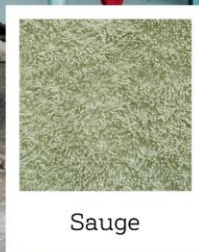

Idéal pour plaid en terrasse  
*Ideal for blanket on terrace*

100% microfibre polyester  
Polyester microfiber fabric

Effet velours polaire  
Fleece velvet effect

Largeur, width: 150cm  
Poids, weight: 260gr/m<sup>2</sup>

Lavable à 30°C / 800T/mn  
*Washable at 30°C / 800 rpm*

# Galette *de chaise*

Réalisations sur-mesure



Non déhoussable  
épaisseur 2cm  
Gamme MAGILYS

Déhoussable  
épaisseur 3 ou 5cm  
TOUTES GAMMES



Option:  
à nouer



Option:  
antidérapant

Galette envers anti-dérapant  
+ coloris: gamme MAGILYS

# Housse *de chaise*

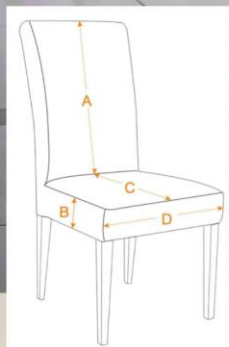

Prise de vos mesures

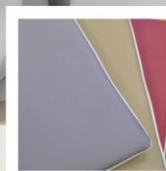

Magilys  
Infroissable

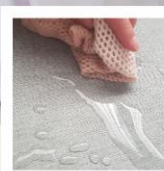

Sonoclean  
Imperméable



Option:  
Bandeau

Droit



Droit court



Pli creux







# Les tabliers

Aprons

La Collection  
*The Collection*

p. 90

Je crée mon tablier  
*I design my apron*

p. 113

Formes & poches  
*Shapes & pockets*

p. 114-115

Tissus & coloris  
*Fabrics & colors*

p. 116-117

Attaches & sangles  
*Fasteners & straps*

p. 118

Personnalisation logo  
*Logo customization*

p. 119



# LA COLLECTION

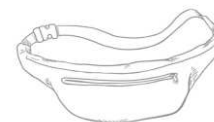

ref. BAN

P.91



P.92

ref. : NOE\_

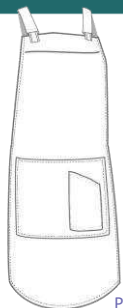

P.96

ref. : BOB\_

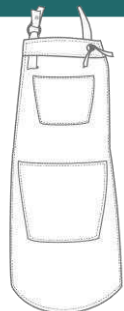

P.96

ref. : MAX\_



P.95

ref. : PIA\_



P.98

ref. : MEO\_

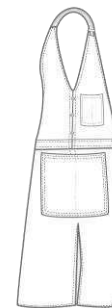

P.95

ref. : GIL\_



P.109

ref. : GED\_

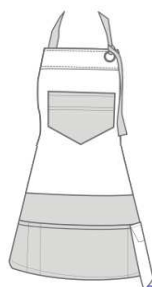

P.109

ref. : NED\_

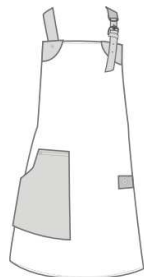

P.98

ref. : POL\_

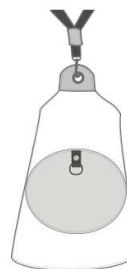

P.100

ref. : ULY\_



P.100

ref. : SID\_

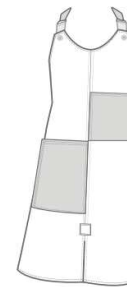

P.94

ref. : ACY\_

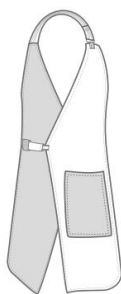

P.99

ref. : PAM\_

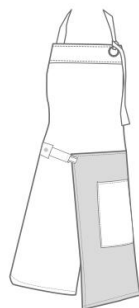

P.99

ref. : POM\_



P.97

ref. : ART\_



P.101

ref. : TAN\_

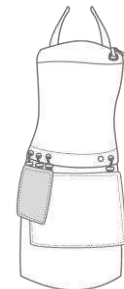

P.94

ref. : KIM

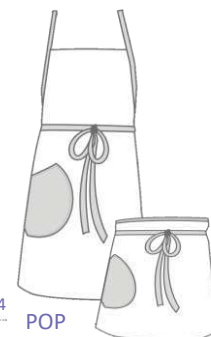

POP  
P.104

FUN  
P.105



P.108

ref. : EDY\_



P.108

ref. : MAE\_



P.102

ref. : BIL\_

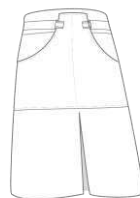

P.102

ref. : FLO\_



P.103

ref. : NIL



P.103

ref. : NAT



Fait main en France  
Handmade in France

# BAN

## Description

- Sacoche bandoulière réglable
- Fermeture éclair
- Contient 1 poche intérieure
- Mixte
- *Adjustable shoulder bag*
- *Zipper closure*
- *Contains 1 inside pocket*
- *Mixed*

Gamme / Range SONOSKAÏ  
100% PVC effet cuir grainé



Gamme / Range CUIRLYS  
100% polyester effet peau tannée





Fait main en France  
Handmade in France



# NOE

Bicolore

## Description

- Tablier mixte. Taille Unique.
- 1 grande poche ventrale
- Tour de cou et sangles ajustables, à nouer.
- *Mixed apron. One size.*
- *1 large ventral pocket*
- *Adjustable straps to tie*



Gamme / Range SONOJEAN  
50% Polyester 50% Coton



Gamme / Range CUIRLYS  
100% polyester effet peau tannée



## Description

- Tablier mixte. Taille Unique.
- 1 grande poche ventrale
- Tour de cou et sangles ajustables, à nouer.
- *Mixed apron. One size.*
- *1 large ventral pocket*
- *Adjustable straps to tie*

# NOE

Unicolore



Bandeau tête en option  
Optional headband



Fait main en France  
Handmade in France

# NOE

Imprimé

## Description

- Tablier mixte. Taille Unique.
- 1 grande poche ventrale
- Tour de cou et sangles ajustables, à nouer.
- Mixed apron. One size.
- 1 large ventral pocket
- Adjustable straps to tie



Ref.: NOE\_LIIND/SKCM



Ref.: NOE\_LIARC/SJFO



Ref.: NOE\_LIIRI/SIAG



Ref.: NOE\_LIAOU/SISR



Ref.: NOE\_LIORI/SJFO



Ref.: NOE\_LISPO/SINR



Ref.: NOE\_LISAV/SIDM



Ref.: NOE\_LICASC/SIKCM



Ref.: NOE\_LIROS/SKCM



Ref.: NOE\_LIBUFBR/SIDM



Fait main en France  
Handmade in France

## Description

- Tablier mixte avec poches amovibles (1 large poche ventrale, 1 petite poche latérale, 1 porte-clé).
- Tour de cou réglable à nouer sur un oeillet.
- Mixed apron with removable pockets (1 large ventral pocket, 1 small side pocket, 1 keychain).
- Adjustable choker to tie on an eyelet.

# KIM

Gamme / Range SONOJEAN  
50% Polyester 50% Coton



Gamme / Range CUIRLYS  
100% polyester effet peau tannée



Gamme / Range SODENIM  
80% coton 20% polyester



## Description

- Tablier mixte.
- 2 poches damier
- Sangles croisées dans le dos.
- Fente de marche
- Mixed apron.
- 2 checkerboard pockets
- Crossed back straps.
- Walking slot

# ACY





Fait main en France  
Handmade in France

## Description

- Tablier mixte.
- Tour de cou par pressions et sangles ajustables, à nouer.
- *Mixed apron.*
- *Adjustable neckband with snaps and tie straps.*

# PIA



Gamme / Range SONOJEAN  
50% Polyester 50% Coton



Gamme / Range CUIRLYS  
100% polyester effet peau tannée



## Description

- Tablier mixte.
- 1 grande poche ventrale
- Tour de cou et sangles ajustables, à nouer.
- *Mixed apron.*
- *1 large ventral pocket*
- *Adjustable straps to tie*

# GIL



Fait main en France  
Handmade in France

## Description

- Tablier mixte . Taille Unique.
- 1 large poche ventrale
- 1 poche poitrine
- Tour de cou réglable, sangles à nouer dans le dos.
- *Mixed apron . One size.*
- *1 large front pocket*
- *1 breast pocket*
- *Adjustable choker, tie-back straps.*

# MAX



Gamme / Range CUIRLYS  
100% polyester effet peau tannée



Gamme / Range SONOCLEAN  
100% PVC effet tissu ou cuir



## Description

- Tablier mixte. Taille Unique.
- 1 large poche ventrale
- 1 poche latérale
- Bretelles élastiquées réglables et croisées dans le dos.
- *Mixed apron. One size.*
- *1 large ventral pocket + 1 lateral*
- *Adjustable elasticated straps, crossed at the back.*

# BOB







Boucle ceinture ajustable  
Adjustable belt buckle



Fait main en France  
Handmade in France

# ART

## Description

- Tablier mixte.
- 2 poches ventrales
- Tour de cou boucle ceinture et sangles ajustables, à nouer.
- Mixed apron.
- 2 ventral pockets
- Adjustable straps to tie



Gamme / Range SODENIM  
80% coton 20% polyester



Gamme / Range CUIRLYS  
100% polyester effet peau tannée



Gamme / Range SONOTAN (cuir synthétique ép.2mm)  
86% PVC - 12% Polyester - 2% Polyurethane



Ref.: ART\_SDNR/TARG



Ref.: ART\_SDMT/TANR



Ref.: ART\_SDCC/TANR



Ref.: ART\_SDKK/TACM



Ref.: ART\_SDEC/TAMN



Ref.: ART\_SDBL/TAAG



Fait main en France  
Handmade in France

## Description

- Tablier mixte.
- 1 poche latérale.
- Tour de cou boucle ceinture et sangles ajustables.
- *Mixed apron.*
- *1 side pocket*
- *Adjustable straps to tie*

# POL

Gamme / Range SONOTAN (cuir synthétique ép.2mm)  
86% PVC - 12% Polyester - 2% Polyurethane



Gamme / Range CUIRLYS  
100% polyester effet peau tannée



Gamme / Range SODENIM  
80% coton 20% polyester



## Description

- Tablier mixte.
- 1 double poche ventrale + 1 petite poche.
- Sangles croisées dans le dos.
- *Mixed apron.*
- *1 double ventral pocket + 1 small pocket*
- *Crossed back straps.*

# MEO





Fait main en France  
*Handmade in France*

## Description

- Tablier Femme.
- 1 poche latérale
- Tour de cou pince bretelle et sangles ajustables, à nouer.
- *Woman apron.*
- *1 side pocket*
- *Adjustable straps to tie*

# PAM



Personnalisable: voir NOS TISSUS  
*Customizable: see OUR FABRICS*

- Les Imperméables / *Waterproof*
- Les Imprimables / *Printables*
- Les Atypiques / *Atypics*
- Les Basiques / *Basics*
- Les Naturels / *Naturals*

## Description

- Tablier mixte.
- 1 poche latérale
- Tour de cou et sangles ajustables, à nouer.
- *Mixed apron.*
- *1 side pocket*
- *Adjustable straps to tie*

# POM





Fait main en France  
Handmade in France

## Description

- Tablier mixte style "Boucher"
- 1 grande poche ventrale Ovale
- Sangles ajustables, à nouer dans le dos.
- *Mixed apron.*
- *1 large ventral pocket*
- *Adjustable straps to tie*

# SID



Gamme / Range SONOTAN (cuir synthétique ép.2mm)  
86% PVC - 12% Polyester - 2% Polyurethane



Gamme / Range CUIRLYS  
100% polyester effet peau tannée



Gamme / Range SODENIM  
80% coton 20% polyester



## Description

- Tablier mixte.
- 1 grande poche ventrale Ovale
- Tour de cou et sangles ajustables, à nouer.
- *Mixed apron.*
- *1 large ventral pocket*
- *Adjustable straps to tie*

# ULY





Fait main en France  
Handmade in France



# TAN

## Description

- Tablier Femme (pince poitrine)
- 1 poche latérale
- Sangles avec boucle ceinture.
- *Woman apron*
- *1 side pocket*
- *Straps with belt buckle.*



Gamme / Range SONOTAN (cuir synthétique ép.2mm)  
86% PVC - 12% Polyester - 2% Polyurethane



Gamme / Range SONOSKAÏ  
100% PVC effet cuir grainé



## Description

- Tablier Homme.
- 1 poche latérale
- Sangles avec boucle ceinture.
- *Woman apron*
- *1 side pocket*
- *Straps with belt buckle.*

# TOM





Fait main en France  
Handmade in France

## Description

- Tablier mixte
- 1 double poche ventrale + 1 latérale
- Bretelles réglables autour de la taille.
- Fente de marche sur le devant.
- *Mixed apron*
- *1 double ventral pocket + 1 side pocket.*
- *Adjustable straps around the waist.*
- *Front walking slot*

# FLO



Gamme / Range SONOJEAN  
50% Polyester 50% Coton



Gamme / Range CUIRLYS  
100% polyester effet peau tannée



Gamme / Range SONOSKAÏ  
100% PVC effet cuir grainé



## Description

- Tablier mixte.
- 1 double poche ventrale + 1 latérale
- Bretelles réglables autour de la taille.
- *Mixed apron.*
- *1 double ventral pocket + 1 side pocket*
- *Adjustable straps around the waist.*

# BIL





Fait main en France  
Handmade in France

## Description

- Tablier mixte
  - 1 double poche ventrale + 1 latérale
  - Sangles à nouer.
- *Mixed apron*
  - *1 ventral pocket + 1 side pocket.*
  - *Straps to tie.*

# NAT



Gamme / Range SONOJEAN  
50% Polyester 50% Coton



Gamme / Range CUIRLYS  
100% polyester effet peau tannée



Gamme / Range SONOSKAÏ  
100% PVC effet cuir grainé



## Description

- Tablier mixte.
- 1 poche latérale
- Sangles à nouer.

- *Mixed apron.*
- *1 side pocket*
- *Adjustable straps to tie.*

# NIL





Fait main en France  
Handmade in France

## Description

- Tablier mixte. Taille Unique.
- 1 poche ronde latérale.
- Tour de cou et sangles ajustables, à nouer.
- *Mixed apron. One size.*
- *1 side round pocket*
- *Adjustable straps to tie*

# POP



ARDOISE  
Ref.: POP SIAR/SINR



BRUME  
Ref.: POP SIBM/SINR



GOLD  
Ref.: POP SIGD/SINR



DAIM  
Ref.: POP SIDM/SINR



AMETHYSTE  
Ref.: POP SIAM/SINR



PAON  
Ref.: POP SIPN/SINR



BRIQUE  
Ref.: POP SIBQ/SINR



CURCUMA  
Ref.: POP SICR/SINR



ARGENT  
Ref.: POP SIAG/SINR



Personnalisable: voir NOS TISSUS  
Customizable: see OUR FABRICS



Fait main en France  
Handmade in France

- Les Imperméables / Waterproof

## Description

# FUN

- Tablier mixte. Taille Unique.
- 1 poche ronde latérale.
- Tour de cou et sangles ajustables, à nouer.

- *Mixed apron. One size.*
- *1 side round pocket*
- *Adjustable straps to tie*

DAIM  
Ref.: FUN SIDM/SINR



GOLD  
Ref.: FUN SIGD/SINR



ARGENT  
Ref.: FUN SIAG/SINR



BRIQUE  
Ref.: FUN SIBQ/SINR



AMETHYSTE  
Ref.: FUN SIAM/SINR



CURCUMA  
Ref.: FUN SICR/SINR



PAON  
Ref.: FUN SIPN/SINR



BRUME  
Ref.: FUN SIBM/SINR



ARDOISE  
Ref.: FUN SIAR/SINR

Personnalisable: voir NOS TISSUS  
Customizable: see OUR FABRICS



Fait main en France  
Handmade in France

- Gamme CUIRLYS



CUIRLYS GRIS  
Ref.: ROB CUGR/SINR

# ROB

## Description

- Tablier mixte
- 1 poche ventrale
- Sangles à nouer.
- Unisex apron
- 1 ventral pocket
- Straps to tie.



CUIRLYS NOIR  
Ref.: ROB CUNR/SINR



CUIRLYS CAMEL  
Ref.: ROB CUCM/SINR



CUIRLYS VANILLE  
Ref.: ROB CUVN/SINR



CUIRLYS CHOCOLAT  
Ref.: ROB CUCC/SINR

## Description

- Tablier mixte.
- 1 poche latérale
- Sangles à nouer.
- Unisex apron.
- 1 lateral pocket
- Adjustable straps to tie.

# KAT





Fait main en France  
Handmade in France

## Description

- Tablier Mixte
- 1 poche ventrale
- à enfiler
- *Unisex apron*
- *1 side pocket*
- *Straps with belt buckle.*

# VAL



Gamme / Range SONOJEAN  
50% Polyester 50% Coton



Gamme / Range CUIRLYS  
100% polyester effet peau tannée



## Description

- Tablier Mixte.
- 1 poche ventrale
- Sangles croisées devant, à nouer dans le dos
- *Unisex apron*
- *1 ventral pocket*
- *Crossed straps at front, tie at back*

# ROZ





Fait main en France  
Handmade in France



# EDY

## Description

- Ceinture tablier mixte
- Multi poches
- Sangles à nouer
- Unisex apron belt
- Multi pockets
- Tie straps



Gamme / Range SONOJEAN  
50% Polyester 50% Coton



Gamme / Range CUIRLYS  
100% polyester effet peau tannée



Gamme / Range SONOSKAÏ  
100% PVC effet cuir grainé



## Description

- Sacoche multi poches
- S'accroche à la ceinture (non fournie) grâce à 2 boutons pressions.
- Multi-pocket bag
- Attaches to belt (not supplied) with 2 snap fasteners.

# MAE





Fait main en France  
Handmade in France



# GED

## Description

- Tablier gilet multipoches
- Sangles à nouer dans le dos
- Bretelles élastiquée réglable pour le tour de cou
- *Multi-pocket vest apron*
- *Tie-back straps*
- *Adjustable elasticized neck straps*

Gamme / Range SONOJEAN  
50% Polyester 50% Coton



Gamme / Range CUIRLYS  
100% polyester effet peau tannée



Gamme / Range SONOSKAÏ  
100% PVC effet cuir grainé



## Description

- Tablier bavette multipoches
- Sangles à nouer dans le dos
- Tour de cou réglable, à nouer
- *Multi-pocket bib apron*
- *Tie-back straps*
- *Adjustable choker with tie*

# NED



# BISTRO

Rouge

## Description

- Tablier Mixte 100% coton
- 1 poche ventrale
- Tour de cou réglable, sangles à nouer
- *Unisex apron, 100% cotton*
- *1 ventral pocket*
- *Adjustable choker, tie straps*

## Description

- Tablier Mixte 100% coton
- 1 poche ventrale
- Tour de cou réglable, sangles à nouer
- *Unisex apron, 100% cotton*
- *1 ventral pocket*
- *Adjustable choker, tie straps*

# BISTRO

Noir





Fait main en France  
Handmade in France

# MAG

NOUVEAU: SANS SANGLES  
se clipe sur vos vêtements!

## Description

- Tablier mixte SANS SANGLES: attaches pinces-clip
  - 1 poche double ventrale
  - 1 clip latéral pour torchon
  - ULTRA LEGER
- 
- *Mixed apron WITHOUT STRAPS: clip fasteners to attach to your clothes.*
  - *1 double ventral pocket*
  - *1 side clip for kitchen towel*
  - *ULTRA LIGHT*



Personnalisable: voir NOS TISSUS  
Customizable: see OUR FABRICS

- Les Imprimables / *Printables*
- Les Atypiques / *Atypics*
- Les Basiques / *Basics*
- Les Naturels / *Naturals*



## Description

- Tablier mixte ample
  - 2 poches latérales
  - Bretelles croisées dans le dos, à enfiler
- 
- *Loose-fitting mixed apron*
  - *2 side pockets*
  - *Slip-on cross-back straps*

# ZEN



# Gamme Maya

## Coton épais

### Mix & Match

- Ext: Pampa écru
- Int: Maya Olive



ART - Maya Olive  
Sangles Camel



ART - Maya Safran  
Sangles Camel



ART - Maya Bleuet  
Sangles Camel



Maya Olive



Maya Safran



Maya Bleuet

100% Coton épais  
Poids: 315 g/m<sup>2</sup>  
Laize: 150cm

Lavable en machine à 30C°  
Essorage 800 T/mn  
Repassage classique

100% Thick cotton  
Weight: 315 g/m<sup>2</sup>  
Width: 150cm

Machine washable at 30C°.  
Spin 800 rpm  
Classic ironing

Autres formes et dimensions,  
nous consulter.



Panière Ø15cm  
Maya Olive



Panière Ø15cm  
Maya Safran



Panière Ø15cm  
Maya Bleuet



Option:  
étiquette personnalisable  
customizable label





# JE CRÉE MON TABLIER

I create my own apron

*Tadam*

The End.



1.

*La Base*

Shape

2.

*Les Poches*

Pockets

3.

*Les Tissus*

Fabrics

4.

*Les Attaches*

Fasteners

5.

*Mon Logo*

Customization

# JE CRÉE MON TABLIER

## 1. Je choisie la base / I choose the base



ref.: NOE\_

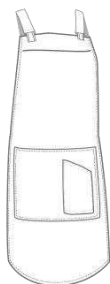

ref.: BOB\_

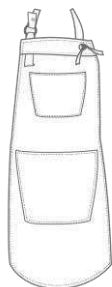

ref.: MAX\_



ref.: PIA\_

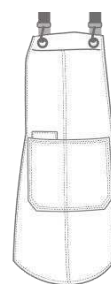

ref.: MEO\_

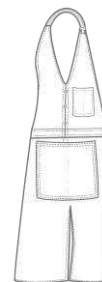

ref.: GIL\_



ref.: GED\_



ref.: NED\_



ref.: POL\_



ref.: ULY\_



ref.: SID\_

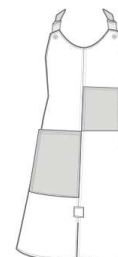

ref.: ACY\_

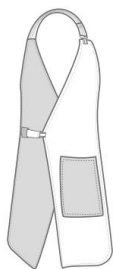

ref.: PAM\_

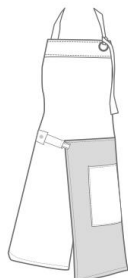

ref.: POM\_



ref.: ART\_

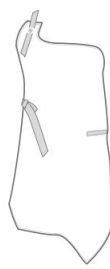

ref.: TAN\_

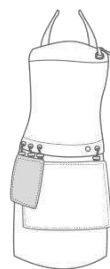

ref.: KIM

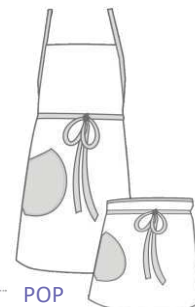

POP

FUN



ref.: EDY\_



ref.: MAE\_



ref.: BIL\_



ref.: FLO\_



ref.: NIL



ref.: NAT



ref.: BAN

# JE CRÉE MON TABLIER

## 2. Avec ou sans poche / With or without pocket

### Les poches poitrine



ref. : PP1\_  
Simple poitrine droite ou gauche  
Single chest pocket, right or left



ref. : PP2\_  
Double poitrine droite ou gauche  
Double chest pocket, right or left



ref. : PP3\_  
Poche poitrine centrale  
Central chest pocket

### Les poches latérales

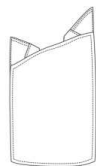

ref. : PL3\_  
Soufflet latérale droite  
Right side bellows pocket



ref. : PL4\_  
Soufflet latérale gauche  
Left side bellows pocket



ref. : PL1\_  
Latérale droite  
Right side pocket

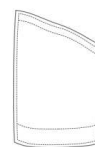

ref. : PL2\_  
Latérale gauche  
Left side pocket

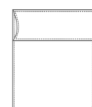

ref. : PL4\_  
Poche à rabat  
Flap side

### Les poches ventrales

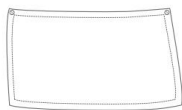

ref. : PV1\_  
Ventrale  
Ventral

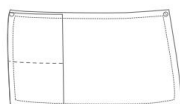

ref. : PV2\_  
Ventrale + Latérale droite  
Ventral + right side pocket

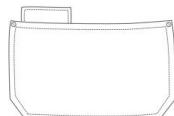

ref. : PV3\_  
Ventrale + sous poche droite  
Ventral + Right side under pocket

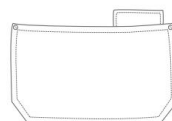

ref. : PV4\_  
Ventrale + sous poche gauche  
Ventral + Left side under pocket

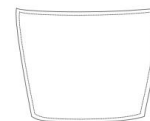

ref. : PV5\_  
Poche ventrale évasée  
Flared ventral pocket

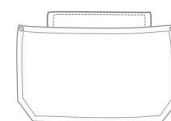

ref. : PV6\_  
Ventrale + sous poche  
Ventral + under pocket

### Les poches ventrales à onglets



ref. : POV1\_  
Ventrale 2 onglets  
2 tabs ventral pocket

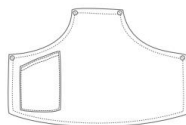

ref. : POV2\_  
Ventrale 2 onglets  
+ poche latérale droite  
2 tabs ventral pocket  
+ right side pocket

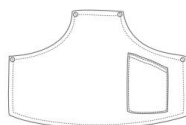

ref. : POV3\_  
Ventrale 2 onglets  
+ poche latérale gauche  
2 tabs ventral pocket  
+ left side pocket



ref. : POV4\_  
Ventrale ovale  
Ventral oval

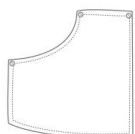

ref. : POL1\_  
Ventrale 1 onglet droit  
1 tab right pocket

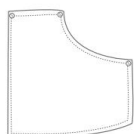

ref. : POL2\_  
Ventrale 1 onglet gauche  
1 tab left pocket

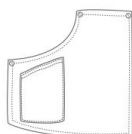

ref. : POL3\_  
Ventrale onglet droit  
+ poche latérale droite  
1 tab right pocket + right side pocket

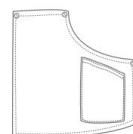

ref. : POL4\_  
Ventrale onglet gauche  
+ poche latérale gauche  
1 tab left pocket + left side pocket

# JE CRÉE MON TABLIER

## 3. Tissus & coloris / Fabrics & colors

### Linélys Uni ou Motif



#### On adore:

- Déperlant
- Effet lin naturel



#### Caractéristiques:

100% polyester **effet lin**  
 Largeur: 145cm ou 300cm  
 Poids: 220gr/m2  
**SANS REPASSAGE**

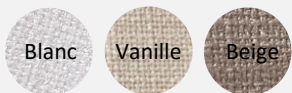

**Coloris** (à imprimer sur fond blanc, vanille ou beige):

### Demilys



#### Caractéristiques:

50% polyester 50% coton  
**Sobre et raffiné**  
 Largeur: 280cm  
 Poids: 240gr/m2

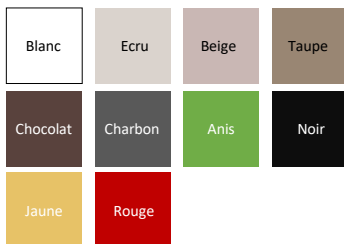

### Sonomixt

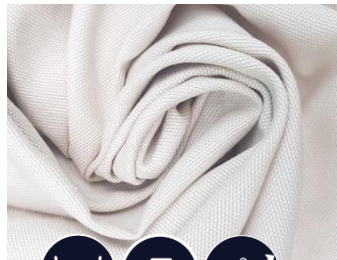

#### Caractéristiques:

50% polyester 50% coton  
**Effet nid d'abeille**  
 Largeur: 280cm  
 Poids: 225gr/m2



### Sodenim

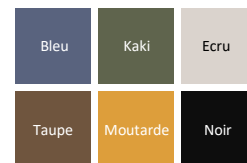

#### Caractéristiques:

80% coton 20% polyester  
 Largeur: 150cm  
 Poids: 470gr/m2

### Sonojean



Bleu	Noir	55% coton 45% coton
------	------	------------------------



# JE CRÉE MON TABLIER

## 3. Tissus & coloris / Fabrics & colors

### Sonoclean

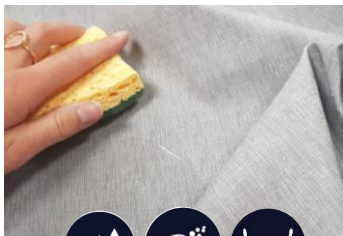

#### Caractéristiques:

100% PVC aspect tissu ou cuir  
Poids: 550gr/m2  
IMPERMEABLE



### Sonoskaï

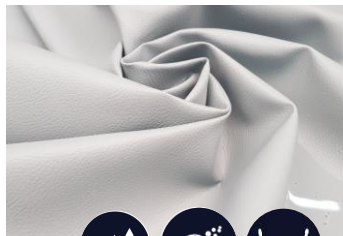

#### Caractéristiques:

100% PVC aspect cuir grainé  
Poids: 400gr/m2  
IMPERMEABLE



### Velys



#### Caractéristiques:

100% polyester velours côtelé  
Largeur: 140cm  
Poids: 330gr/m2  
SANS REPASSAGE

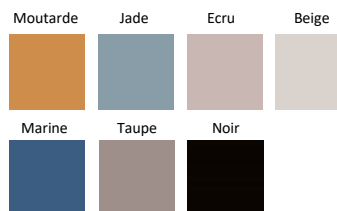

### Cuirlys



#### Caractéristiques:

100% polyester aspect peau  
Largeur: 140cm  
Poids: 235gr/m2  
SANS REPASSAGE



### Sonostyle

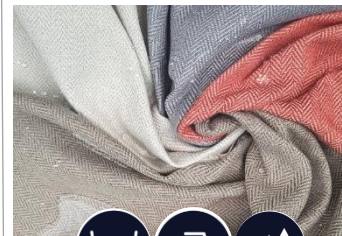

#### Caractéristiques:

100% polyester effet laine  
Largeur: 138cm  
Poids: 420gr/m2  
SANS REPASSAGE  
Traitement TEFLON



### Bistrot



#### Caractéristiques:

100% coton  
Largeur: 180cm  
Poids: 210gr/m2  
Repassage superflu



# JE CRÉE MON TABLIER

## 4. Je choisie le système d'attaches / I choose the fastening system

### Emplacement des sangles:



ou/or



### Fixations réglables:



A nouer sur un œillet  
*To tie on an eyelet*



Pince-bretelle  
*A suspender clip*



Languette à scratch  
*Velcro tongue*



Mousqueton  
*A carabiner*



Boucle ceinture  
*Belt buckle*



Bouton pression  
*Around the neck*

### Coloris des sangles en coton:



Blanc  
*White*



Beige



Taupe



Chocolat  
*Chocolate*



Camel



Bleu  
*Blue*



Noir  
*Black*



Moutarde  
*Mustard*



Kaki



Rouge  
*Red*



Bordeaux



Gris  
*Grey*

# JE CRÉE MON TABLIER

## 5. Je personnalise avec mon logo / I personalize with my logo

Sérigraphie couleur / Colors silkscreen



**Pour cela, nous avons besoin:**

- Fichier haute définition (.AI .EPS .PDF)
- Emplacement et dimensions du logo
- Couleur du logo (si sérigraphie/broderie)

**To do this, we need :**

- High-resolution file (.AI .EPS .PDF)
- Logo location and dimensions
- Logo color (if silkscreen/embroidery)



**Broderie / Embroidery**



**Gravure laser / engraving**

Procédé de marquage par brûlage à l'aide d'un faisceau laser. Marquage permanent et profond. Sans choix de couleur. *Laser beam burning marking process. Permanent, deep marking. No choice of color.*

# SONOLYS



Made in  
France



Personnalisable



Artisanat  
familial



Résistant &  
réutilisable



## CONTACT

+33 3 21 63 16 16  
[valerie@sonolys.com](mailto:valerie@sonolys.com)

---

SONOLYS  
4075 rue de la Lys,  
62840 Sailly-sur-la-Lys  
(Hauts-de-France), France